

Lighting Catalogue_

2026

NOVOLUX LIGHTING

C/ Ramon Berenguer, 8 (Pol. Ind. Can Vinyals)

08130 Santa Perpetua de Mogoda, Barcelona, Spain.

ESPAÑA - PORTUGAL: Tel. +34 93 274 52 52 - info@novoluxlighting.com

EXPORT: Tel +34 93 516 20 05 - export@novoluxlighting.com

FRANCE: Tel. +34 93 516 20 05 - france@novoluxlighting.com

www.novoluxlighting.com

45 *years*

Este año, Novolux Lighting celebra 45 años iluminando proyectos, espacios y trayectorias profesionales.

Desde nuestros inicios en 1981, con el nacimiento de Cristher, hemos evolucionado de forma constante para adaptarnos a un sector en continua transformación, manteniendo siempre un compromiso firme: ofrecer soluciones de iluminación fiables, eficientes y alineadas con las necesidades reales del mercado.

Hoy afrontamos esta nueva etapa desde un proceso de optimización orientado a generar más valor en cada proyecto, mejorando la eficiencia energética y la sostenibilidad para facilitar decisiones más competitivas a nuestros clientes. Una evolución basada en la responsabilidad, el conocimiento y una clara visión de futuro.

This year, Novolux Lighting celebrates 45 years of lighting projects, spaces and professional careers.

Since our beginnings in 1981, with the birth of Cristher, we have constantly evolved to adapt to a sector in continuous transformation, always maintaining a firm commitment: to offer reliable, efficient lighting solutions that are aligned with the real needs of the market.

Today, we are embarking on this new phase with a process of optimisation aimed at generating more value in each project, improving energy efficiency and sustainability to facilitate more competitive decisions for our customers. An evolution based on responsibility, knowledge and a clear vision of the future.



SOMOS NOVOLUX LIGHTING WE ARE NOVOLUX LIGHTING



En Novolux Lighting fabricamos y comercializamos una amplia gama de luminarias de calidad desde 1981, ofreciendo actualmente soluciones globales de iluminación para aplicaciones lumínicas de interior y de exterior.

Con sede central en Barcelona, contamos también con una fábrica en Valencia dedicada a la producción de luminarias decorativas y productos custom. Nuestra red de partners y distribuidores locales abarca Europa, Oriente Medio, Latinoamérica, África y Asia, lo que nos permite tener presencia en más de 40 países. Además, desde 2023, disponemos de una filial en USA y oficinas comerciales en Dubái y Madrid, consolidando nuestra expansión internacional.

Novolux Lighting has been manufacturing and commercialising a wide range of high-quality luminaires since 1981 and, nowadays, it offers global lighting solutions for indoor and outdoor lighting applications.

Headquartered in Barcelona, we also have a factory in Valencia dedicated to the production of decorative luminaires and custom products. Our network of partners and local distributors spans across Europe, the Middle East, Latin America, Africa, and Asia, allowing us to maintain a presence in over 40 countries. Additionally, since 2023, we have a subsidiary in the USA and commercial offices in Dubai and Madrid, further strengthening our international expansion.

LOS VALORES
QUE NOS DEFINEN
THE VALUES
THAT DEFINE US



Innovación y creatividad

Desarrollamos productos de iluminación que combinan funcionalidad, estética y tecnología avanzada en electrónica y control de la luz. Esta integración nos permite ofrecer soluciones únicas que satisfacen las necesidades de nuestros clientes y optimizan el control de la iluminación, mejorando significativamente sus experiencias.

Calidad y excelencia

Mantenemos los más altos estándares de calidad en todos nuestros procesos y productos. Nos esforzamos por alcanzar la excelencia en cada detalle, asegurando que cada luminaria que fabricamos cumpla con las expectativas más exigentes de nuestros clientes.

Sostenibilidad

Estamos comprometidos con la protección del medio ambiente. Trabajamos para reducir nuestra huella de carbono en todas nuestras operaciones, implementando prácticas sostenibles y promoviendo la producción local y responsable.

Pasión por la luz

Nuestra pasión por la luz nos motiva a transformar los espacios y mejorar el bienestar de las personas. Entendemos la iluminación como un elemento vital que realza tanto las características físicas de los entornos como la calidad de vida de quienes los utilizan.

Compromiso y profesionalismo

Nos comprometemos a ofrecer un servicio excepcional y asesoría personalizada por cliente. Nuestro enfoque profesional y dedicado asegura que proporcionamos soluciones lumínicas que cumplen con las especificaciones exactas de cada proyecto, garantizando la satisfacción y confianza de nuestros clientes.

Innovation and creativity

We are committed to continuous innovation, developing lighting products that combine functionality, aesthetics, and advanced light control and electronics technology. This integration allows us to offer unique solutions that meet our customers' needs and optimise lighting control, significantly enhancing their experience.

Quality and excellence

We maintain the highest quality standards in all our processes and products. We strive for excellence in every detail, ensuring that each lighting fixture we manufacture meets the most demanding expectations of our customers.

Sustainability

We are committed to protecting the environment. We work to reduce our carbon footprint in all our operations by implementing sustainable practices and promoting local and responsible production.

Passion for light

Our passion for light drives us to transform spaces and improve people's well-being. We understand lighting as a vital element that enhances both the physical characteristics of environments and the quality of life of those who use them.

Commitment and professionalism

We are committed to providing exceptional service and personalized advice to each customer. Our professional and dedicated approach ensures that we deliver lighting solutions that meet specifications and exceed expectations.

NUESTRAS GAMAS

OUR PRODUCT RANGES

indeluz

Luminarias técnicas de uso interior pensadas específicamente para espacios comerciales, hoteleros y oficinas.

Technical indoor luminaires specifically designed for shops, malls, hotels and offices.

exo

Luminarias versátiles y decorativas de uso interior con enfoque a hospitality y contract.

Versatile and decorative indoor luminaires focused on hospitality and contract.

Dopo

Luminarias de carácter funcional para todo tipo de aplicaciones de exterior.

Functional luminaires for all types of outdoor applications.

Cristher

Luminarias de alta gama para exteriores residenciales y arquitecturales.

High range luminaires for residential and architectural outdoor settings.

CANALED

Soluciones lineales de uso interior para grandes superficies comerciales, aparcamientos, fábricas, almacenes y centros logísticos, infraestructuras ferroviarias y oficinas.

Linear modular lighting solutions of a technical-industrial purpose for indoor use in shopping malls, parking areas, factories, warehouses and logistics hubs, railway infrastructures and offices.

NOVOLUX

CUSTOM LIGHTING

Luminarias decorativas personalizadas para proyectos. Nos adaptamos a cualquier necesidad de fabricación trabajando aluminio, madera, cristal, metacrilato, etc.

Custom-made decorative luminaires for projects. We adapt to any manufacturing need, working with aluminium, wood, glass, methacrylate, etc.

CANALED

La gama Canaled, integrada dentro de Novolux Lighting desde enero de 2023, está especializada en iluminación lineal para grandes superficies comerciales, aparcamientos, fábricas, almacenes y centros logísticos, infraestructuras ferroviarias y oficinas desde sus inicios en 2011. Durante los primeros diez años de existencia de la marca, se instalaron más de 150.000 metros de iluminación lineal Canaled en varios países del mundo y para compañías como Amazon, Carrefour, Lidl, Decathlon, Renfe, Adif, HP, Seat, FNAC, SABA, etc.



Canaled basa su estrategia en la elevada calidad y fiabilidad del producto, la utilización de tecnología de última generación y la innovación continua. También son elementos claves la fabricación km0 y la colaboración con proveedores de proximidad. Con el objetivo de reducir la huella ecológica a la vez que los costes económicos, proponemos una gama de productos de iluminación de bajo consumo y de bajo coste gracias a su fácil fabricación, instalación y mantenimiento.

The Canaled range, integrated into Novolux Lighting since January 2023, has specialised in linear lighting for large shopping centres, car parks, factories, warehouses and logistics centres, railway infrastructures and offices since its inception in 2011. During the first ten years of the brand's existence, more than 150,000 metres of Canaled linear lighting were installed across various countries worldwide, serving companies such as Amazon, Carrefour, Lidl, Decathlon, Renfe, Adif, HP, Seat, FNAC, SABA, among others.

Canaled's strategy is built on high product quality and reliability, the implementation of cutting-edge technology and continuous innovation. Key elements also include local production (km0) and collaboration with proximity suppliers. With the goal of reducing both ecological footprint and economic costs, we offer a range of low-consumption and cost-effective lighting products, designed for efficient manufacturing, easy installation, and minimal maintenance.



Catálogo
Catalogue



NUESTROS EJES ESTRATÉGICOS

OUR STRATEGIC AXES

1

Innovación y tecnología de vanguardia.
Innovation and cutting-edge technology.

2

Personalización, adaptabilidad
y producción local.
Customization, adaptability,
and local production.

3

Excelencia en el servicio.
Excellence in service.

1. Innovación y tecnología de vanguardia

En Novolux Lighting, nos dedicamos a la fabricación y comercialización de luminarias con un enfoque en la innovación y la tecnología de vanguardia. Especialmente en nuestras luminarias técnicas de interior, ofrecemos una amplia gama de opciones de regulación, conectividad, temperaturas de color y potencias. Además, nuestras luminarias técnicas de exterior están diseñadas para ser responsables con el medio ambiente, incorporando tecnologías que minimizan la emisión de luz al hemisferio superior y utilizan temperaturas de color adecuadas para proteger la flora y fauna locales.

Nuestro equipo de I+D y diseño industrial también colabora con diseñadores externos de prestigio para estar siempre a la vanguardia de la innovación tecnológica. Esto nos permite mejorar la salud y el bienestar de los usuarios mediante soluciones lumínicas avanzadas y personalizadas, adaptadas a las necesidades específicas de cada proyecto y espacio.

1. Innovation and cutting-edge technology

At Novolux Lighting, we specialize in the manufacturing and marketing of luminaires with a focus on innovation and cutting-edge technology. Particularly in our indoor technical luminaires, we offer a wide range of options for dimming, connectivity, color temperatures, and power levels. Additionally, our outdoor technical luminaires are designed to be environmentally responsible, incorporating technologies that minimize light emission into the upper hemisphere and utilize appropriate color temperatures to protect local flora and fauna.

Our R&D and industrial design team also collaborates with prestigious external designers to stay at the forefront of technological innovation. This enables us to enhance the health and well-being of users through advanced and customized lighting solutions tailored to the specific needs of each project & space.

2. Personalización, adaptabilidad y producción local

Ofrecemos una amplia gama de opciones de personalización para satisfacer las necesidades específicas de cada cliente y proyecto. Gracias a nuestros talleres de fabricación y montaje propios, podemos crear luminarias decorativas y pantallas en medidas y acabados especiales, asegurando que cada producto sea único y adecuado para su propósito.

Comprometidos con la producción local, apoyamos la industria cercana a nuestros centros productivos, lo que nos permite reducir significativamente nuestra huella de carbono. Esta práctica no solo beneficia al medio ambiente, sino que también fortalece la economía local y garantiza tiempos de entrega más rápidos.

Proveemos soluciones lumínicas únicas, adaptadas a las necesidades específicas de cada proyecto, mejorando tanto la funcionalidad como la estética de los espacios. Nuestra especialización en el sector hospitality, entre otros, junto con la división custom y los estudios lumínicos personalizados que ofrecemos, nos permite crear ambientes que optimizan el confort visual y el bienestar de las personas, especialmente en entornos como hoteles y restaurantes. Con un enfoque en la personalización técnica, desarrollamos proyectos a medida que no solo transforman las ideas de nuestros clientes en realidad, sino que también cumplen con los más altos estándares del sector.

2. Customization, adaptability and local production

We offer a wide range of customization options to meet the specific needs of each client and project. Thanks to our own manufacturing and assembly workshops, we can create decorative luminaires and Shades in special sizes and finishes, ensuring that each product is unique and suitable for its purpose.

Committed to local production, we support industries near our manufacturing centers, allowing us to significantly reduce our carbon footprint. This practice not only benefits the environment but also strengthens the local economy and ensures faster delivery times.

We provide unique lighting solutions tailored to the specific needs of each project, enhancing both the functionality and aesthetics of spaces. Our expertise in the hospitality sector, among others, combined with our custom division and personalised lighting studies, allows us to create environments that optimise visual comfort and people's well-being, especially in settings such as hotels and restaurants. With a focus on technical customisation, we develop bespoke projects that not only bring our clients' ideas to life but also meet the highest standards in the industry.

3. Excelencia en el servicio

En Novolux Lighting, nos apasiona la iluminación y entendemos su impacto como un elemento esencial que no solo mejora las características físicas de los espacios, sino también las actividades que allí se desarrollan y el bienestar de las personas que los habitan o utilizan. Es por ello, que también estamos asociados a diversas entidades del sector para promover la cultura de la luz, subrayando nuestro compromiso con la educación y la excelencia en iluminación.

También tenemos un equipo interno dedicado a ofrecer soluciones lumínicas para cada proyecto. A través de nuestro servicio de asesoría personalizada, analizamos las necesidades específicas de cada cliente para proporcionar respuestas que cumplan con las exigencias de cada obra. Para asistencia personalizada y profesional, puedes contactar con nuestro departamento de proyectos en proyectos@novoluxlighting.com

Por otro lado, proporcionamos un servicio rápido y eficiente, respaldado por un centro logístico de 12.000 m² con capacidad para 10.000 palets, lo que nos permite gestionar grandes volúmenes de pedidos y enviar más de 200 pedidos al día. En nuestros headquarters, también contamos con oficinas centrales, un showroom, una zona de ensamblaje y mecanizados, así como ingeniería especializada en diseño industrial e I+D.

Aseguramos altos estándares de calidad en todos nuestros productos, garantizando la satisfacción del cliente a través de un servicio excepcional y un compromiso inquebrantable con la calidad. Operamos bajo un sistema de gestión de calidad conforme a la norma ISO 9001:2015, certificada por IQNet y AENOR, lo que refuerza nuestro compromiso con la excelencia y la mejora continua en todos nuestros procesos.

3. Excellence in service

At Novolux Lighting, we are passionate about illumination and understand its impact as an essential element that not only enhances the physical characteristics of spaces but also the activities that take place there and the well-being of the people who inhabit or use them. That's why we are associated with various entities in the sector to promote the culture of light, emphasizing our commitment to education and excellence in lighting.

We also have an in-house team dedicated to providing lighting solutions for every project. Through our personalized advisory service, we analyze the specific needs of each client to provide responses that meet the requirements of each work. For personalized and professional assistance, you can contact our project department at proyectos@novoluxlighting.com.

Furthermore, we provide fast and efficient service, backed by a 12,000 m² logistics center with capacity for 10,000 pallets, allowing us to manage large order volumes and ship over 200 orders per day. At our headquarters, we also have central offices, a showroom, an assembly and machining area, as well as specialized engineering in industrial design and R&D.

We ensure high-quality standards in all our products, guaranteeing customer satisfaction through exceptional service and an unwavering commitment to quality. We operate under a quality management system in accordance with ISO 9001:2015, certified by IQNet and AENOR, reinforcing our commitment to excellence and continuous improvement in all our processes.

Colaboraciones – Collaborations



Calidad – Quality





ECOMMERCE B2B



novoluxlighting.com

Con la vocación de ofrecer el mejor servicio a nuestros clientes, Novolux Lighting dispone de un ecommerce B2B que permite a sus usuarios:

Seguimiento de pedidos

Realiza el seguimiento detallado de tus pedidos en tiempo real.

Consulta de stocks

Accede a la disponibilidad actualizada de nuestros productos.

Ofertas y descuentos

Aprovecha grandes descuentos exclusivos para nuestros clientes.

Información de producto

Encuentra toda la información necesaria sobre nuestros productos, desde especificaciones técnicas hasta características detalladas.

Atención en vivo

Disfruta de atención personalizada a través de nuestro servicio de live chat.

Oficina virtual

Gestiona todas tus necesidades comerciales desde nuestra oficina virtual, diseñada para facilitar tu experiencia y optimizar tu tiempo.

Nuestro ecommerce B2B está diseñado para proporcionar una experiencia fluida y eficiente, asegurando que nuestros clientes reciban el mejor servicio posible en cada interacción con Novolux.

Si aún no te has registrado, te invitamos a unirte hoy mismo y descubrir todas las ventajas que tenemos para ofrecerte.

¡Regístrate ahora y lleva tu experiencia con Novolux Lighting al siguiente nivel!

With the commitment to offer the best service to our clients, Novolux Lighting provides a B2B ecommerce platform that allows its users to:

Order tracking

Track your orders in detail in real-time.

Stock Inquiry

Access up-to-date availability of our products.

Offers and discounts

Take advantage of exclusive discounts for our clients.

Product information

Find all the necessary information about our products, from technical specifications to detailed features.

Live support

Enjoy personalized attention through our live chat service.

Virtual office

Manage all your business needs from our virtual office, designed to enhance your experience and optimize your time.

Our B2B ecommerce platform is designed to provide a smooth and efficient experience, ensuring that our clients receive the best possible service in every interaction with Novolux Lighting.

If you haven't registered yet, we invite you to join today and discover all the advantages we have to offer.

Register now and take your experience with Novolux Lighting to the next level!

DOWNLIGHTS



EMPOTRABLES — RECESSED

VIP 1 66 ☞ ∅60 	VIP 1T 70 ☞ ∅78 	VIP 2 74 ☞ 78X78 	VIP 2 76 ☞ 145X78 	VIP 2T 80 ☞ 78X78 
VIP 3 82 ☞ 78X78 	VIP 3 84 ☞ 145X78 	VIP 3T 86 ☞ 78X78 	VIP 1 MINI 88 ☞ ∅ 57 	SCOP 92 ☞ ∅118-176 
QUO 96 ☞ ∅95-145-195 	PALMA ^{IP 65} 102 ☞ ∅ 75 	CARPO ^{IP 65} 106 ☞ ∅ 74 	MINI LUNA 108 ☞ ∅ 85 	NIX 112 ☞ ∅ 65 ☞ ∅ 75 
INEL ^{IP 65} 114 ☞ ∅ 70 	LEDA 116 ☞ ∅ 76 	LEN 118 ☞ ∅ 124 ☞ ∅ 133 	ATOLON 120 ☞ 152 X 152/300/450/600 	

SUPERFICIE — SURFACE

VALGUS 122 	^E BUIIS 124 	HIDRA 126 	BILOG 130 
---	---	---	---

SUSPENSIÓN — PENDANT

HIDRA 128 	BILOG 132 
---	---

LINEAR LIGHTS

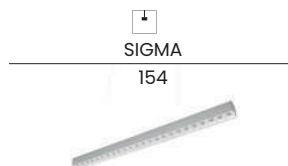
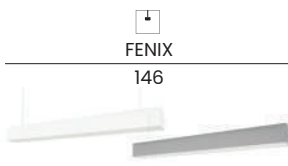
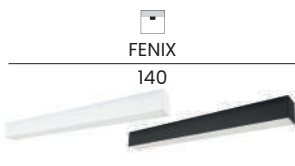
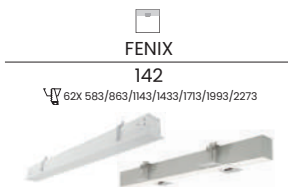
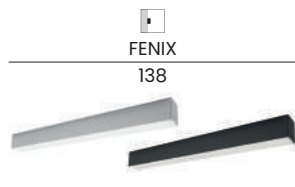

SPOTLIGHTS

PROYECTORES — SPOTLIGHTS

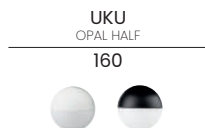

SPOTLIGHTS



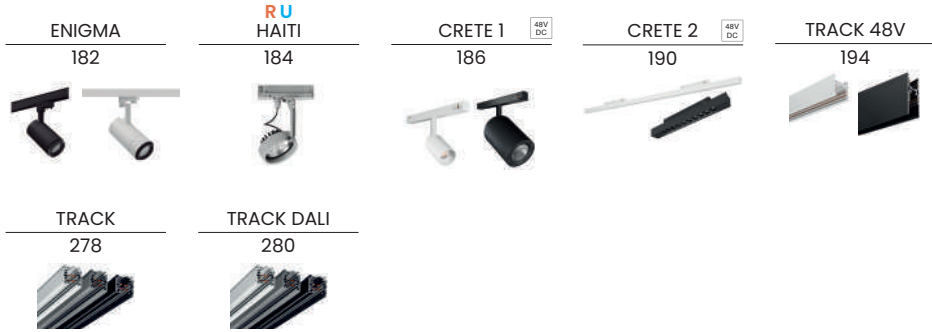

PROYECTORES — SPOTLIGHTS



LED STRIPS



FASTMOVERS

<p>KRAO IP 65</p> <p>242</p> <p>∅ 70-85</p> 	<p>NOK 20</p> <p>244</p> <p>∅ 75</p> 	<p>NOK 30</p> <p>245</p> <p>∅ 75</p> 	<p>ATOLON</p> <p>246</p> <p>152 X 152/300/450/600</p> 	<p>LEN</p> <p>248</p> <p>∅ 133 ∅ 124</p> 
<p>JANO IP 65</p> <p>249</p> <p>∅ 53</p> 	<p>PALMA IP 65</p> <p>250</p> <p>∅ 75</p> 	<p>MINI LUNA</p> <p>251</p> <p>∅ 95</p> 	<p>NIX</p> <p>252</p> <p>∅ 65,72,75</p> 	<p>CARPO IP 65</p> <p>254</p> <p>∅ 74</p> 
<p>INEL</p> <p>254</p> <p>∅ 70</p> 	<p>KOS</p> <p>255</p> <p>∅ 85</p> 	<p>KALE</p> <p>256</p> <p>∅ 98,162</p> 	<p>LEDA</p> <p>257</p> <p>∅ 76</p> 	<p>CALYPSO 3</p> <p>258</p> <p>∅ 70-210</p> 
<p>HIMMEL</p> <p>260</p> 	<p>IBIZA</p> <p>262</p> <p>∅ 55,146</p> 	<p>CARME</p> <p>263</p> 	<p>LAUTAN</p> <p>264</p> 	<p>COVER</p> <p>266</p> <p>∅ 67</p> 
<p>WINDOW 2</p> <p>268</p> <p>∅ 83</p> 	<p>LIGUR</p> <p>269</p> <p>∅ 54 ∅ 55</p> 	<p>OFFICE</p> <p>270</p> 	<p>TEN</p> <p>272</p> 	<p>AMY</p> <p>274</p> 
<p>HAITI</p> <p>276</p> 	<p>TRACK</p> <p>278</p> 	<p>TRACK DALI</p> <p>280</p> 		

WALL LIGHTS

<p>LANTERN 290</p> 	<p>SIGN 292</p> 	<p>TEC 294</p> 	<p>EYE 296</p> 	<p>KRSITA 298</p> 	<p>TOSCA 300</p> 
<p>TANIA 302</p> 	<p>OXY 304</p> 	<p>DIAGONAL 306</p> 	<p>CLASSICAL 308</p> 	<p>AMSTERDAM 310</p> 	<p>CORA 312</p> 
<p>NEMO 314</p> 	<p>COMPACT 316</p> 	<p>FIRENZE 318</p> 	<p>VALAN 321</p> 	<p>ARM 322</p> 	<p>MONTECARLO 324</p> 
<p>BOOK 325</p> 	<p>E DIRK 326</p> 	<p>MINIMAL 328</p> 	<p>SKIN 330</p> 	<p>SERENE 332</p> 	<p>BALTIC 334</p> 
<p>TOSCANA 335</p> 	<p>LEIDEN 335</p> 	<p>E RETT 336</p> 	<p>COOPER 338</p> 	<p>CIRCULAR 340</p> 	<p>DENEB 341</p> 
<p>IONA 342</p> 	<p>BRICK 344</p> 				

PENDANT & CEILING LAMPS

SUSPENSIÓN — PENDANT

TEC
348



FISH
350



TWIST
354



KRISTA
356



OXY
360



FLAKE
367



TOSCA
368



TANIA
372



DIAGONAL
376



VALAN
377



NATURAL
378



THAIS
380



VIETNAM
382



MOLN
384



CORA
386



FIRENZE
388



VORADA
391



FRED
392



A TU ESTILO
396



BAGUET
398



ELGA
400



VINATGE
401



TANNA
402



EASY
404



SUPERFÍCIE — SURFACE

TANIA
370



VORADA
390



FRED
392



VINYL
394

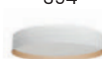

FLOOR & TABLE LAMPS

PIE Y SOBREMESA — FLOOR & TABLE LAMPS

TWIST
408



TEC
410



GEOMETRICAL
412



KRISTA
414



CERAMIC
416



TANIA
418



NEMO
420



DIAGONAL
422



CLASSICAL
424



AMSTERDAM
426



CORA
428



FIRENZE
430



COMPACT
432



WOOD
434



KARA
436



TAICHI
438



SINTRA
440



MANTIS
442



VALAN
444



MONTECARLO
445



BATH

SUPERFÍCIE – SURFACE

TILT
448



BLIZZARD
450



SLEET
452



SHEID
452



CEILING FANS



MISTRAL
456



MISTRAL
458



OUTDOOR

TOSCA
462



FISH
464



NATURAL
466



THAIS
468



VIETNAM
470



NELL
472



WALL LIGHTS

SUPERFÍCIE — SURFACE

<p>FLAT 482</p> 	<p>ORBITA 484</p> 	<p>MURA 486</p> 	<p>EVEN 488</p> 	<p>IKONA 490</p> 
<p>CROMA 491</p> 	<p>SIMIL 492</p> 	<p>LUG 494</p> 	<p>LOOP 495</p> 	<p>ADAY 496</p> 
<p>AVON 496</p> 	<p>CASTELLO 498</p> 	<p>ARLEN 500</p> 	<p>BEAM 502</p> 	<p>RHIN 506</p> 
<p>FROST 508</p> 	<p>CLOUD 508</p> 	<p>CUB 510</p> 	<p>SUEVIS 514</p> 	<p>CAIRO 515</p> 
<p>GUIU 515</p> 	<p>ARTAL 516</p> 	<p>CENADI 516</p> 	<p>CICLON 517</p> 	<p>ABAR 518</p> 
<p>PAMPERO 519</p> 	<p>FLOC 520</p> 	<p>KIRA 522</p> 	<p>ABREGO 523</p> 	<p>GALERNA 523</p> 
<p>ESTEL 524</p> 	<p>STORM 525</p> 	<p>CALM 526</p> 	<p>N BASIC 528</p> 	<p>MIR 529</p> 
<p>PIRO 530</p> 	<p>TEIA 531</p> 	<p>E FAR 532</p> 	<p>KAPPA 535</p> 	<p>DEVON 536</p> 

WALL LIGHTS

EMPOTRABLES — RECESSED

DEVON

537

∇ 96X96 / 180X104 / 284X104



⊕ ∅96



DAMBEL

540

⊕ ∅65X171



LARA

541

⊕ ∅98X160



AMBERES

542

⊕ ∅240X74



XALOC

543

⊕ ∅243X102



WIND

544

⊕ ∅250X50



DONISI

545

⊕ ∅32



RAIN

558

⊕ ∅47



DOWNLIGHTS

SUPERFÍCIE — SURFACE



EMPOTRABLES — RECESSED



UPLIGHTS

EMPOTRABLES — RECESSED



SPOTLIGHTS

PROYECTORES — SPOTLIGHTS

KERO
564



ABADIA
566



NAGORE
566



LULU
568



E
GERONIMO
569



BRANCA
570



BARNI
572



TEVA
574



TERRA
576



CATANIA
578



ARAMO
579



KOBE
580



SEDNA
581



RIGA
582



RIGA RGB
584



BOLLARDS

BALIZAS – BOLLARDS

FLAT

588
H 500/900



ORBITA

590
H 650



IKONA

592
H 400/750



SIMIL

594
H 500



LUG

596
H 350/650



LOOP

598
H 500/1000



AVON

600
H 500



GUIU

602
H 750



SUEVIS

603
H 603



CAIRO

604
H 650



CASTELLO

605
H 495



ADAY

606
H 900/2200



ARLEN

608
H 230



SIBILA

610
H 650/800



ADRANO

612
H 650



ODIN

613
H 250/500



LUA

614
H 478



JASMIN

616
H 650



NATAN

617
H 890



OMO

618
H 300/400/600/800



SIROCO

620
H 650



SAURO

621
H 500/800/1100



ABREGO

622
H 450



GALERNA

623
H 450



SOLAR

ILUMINACIÓN SOLAR — SOLAR LIGHTING

ERGO

626



VERSA

628



LUMBER

630



TONA

632



COMO

634



SOLEI

636



DECORATIVE

DECORATIVA — DECORATIVE

LITTA

640



GLOU

642



PORTOFINO

644



CLASSIC RESIDENTIAL

CLÁSICO RESIDENCIAL — CLASSIC RESIDENTIAL

OTTONE

648



MEDI

649



KEO

649



TROM

650



VIC

660



BOOM

652



CAST

654



INDURA GLOBO

656



GLOBOS Y SOPORTE
(Ø45),(Ø60),(Ø75)

664



GLOBI

661



CLIC CLAC GLOBO

662



POSTES

666



ROUND

669



QUADRA

670



ROB

672



POSTES (Ø45)

675



CLASSIC RESIDENTIAL

CLÁSICO RESIDENCIAL — CLASSIC RESIDENTIAL

CLIC CLAC 4

676



VILLA CHAP

678



CITY INDURA

679



INDURA MEDIUM 4

680



INDURA MINI 4

682



INDURA MINI 6

683



INDURA MEDIUM 6

684



INDURA BIG 6

686



CLIC CLAC 6

688



ELITE 6

690



POSTES

693



VILLA BIG

694



GUNTHER (Ø48),(Ø60)

696



GUNTHER TOP

698



WALL LIGHTS

SUPERFÍCIE — SURFACE

DAU
706



DUOMO
708



BUCKET
710



DION
712



STONE
714



LANCE
718



ISORA
720



BUIT
724



TASCA
728



RIMA
730



SLIM
732



DAIRA
738



PLAFF
739



EMPOTRABLES — RECESSED

RIMA
731
V ∇ ∅124/204 C ∇ 143/223



SLIM
734
V ∇ ∅124/204 C ∇ 143/223



DAIN
736
V ∇ ∅150x150 / ∅280x150



RUA
740
V ∇ ∅156x60/256x60



TRAU
742
V ∇ ∅290x45



COC
744
V ∇ ∅126x273



DOWNLIGHTS

SUPERFÍCIE — SURFACE

DAIRA
738



PLAFF
739



STONE
748



EMPOTRABLES — RECESSED

ATIC

750

☞ ∅90/130/165/210



NABUCO

752

☞ ∅32/50



UPLIGHTS

EMPOTRABLES — RECESSED

CROSCAT

756



NABUCO

758

☞ ∅75



ESTAMBUL

760

☞ ∅92



FOCUS

760

☞ ∅104



MALVA

762

☞ ∅135/212/216/237



NAT-LED

770

☞ ∅80



NODY

771

☞ ∅46/56



GARDA

772

☞ ∅80/135



SURI

774

☞ ∅110



SURI BIG

775

☞ ∅186



WALL WASHERS

BAÑADOR DE PARED — WALL WASHERS

LANCE
778



WALK / WALK RGB
780



WALK / WALK RGB
782



SOLAR

SEÑALIZACIÓN SOLAR — SOLAR SIGNAGE

INTI
786



MITRA
787



SPOTLIGHTS

PROYECTORES — SPOTLIGHTS

FUJI
790



KALOS
792



STONE
794



DISC
796



DADO
898



GIBSON
800



LANCE
802



TIR
804



ABBI
804



BAMBOLA
805



BOLLARDS

BALIZAS — BOLLARDS

PALAU

808

H 500/800



DUOMO

810

H 300/600/900



BUCKET

812

H 300/600



STONE

814

H 535



DION

816

H 250/600/1000

DION bollard
AZI 66696/2020

DAIN

818

H 300/700



TURRET

820

H 500/750



AURA

822

H 260/400/680/2000



MAXIMA

824

H 593/1000/2000/2480/3000



BINDELLA

826

H 650



CLINA

828

H 558



MINI NICO

829

H 65/457



NOVA

830

H 500/650



COK

831

H 320/420/620/820



MIRCO

832

H 280/650













URBAN LIGHTING

ILUMINACIÓN URBANA — URBAN LIGHTING

FANAL 836	VENT 838	FENDER 840	ARYA 842	VICO 843	POSTES 844
					

UNDERWATER LIGHTS

SUMERGIBLES — UNDERWATER LIGHTS

CONTROL RGB 848	^N CONTROL DMX RGB 849	PAR56 850	BELT 850	MINI PRAGA 852
				
PRAGA 852	^N PAL 853	CUP 853	^N GAMBLE 854	FOCUS 855
				

ACCESSORIES

LED T2

858



LED FILAMENT

859



LED PRO

860



G9

860



R7S

860

CONECTORES
CONNECTORS

861

FUENTES DE ALIMENTACIÓN
POWER SUPPLIES

862



GENERAL INFORMATION

ACABADOS
FINISHES

866

MATERIALES
MATERIALS

868

CONSEJOS DE USO E INSTALACIÓN
USAGE AND INSTALLATION TIPS

871

CONSEJOS DE USO E INSTALACIÓN PARA TIRAS LED
USAGE AND INSTALLATION TIPS LED STRIPS

872

PICTOGRAFÍA
SYMBOLOLOGY

874

CONDICIONES GENERALES DE VENTA
GENERAL CONDITIONS OF SALE

880

ÍNDICE DE REFERENCIAS
INDEX OF REFERENCES

882

FAMILY INDEX

A

A TU ESTILO	EXO	396
ABADIA	DOPO	566
ABAR	DOPO	518
ABBI	CRISTHER	804
ABREGO	DOPO	523,622
ADAY	DOPO	496,606
ADRANO	DOPO	612
ALIMENTADORES	ACC.	862,863
AMBERES	DOPO	542
AMPLIFICADOR DMX	CRISTHER	849
AMSTERDAM	EXO	310,426
AMY	INDELUZ	274
ARAMO	DOPO	579
ARLEN	DOPO	500,608
ARM	EXO	322
ARROW	INDELUZ	170
ARTAL	DOPO	516
ARYA	CRISTHER	842
ATIC	CRISTHER	750
ATOLON	INDELUZ	121,246
AURA	CRISTHER	822
AVON	DOPO	496,6

B

BAGUET	EXO	398
BALTIC	EXO	334
BAMBOLA	CRISTHER	805
BARNI	DOPO	572
BASIC	DOPO	528
BEAM	DOPO	502,504
BELGRADO	DOPO	560

BELT	CRISTHER	847
BERNA	DOPO	552
BILOG	INDELUZ	130,132
BINDELLA	CRISTHER	826
BLIZZARD	EXO	450
BOOK	EXO	325
BOOM	DOPO	652
BORA	DOPO	556
BRANCA	DOPO	570
BRICK	EXO	344
BUCKET	CRISTHER	710,812
BUIIS	INDELUZ	124
BUIT	CRISTHER	724,426

C

CAIRO	DOPO	515,604
CALM	DOPO	526
CALYPSO 3	INDELUZ	258
CARME	INDELUZ	263
CARPO	INDELUZ	106,254
CAST	DOPO	654
CASTELLO	DOPO	498,605
CATANIA	DOPO	578
CENADI	DOPO	516
CERAMIC	EXO	416
CICLON	DOPO	517
CIRCULAR	EXO	340
CITY INDURA	DOPO	679
CLASSICAL	EXO	308,424
CLIC-CLAC 4	DOPO	676
CLIC-CLAC 6	DOPO	688

CLIC-CLAC GLOBO DOPO	662	
CLINA	CRISTHER	828
CLOT	DOPO	554
CLOUD	DOPO	508
COC	CRISTHER	744
COK	CRISTHER	831
COMO	DOPO	634
COMPACT	EXO	316,432
CONECTORES	ACC.	861
CONTROL DMX	CRISTHER	849
CONTROL RGB	CRISTHER	848
CONTROLADORES	INDELUZ	230-238
COOPER	EXO	338
CORA	EXO	386,428,312
COVER	INDELUZ	266
CRETE1	INDELUZ	186-189
CRETE2	INDELUZ	190-192
CROMA	DOPO	491
CROSCAT	CRISTHER	756
CUB	DOPO	510,512,547
CUP	CRISTHER	853

D

DADO	CRISTHER	798
DAIN	CRISTHER	736,818
DAIRA	CRISTHER	738
DAMBEL	DOPO	540
DAU	CRISTHER	706
DENEB	EXO	341
DESCOD. DMX	CRISTHER	849
DEVON	DOPO	536-539

FAMILY INDEX

DIAGONAL	EXO	306,376,422
DION	CRISTHER	712,816
DIRK	EXO	326
DISC	CRISTHER	792,796
DONISI	DOPO	545
DUBE	INDELUZ	172
DUOMO	CRISTHER	708,81

E

EASY	EXO	404
ELGA	EXO	400
ELITE 6	DOPO	690
ENIGMA	INDELUZ	182
ERGO	DOPO	626
ESTAMBUL	CRISTHER	760
ESTEL	DOPO	524
EVEN	DOPO	488
EYE	EXO	296

F

FALL	INDELUZ	180
FANAL	CRISTHER	836
FAR	DOPO	532,534
FENDER	CRISTHER	840
FENIX	INDELUZ	138-149
FIRENZE	EXO	318,388,430
FISH	EXO	350,464
FLAKE	EXO	367
FLAT	DOPO	482,588
FLOC	DOPO	520
FOCUS	CRISTHER	760,855

FRED	EXO	392
FROST	DOPO	508
FUJI	CRISTHER	790

G

G9	ACC.	860
GALERNA	DOPO	523,623
GAMBLE	CRISTHER	854
GARDA	CRISTHER	772

GEOMETRICAL	EXO	412
GERONIMO	DOPO	569
GIBSON	CRISTHER	800
GLOBI	DOPO	661
GLOBOS	DOPO	664
GLOU	DOPO	642
GUIU	DOPO	515,602
GUNTHER	DOPO	696-698
GUNTHER TOP	DOPO	699

H

HAITI	INDELUZ	184,276
HIDRA	INDELUZ	126,176
HIMMEL	INDELUZ	260
HIMMEL/SPLAT	INDELUZ	260

I

IBIZA	INDELUZ	262
IKONA	DOPO	490,592
INDURA BIG 6	DOPO	686
INDURA GLOBO	DOPO	656-658
INDURA MEDIUM 4	DOPO	680

INDURA MEDIUM 6	DOPO	684
INDURA MINI 4	DOPO	682
INDURA MINI 6	DOPO	683
INEL	INDELUZ	115,254
INTI	CRISTHER	786
IONA	EXO	342
ISORA	CRISTHER	720-723

J

JANO	INDELUZ	249
JASMIN	DOPO	616

K

KALE	INDELUZ	256
KALOS	CRISTHER	792
KAPPA	DOPO	535
KARA	EXO	436
KEO	DOPO	649
KERO	DOPO	564
KIRA	DOPO	522
KOBE	DOPO	580
KOS	INDELUZ	255
KRAO	INDELUZ	242
KRISTA	EXO	298,356-359,414

L

LANCE	CRISTHER	718,778,802
LANTERN	EXO	290
LARA	DOPO	541
LAUTAN	INDELUZ	264
LED FILAMENT	ACC.	859

FAMILY INDEX

LED PRO	ACC.	860
LED T2	ACC.	858
LEDA	INDELUZ	117,257
LEIDEN	EXO	335
LEN	INDELUZ	119,248
LIGUR	INDELUZ	269
LITTA	DOPO	640
LOOP	DOPO	495,598
LUA	DOPO	614
LUG	DOPO	494,596
LULU	DOPO	568
LUMBER	DOPO	630

M

MALVA	CRISTHER	762-769
MANTIS	EXO	442
MARTINA	DOPO	561
MAXIMA	CRISTHER	824
MEDI	DOPO	649
MINI LUNA	INDELUZ	109,251
MINI NICO	CRISTHER	829
MINI PRAGA	CRISTHER	852
MINIMAL	EXO	328
MIR	DOPO	529
MIRCO	CRISTHER	832
MIST	DOPO	546
MISTRAL	EXO	458
MITRA	CRISTHER	787
MOLN	EXO	384
MONTECARLO	EXO	324,445
MURA	DOPO	486

N

NABUCO	CRISTHER	752,758
NAGORE	DOPO	566
NATAN	DOPO	617
NAT-LED	CRISTHER	770
NATURAL	EXO	378,466
NELL	EXO	472,474
NEMO	EXO	314,420
NILO 5	INDELUZ	210
NILO 8-10	INDELUZ	206-209
NILO BASIC	INDELUZ	204
NILO DUAL	INDELUZ	215
NILO EFFICIENCY	INDELUZ	216
NILO RGB	INDELUZ	212
NILO RGB+W	INDELUZ	214
NIX	INDELUZ	113,252
NODY	CRISTHER	771
NOK20	INDELUZ	244
NOK30	INDELUZ	245
NOVA	CRISTHER	830

O

ODIN	DOPO	613
OFFICE	INDELUZ	270
OMO	DOPO	618
ORBITA	DOPO	484,590
OTTONE	DOPO	648
OXY	EXO	304,360-366

P

PAL	CRISTHER	853
PALAU	CRISTHER	808
PALMA	INDELUZ	103,250

PAMPERO	DOPO	519
PAR56	CRISTHER	850
PERFILES	INDELUZ	224-228
PIRO	DOPO	530
PLAFF	CRISTHER	739
PORTOFINO	DOPO	644
POSTES	DOPO	651,675,693
PRAGA	CRISTHER	852

Q

QUADRA	DOPO	670
QUO	INDELUZ	96,98,100

R

R7s	ACC.	860
RAIN	DOPO	558
RETT	EXO	336
RHIN	DOPO	506
RIGA	DOPO	582,584
RIMA	CRISTHER	730
RINS	INDELUZ	218
ROB	DOPO	672-674
ROUND	DOPO	669
RUA	CRISTHER	740

S

SAURO	DOPO	621
SCOP	INDELUZ	92-94
SEDNA	DOPO	581
SENA	INDELUZ	220
SENA RGB	INDELUZ	221
SERENE	EXO	332

FAMILY INDEX

SHEID	EXO	452
SHINNY	DOPO	550
SIBILA	DOPO	610
SIGMA	INDELUZ	151-155
SIGN	EXO	292
SIMIL	DOPO	492,594
SINTRA	EXO	440
SIO	DOPO	553
SIROCO	DOPO	620
SKIN	EXO	330
SLEET	EXO	452
SLIM	CRISTHER	732-735
SOLEI	DOPO	636
STONE	CRISTHER	714,716,748, 794,814
STORM	DOPO	525
SUEVIS	DOPO	514,603
SURI	CRISTHER	774
SURI BIG	CRISTHER	775

T

TAICHI	EXO	438
TANIA	EXO	302,370,372, 374,418
TANNA	EXO	402
TASCA	CRISTHER	728
TEC	EXO	294,348,410
TEIA	DOPO	531
TEN	INDELUZ	272
TERRA	DOPO	576
TEVA	DOPO	574
THAIS	EXO	380,468
TILT	EXO	448
TIR	CRISTHER	804

TONA	DOPO	632
TOSCA	EXO	300,368,462
TOSCANA	EXO	335
TRACK	INDELUZ	278-281
TRACK 48V	INDELUZ	194-201
TRAU	CRISTHER	742
TROM	DOPO	650
TURRET	CRISTHER	820
TURT	INDELUZ	169
TWIST	EXO	354,408

U

UKU	INDELUZ	161-167
-----	---------	---------

V

VALAN	EXO	321,377,444
VALGUS	INDELUZ	122
VENT	CRISTHER	838
VERSA	DOPO	628
VIC	DOPO	660
VICO	CRISTHER	843
VIETNAM	EXO	382,470
VILLA BIG	DOPO	694
VILLA CHAP	DOPO	678
VINTAGE	EXO	401
VINYL	EXO	394
VIPI	INDELUZ	66
VIPI MINI	INDELUZ	88
VIPI T	INDELUZ	70
VIP2	INDELUZ	74
VIP2 T	INDELUZ	80

VIP3	INDELUZ	82
VIP3 T	INDELUZ	86
VOLGA	INDELUZ	222
VORADA	EXO	390

W

WALK	CRISTHER	780-783
WALKER	DOPO	557
WIND	DOPO	544
WINDOW 2	INDELUZ	268
WOOD	EXO	434

X

XALOC	DOPO	543
-------	------	-----

indelu^z lighting

Técnica de interior | Modularidad | Proyectos versátiles







































Indeluz está orientada a la iluminación técnica de interior, combinando funcionalidad, tecnología y una elevada capacidad de personalización. Su catálogo se adapta a las exigencias de todo tipo de espacios interiores gracias a su enfoque modular y a una producción interna que permite soluciones a medida. Incorpora las últimas tendencias tecnológicas en regulación, conectividad y eficiencia energética. También ofrece productos de alta rotación para proyectos estándar que requieren agilidad y disponibilidad inmediata.

Technical indoor | Modularity | Versatile projects





































Indeluz focuses on technical indoor lighting, combining functionality, technology, and a high level of customisation. Its catalogue adapts to the demands of all types of interior spaces thanks to a modular approach and in-house production, enabling tailor-made solutions. It incorporates the latest technological trends in dimming, connectivity and energy efficiency. It also includes high-turnover products for standard projects that require speed and immediate availability.



























LED lighting

Familia Family	Installation	IP	Potencia Power	CRI	CCT	Highlights	Acabados Finishes
AMY ●	 274	IP20	25W / 30W	CRI>90	● 2700°K ○ 3000°K ○ 4000°K	24°/36°/60° 	
ARROW	 170	IP20	8,8W / 18,6W 24W / 27,4W	CRI>90 CRI>82 CRI>88 CRI>96 CRI>95 CRI>92	● 2700°K ○ 3000°K ○ 4000°K ● 2000°K ● 2500°K ○ 3000°K ○ 3250°K ○ 4000°K	20°/40°/55° DALI CASAMBI	
ATOLON	 120	IP20	17W	CRI>85	○ 3000°K ○ 4000°K	FILTERS option 14°/28° PUSH DALI CASAMBI	
BILOG	 130 132	IP20	44W / 96W	CRI>80	○ 3000°K ○ 4000°K	UGR<19 DALI	
BUIS	 124	IP54	14W / 24W 32W	CRI>80	○ 3000°K ○ 4000°K		
CALYPSO 3 ●	 258	IP54	7W / 13W 18W / 25W	CRI>80	● 2700°K ○ 3000°K ○ 4000°K		
CARME ●	 263	IP44	16,5W / 27,5W	CRI>80	○ 3000°K ○ 4000°K ● 6000°K		
CARPO	 106	IP65	4,7W 10,6W 10,1W-11,8W 15,6W	CRI>90 CRI>97 CRI>95	● 2700°K ○ 3000°K ○ 4000°K ● TW 2700-6500°K ● DIM to WARM 2000-3000°K	UGR<19 LC REG. PUSH/1-10V DALI CASAMBI	
COVER ●	 266	IP44	2W	CRI>80	● 2700°K ○ 3000°K ○ 4000°K	 	
CRETE 1	 186	IP20	6,6W / 11W 12,9W / 18,1W	CRI>90	● 2700°K ○ 3000°K ○ 4000°K	 DALI	
CRETE 2	 190	IP20	7,5W / 15W 6,3W / 12,6W 25,2W	CRI>90	● 2700°K ○ 3000°K ○ 4000°K	 DALI	
DUBE	 172	IP20	9,2W	CRI>80	○ 3000°K	LC REG. 1-10V DALI CASAMBI	
ENIGMA	 182	IP20	25W / 35W	CRI>90 CRI>80	● 2700°K ○ 3000°K ○ 4000°K	 10°-60°	
FALL	 180	IP20	30W 40W 50W	CRI>82	● 2700°K ○ 3500°K ○ 4000°K	 60°-90°	
FENIX	 138 140 142 146	IP20	11,65W / 17,50W 23,30W / 29,15W 34,95W / 40,80W 46,60W	CRI>90 CRI>80	● 2700°K ○ 3000°K ○ 4000°K	108°	

LED lighting

Familia Family	Installation	IP	Potencia Power	CRI	CCT	Highlights	Acabados Finishes	
HAITI		IP20	17W	CRI>85	<ul style="list-style-type: none"> ○ 3000°K ○ 4000°K 	FILTERS option 	14°/28° DALI CASAMBI	
HIDRA		IP20	25W	CRI>90	<ul style="list-style-type: none"> ● 2700°K ○ 3000°K ○ 4000°K 		24°/36°/60° 	
HIMMEL ●		IP20	40W	CRI>80	<ul style="list-style-type: none"> ○ 3000°K ○ 4000°K 			
IBIZA ●		IP44	3,2W	CRI>80	<ul style="list-style-type: none"> ○ 3000°K 			
INEL		IP65	6W / 10W	CRI>90	<ul style="list-style-type: none"> ○ 3000°K ○ 4000°K 		24°/38°/60°	
JANO ●		IP65	7,5W	CRI>90	<ul style="list-style-type: none"> ● 2700°K ○ 3000°K ○ 4000°K 		36° DALI	
KALE ●		IP20	8W / 18,5W	CRI>80	<ul style="list-style-type: none"> ○ 3000°K 		120°/140°	
KRAO ●		IP65 IP44	6,5W / 10,5W / 8W 4,8W / 9W	CRI>80	<ul style="list-style-type: none"> ● 2700°K ○ 3000°K ○ 4000°K 		100° 38°	
LAUTAN ●		IP65	100W 150W 200W	CRI>80	<ul style="list-style-type: none"> ○ 4000°K ● 6500°K 		90° 	
LEDA		IP20	6W / 10W	CRI>90	<ul style="list-style-type: none"> ○ 3000°K ○ 4000°K 		24°/38°/60°	
LEN		IP20	6W / 10W	CRI>90	<ul style="list-style-type: none"> ○ 3000°K ○ 4000°K 		25°/38°/60°	
LIGUR ●		IP44	3W	-	<ul style="list-style-type: none"> ○ 3000°K 			
MINI LUNA		IP20	4,7W 10,6W 10,1W-11,8W	CRI>90 CRI>97 CRI>95	<ul style="list-style-type: none"> ● 2700°K ○ 3000°K ○ 4000°K ● TW 2700-6500°K ● DIM to WARM 2000-3000°K 		UGR<19 L.C REG. PUSH/I-10V DALI CASAMBI	
NIX		IP20	6W / 10W	CRI>90	<ul style="list-style-type: none"> ○ 3000°K ○ 4000°K 		25°/38°/60°	
OFFICE ●		IP40	36W	CRI>80	<ul style="list-style-type: none"> ○ 4000°K 		115°	
PALMA		IP65	4,7W 10,6W 10,1W-11,8W 15,6W	CRI>90 CRI>97 CRI>95	<ul style="list-style-type: none"> ● 2700°K ○ 3000°K ○ 4000°K ● TW 2700-6500°K ● DIM to WARM 2000-3000°K 		UGR<19 L.C REG. PUSH/I-10V DALI CASAMBI	

Familia Family	Installation	IP	Potencia Power	CRI	CCT	Highlights	Acabados Finishes
QUO SMALL	 96	IP20	7,2W 13,2W	CRI>90	<ul style="list-style-type: none"> ● 2700°K ● 3000°K ○ 4000°K 	20°/40°/55° LC REG. PUSH / 1-10V DALI CASAMBI	
QUO LARGE	 98	IP20	17W 18,6W 29,7W	CRI>90 CRI>82 CRI>88 CRI>96 CRI>95 CRI>92	<ul style="list-style-type: none"> ● 2700°K ● 3000°K ○ 4000°K ● 2000°K ● 2500°K ○ 3000°K ○ 3250°K ○ 4000°K 	20°/40°/55° UGR<19 LC REG. PUSH / 1-10V DALI CASAMBI	
QUO JUMBO	 100	IP20	33,8W	CRI>90 CRI>95	<ul style="list-style-type: none"> ● 2700°K ● 3000°K ○ 4000°K ○ 3250°K 	20°/40°/55° UGR<19 LC REG. PUSH / 1-10V DALI CASAMBI	
SCOP	 92	IP20	7,2W 13,2W 18,6W 17W 29,7W	CRI>90 CRI>82 CRI>88 CRI>96 CRI>95 CRI>92	<ul style="list-style-type: none"> ● 2700°K ● 3000°K ○ 4000°K ● 2000°K ● 2500°K ○ 3000°K ○ 3250°K ○ 4000°K 	20°/40°/55° UGR<19 LC REG. 1-10V DALI CASAMBI	
SIGMA	 150  154	IP20	6W 11W 25W 44W 57W	CRI>90	<ul style="list-style-type: none"> ● 2700°K ● 3000°K ○ 4000°K 	48° UGR<19 DALI CASAMBI	
TURT	 168	IP20	8,8W 18,6W	CRI>90 CRI>95	<ul style="list-style-type: none"> ● 2700°K ● 3000°K ○ 4000°K ○ 3250°K 	20°/40°/55° LC REG. PUSH / 1-10V DALI CASAMBI	
UKU	 158	IP20	6W 9W 	CRI>90	<ul style="list-style-type: none"> ● 2700°K ● 3000°K ○ 4000°K 		
VALGUS	 122	IP54	18W	CRI>80	<ul style="list-style-type: none"> ● 3000°K ○ 4000°K 	115° 	
VIP	 64	IP20	4,7W 10,6W 10,1W-11,8W 15,6W	CRI>90 CRI>97 CRI>95	<ul style="list-style-type: none"> ● 2700°K ● 3000°K ○ 4000°K ● TW 2700-6500°K ● DIM to WARM 2000-3000°K 	UGR<19 LC REG. 1-10V DALI CASAMBI	
WINDOW 2	 268	IP44	3W	-	○ 3000°K		

Options: G53 / GU10 / GU5.3 / LED MODUL

Familia Family	Installation	IP	Potencia Power		Materials	Highlights	Acabados Finishes
ATOLON ●	246	IP20	75W / 15W max.	G53/GU10	ACER ALU	90°	White, Black, Grey
CARPO ●	254	IP65	50W max.	GU10 / GU5.3	ALU ALU		White
HAITI ●	276 277	IP20	75W max.	G53 / GU10	C LC	90° 355°	White, Black, Grey
INEL ●	254	IP65		LED MODUL	ACER ZAMAK		White
KOS ●	255	IP20	50W max.	GU10/GU5.3 120°/140°	ACER ACER	30°	White
LEDA ●	257	IP20	50W max.	GU10/GU5.3	ALU ALU	10°	White, Black, Grey
LEN ●	248	IP20		GU10	PLASTER	TRIMLESS	White
MINI LUNA ●	251	IP20	50W max.	GU10/GU5.3	ALU ALU	45°	White, Black, Grey, Blue
NIX ●	252	IP20	50W max.	GU10/GU5.3	ALU ALU	30°	White, Black, Blue
NOK	244	IP20		LED MODUL	ALU		White, Black, Yellow
PALMA ●	250	IP65	50W max.	GU10/GU5.3	ACER ALU		White, Black, Blue
TEN ●	272	IP20	7,5W	GU10	ALU	90° 355°	White, Black

Guía para referencias configurables Guide to configurable references

Round LED COB	CRI – °K CRI – °K	W+Voltaje W+Voltage	Óptica Light beam	Regulación Dimming	Aro Ring	Embellecedor Baffle
1006A-L	● CRI90 2700°K 38	AC110-240V 06A	18° 1	ON-OFF 0	□ -01	□ Bl. / Wh. -01
	○ CRI90 3000°K 39	AC220-240V 06B	28° 2	PUSH/-10V 1	■ -02	■ Ng. / Blk. -02
	○ CRI90 4000°K 40		38° 3	DALI D		■ Crm./Chrm -32
			48° 5	L.C (trailing and leading edge) F		■ Oro/Gold -47

Ref. **1 0 0 6 A - L** - - - -

Opciones de regulación en iluminación técnica: control, eficiencia y confort visual

Dimming options in technical lighting: control, efficiency and visual comfort

En Novolux Lighting entendemos la regulación de la luz como un elemento clave en el diseño y funcionamiento de cualquier instalación. La posibilidad de ajustar la intensidad y el comportamiento de la iluminación permite mejorar la eficiencia energética, el confort visual y la adaptabilidad de los espacios.

Nuestra prioridad es que cada espacio cuente con la solución de control más adecuada, garantizando eficiencia, confort y fiabilidad en cada instalación.

Por ello, ofrecemos distintas opciones de control que se ajustan a las necesidades de cualquier proyecto.

At Novolux Lighting, we view light control as a key element in the design and functionality of any lighting installation. The ability to adjust light intensity and behaviour enhances energy efficiency, visual comfort, and the adaptability of a space.

Our priority is to ensure that every space has the most suitable control solution, guaranteeing efficiency, comfort and reliability in every installation. That's why we offer a range of control options tailored to the needs of any project.



On/Off
El control esencial
Essential control

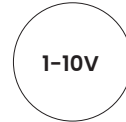

1-10V
Regulación analógica versátil
Versatile analogue dimming

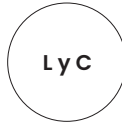

LYC
Control por corte de fase
Phase-cut control

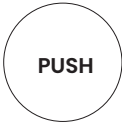

PUSH
Regulación por pulsador
Push-button dimming



CASAMBI
El control inalámbrico inteligente
Smart wireless control



DALI
Control digital y direccionable
Digital and addressable control

On/Off

El control esencial

El sistema On/Off es el punto de partida en cualquier instalación. Su funcionamiento es sencillo: la luminaria se enciende o apaga mediante un interruptor convencional. A pesar de su simplicidad, sigue siendo una solución útil en zonas de paso, espacios técnicos o puntos donde no se requiere atenuación de la luz. Destaca por su bajo coste y facilidad de instalación, aunque no permite modular el flujo luminoso ni integrar funciones avanzadas de gestión.

L y C

Control por corte de fase

Los sistemas L (Leading Edge) y C (Trailing Edge), conocidos como corte de fase, permiten regular la intensidad mediante la modulación de la tensión que llega al driver.

- L (Leading Edge) se utiliza con cargas inductivas, como transformadores electromagnéticos o drivers específicos.
- C (Trailing Edge) es la opción más habitual en drivers LED capacitivos, más estables y silenciosos.

Es importante verificar la compatibilidad entre regulador y driver, ya que no todos los equipos admiten ambos tipos de corte. Este sistema ofrece una regulación eficaz con una instalación sencilla, ideal para proyectos residenciales o de pequeña escala.

On/Off

Essential control

The On/Off system is the starting point for any installation. Its operation is simple: the luminaire is switched on or off via a conventional switch. Despite its simplicity, it remains a useful solution for passageways, technical areas, or locations where dimming is not required. It stands out for its low cost and ease of installation, although it does not allow light output to be modulated or advanced control features to be integrated.

L & C

Phase-cut control

L (Leading Edge) and C (Trailing Edge) systems – commonly referred to as phase-cut dimming – allow intensity to be adjusted by modulating the voltage supplied to the driver.

- L (Leading Edge) is used with inductive loads such as electromagnetic transformers or specific drivers.
- C (Trailing Edge) is the most common option for capacitive LED drivers, offering greater stability and silent operation.

It's important to ensure compatibility between the dimmer and the driver, as not all equipment supports both types of phase-cut. This system provides effective dimming with simple installation, ideal for residential or small-scale projects.

1-10V

Regulación analógica versátil

El sistema 1-10V utiliza una señal analógica continua que varía entre 1 V y 10 V, ajustando de forma progresiva la intensidad de la luz. Es una solución estable y ampliamente utilizada en oficinas, comercios y espacios educativos.

PUSH

Regulación por pulsador

La regulación PUSH (Push Dim) se realiza mediante un pulsador estándar: una pulsación corta enciende o apaga la luminaria, mientras que una pulsación prolongada regula el nivel de luz. Su instalación es sencilla y fiable, con un coste razonable, aunque no permite comunicación bidireccional ni control individualizado de luminarias.

DALI

Control digital y direccionable

DALI (Digital Addressable Lighting Interface) es el estándar internacional de referencia en control digital de iluminación. Permite direccionar cada luminaria de forma independiente, crear grupos o escenas y programar comportamientos personalizados. Entre sus ventajas destacan:

- Comunicación bidireccional, que facilita el monitoreo del estado de cada luminaria.
- Integración con sistemas de gestión de edificios (BMS).
- Alta precisión y estabilidad de regulación.

Es la opción más completa para proyectos profesionales que requieren control centralizado y flexibilidad, como oficinas, hoteles, hospitales o espacios museísticos.

1-10V

Versatile analogue dimming

The 1-10V system uses a continuous analogue signal that varies between 1V and 10V to progressively adjust light intensity. It is a stable and widely used solution in offices, retail environments and educational settings.

PUSH

Push-button dimming

The PUSH (Push Dim) system operates through a standard push button: a short press switches the luminaire on or off, while a long press adjusts the light level. Installation is simple and reliable with a reasonable cost, although this system does not support bidirectional communication or individual luminaire control.

DALI

Digital and addressable control

DALI (Digital Addressable Lighting Interface) is the international standard for digital lighting control. It enables each luminaire to be addressed individually, grouped, or included in programmed scenes with customised behaviours. Key advantages include:

- Bidirectional communication, allowing real-time monitoring of each luminaire's status
- Integration with Building Management Systems (BMS)
- High precision and stable dimming performance

DALI is the most complete solution for professional projects requiring centralised control and flexibility, such as offices, hotels, hospitals, or museums.

CASAMBI

El control inalámbrico inteligente

Casambi ofrece una regulación inalámbrica mediante Bluetooth Low Energy (BLE), sin necesidad de cableado de control adicional. Su configuración a través de una aplicación móvil permite controlar luminarias, programar escenas, integrar sensores o gestionar grupos de forma intuitiva. Entre sus ventajas principales:

- Instalación sencilla, ideal en proyectos de reforma o actualización de instalaciones existentes.
- Configuración desde smartphone o tablet.
- Compatibilidad con drivers y módulos de múltiples fabricantes.
- Integración posible con sistemas DALI o KNX mediante pasarelas.

Casambi representa la evolución hacia la iluminación conectada y flexible, ofreciendo al usuario un control total de su entorno lumínico.

CASAMBI

Smart wireless control

Casambi offers wireless control via Bluetooth Low Energy (BLE), without the need for additional control wiring. Its configuration through a mobile app allows intuitive management of luminaires, scenes, sensors and groups. Key advantages include:

- Easy installation, ideal for refurbishment projects or upgrading existing systems
- Configuration via smartphone or tablet
- Compatibility with drivers and modules from multiple manufacturers
- Possible integration with DALI or KNX systems via gateways

Casambi represents the evolution towards connected, flexible lighting, giving users total control over their lighting environment.



Soluciones modulares con un mismo ADN tecnológico

Modular solutions with a shared technological DNA

Dentro de la gama Indeluz, proponemos cuatro colecciones modulares que comparten la misma base tecnológica, pero que se diferencian en forma y aplicación para responder a distintos requisitos del espacio.

Las familias Scop y Quo, en la categoría de downlights, y Turt y Arrow, en la categoría de proyectores, ofrecen soluciones técnicas versátiles, coherentes entre sí y especialmente adecuadas para proyectos de retail, donde la flexibilidad y la uniformidad estética son clave.

Within the Indeluz range, we present four modular collections that share the same technological foundation but differ in form and application to meet the specific requirements of each space.

The Scop and Quo families, within the downlight category, and Turt and Arrow, within the spotlight category, offer versatile, technically coherent solutions that are particularly well suited to retail projects, where flexibility and aesthetic consistency are key.

SCOP



p. 92

QUO



p. 96

TURT



p. 168

ARROW



p. 170

SCOP & QUO

Potencia_Power	CRI / CCT	Regulación_Dimming
7,2W	● 2700°K ○ 3000°K ○ 4000°K	ON-OFF L, C ((Trailing and leading edge) PUSH / 1-10V DALI CASAMBI
13,2W	CRI>90	
18,6W	● 2000°K	
17W	● 2500°K	
29,7W	● 3000°K	
33,8W*	○ 3250°K ○ 4000°K	

* Solo disponible para modelo Quo Jumbo_Only available for Quo Jumbo model

TURT & ARROW

Potencia_Power	CRI / CCT	Regulación_Dimming
8,8W	● 2700°K ○ 3000°K ○ 4000°K	ON-OFF L, C ((Trailing and leading edge) PUSH / 1-10V DALI CASAMBI
18,6W	CRI>90	
24W*	● 2000°K	
27,4W*	● 2500°K	
	● 3000°K	
	○ 3250°K ○ 4000°K	

* Solo disponible para modelo Arrow large_Only available for Arrow large model

Ópticas_Light beam

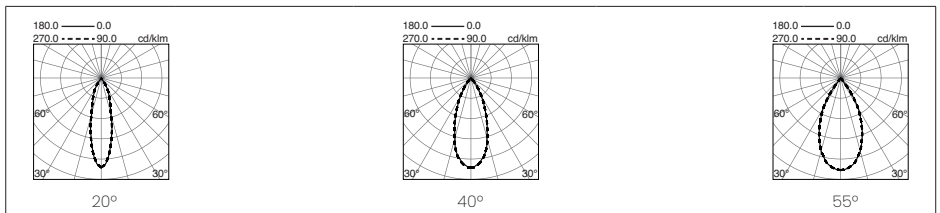

Downlights_

VIP

Vip es una colección de downlights modulares, diseñada para ofrecer un alto rendimiento en un formato compacto y discreto. Disponible en tres versiones –4,7W, 10,1–11,8W y 15,6W–, se adapta a múltiples requerimientos luminicos en cualquier espacio interior.

Toda la gama está disponible en temperaturas de color de 2700K, 3000K y 4000K, tanto en versiones CRI90 como CRI97 (espectro similar al solar), e incluye una versión dim to warm (CRI95) que ajusta la temperatura de color entre 2000K y 3000K, ideal para crear ambientes cálidos y dinámicos. Incorpora ópticas intercambiables con cuatro ángulos de apertura: 18°, 28°, 38° y 50°, lo que permite ajustar el haz de luz según la funcionalidad y la estética del espacio. El módulo orientable hasta 30° añade flexibilidad en la dirección de la luz, ideal para acentos o iluminación direccional.

Vip ofrece cinco opciones de regulación: on-off, Leading Edge/Trailing Edge (LC), PUSH/1-10V, DALI y Casambi, lo que facilita su integración en sistemas de control convencionales o inteligentes.

Con cuerpo de aluminio y acabados en blanco o negro, se completa con embellecedores en blanco, negro, cromo u oro, permitiendo una personalización estética en función del lenguaje del proyecto.

Vip is a collection of modular downlights designed to deliver high performance in a compact and discreet format. Available in three versions – 4.7W, 10.1–11.8W and 15.6W – it adapts to a wide range of lighting requirements in any interior space.

The full range is available in 2700K, 3000K and 4000K colour temperatures, with options in both CRI90 and CRI97 (sunlight-like spectrum), and includes a dim-to-warm version (CRI95) that adjusts the colour temperature between 2000K and 3000K – ideal for creating warm, dynamic atmospheres. It features interchangeable optics with four beam angles: 18°, 28°, 38° and 50°, allowing the light beam to be tailored to the functionality and aesthetics of the space. The module is tiltable up to 30°, providing additional flexibility in directing the light – perfect for accent or directional lighting.

Vip offers five dimming options: on-off, Leading Edge/Trailing Edge (LC), PUSH/1-10V, DALI and Casambi, making it easy to integrate into both conventional and smart control systems.

With an aluminium body available in white or black, it is complemented by trim rings in white, black, chrome or gold – allowing for aesthetic customisation in line with the project's design language.

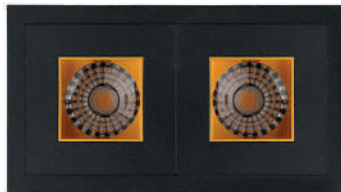

Potencia_Power	CRI / CCT	Regulación_Dimming
4,7W 10,1W - 11,8W 15,6W	<ul style="list-style-type: none"> ● 2700°K ○ 3000°K ○ 4000°K 	ON-OFF L,C PHASE CUT PUSH 1-10V DALI CASAMBI
	<ul style="list-style-type: none"> ● DTW 2000°K-3000°K ● TUNABLE WHITE 2700°K -6500°K 	

Ópticas_Light beam

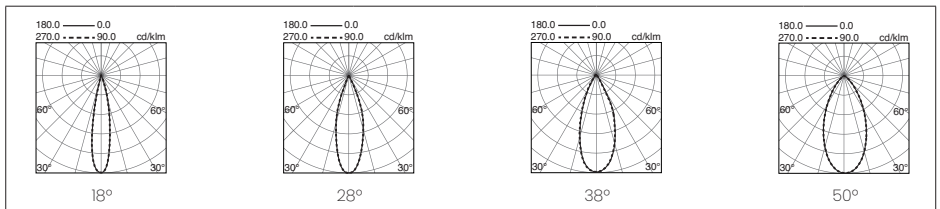

VIP 1



Acabado blanco o negro con embellecedor blanco, negro, cromado u oro
White or black finish with white, black, chrome or gold baffle

Con Driver remoto
With Remote Driver



Acabados_Finishes



-01-01



-01-02



-01-32



-01-47



-02-01



-02-02



-02-32



-02-47

Accesorios – Accessories



Antideslumbrante
Anti-glare

■ A04Q-1006-02



Oval



A47Q-1006-92



IP 44



A47R-1006-92

VIP 1

4,7W

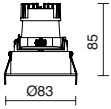

CRI90

2700°K **650lm**

3000°K **680lm**

4000°K **719lm**

Round LED COB	CRI – °K CRI – °K	Voltaje Voltage	Óptica Light beam	Regulación Dimming	Aro Ring	Embellecedor Baffle
1006A-L	● CRI90 2700°K 38	AC110-240V 06A	18° 1	ON-OFF 0	□ -01	□ Bl. / Wh. -01
	● CRI90 3000°K 39	AC220-240V 06B	28° 2	PUSH/1-10V 1	■ -02	■ Ng. / Blk. -02
	○ CRI90 4000°K 40		38° 3	DALI D		■ Crm./Chrm -32
			48° 5	L,C (trailing and leading edge) F		■ Oro/Gold -47

Ref. **1 0 0 6 A - L** - - - - -

Regulaciones disponibles según voltaje_Dimming options according to voltage

AC110-240V	ON-OFF	AC220-240V	ON-OFF
	PUSH/1-10V		L,C (trailing and leading edge)
	DALI		

VIP 1

10,1W - 11,8W

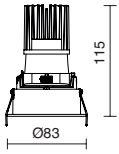

10,6W	10,1W	11,8W	10,6W
CRI90	CRI97	CRI95 (DTW)	TUNABLE WHITE
2700°K 1317lm	2700°K 923lm	2000°K 28lm	2700°K 1278lm
3000°K 1376lm	3000°K 949lm	3000°K 1179lm	6500°K 1563lm
4000°K 1456lm	4000°K 1031lm		

Round LED COB	CRI – °K	Voltage	Óptica	Regulación	Aro	Embellecedor
LED COB	CRI – °K	Voltage	Light beam	Dimming	Ring	Baffle
1006A-L	● CRI90 2700°K 38	AC110-240V 13A	18° 1	ON-OFF 0	□ -01	□ Bl. / Wh. -01
	○ CRI90 3000°K 39	AC220-240V 13B	28° 2	L,C (trailing and leading edge) F	■ -02	■ Ng. / Blk. -02
	○ CRI90 4000°K 40		38° 3	PUSH/I-10V 1		■ Crm./Chrm -32
	● CRI97 2700°K 53		48° 5	DALI D		■ Oro/Gold -47
	○ CRI97 3000°K 54			CASAMBI M		
	○ CRI97 4000°K 55					
	○ TUNABLE WHITE 2700°K-6500°K 56					
	● CRI95 DIM TO WARM 2000°K-3000°K 57					

Ref. 1 0 0 6 A - L

Regulaciones disponibles según voltaje... Dimming options according to voltage

CRI90 2700K-3000K-4000K	CRI97 2700K-3000K-4000K	CRI95 (DTW) 2000K-3000K
AC110-240V PUSH/I-10V DALI	AC110-240V PUSH/I-10V DALI	AC110-240V PUSH/I-10V
AC220-240V ON-OFF L,C (trailing and leading edge) CASAMBI	AC220-240V ON-OFF L,C (trailing and leading edge) CASAMBI	AC220-240V DALI CASAMBI
TUNABLE WHITE 2700K-6500K		
AC220-240V DALI		

VIP 1

15,6W

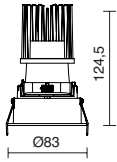

CRI90	
2700°K	1940lm
3000°K	2028lm
4000°K	2145lm

Round LED COB	CRI – °K		Voltaje Voltage	Óptica Light beam	Regulación Dimming	Aro Ring	Embellecedor Baffle
1006A-L	● CRI90 2700°K	38	AC220-240V	18°	1	ON-OFF 0	□ Bl. / Wh. -01
	○ CRI90 3000°K	39		28°	2	L/C (Trailing and leading edge) F	■ Ng. / Blk. -02
	○ CRI90 4000°K	40		38°	3	PUSH/I-10V 1	■ Crm./Chrm -32
				48°	5	DALI D	■ Oro/Gold -47
						CASAMBI M	

Ref. 1 0 0 6 A - L 1 8 B - - - -

Regulaciones disponibles según voltaje_Dimming options according to voltage

AC220-240V	ON-OFF
	L/C (Trailing and leading edge)
	PUSH/I-10V
	DALI
	CASAMBI



VIP 1T



Acabado blanco o negro con embellecedor blanco, negro, cromado u oro
White or black finish with white, black, chrome or gold baffle

Con Driver remoto
With Remote Driver

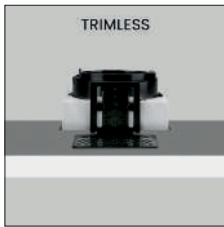

Acabados_Finishes



Accesorios – Accessories



■ A04Q-1006-02



A47Q-1006-92



A47R-1006-92

VIP 1T

4,7W

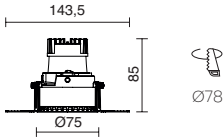

CRI90

2700°K **650lm**

3000°K **680lm**

4000°K **719lm**

Round
LED COB

CRI – °K
CRI – °K

Voltaje
Voltage

Óptica
Light beam

Regulación
Dimming

Aro
Ring

Embellecedor
Baffle

1009A-L

● CRI90 2700°K **38**
● CRI90 3000°K **39**
○ CRI90 4000°K **40**

AC110-240V **06A**
AC220-240V **06B**

18° **1**
28° **2**
38° **3**
48° **5**

ON-OFF **0**
PUSH/1-10V **1**
DALI **D**
LC (trailing and leading edge) **F**

□ **-01**

□ Bl. / Wh. **-01**
■ Ng. / Blk. **-02**
■ Crm./Chrm **-32**
■ Oro/Gold **-47**

Ref. **1 0 0 9 A - L** - - - - -

Regulaciones disponibles según voltaje_Dimming options according to voltage

AC110-240V

ON-OFF

PUSH/1-10V

DALI

AC220-240V

ON-OFF

LC (trailing and leading edge)

VIP 1T

10,1W – 11,8W

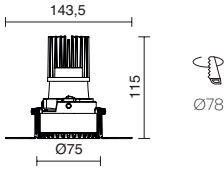

10,6W	10,1W	11,8W	10,6W
CRI90	CRI97	CRI95	TUNABLE WHITE
2700°K 1317lm	2700°K 923lm	2000°K 28lm	2700°K 1278lm
3000°K 1376lm	3000°K 949lm	3000°K 1179lm	6500°K 1563lm
4000°K 1456lm	4000°K 1031lm		

Round LED COB	CRI – °K	Voltage	Óptica	Regulación	Aro	Embellecedor
LED COB	CRI – °K	Voltage	light beam	Dimming	Ring	Baffle
1009A-L	● CRI90 2700°K 38	AC110-240V 13A	18° 1	ON-OFF 0	□ -01	□ Bl. / Wh. -01
	○ CRI90 3000°K 39	AC220-240V 13B	28° 2	L,C (trailing and leading edge) F		■ Ng. / Blk. -02
	○ CRI90 4000°K 40		38° 3	PUSH/I-10V 1		■ Crm./Chrm -32
	● CRI97 2700°K 53		48° 5	DALI D		■ Oro/Gold -47
	○ CRI97 3000°K 54			CASAMBI M		
	○ CRI97 4000°K 55					
	● TUNABLE WHITE 2700°K - 6500°K 56					
	● CRI95 DIM TO WARM 2000°K-3000°K 57					

Ref. **1 0 0 9 A - L**

Regulaciones disponibles según voltaje...Dimming options according to voltage

CRI90 2700K-3000K-4000K	CRI97 2700K-3000K-4000K	CRI95 (DTW) 2000K-3000K
AC110-240V <u>PUSH/I-10V</u> <u>DALI</u>	AC110-240V <u>PUSH/I-10V</u> <u>DALI</u>	AC110-240V <u>PUSH/I-10V</u>
AC220-240V <u>ON-OFF</u> <u>L,C (trailing and leading edge)</u> <u>CASAMBI</u>	AC220-240V <u>ON-OFF</u> <u>L,C (trailing and leading edge)</u> <u>CASAMBI</u>	AC220-240V <u>DALI</u> <u>CASAMBI</u>
TUNABLE WHITE 2700K-6500K		
AC220-240V <u>DALI</u>		

Otras potencias disponibles...Other available powers

15,6W	
CRI90	
2700°K 1940lm	
3000°K 2028lm	
4000°K 2145lm	



VIP 2



Acabado blanco o negro con embellecedor blanco, negro, cromado u oro
White or black finish with white, black, chrome or gold baffle

Con Driver remoto
With Remote Driver

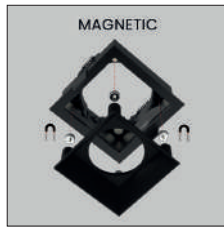

Acabados_Finishes



-01-01

-01-02

-01-32

-01-47

-02-01

-02-02

-02-32

-02-47

Accesorios – Accessories



Antideslumbrante
Anti-glare

■ A04Q-1006-02



Oval

A47Q-1006-92



A47T-1006-92

VIP 2

10,1W – 11,8W

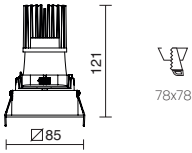

10,6W		10,1W		11,8W		10,6W	
CRI90		CRI97		CRI95		TUNABLE WHITE	
2700°K	1317lm	2700°K	923lm	2000°K	281lm	2700°K	1278lm
3000°K	1376lm	3000°K	949lm	3000°K	1179lm	6500°K	1563lm
4000°K	1456lm	4000°K	1031lm				

Square

Round

LED COB

CRI – °K

CRI – °K

Voltaje

Voltage

Óptica

Light beam

Regulación

Dimming

Aro

Ring

Embellecedor

Baffle

1007A-L

● CRI90 2700°K **38**

● CRI90 3000°K **39**

○ CRI90 4000°K **40**

● CRI97 2700°K **53**

● CRI97 3000°K **54**

○ CRI97 4000°K **55**

● TUNABLE WHITE
2700°K – 6500°K **56**

● CRI95 DIM TO WARM
2000°K-3000°K **57**

AC110-240V **13A**

AC220-240V **13B**

18° **1**

28° **2**

38° **3**

48° **5**

ON-OFF **0**

L,C (trailing and leading edge) **F**

PUSH/I-10V **1**

DALI **D**

CASAMBI **M**

□ **-01**

■ **-02**

□ Bl. / Wh. **-01**

■ Ng. / Blk. **-02**

■ Crm./Chrm **-32**

■ Oro/Gold **-47**

Ref. **1 0 0 7 A - L**

Regulaciones disponibles según voltaje...Dimming options according to voltage

CRI90 2700K-3000K-4000K

AC110-240V

PUSH/I-10V

DALI

AC220-240V

ON-OFF

L,C (trailing and leading edge)

CASAMBI

CRI97 2700K-3000K-4000K

AC110-240V

PUSH/I-10V

DALI

AC220-240V

ON-OFF

L,C (trailing and leading edge)

CASAMBI

CRI95 (DTW) 2000K-3000K

AC110-240V

PUSH/I-10V

AC220-240V

DALI

CASAMBI

TUNABLE WHITE 2700K-6500K

AC220-240V

DALI

Otras potencias disponibles...Other available powers

4,7W

CRI90

2700°K **650lm**

3000°K **680lm**

4000°K **719lm**

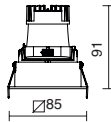

15,6W

CRI90

2700°K **1940lm**

3000°K **2028lm**

4000°K **2145lm**

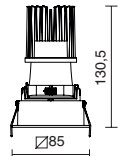

VIP 2



Acabado blanco o negro con embellecedor blanco, negro, cromado u oro
White or black finish with white, black, chrome or gold baffle

Con Driver remoto
With Remote Driver

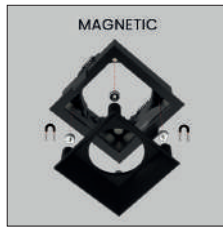

Acabados_Finishes



-01-01

-01-02

-01-32

-01-47

-02-01

-02-02

-02-32

-02-47

Accesorios – Accessories



Antideslumbrante
Anti-glare

■ A04Q-1006-02



Oval



A47Q-1006-92



A47T-1006-92

VIP 2

4,7W x2

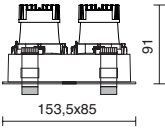

CRI90	
2700°K	650lm
3000°K	680lm
4000°K	719lm

2x Square
Round
LED COB

CRI – °K
CRI – °K

Voltaje
Voltage

Óptica
Light beam

Regulación
Dimming

Aro
Ring

Embellededor
Baffle

1007B-L	○ CRI90 2700°K 38 ○ CRI90 3000°K 39 ○ CRI90 4000°K 40	AC110-240V 06A AC220-240V 06B	18° 1 28° 2 38° 3 48° 5	ON-OFF 0 PUSH/1-10V 1 DALI D LC (trailing and leading edge) F	□ -01 ■ -02	□ Bl. / Wh. -01 ■ Ng. / Blk. -02 ▣ Crm./Chrm -32 ▤ Oro/Gold -47
----------------	--	--	--	--	------------------------------	--

Ref. 1 0 0 7 B - L [] [] [] [] [] [] [] [] [] [] - [] [] [] [] [] []

Regulaciones disponibles según voltaje – Dimming options according to voltage

AC110-240V	ON-OFF PUSH/1-10V DALI	AC220-240V	ON-OFF LC (trailing and leading edge)
-------------------	------------------------------	-------------------	--

VIP 2

15,6W x2

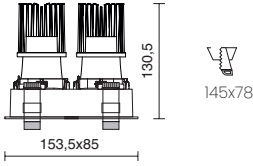

CRI90

2700°K	1940lm
3000°K	2028lm
4000°K	2145lm

2x Square

Round

LED COB

CRI – °K

CRI – °K

1007B-L

● CRI90 2700°K **38**

○ CRI90 3000°K **39**

○ CRI90 4000°K **40**

Voltaje

Voltage

AC220-240V 18B

Óptica

Light beam

18° **1**

28° **2**

38° **3**

48° **5**

Regulación

Dimming

ON-OFF **0**

L/C (trailing and leading edge) **F**

PUSH/1-10V **1**

DALI **D**

CASAMBI **M**

Aro

Ring

□ **-01**

■ **-02**

Embellecedor

Baffle

□ Bl. / Wh. **-01**

■ Ng. / Blk. **-02**

■ Crm./Chrm **-32**

■ Oro/Gold **-47**

Ref. **1 0 0 7 B - L 1 8 B - - - -**

Regulaciones disponibles según voltaje...Dimming options according to voltage

AC220-240V

ON-OFF

L/C (Trailing and leading edge)

PUSH/1-10V

DALI

CASAMBI

Otras potencias disponibles...Other available powers

10,6W	10,1W	11,8W	10,6W	
CRI90	CRI97	CRI95	TUNABLE WHITE	
2700°K 1317lm	2700°K 923lm	2000°K 28lm	2700°K 1278lm	
3000°K 1376lm	3000°K 949lm	3000°K 1179lm	6500°K 1563lm	
4000°K 1456lm	4000°K 1031lm			

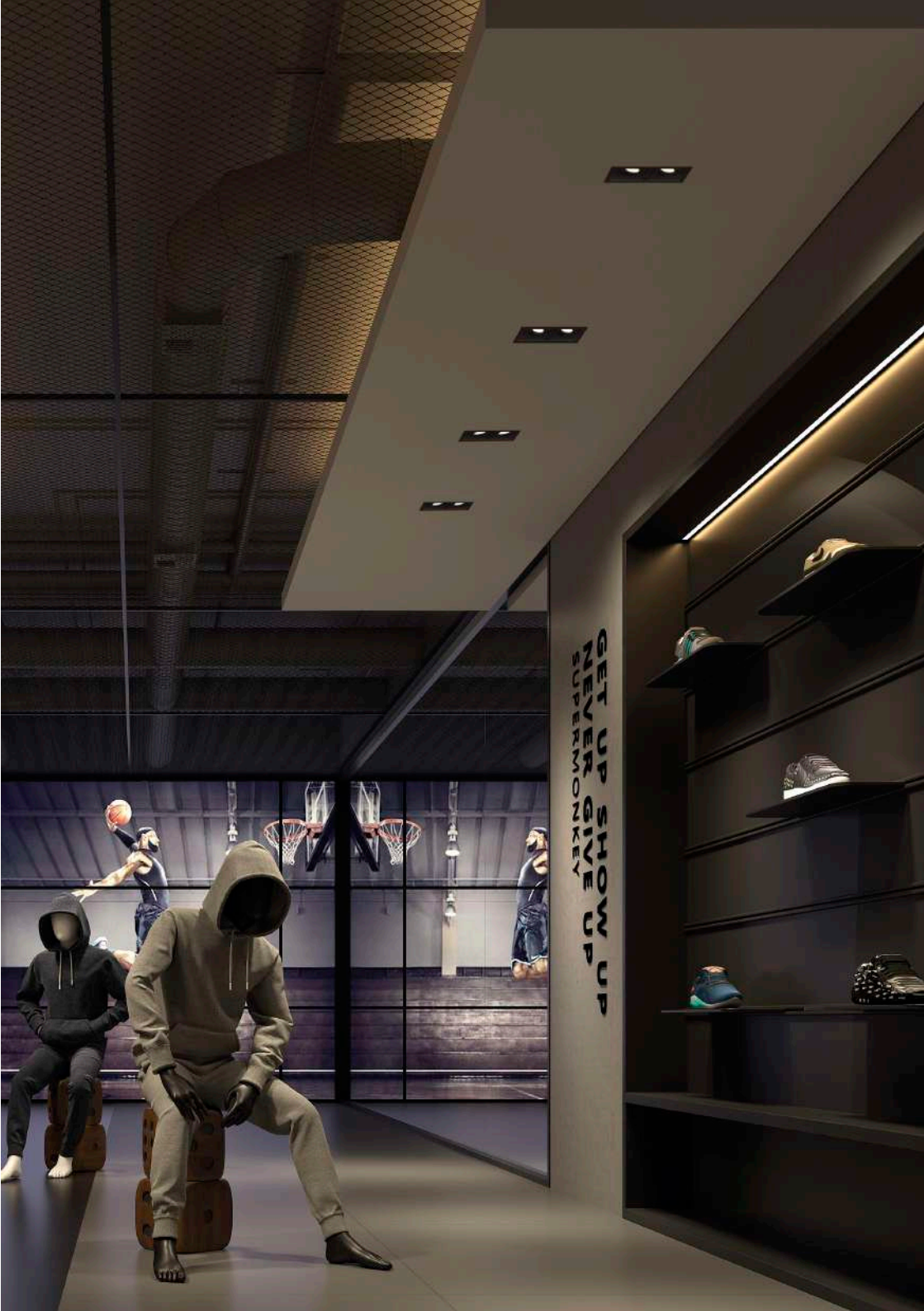

GET UP SHOW UP
NEVER GIVE UP
SUPERMAN KEY

VIP 2T

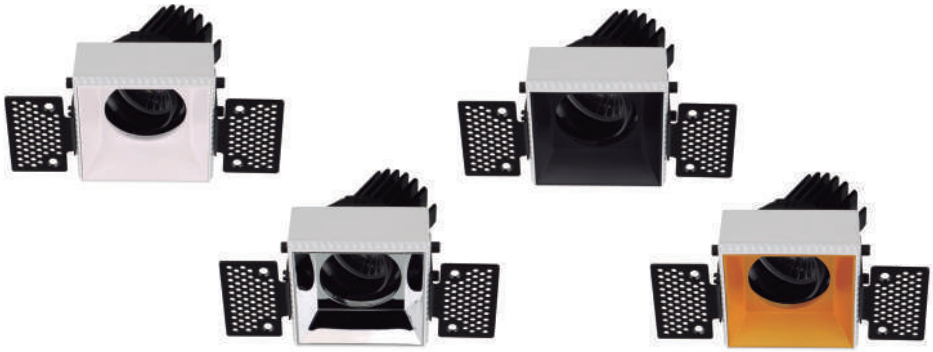

Acabado blanco con embellecedor blanco, negro, cromado u oro
White finish with white, black, chrome or gold baffle

Con Driver remoto
With Remote Driver

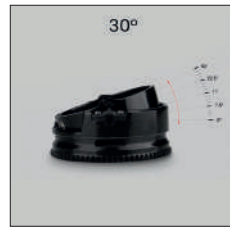
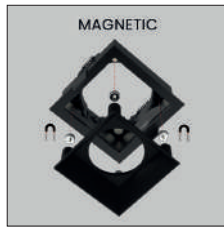
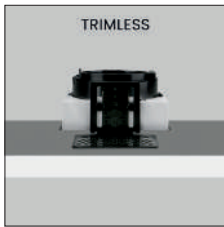

Acabados_Finishes



-01-01



-01-02



-01-32



-01-47

Accesorios – Accessories



Antideslumbrante
Anti-glare

■ A04Q-1006-02



Oval



A47Q-1006-92



A47T-1006-92

VIP 2T

10,1W – 11,8W

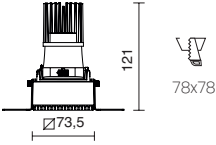

10,6W	10,1W	11,8W	10,6W
CRI90	CRI97	CRI95	TUNABLE WHITE
2700°K 1317lm	2700°K 923lm	2000°K 281lm	2700°K 1278lm
3000°K 1376lm	3000°K 949lm	3000°K 1179lm	6500°K 1563lm
4000°K 1456lm	4000°K 1031lm		

Square

Round

LED COB

CRI – °K

CRI – °K

Voltaje

Voltage

Óptica

Light beam

Regulación

Dimming

Aro

Ring

Embellecedor

Baffle

1010A-L

● CRI90 2700°K **38**

○ CRI90 3000°K **39**

○ CRI90 4000°K **40**

● CRI97 2700°K **53**

○ CRI97 3000°K **54**

○ CRI97 4000°K **55**

● TUNABLE WHITE
2700°K – 6500°K **56**

● CRI95 DIM TO WARM
2000°K-3000°K **57**

AC110-240V **13A**

AC220-240V **13B**

18° **1**

28° **2**

38° **3**

48° **5**

ON-OFF **0**

L,C (trailing and leading edge) **F**

PUSH/1-10V **1**

DALI **D**

CASAMBI **M**

□ **-01**

□ Bl. / Wh. **-01**

■ Ng. / Blk. **-02**

■ Crm./Chrm **-32**

■ Oro/Gold **-47**

Ref. **1 0 1 0 A - L**

Regulaciones disponibles según voltaje...Dimming options according to voltage

CRI90 2700K-3000K-4000K

AC110-240V

PUSH/1-10V

DALI

AC220-240V

ON-OFF

L,C (trailing and leading edge)

CASAMBI

CRI97 2700K-3000K-4000K

AC110-240V

PUSH/1-10V

DALI

AC220-240V

ON-OFF

L,C (trailing and leading edge)

CASAMBI

CRI95 (DTW) 2000K-3000K

AC110-240V

PUSH/1-10V

AC220-240V

DALI

CASAMBI

TUNABLE WHITE 2700K-6500K

AC220-240V

DALI

Otras potencias disponibles...Other available powers

4,7W

CRI90

2700°K **650lm**

3000°K **680lm**

4000°K **719lm**

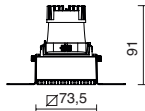

15,6W

CRI90

2700°K **1940lm**

3000°K **2028lm**

4000°K **2145lm**

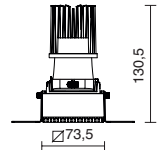

VIP 3

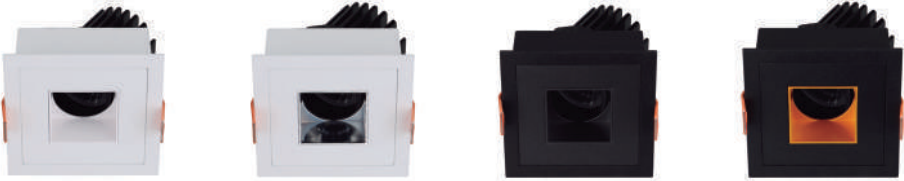

Acabado blanco o negro con embellecedor blanco, negro, cromado u oro
White or black finish with white, black, chrome or gold baffle

Con Driver remoto
With Remote Driver

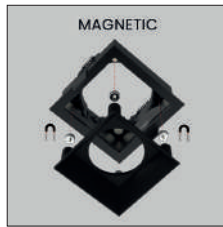

Acabados_Finishes



-01-01



-01-02



-01-32



-01-47



-02-01



-02-02



-02-32



-02-47

Accesorios – Accessories



Antideslumbrante
Anti-glare

■ A04Q-1006-02



Oval



A47Q-1006-92

VIP 3

10,1W – 11,8W

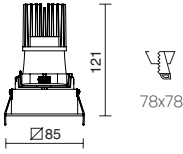

10,6W	10,1W	11,8W	10,6W
CRI90	CRI97	CRI95	TUNABLE WHITE
2700°K 1317lm	2700°K 923lm	2000°K 281lm	2700°K 1278lm
3000°K 1376lm	3000°K 949lm	3000°K 1179lm	6500°K 1563lm
4000°K 1456lm	4000°K 1031lm		

Square

Square

LED COB

CRI – °K

CRI – °K

Voltaje

Voltage

Óptica

Light beam

Regulación

Dimming

Aro

Ring

Embellecedor

Baffle

1008A-L

● CRI90 2700°K **38**

● CRI90 3000°K **39**

○ CRI90 4000°K **40**

● CRI97 2700°K **53**

● CRI97 3000°K **54**

○ CRI97 4000°K **55**

● TUNABLE WHITE
2700°K – 6500°K **56**

● CRI95 DIM TO WARM
2000°K-3000°K **57**

AC110-240V **13A**

AC220-240V **13B**

18° **1**

28° **2**

38° **3**

48° **5**

ON-OFF **0**

L,C (trailing and leading edge) **F**

PUSH/1-10V **1**

DALI **D**

CASAMBI **M**

□ **-01**

■ **-02**

□ Bl. / Wh. **-01**

■ Ng. / Blk. **-02**

■ Crm./Chrm **-32**

■ Oro/Gold **-47**

Ref. **1 0 0 8 A - L**

Regulaciones disponibles según voltaje...Dimming options according to voltage

CRI90 2700K-3000K-4000K

AC110-240V

PUSH/1-10V

DALI

AC220-240V

ON-OFF

L,C (trailing and leading edge)

CASAMBI

CRI97 2700K-3000K-4000K

AC110-240V

PUSH/1-10V

DALI

AC220-240V

ON-OFF

L,C (trailing and leading edge)

CASAMBI

CRI95 (DTW) 2000K-3000K

AC110-240V

PUSH/1-10V

AC220-240V

DALI

CASAMBI

TUNABLE WHITE 2700K-6500K

AC220-240V

DALI

Otras potencias disponibles...Other available powers

4,7W

CRI90

2700°K **650lm**

3000°K **680lm**

4000°K **719lm**

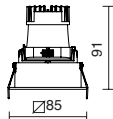

15,6W

CRI90

2700°K **1940lm**

3000°K **2028lm**

4000°K **2145lm**

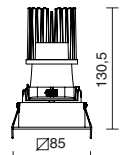

VIP 3



Acabado blanco o negro con embellecedor blanco, negro, cromado u oro
White or black finish with white, black, chrome or gold baffle

Con Driver remoto
With Remote Driver

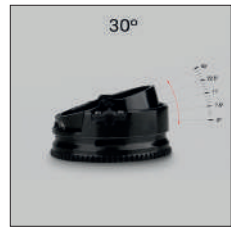
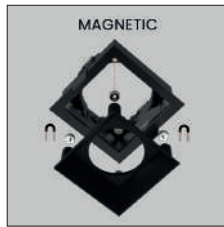

Acabados_Finishes



Accesorios – Accessories



■ A04Q-1006-02



A47Q-1006-92

VIP 3

10,1W – 11,8W

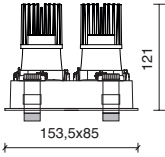

10,6W		10,1W		11,8W		10,6W	
CRI90		CRI97		CRI95		TUNABLE WHITE	
2700°K	1317lm	2700°K	923lm	2000°K	28lm	2700°K	1278lm
3000°K	1376lm	3000°K	949lm	3000°K	1179lm	6500°K	1563lm
4000°K	1456lm	4000°K	1031lm				

2x Square Square

LED COB

CRI – °K

CRI – °K

Voltaje

Voltage

Óptica

Light beam

Regulación

Dimming

Aro

Ring

Embelecedor

Baffle

1008B-L

● CRI90 2700°K 38

○ CRI90 3000°K 39

○ CRI90 4000°K 40

● CRI97 2700°K 53

○ CRI97 3000°K 54

○ CRI97 4000°K 55

○ TUNABLE WHITE

2700°K – 6500°K 56

● CRI95 DIM TO WARM

2000°K-3000°K 57

AC110-240V 13A

AC220-240V 13B

18° 1

28° 2

38° 3

48° 5

ON-OFF 0

L,C (trailing and leading edge) F

PUSH/1-10V 1

DALI D

CASAMBI M

□ -01

■ -02

□ Bl. / Wh. -01

■ Ng. / Blk. -02

■ Crm./Chrm -32

■ Oro/Gold -47

Ref. 1 0 0 8 B - L

Regulaciones disponibles según voltaje – Dimming options according to voltage

CRI90 2700K-3000K-4000K

AC110-240V

PUSH/1-10V

DALI

AC220-240V

ON-OFF

L,C (trailing and leading edge)

CASAMBI

CRI97 2700K-3000K-4000K

AC110-240V

PUSH/1-10V

DALI

AC220-240V

ON-OFF

L,C (trailing and leading edge)

CASAMBI

CRI95 (DTW) 2000K-3000K

AC110-240V

PUSH/1-10V

AC220-240V

DALI

CASAMBI

TUNABLE WHITE 2700K-6500K

AC220-240V

DALI

Otras potencias disponibles – Other available powers

4,7W

CRI90

2700°K 650lm

3000°K 680lm

4000°K 719lm

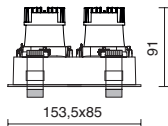

15,6W

CRI90

2700°K 1940lm

3000°K 2028lm

4000°K 2145lm

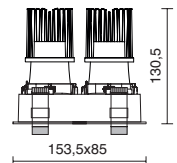

VIP 3T

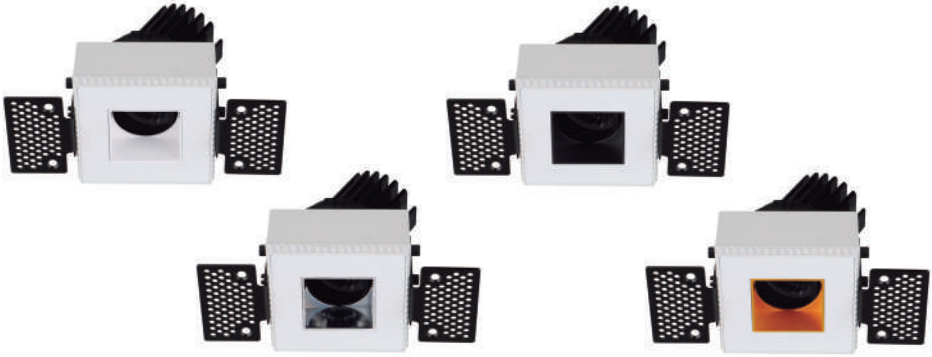

Acabado blanco con embellecedor blanco, negro, cromado u oro
White finish with white, black, chrome or gold baffle

Con Driver remoto
With Remote Driver

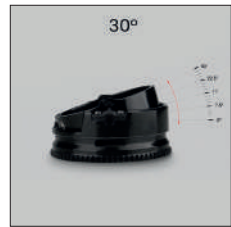
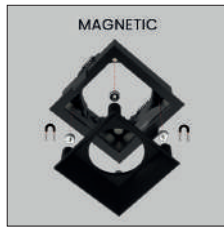
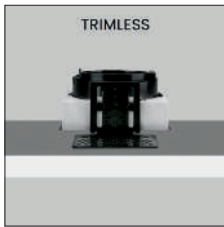

Acabados_Finishes



-01-01



-01-02



-01-32



-01-47

Accesorios – Accessories



Antideslumbrante
Anti-glare

■ A04Q-1006-02



Oval



A47Q-1006-92

VIP 3T

4,7W x2

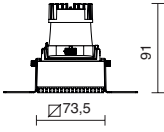

CRI90

2700°K	650lm
3000°K	680lm
4000°K	719lm

Square

Square
LED COB

CRI – °K
CRI – °K

Voltaje
Voltage

Óptica
Light beam

Regulación
Dimming

Aro
Ring

Embelecedor
Baffle

1011A-L

● CRI90 2700°K	38
● CRI90 3000°K	39
○ CRI90 4000°K	40

AC110-240V	06A
AC220-240V	06B

18°	1
28°	2
38°	3
48°	5

ON-OFF	0
PUSH/I-10V	1
DALI	D
L,C (trailing and leading edge)	F

□ **-01**

□ Bl./Wh.	-01
■ Ng./Blk.	-02
■ Crm./Chrm	-32
■ Oro/Gold	-47

Ref. **1 0 1 1 A - L** - - - - -

Regulaciones disponibles según voltaje_Dimming options according to voltage

AC110-240V

ON-OFF
PUSH/I-10V
DALI

AC220-240V

ON-OFF
L,C (trailing and leading edge)

Otras potencias disponibles_Other available powers

10,6W	10,1W	11,8W	10,6W	
<i>CRI90</i>	<i>CRI97</i>	<i>CRI95</i>	<i>TUNABLE WHITE</i>	
2700°K 1317lm	2700°K 923lm	2000°K 28lm	2700°K 1278lm	
3000°K 1376lm	3000°K 949lm	3000°K 1179lm	6500°K 1563lm	
4000°K 1456lm	4000°K 1031lm			

15,6W	
<i>CRI90</i>	
2700°K 1940lm	
3000°K 2028lm	
4000°K 2145lm	

VIP 1 MINI



Acabado blanco o negro con embellecedor blanco, negro, cromado u oro
White or black finish with white, black, chrome or gold baffle

Con Driver remoto
With Remote Driver

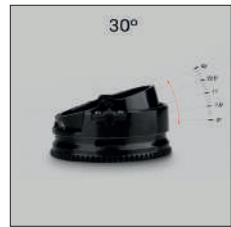

Acabados_Finishes



-01-01

-01-02

-01-32

-01-47

-02-01

-02-02

-02-32

-02-47

Accesorios – Accessories



Antideslumbrante
Anti-glare

■ A04Q-1092-02



Oval



A47Q-1092-92



A47R-1092-92

VIP 1 MINI

4,7W



CRI90

2700°K **650lm**

3000°K **680lm**

4000°K **719lm**

Round
LED COB

CRI – °K
CRI – °K

Voltaje
Voltage

Óptica
Light beam

Regulación
Dimming

Aro
Ring

Embellecedor
Baffle

1092A-L

● CRI90 2700°K **38**

AC110-240V **06A**

18° **1**

ON-OFF **0**

□ **-01**

□ Bl. / Wh. **-01**

● CRI90 3000°K **39**

AC220-240V **06B**

30° **3**

L,C (trailing and leading edge) **F**

■ **-02**

■ Ng. / Blk. **-02**

○ CRI90 4000°K **40**

50° **5**

PUSH/I-10V **1**

■ Crm./Chrm **-32**

DALI **D**

■ Ora/Gold **-47**

Ref. **1 0 9 2 A - L**

Regulaciones disponibles según voltaje_Dimming options according to voltage

AC110-240V

ON-OFF

PUSH/I-10V

DALI

AC220-240V

ON-OFF

L,C (trailing and leading edge)

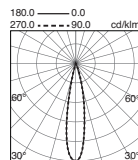

18°

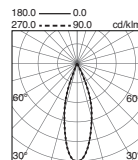

30°

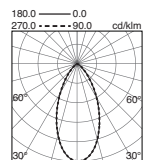

50°

VIP 1 MINI

10,1-11,8W

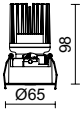

10,6W	10,1W	11,8W
CRI90	CRI97	CRI95 DTW
2700°K 1317lm	2700°K 923lm	2000°K 28lm
3000°K 1376lm	3000°K 949lm	3000°K 1179lm
4000°K 1456lm	4000°K 1031lm	

Square
Round
LED COB

CRI – °K
CRI – °K

Voltage
Voltage

Óptica
light beam

Regulación
Dimming

Aro
Ring

Embellecedor
Baffle

1092A-L

- CRI90 2700°K **38**
- CRI90 3000°K **39**
- CRI90 4000°K **40**
- CRI97 2700°K **53**
- CRI97 3000°K **54**
- CRI97 4000°K **55**
- CRI95 DIM TO WARM 2000°K-3000°K **57**

AC110-240V 13A
AC220-240V 13B

18° 1
30° 3
50° 5

ON-OFF 0
L/C (Trailing and leading edge) F
PUSH/I-10V 1
DAI D
CASAMBI M

□ -01
■ -02

□ Bl. / Wh. -01
■ Ng. / Bk. -02
■ Crm./Chrm -32
■ Oro/Gold -47

Ref. **1 0 9 2 A - L** - -

Regulaciones disponibles según voltaje...Dimming options according to voltage

AC110-240V L40	<u>PUSH/I-10V</u>	AC220-240V	<u>ON-OFF</u>
AC110-240V	<u>PUSH/I-10V</u> <u>DAI</u>	AC220-240V	<u>L/C (Trailing and leading edge) ON-OFF</u> <u>CASAMBI</u> <u>L/C (Trailing and leading edge)</u> <u>DAI</u> <u>CASAMBI</u>
-L53 -L54 -L55			
AC110-240V	<u>PUSH/I-10V</u> <u>DAI</u>	AC220-240V	<u>ON-OFF</u> <u>L/C (Trailing and leading edge)</u> <u>CASAMBI</u>
-L57			
AC110-240V	<u>PUSH/I-10V</u>	AC220-240V	<u>DAI</u> <u>CASAMBI</u>

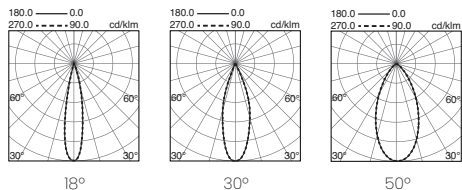

VALERO'S



SCOP

SMALL



Acabado blanco con embellecedor blanco o cromado
White finish with white or chrome baffle

Con Driver remoto
With Remote Driver

Acabados_Finishes



-01-01



-01-32

Accesorios – Accessories



Antideslumbrante
Anti-glare

■ A04P-1002-02



Prismatico
Prismatic

■ A47F-1002-92



SCOP

SMALL

13,2W



CRI90

2700°K **1448lm**

3000°K **1506lm**

4000°K **1613lm**

Round LED COB	CRI – °K CRI – °K	Voltaje Voltage	Óptica Light beam	Regulación Dimming	Aro Ring	Embellecedor Baffle
1004A-L	● CRI90 2700°K 38	AC110-240V 14A	20° 2	ON-OFF 0	<input type="checkbox"/> -01	<input type="checkbox"/> Bl. / Wh. -01
	● CRI90 3000°K 39	AC220-240V 14B	40° 4	PUSH/I-10V 1		<input checked="" type="checkbox"/> Crm./Chrm -32
	○ CRI90 4000°K 40		55° 5	L _C (Trailing and leading edge) F		
				DALI D		
				CASAMBI M		

Ref. **1 0 0 4 A - L** - **0 1** -

Regulaciones disponibles según voltaje_Dimming options according to voltage

AC110-240V	ON-OFF	AC220-240V	L _C (trailing and leading edge)
	PUSH/I-10V		CASAMBI
	DALI		

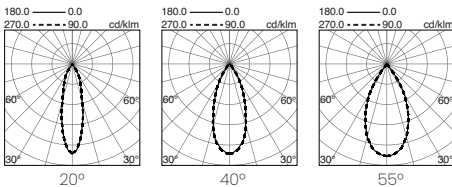

Otras potencias disponibles_Other available powers

7,2W	
CRI90	
2700°K 875lm	
3000°K 889lm	
4000°K 952lm	

SCOP

LARGE



Acabado blanco con embellecedor blanco o cromado
White finish with white or chrome baffle

Con Driver remoto
With Remote Driver

Acabados_Finishes



Accesorios – Accessories



18,6W

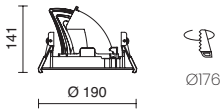

CRI90	CRI95 FASHION
2700°K 2143lm	3250°K 2180lm
3000°K 2221lm	
4000°K 2436lm	

Round	CRI – °K	Voltaje	Óptica	Regulación	Aro	Embellecedor
LED COB	CRI – °K	Voltage	Light beam	Dimming	Ring	Baffle
1004B-L	● CRI90 2700°K 38	AC110-240V 21A	20° 2	ON-OFF 0	□ -01	□ Bl. / Wh. -01
	● CRI90 3000°K 39	AC220-240V 21B	40° 4	PUSH/I-10V 1		■ Crm./Chrm -32
	○ CRI90 4000°K 40		55° 5	L,C (trailing and leading edge) F		
	○ CRI95 3250°K 51			DALI D		
				CASAMBI M		

Ref. **1 0 0 4 B - L** - 0 1 -

Regulaciones disponibles según voltaje_Dimming options according to voltage

CRI90 2700K-3000K-4000K	CRI95 FASHION 3250K
AC110-240V ON-OFF PUSH/I-10V DALI	AC110-240V ON-OFF PUSH/I-10V DALI
AC220-240V L,C (trailing and leading edge) CASAMBI	AC220-240V L,C (trailing and leading edge) CASAMBI

SCOP

LARGE

29,7W

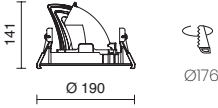

CRI90	CRI95 FASHION
2700°K 3325lm	3250°K 3382lm
3000°K 3446lm	
4000°K 3780lm	

Round LED COB	CRI – °K CRI – °K	Voltaje Voltage	Óptica Light beam	Regulación Dimming	Aro Ring	Embellecedor Baffle
1004B-L	● CRI90 2700°K 38 ● CRI90 3000°K 39 ● CRI90 4000°K 40 ● CRI95 3250°K 51	AC110-240V 33A AC220-240V 33B	20° 2 40° 4 55° 5	ON-OFF 0 PUSH/↓-10V 1 DALI D CASAMBI M	<input type="checkbox"/> -01	<input type="checkbox"/> Bl. / Wh. -01 <input checked="" type="checkbox"/> Crm./Chrm -32

Ref. **1 0 0 4 B - L** - **0 1** -

Regulaciones disponibles según voltaje_Dimming options according to voltage

CRI90 2700K-3000K-4000K

CRI95 FASHION 3250K

AC110-240V	ON-OFF PUSH/↓-10V DALI
-------------------	------------------------------

AC110-240V	ON-OFF PUSH/↓-10V DALI
-------------------	------------------------------

AC220-240V CASAMBI

AC220-240V CASAMBI

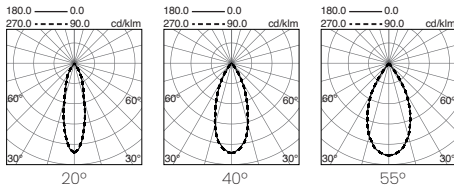

Otras potencias disponibles_Other available powers

17W

CRI82	CRI88	CRI92	CRI96
2000°K 1741lm	2500°K 2340lm	4000°K 2521lm	3000°K 2141lm
MEAT ●	BREAD ●	FISH ●	VEG.+FRUIT ●

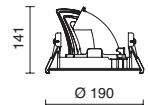

QUO

SMALL



Acabado blanco con embellecedor blanco o cromado
White finish with white or chrome baffle

Con Driver remoto
With Remote Driver

Acabados_Finishes



-01-01



-01-32

Accesorios – Accessories



Antideslumbrante
Anti-glare

■ A04P-1004-02



Prismatico
Prismatic

■ A47H-1004-92



QUO

SMALL

13,2W

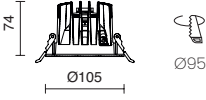

CRI90	
2700°K	1448lm
3000°K	1506lm
4000°K	1613lm

Round LED COB	CRI – °K CRI – °K	Voltaje Voltage	Óptica Light beam	Regulación Dimming	Aro Ring	Embellecedor Baffle
1005A-L	<ul style="list-style-type: none"> ● CRI90 2700°K 38 ● CRI90 3000°K 39 ○ CRI90 4000°K 40 	<ul style="list-style-type: none"> AC110-240V 14A AC220-240V 14B 	<ul style="list-style-type: none"> 20° 2 40° 4 55° 5 	<ul style="list-style-type: none"> ON-OFF 0 PUSH/I-10V 1 L,C (Trailing and leading edge) F DALI D CASAMBI M 	<ul style="list-style-type: none"> <input type="checkbox"/> -01 	<ul style="list-style-type: none"> <input type="checkbox"/> Bl. / Wh. -01 <input checked="" type="checkbox"/> Crm./Chrm -32

Ref. **1 0 0 5 A - L** - **0 1** -

Regulaciones disponibles según voltaje_Dimming options according to voltage

AC110-240V	ON-OFF	AC220-240V	L,C (trailing and leading edge)
	PUSH/I-10V		CASAMBI
	DALI		

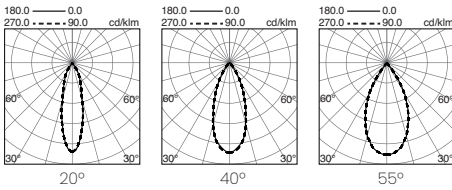

Otras potencias disponibles_Other available powers

7,2W	
CRI90	
2700°K 875lm	
3000°K 889lm	
4000°K 952lm	

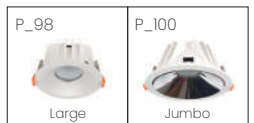

QUO

LARGE



Acabado blanco con embellecedor blanco o cromado
White finish with white or chrome baffle

Con Driver remoto
With Remote Driver

Acabados_Finishes



Accesorios – Accessories



18,6W

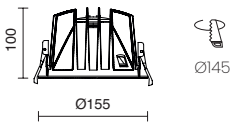

CRI90	CRI95 FASHION
2700°K 2143lm	3250°K 2180lm
3000°K 2221lm	
4000°K 2436lm	

Round LED COB	CRI – °K	Voltaje Voltage	Óptica Light beam	Regulación Dimming	Aro Ring	Embellecedor Baffle
1005B-L	<ul style="list-style-type: none"> ● CRI90 2700°K 38 ○ CRI90 3000°K 39 ○ CRI90 4000°K 40 ○ CRI95 3250°K 51 	<ul style="list-style-type: none"> AC110-240V 21A AC220-240V 21B 	<ul style="list-style-type: none"> 20° 2 40° 4 55° 5 	<ul style="list-style-type: none"> ON-OFF 0 PUSH/I-10V 1 L_C (trailing and leading edge) F DALI D CASAMBI M 	<ul style="list-style-type: none"> □ -01 	<ul style="list-style-type: none"> □ Bl. / wh. -01 ■ Crm./Chrm -32

Ref. **1 0 0 4 B - L** - 0 1 -

Regulaciones disponibles según voltaje_Dimming options according to voltage

CRI90 2700K-3000K-4000K	CRI95 FASHION 3250K
<ul style="list-style-type: none"> AC110-240V ON-OFF PUSH/I-10V DALI 	<ul style="list-style-type: none"> AC110-240V ON-OFF PUSH/I-10V DALI
<ul style="list-style-type: none"> AC220-240V L_C (trailing and leading edge) CASAMBI 	<ul style="list-style-type: none"> AC220-240V L_C (trailing and leading edge) CASAMBI

QUO

LARGE

29,7W

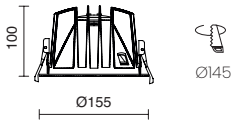

<i>CRI90</i>	<i>CRI95 FASHION</i>
2700°K 3325lm	3250°K 3382lm
3000°K 3446lm	
4000°K 3780lm	

Round LED COB	CRI – °K CRI – °K	Voltaje Voltage	Óptica Light beam	Regulación Dimming	Aro Ring	Embellededor Baffle
1005B-L	● CRI90 2700°K 38	AC110-240V 33A	20° 2	ON-OFF 0	□ -01	□ Bl. / Wh. -01
	● CRI90 3000°K 39	AC220-240V 33B	40° 4	PUSH/1-10V 1		■ Crm./Chrm -32
	○ CRI90 4000°K 40		55° 5	DALI D		
	○ CRI95 3250°K 51			CASAMBI M		

Ref. **1 0 0 5 B - L** - **0 1** -

Regulaciones disponibles según voltaje_Dimming options according to voltage

CRI90 2700K-3000K-4000K

CRI95 FASHION 3250K

AC110-240V ON-OFF
PUSH/1-10V
DALI

AC110-240V ON-OFF
PUSH/1-10V
DALI

AC220-240V CASAMBI

AC220-240V CASAMBI

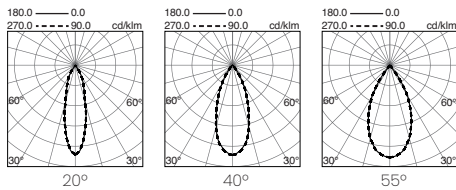

Otras potencias disponibles_Other available powers

17W

CRI82

2000°K **1741lm**

MEAT ●

CRI88

2500°K **2340lm**

BREAD ●

CRI92

4000°K **2521lm**

FISH ●

CRI96

3000°K **2141lm**

VEG.+FRUIT ●

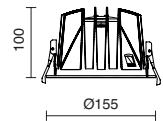

P_96



Small

P_100



Jumbo



Acabado blanco con embellecedor blanco o cromado
White finish with white or chrome baffle

Con Driver remoto
With Remote Driver

Acabados_Finishes



-01-01



-01-32

Accesorios – Accessories



Antideslumbrante
Anti-glare

■ A04P-1004-02



Prismatico
Prismatic

■ A47H-1004-92



QUO

JUMBO

33,8W

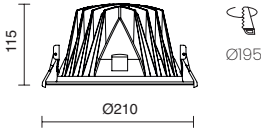

CRI90	CRI95
2700°K 3694lm	3250°K 3758lm
3000°K 3993lm	
4000°K 4200lm	

Round LED COB	CRI – °K CRI – °K	Voltaje Voltage	Óptica Light beam	Regulación Dimming	Aro Ring	Embellecedor Baffle
1005C-L	● CRI90 2700°K 38	AC110-240V 33A	20° 2	ON-OFF 0	<input type="checkbox"/> -01	<input type="checkbox"/> Bl. / Wh. -01
	● CRI90 3000°K 39	AC220-240V 33B	40° 4	PUSH/I-10V 1		<input checked="" type="checkbox"/> Crm./Chrm -32
	○ CRI90 4000°K 40		55° 5	DALI D		
	○ CRI95 3250°K 51			CASAMBI M		

Ref. **1 0 0 5 C - L** - **0 1** -

Regulaciones disponibles según voltaje_Dimming options according to voltage

CRI90 2700K-3000K-4000K

CRI95 FASHION 3250K

AC110-240V ON-OFF
PUSH/I-10V
DALI

AC110-240V ON-OFF
PUSH/I-10V
DALI

AC220-240V CASAMBI

AC220-240V CASAMBI

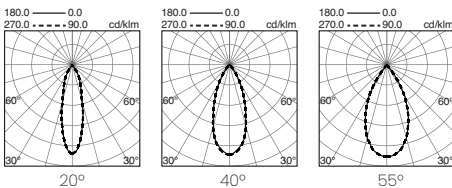

PALMA



-01



-02



-30



-32



-45



-48

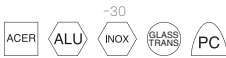

-30



Acabado blanco, negro, inox (-30), cromado (-32), cromado mate (-45) o níquel mate (-48)
 White, black, stainless steel (-30), chrome (-32), matt chrome (-45) or matt nickel finish (-48)

Con Driver remoto
 With Remote Driver

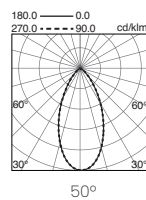
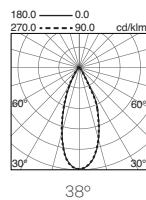
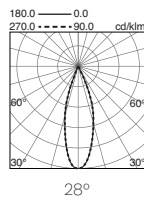
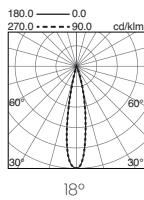

PALMA

4,7W

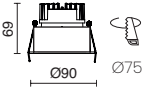

CRI90	
2700°K	650lm
3000°K	680lm
4000°K	719lm

Round LED COB	CRI – °K		Voltaje Voltage	Óptica Light beam	Regulación Dimming	Acabado Finish
750A-L	● CRI90 2700°K 38		AC110-240V 06A	18° 1	ON-OFF 0	□ Bl. / Wh. -01
	○ CRI90 3000°K 39		AC220-240V 06B	28° 2	PUSH/I-10V 1	■ Ng. / Blk. -02
	○ CRI90 4000°K 40			38° 3	DALI D	□ Inox -30
				48° 5	L _r C (Trailing and leading edge) F	■ Crm./Chrm -32
						■ Crm. Mat -45
						□ Nickl. Mat -48

Ref. **7 5 0 A - L** -

Regulaciones disponibles según voltaje_Dimming options according to voltage

AC110-240V

ON-OFF

PUSH/I-10V

DALI

AC220-240V

ON-OFF

L_rC (Trailing and leading edge)

PALMA

10,1W – 11,8W

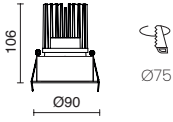

10,6W	10,1W	11,8W	10,6W
<i>CRI90</i>	<i>CRI97</i>	<i>CRI95 (DTW)</i>	<i>TUNABLE WHITE</i>
2700°K 1317lm	2700°K 923lm	2000°K 28lm	2700°K 1278lm
3000°K 1376lm	3000°K 949lm	3000°K 1179lm	6500°K 1563lm
4000°K 1456lm	4000°K 1031lm		

Round LED COB	CRI – °K CRI – °K	Voltage Voltage	Óptica Light beam	Regulación Dimming	Acabado Finish
750A-L	● CRI90 2700°K 38	AC110-240V 13A	18° 1	ON-OFF 0	□ Bl. / Wh. -01
	○ CRI90 3000°K 39	AC220-240V 13B	28° 2	L _C (trailing and leading edge) F	■ Ng. / Blk. -02
	○ CRI90 4000°K 40		38° 3	PUSH/I-10V I	□ Inox -30
	● CRI97 2700°K 53		48° 5	DALI D	■ Crm./Chrm -32
	○ CRI97 3000°K 54			CASAMBI M	■ Crm. Mat. -45
	○ CRI97 4000°K 55				□ Nickl. Mat -48
	● TUNABLE WHITE 2700°K - 6500°K 56				
	● CRI95 DIM TO WARM 2000°K-3000°K 57				

Ref. **7 5 0 A - L**

Regulaciones disponibles según voltaje...Dimming options according to voltage

CRI90 2700K-3000K-4000K	AC110-240V PUSH/I-10V DALI	AC220-240V ON-OFF L _C (Trailing and leading edge) CASAMBI
CRI97 2700K-3000K-4000K	AC110-240V PUSH/I-10V DALI	AC220-240V ON-OFF L _C (Trailing and leading edge) CASAMBI
CRI95 (DTW) 2000K-3000K	AC110-240V PUSH/I-10V	AC220-240V DALI CASAMBI
TUNABLE WHITE 2700K-6500K	AC220-240V PUSH/I-10V	

PALMA



Otras potencias disponibles...Other available powers

15,6W

CR190

2700°K 1940lm

3000°K 2028lm

4000°K 2145lm

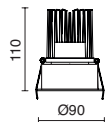

CARPO



Acabado blanco – White finish
Con Driver remoto – With Remote Driver

Con Driver remoto
With Remote Driver

4,7W



CRI90	
2700°K	650lm
3000°K	680lm
4000°K	719lm

Round LED COB	CRI – °K	Voltaje Voltage	Óptica Light beam	Regulación Dimming	Acabado Finish
781B-L	<ul style="list-style-type: none"> ● CRI90 2700°K 38 ○ CRI90 3000°K 39 ○ CRI90 4000°K 40 	<ul style="list-style-type: none"> AC110-240V 06A AC220-240V 06B 	<ul style="list-style-type: none"> 18° 1 28° 2 38° 3 48° 5 	<ul style="list-style-type: none"> ON-OFF 0 PUSH/I-10V 1 DALI D L,C (trailing and leading edge) F 	<ul style="list-style-type: none"> □ Bl. / Wh. -01

Ref. **7 8 1 B - L** **- 0 1**

Regulaciones disponibles según voltaje...Dimming options according to voltage

AC110-240V	AC220-240V
ON-OFF	ON-OFF
PUSH/I-10V	L,C (trailing and leading edge)
DALI	

CARPO

15,6W

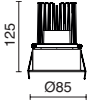

CRI90	
2700°K	1940lm
3000°K	2028lm
4000°K	2145lm

Round LED COB	CRI – °K CRI – °K	Voltaje Voltage	Óptica Light beam	Regulación Dimming	Acabado Finish
781B-L	<ul style="list-style-type: none"> ● CRI90 2700°K 38 ○ CRI90 3000°K 39 ○ CRI90 4000°K 40 	AC220-240V 18B	<ul style="list-style-type: none"> 18° 1 28° 2 38° 3 48° 5 	<ul style="list-style-type: none"> ON-OFF 0 L/C (Trailing and leading edge) F PUSH/I-10V 1 DALI D CASAMBI M 	<ul style="list-style-type: none"> □ Bl. / Wh. -01

Ref. **7 8 1 B - L** **1 8 B** **- 0 1**

Regulaciones disponibles según voltaje_Dimming options according to voltage

AC220-240V
<ul style="list-style-type: none"> ON-OFF L/C (trailing and leading edge) PUSH/I-10V DALI CASAMBI

Otras potencias disponibles...Other available powers

10,6W	10,1W	11,8W	10,6W
CRI90	CRI97	CRI95	TUNABLE WHITE
2700°K 1317lm	2700°K 923lm	2000°K 28lm	2700°K 1278lm
3000°K 1376lm	3000°K 949lm	3000°K 1179lm	6500°K 1563lm
4000°K 1456lm	4000°K 1031lm		

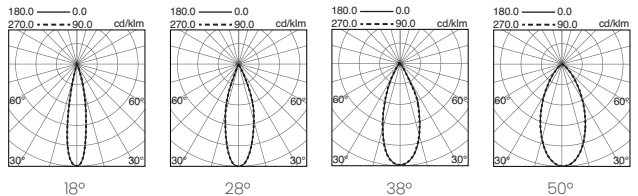

MINI LUNA



Acabado blanco, negro, gris, cromado (32), cromado mate (-45) o níquel mate (-48)
 White, black, grey, chrome (-32), matt chrome (-45) or matt nickel finish (-48)

Con Driver remoto
 With Remote Driver

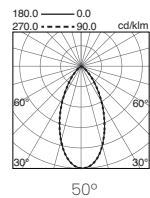
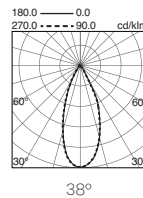
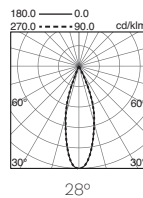
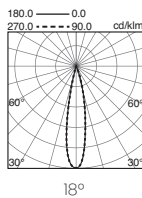

MINI LUNA

10,1W – 11,8W

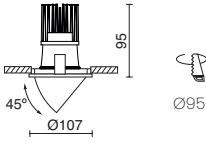

10,6W	10,1W	11,8W	10,6W
<i>CRI90</i>	<i>CRI97</i>	<i>CRI95 (DTW)</i>	<i>TUNABLE WHITE</i>
2700°K 1317lm	2700°K 923lm	2000°K 28lm	2700°K 1278lm
3000°K 1376lm	3000°K 949lm	3000°K 1179lm	6500°K 1563lm
4000°K 1456lm	4000°K 1031lm		

Round LED COB	CRI – °K		Voltaje Voltage	Óptica Light beam	Regulación Dimming	Acabado Finish	
741A-L	● CRI90 2700°K	38	AC110-240V 13A	18° 1	ON-OFF 0	□ Bl. / Wh.	-01
	○ CRI90 3000°K	39	AC220-240V 13B	28° 2	L _C (trailing and leading edge) F	■ Ng. / Blk.	-02
	○ CRI90 4000°K	40		38° 3	PUSH/I-10V 1	■ Gris / Grey	-03
	● CRI97 2700°K	53		48° 5	DALI D	■ Crm./Chrm	-32
	○ CRI97 3000°K	54			CASAMBI M	■ Crm. Mat.	-45
	○ CRI97 4000°K	55				□ Nickl. Mat	-48
	● TUNABLE WHITE 2700°K - 6500°K	56					
	● CRI95 DIM TO WARM 2000°K-3000°K	57					

Ref. **7 4 1 A - L**

Regulaciones disponibles según voltaje...Dimming options according to voltage

CRI90 2700K-3000K-4000K	AC110-240V PUSH/I-10V DALI	AC220-240V ON-OFF L _C (Trailing and leading edge) CASAMBI
CRI97 2700K-3000K-4000K	AC110-240V PUSH/I-10V DALI	AC220-240V ON-OFF L _C (Trailing and leading edge) CASAMBI
CRI95 (DTW) 2000K-3000K	AC110-240V PUSH/I-10V	AC220-240V DALI CASAMBI
TUNABLE WHITE 2700K-6500K	AC220-240V PUSH/I-10V	



NIX



780A-



780E-



780B-



780F-



Acabado blanco, cromado mate (-45) o níquel mate (-48)
White, matt chrome (-45) or matt nickel finish (-48)



Con Driver remoto
With Remote Driver

INEL



A13A-



A13B-





Acabado blanco – White finish

Con Driver remoto
With Remote Driver

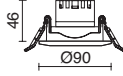
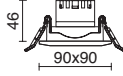
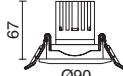
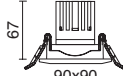

INEL

	A13A- Redondo Round	A13B- Cuadrado Square	
6W			3000K 675lm 4000K 707lm
10W			3000K 1125lm 4000K 1178lm
			

LED COB	CRI – °K CRI – °K	Potencia Power	Voltaje Voltage	Óptica Light beam	Regulación Dimming	Acabado Finish
A13A-L	☉ CRI90 3000°K 39 ○ CRI90 4000°K 40	6W 06	AC110-240V A	25° 2	ON-OFF 0	□ Bl. / Wh. -01
A13B-L	○ CRI90 4000°K 40	10W 10	AC220-240V B	38° 3 60° 6	PUSH/I-10V 1 DALI D L,C (trailing and leading edge) F	

Ref. **A 1 3 - L** - **0 1**

Regulaciones disponibles según voltaje...Dimming options according to voltage

AC110-240V	ON-OFF	AC220-240V	L,C (trailing and leading edge)
	PUSH/I-10V		
	DALI		

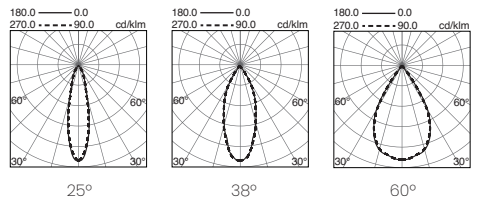

LEDA



Acabado blanco, negro o gris – White, black or grey finish

Con Driver remoto
With Remote Driver



LEDA

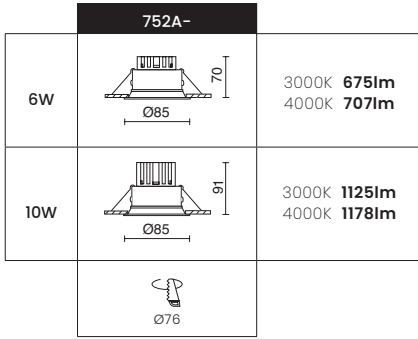

LED COB	CRI – °K CRI – °K	Potencia Power	Voltaje Voltage	Óptica Light beam	Regulación Dimming	Acabado Finish
752A-L	● CRI90 3000°K 39 ○ CRI90 4000°K 40	6W 06 10W 10	AC110-240V A AC220-240V B	25° 2 38° 3 60° 6	ON-OFF 0 PUSH/1-10V 1 DALI D LC (trailing and leading edge) F	□ Bl. / Wh. -01 ■ Ng. / Blk. -02 ■ Gris/Grey -03

Ref. **7 5 2 A - L** -

Regulaciones disponibles según voltaje _ Dimming options according to voltage

AC110-240V	ON-OFF	AC220-240V	LC (trailing and leading edge)
	PUSH/1-10V		
	DALI		

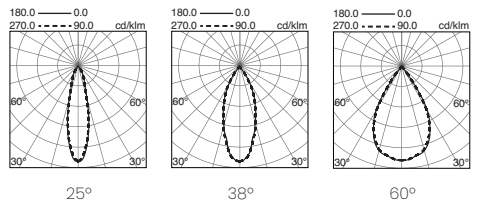

LEN



798B-



798C-



Acabado blanco – White finish

Con Driver remoto
With Remote Driver





9x15 mm

Para techo de yeso – For plaster ceiling

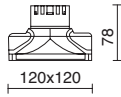
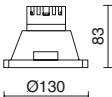
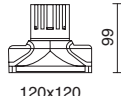
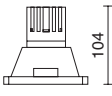

LEN

	798B-	798C-	
6W			3000K 675lm 4000K 707lm
10W			3000K 1125lm 4000K 1178lm
	 124x124	 Ø133	

LED COB	CRI – °K CRI – °K	Potencia Power	Voltaje Voltage	Óptica Light beam	Regulación Dimming	Acabado Finish
798B-L	☉ CRI90 3000°K 39	6W 06	AC110-240V A	25° 2	ON-OFF 0	☐ Bl. / Wh. -01
798C-L	○ CRI90 4000°K 40	10W 10	AC220-240V B	38° 3	PUSH/I-10V 1	
				60° 6	DALI D	
					L,C (trailing and leading edge) F	

Ref. **7 9 8 - L** - - - - -

Regulaciones disponibles según voltaje_Dimming options according to voltage

AC110-240V	ON-OFF	AC220-240V	L,C (trailing and leading edge)
	PUSH/I-10V		
	DALI		

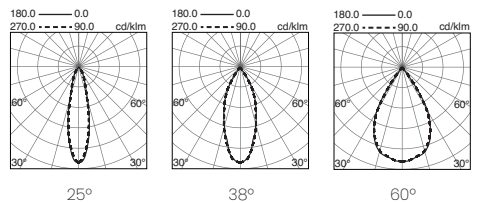

ATOLON



Acabado blanco, negro o gris – White, black or grey finish

Con Driver remoto
With Remote Driver

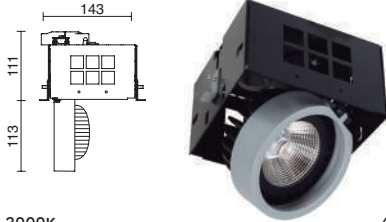

3000K

LED COB 17W 2180lm

- 738Q-L3125B-01
- 738Q-L3125B-02
- 738Q-L3125B-03

4000K

LED COB 17W 2250lm

- 738Q-L3325B-01
- 738Q-L3325B-02
- 738Q-L3325B-03



- 738Q-L31R2B-01
- 738Q-L31R2B-02
- 738Q-L31R2B-03

- 738Q-L33R2B-01
- 738Q-L33R2B-02
- 738Q-L33R2B-03



- 738Q-L31I7BIM-01
- 738Q-L31I7BIM-02
- 738Q-L31I7BIM-03

- 738Q-L33I7BIM-01
- 738Q-L33I7BIM-02
- 738Q-L33I7BIM-03

CASAMBI

3000K

LED COB 17W 2210lm

- 738R-L3125B-01
- 738R-L3125B-02
- 738R-L3125B-03

4000K

LED COB 17W 2280lm

- 738R-L3325B-01
- 738R-L3325B-02
- 738R-L3325B-03



- 738R-L31R2B-01
- 738R-L31R2B-02
- 738R-L31R2B-03

- 738R-L33R2B-01
- 738R-L33R2B-02
- 738R-L33R2B-03



- 738R-L31I7B2M-01
- 738R-L31I7B2M-02
- 738R-L31I7B2M-03

- 738R-L33I7BIM-01
- 738R-L33I7BIM-02
- 738R-L33I7BIM-03

CASAMBI

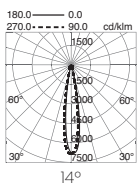

3000K		
h (m)	d (m)	E (lux)
1,00	0,29	12485
2,00	0,58	3121
3,00	0,87	1387
4,00	1,16	780
5,00	1,45	499

14°

4000K		
h (m)	d (m)	E (lux)
1,00	0,29	14782
2,00	0,58	3696
3,00	0,87	1642
4,00	1,16	924
5,00	1,45	591

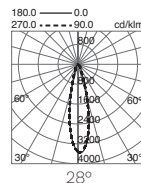

3000K		
h (m)	d (m)	E (lux)
1,00	0,54	6537
2,00	1,08	1634
3,00	1,62	726
4,00	2,16	409
5,00	2,70	261

28°

4000K		
h (m)	d (m)	E (lux)
1,00	0,54	7027
2,00	1,08	1757
3,00	1,62	781
4,00	2,16	439
5,00	2,70	281

ATOLON

Marcos – Frames





	<ul style="list-style-type: none">  A45A-738-01  A45A-738-02  A45A-738-03 			152x152
	<ul style="list-style-type: none">  A45B-738-01  A45B-738-02  A45B-738-03 			300x152
	<ul style="list-style-type: none">  A45C-738-01  A45C-738-02  A45C-738-03 			450x152
	<ul style="list-style-type: none">  A45D-738-01  A45D-738-02  A45D-738-03 			600x152
	<ul style="list-style-type: none">  A45E-738-01  A45E-738-02  A45E-738-03 			300x300

ACER

Acabado blanco, negro o gris – White, black or grey finish







Filtros de conversión para pescado, marisco, verdura, carne o pan
Conversion filters for fish, seafood, vegetables, meat or bread

	SEAFOOD	A14A-738-00	for 3000K
	VEG+FRUIT	A14A-738-00	
	FISH	A14A-738-00	for 4000K
	MEAT	A14B-738-00	
	BREAD	A14C-738-00	



Porta filtros – Support for filters

	<ul style="list-style-type: none">  A44A-772-01  A44A-772-02  A44A-772-03 	
---	---	--

VALGUS



Acabado blanco – White finish

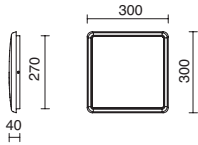

LED SMD 18W 1494lm **3000K**

LED SMD 18W 1584lm **4000K**

□ 806B-L31RCB-01

□ 806B-L33RCB-01

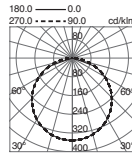

3000K

h (m)	d (m)	E (lux)
1,00	3,15	518
2,00	6,30	130
3,00	9,45	58
4,00	12,60	32
5,00	15,75	21

4000K

h (m)	d (m)	E (lux)
1,00	3,15	550
2,00	6,30	138
3,00	9,45	61
4,00	12,60	34
5,00	15,75	22

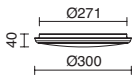

LED SMD 18W 1530lm **3000K**

LED SMD 18W 1600lm **4000K**

□ 806A-L31RCA-01

□ 806A-L33RCA-01



□ 806A-L3118Z-01

□ 806A-L3318Z-01



□ 806A-L3118R-01

□ 806A-L3318R-01



EMERGENCY (3h) 4W 340lm

EMERGENCY (3h) 4W 355lm

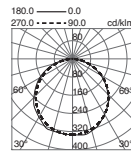

3000K

h (m)	d (m)	E (lux)
1,00	3,15	516
2,00	6,30	129
3,00	9,45	57
4,00	12,60	32
5,00	15,75	21

4000K

h (m)	d (m)	E (lux)
1,00	3,15	540
2,00	6,30	135
3,00	9,45	60
4,00	12,60	34
5,00	15,75	22



BUIS RANGE EXTENSION

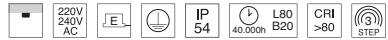

Acabado blanco o gris – White or grey finish

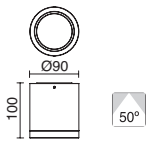

LED COB 14W 1200lm **3000K**

□ 805A-L3115B-01

E ■ 805A-L3115B-02

■ 805A-L3115B-03

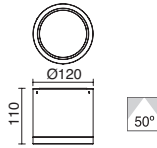

LED COB 24W 2320lm **3000K**

□ 805B-L3125B-01

E ■ 805B-L3125B-02

■ 805B-L3125B-03

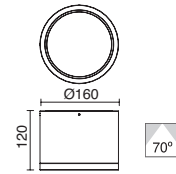

LED COB 32W 3320lm **3000K**

□ 805C-L3135B-01

E ■ 805C-L3135B-02

■ 805C-L3135B-03

LED COB 14W 1280lm **4000K**

□ 805A-L3315B-01

E ■ 805A-L3315B-02

■ 805A-L3315B-03

LED COB 24W 2420lm **4000K**

□ 805B-L3325B-01

E ■ 805B-L3325B-02

■ 805B-L3325B-03

LED COB 32W 3430lm **4000K**

□ 805C-L3335B-01

E ■ 805C-L3335B-02

■ 805C-L3335B-03

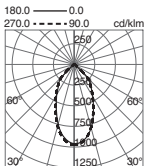

805A-L3115A

h (m)	d (m)	E (lux)
1,00	0,93	1102
2,00	1,86	276
3,00	2,79	122
4,00	3,72	69
5,00	4,65	44

805A-L3115A

h (m)	d (m)	E (lux)
1,00	0,93	1175
2,00	1,86	294
3,00	2,79	131
4,00	3,72	73
5,00	4,65	47

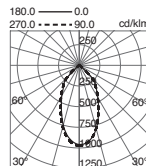

805B-L3125A

h (m)	d (m)	E (lux)
1,00	0,93	2121
2,00	1,86	530
3,00	2,79	236
4,00	3,72	133
5,00	4,65	85

805B-L325A

h (m)	d (m)	E (lux)
1,00	0,93	2212
2,00	1,86	553
3,00	2,79	246
4,00	3,72	138
5,00	4,65	88

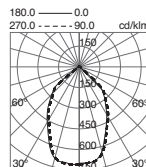

805C-L3135A

h (m)	d (m)	E (lux)
1,00	1,40	1780
2,00	2,80	445
3,00	4,20	198
4,00	5,60	111
5,00	7,00	71

805C-L3325A

h (m)	d (m)	E (lux)
1,00	1,40	1897
2,00	2,80	474
3,00	4,20	211
4,00	5,60	119
5,00	7,00	76



HIDRA

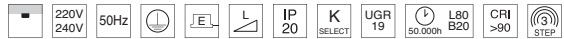

Acabado blanco o negro con embellecedores blanco, negro u oro
White or black finish with white, black or gold trims

	2700K	236lm
	3000K	2572lm
	4000K	244lm



LED COB 25W

- □ 835E-L4125B2F-01-01
- ■ 835E-L4125B2F-01-02
- ■ 835E-L4125B2F-01-47
- ■ 835E-L4125B2F-02-02
- ■ 835E-L4125B2F-02-47



LED COB 25W

- □ 835E-L4125B3F-01-01
- ■ 835E-L4125B3F-01-02
- ■ 835E-L4125B3F-01-47
- ■ 835E-L4125B3F-02-02
- ■ 835E-L4125B3F-02-47



LED COB 25W

- □ 835E-L4125B6F-01-01
- ■ 835E-L4125B6F-01-02
- ■ 835E-L4125B6F-01-47
- ■ 835E-L4125B6F-02-02
- ■ 835E-L4125B6F-02-47

Rejilla antideslumbrante – Anti-glare grille

- A04R-835.20.01
- A04R-835.20.02
- A04R-835.20.47





HIDRA

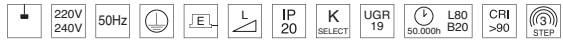

Acabado blanco o negro con embellecedores blanco, negro u oro
White or black finish with white, black or gold trims

	2700K	236lm
	3000K	2572lm
	4000K	244lm



LED COB 25W

- 835B-L4125B2F-01-01
- 835B-L4125B2F-01-02
- 835B-L4125B2F-01-47
- 835B-L4125B2F-02-02
- 835B-L4125B2F-02-47



LED COB 25W

- 835B-L4125B3F-01-01
- 835B-L4125B3F-01-02
- 835B-L4125B3F-01-47
- 835B-L4125B3F-02-02
- 835B-L4125B3F-02-47



LED COB 25W

- 835B-L4125B6F-01-01
- 835B-L4125B6F-01-02
- 835B-L4125B6F-01-47
- 835B-L4125B6F-02-02
- 835B-L4125B6F-02-47

Rejilla antideslumbrante - Anti-glare grille

- A04R-835.20.01
- A04R-835.20.02
- A04R-835.20.47





BILOG



Acabado blanco o negro – White or negro finish

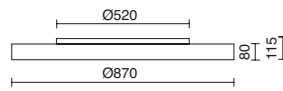
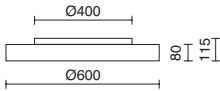

LED SMD 44W 3980lm **3000K**

- 801A-L3148B-01
- 801A-L3148B-02

- 801A-L31RDB-01
- 801A-L31RDB-02



LED SMD 96W 7944lm **3000K**

- 801B-L31A3B-01
- 801B-L31A3B-02

- 801B-L31RDB-01
- 801B-L31RDB-02



LED SMD 44W 4563lm **4000K**

- 801A-L3348B-01
- 801A-L3348B-02

- 801A-L33RDB-01
- 801A-L33RDB-02



LED SMD 96W 9108lm **4000K**

- 801B-L33A3B-01
- 801B-L33A3B-02

- 801B-L33RDB-01
- 801B-L33RDB-02

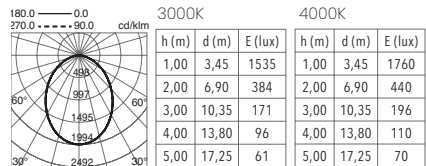



BILOG



Acabado blanco o negro – White or negro finish

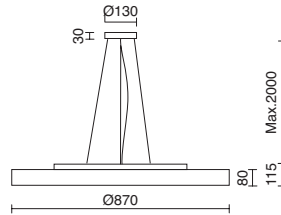
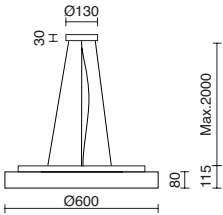

LED SMD 44W 3980lm **3000K**

- 80IC-L3148B-01
- 80IC-L3148B-02

LED SMD 96W 7944lm **3000K**

- 80ID-L31A3B-01
- 80ID-L31A3B-02

- 80IC-L31RDB-01
- 80IC-L31RDB-02



- 80ID-L31RDB-01
- 80ID-L31RDB-02



LED SMD 44W 4563lm **4000K**

- 80IC-L3348B-01
- 80IC-L3348B-02

LED SMD 96W 9108lm **4000K**

- 80ID-L33A3B-01
- 80ID-L33A3B-02

- 80IC-L33RDB-01
- 80IC-L33RDB-02



- 80ID-L33RDB-01
- 80ID-L33RDB-02

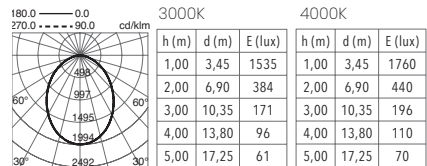



Commette











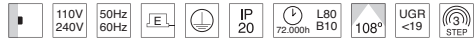
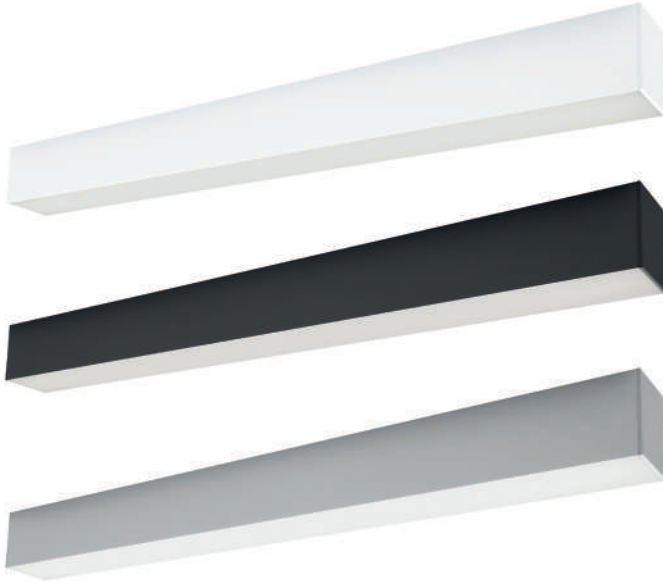

FENIX

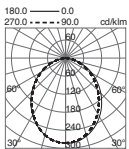
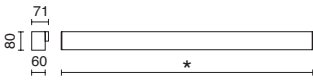
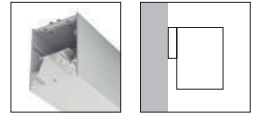
Wall



Acabado blanco, negro o gris – White, black or grey finish



Ceiling	Recessed	Recessed Trimless	Pendant Dir	Pendant Dir/Indir.
 P_ 140	 P_ 142	 P_ 144	 P_ 146	 P_ 148

FENIX



Wall

FENIX Wall LED SMD	CRI – °K CRI – °K	Potencia Power	Voltaje Voltage	Óptica Light beam	Regulación Dimming	Acabado Finish
1066A-L	● CRI80 2700°K 30	11,65W 12	AC110-240V A	108° A	ON-OFF 0	□ Bl. / Wh. -01
1066B-L	● CRI80 3000°K 31	17,50W 18			DALI D	■ Ng. / Blk. -02
1066C-L	○ CRI80 4000°K 33	23,30W 24				■ Gris / Grey -03
1066D-L	● CRI90 3000°K 39	29,15W 30				
1066E-L	● CRI90 4000°K 40	34,95W 35				
1066F-L		40,80W 41				
1066G-L		46,60W 47				

Ref. 1 0 6 6 - L A A -

Medidas disponibles según potencias _ Available sizes according to power ratings

	1066A-	1066B-	1066C-	1066D-	1066E-	1066F-	1066G-
*	581mm	861mm	1141mm	1431mm	1711mm	1991mm	2271mm
	11,65W (12)	17,50W (18)	23,30W (24)	29,15W (30)	34,95W (35)	40,80W (41)	46,60W (47)
CR80 2700K (30)	1905lm	2855lm	3810lm	4760lm	5715lm	6665lm	7620lm
CR80 3000K (31)	1960lm	2940lm	3920lm	4900lm	5880lm	6860lm	7840lm
CR80 4000K (33)	2070lm	3105lm	4140lm	5175lm	6210lm	7245lm	8280lm
CR90 3000K (39)	1670lm	2505lm	3340lm	4175lm	5010lm	5845lm	6680lm
CR90 4000K (40)	1745lm	2620lm	3490lm	4365lm	5235lm	6110lm	6980lm

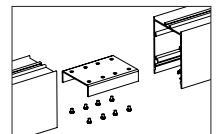

Unión línea continua – Continuous line connection

A58E-1061-41

ACER



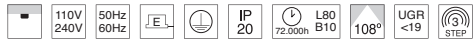

FENIX

 Ceiling

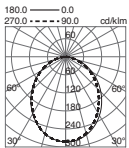
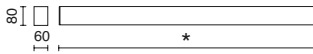

Acabado blanco, negro o gris – White, black or grey finish



 Wall (Down) P_ 138	 Recessed P_ 132	 Recessed Trimless P_ 134	 Pendant Dir P_ 136	 Pendant Dir/Indir. P_ 138
--	---	--	--	--

FENIX



Ceiling

 FENIX
Ceiling
LED SMD

 CRI – °K
CRI – °K

 Potencia
Power

 Voltaje
Voltage

 Óptica
Light beam

 Regulación
Dimming

 Acabado
Finish

1062A-L	● CRI80 2700°K 30	11,65W 12	AC110-240V A	108° A	ON-OFF 0	□ Bl. / Wh. -01
1062B-L	● CRI80 3000°K 31	17,50W 18			DALI D	■ Ng. / Blk. -02
1062C-L	○ CRI80 4000°K 33	23,30W 24				■ Gris / Grey -03
1062D-L	● CRI90 3000°K 39	29,15W 30				
1062E-L	○ CRI90 4000°K 40	34,95W 35				
1062F-L		40,80W 41				
1062G-L		46,60W 47				

Ref. 1 0 6 2 - L A A -

Medidas disponibles según potencias... Available sizes according to power ratings

	1062A-	1062B-	1062C-	1062D-	1062E-	1062F-	1062G-
*	581mm	861mm	1141mm	1431mm	1711mm	1991mm	2271mm
	11,65W (12)	17,50W (18)	23,30W (24)	29,15W (30)	34,95W (35)	40,80W (41)	46,60W (47)
CR80 2700K (30)	1905lm	2855lm	3810lm	4760lm	5715lm	6665lm	7620lm
CR80 3000K (31)	1960lm	2940lm	3920lm	4900lm	5880lm	6860lm	7840lm
CR80 4000K (33)	2070lm	3105lm	4140lm	5175lm	6210lm	7245lm	8280lm
CR90 3000K (39)	1670lm	2505lm	3340lm	4175lm	5010lm	5845lm	6680lm
CR90 4000K (40)	1745lm	2620lm	3490lm	4365lm	5235lm	6110lm	6980lm

 Acc.
Codo
LED SMD

 CRI – °K
CRI – °K

 Potencia
Power

 Voltaje
Voltage

 Óptica
Light beam

 Regulación
Dimming

 Acabado
Finish

B61A-L	● CRI80 2700°K 30	5,84W 06	AC110-240V A	108° A	ON-OFF 0	□ Bl. / Wh. -01
	● CRI80 3000°K 31		AC220-240V B		DALI D	■ Ng. / Blk. -02
	○ CRI80 4000°K 33					■ Gris / Grey -03
	● CRI90 3000°K 39					
	○ CRI90 4000°K 40					

Ref. B 6 1 A - L 0 6 A -

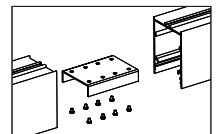

Unión línea continua – Continuous line connection

A58E-1061-41

ACER



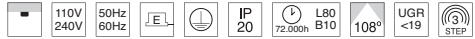

FENIX

 Recessed

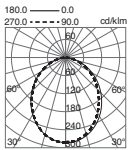
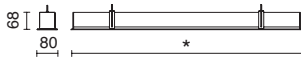

Acabado blanco, negro o gris – White, black or grey finish



 Wall (Down) P_ 138	 Ceiling P_ 140	 Recessed Trimless P_ 144	 Pendant Dir P_ 146	 Pendant Dir/Indir. P_ 148
--	--	--	--	---

FENIX



Recessed

 FENIX
Recessed
LED SMD

 CRI – °K
CRI – °K

 Potencia
Power

 Voltaje
Voltage

 Óptica
Light beam

 Regulación
Dimming

 Acabado
Finish

1065A-L	● CRI80 2700°K 30	11,65W 12	AC110-240V A	108° A	ON-OFF 0	□ Bl. / Wh. -01
1065B-L	● CRI80 3000°K 31	17,50W 18			DALI D	■ Ng. / Blk. -02
1065C-L	○ CRI80 4000°K 33	23,30W 24				■ Gris / Grey -03
1065D-L	● CRI90 3000°K 39	29,15W 30				
1065E-L	○ CRI90 4000°K 40	34,95W 35				
1065F-L		40,80W 41				
1065G-L		46,60W 47				

Ref. 1 0 6 5 - L A A -

Medidas disponibles según potencias... Available sizes according to power ratings

	1065A-	1065B-	1065C-	1065D-	1065E-	1065F-	1065G-
*	596mm	876mm	1156mm	1442mm	1722mm	2002mm	2282mm
	582x68mm	862x68mm	1142x68mm	1428x68mm	1708x68mm	1988x68mm	2268x68mm
	11,65W (12)	17,50W (18)	23,30W (24)	29,15W (30)	34,95W (35)	40,80W (41)	46,60W (47)
CR80 2700K (30)	1905lm	2855lm	3810lm	4760lm	5715lm	6665lm	7620lm
CR80 3000K (31)	1960lm	2940lm	3920lm	4900lm	5880lm	6860lm	7840lm
CR80 4000K (33)	2070lm	3105lm	4140lm	5175lm	6210lm	7245lm	8280lm
CR90 3000K (39)	1670lm	2505lm	3340lm	4175lm	5010lm	5845lm	6680lm
CR90 4000K (40)	1745lm	2620lm	3490lm	4365lm	5235lm	6110lm	6980lm

 Acc.
Codo
LED SMD

 CRI – °K
CRI – °K

 Potencia
Power

 Voltaje
Voltage

 Óptica
Light beam

 Regulación
Dimming

 Acabado
Finish

B65A-L	● CRI80 2700°K 30	5,84W 06	AC110-240V A	108° A	ON-OFF 0	□ Bl. / Wh. -01
	● CRI80 3000°K 31		AC220-240V B		DALI D	■ Ng. / Blk. -02
	○ CRI80 4000°K 33					■ Gris / Grey -03
	● CRI90 3000°K 39					
	○ CRI90 4000°K 40					

Ref. B 6 5 A - L 0 6 A -

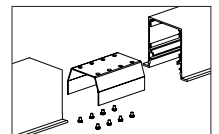

Unión línea continua – Continuous line connection

A58F-1065-41











ACER

FENIX

 Recessed
 Trimless



 ALU
 PC MAT
 ALU PAINT



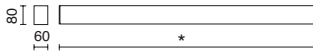

  110V 240V  50Hz 60Hz  EEL   JP 20  L80 B10 72.000h  108°  UGR <19  STEP

Acabado blanco, negro o gris – White, black or grey finish

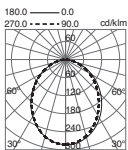
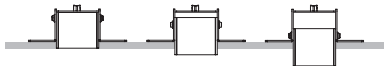

Sistema Trimless – Trimless system



Wall (Down)  P_ 138	Ceiling  P_ 140	Recessed  P_ 142	Pendant Dir  P_ 146	Pendant Dir/Indir.  P_ 148
---	---	--	---	--

FENIX



FENIX Trimless LED SMD	CRI – °K CRI – °K	Potencia Power	Voltaje Voltage	Óptica Light beam	Regulación Dimming	Acabado Finish
1063A-L	● CRI80 2700°K 30	11,65W 12	AC110-240V A	108° A	ON-OFF 0	<input type="checkbox"/> Bl. / Wh. -01
1063B-L	● CRI80 3000°K 31	17,50W 18			DALI D	<input type="checkbox"/> Ng. / Blk. -02
1063C-L	○ CRI80 4000°K 33	23,30W 24				<input type="checkbox"/> Gris / Grey -03
1063D-L	● CRI90 3000°K 39	29,15W 30				
1063E-L	● CRI90 4000°K 40	34,95W 35				
1063F-L	○ CRI90 4000°K 40	40,80W 41				
1063G-L		46,60W 47				

Ref. **1 0 6 3 - L** **A A** -

Medidas disponibles según potencias _ Available sizes according to power ratings

	1063A-	1063B-	1063C-	1063D-	1063E-	1063F-	1063G-
*	581mm	861mm	1141mm	1431mm	1711mm	1991mm	2271mm
	583x62mm	863x62mm	1143x62mm	1433x62mm	1713x62mm	1993x62mm	2273x62mm
	11,65W (12)	17,50W (18)	23,30W (24)	29,15W (30)	34,95W (35)	40,80W (41)	46,60W (47)
CR80 2700K (30)	1905lm	2855lm	3810lm	4760lm	5715lm	6665lm	7620lm
CR80 3000K (31)	1960lm	2940lm	3920lm	4900lm	5880lm	6860lm	7840lm
CR80 4000K (33)	2070lm	3105lm	4140lm	5175lm	6210lm	7245lm	8280lm
CR90 3000K (39)	1670lm	2505lm	3340lm	4175lm	5010lm	5845lm	6680lm
CR90 4000K (40)	1745lm	2620lm	3490lm	4365lm	5235lm	6110lm	6980lm



Acc. Codo LED SMD	CRI – °K CRI – °K	Potencia Power	Voltaje Voltage	Óptica Light beam	Regulación Dimming	Acabado Finish
B61A-L	● CRI80 2700°K 30	5,84W 06	AC110-240V A	108° A	ON-OFF 0	<input type="checkbox"/> Bl. / Wh. -01
	● CRI80 3000°K 31		AC220-240V B		DALI D	<input type="checkbox"/> Ng. / Blk. -02
	○ CRI80 4000°K 33				<input type="checkbox"/> Gris / Grey -03	
	● CRI90 3000°K 39					
	● CRI90 4000°K 40					

Ref. **B 6 1 A - L** **0 6** **A** -

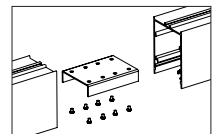

Unión línea continua – Continuous line connection

A58E-1061-41

ACER



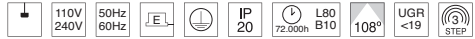

FENIX

 Pendant Direct

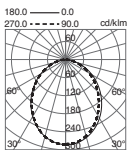
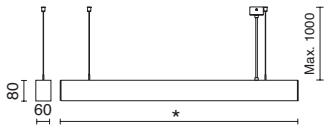

Acabado blanco, negro o gris – White, black or grey finish



 Wall (Down) P_ 138	 Ceiling P_ 140	 Recessed P_ 142	 Recessed Trimless P_ 144	 Pendant Dir/Indir. P_ 148
--	--	---	--	--

FENIX



Pendant Direct

 FENIX
Pend. Dir.
LED SMD

 CRI – °K
CRI – °K

 Potencia
Power

 Voltaje
Voltage

 Óptica
Light beam

 Regulación
Dimming

 Acabado
Finish

1061A-L	● CRI80 2700°K 30	11,65W 12	AC110-240V A	108° A	ON-OFF 0	□ Bl. / Wh. -01
1061B-L	○ CRI80 3000°K 31	17,50W 18			DALI D	■ Ng. / Blk. -02
1061C-L	○ CRI80 4000°K 33	23,30W 24				■ Gris / Grey -03
1061D-L	● CRI90 3000°K 39	29,15W 30				
1061E-L	○ CRI90 4000°K 40	34,95W 35				
1061F-L		40,80W 41				
1061G-L		46,60W 47				

Ref. 1 0 6 1 - L - - - - - A A - - -

Medidas disponibles según potencias... Available sizes according to power ratings

	1061A-	1061B-	1061C-	1061D-	1061E-	1061F-	1061G-
*	581mm	861mm	1141mm	1431mm	1711mm	1991mm	2271mm
	11,65W (12)	17,50W (18)	23,30W (24)	29,15W (30)	34,95W (35)	40,80W (41)	46,60W (47)
CR80 2700K (30)	1905lm	2855lm	3810lm	4760lm	5715lm	6665lm	7620lm
CR80 3000K (31)	1960lm	2940lm	3920lm	4900lm	5880lm	6860lm	7840lm
CR80 4000K (33)	2070lm	3105lm	4140lm	5175lm	6210lm	7245lm	8280lm
CR90 3000K (39)	1670lm	2505lm	3340lm	4175lm	5010lm	5845lm	6680lm
CR90 4000K (40)	1745lm	2620lm	3490lm	4365lm	5235lm	6110lm	6980lm

 Acc.
Codo
LED SMD

 CRI – °K
CRI – °K

 Potencia
Power

 Voltaje
Voltage

 Óptica
Light beam

 Regulación
Dimming

 Acabado
Finish

B61A-L	● CRI80 2700°K 30	5,84W 06	AC110-240V A	108° A	ON-OFF 0	□ Bl. / Wh. -01
	○ CRI80 3000°K 31		AC220-240V B		DALI D	■ Ng. / Blk. -02
	○ CRI80 4000°K 33					■ Gris / Grey -03
	● CRI90 3000°K 39					
	○ CRI90 4000°K 40					

Ref. B 6 1 A - L 0 6 A - - -

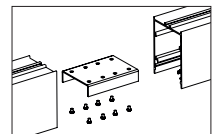

Unión línea continua – Continuous line connection

A58E-1061-41

ACER

FENIX

 Pendant Direct/Indirect

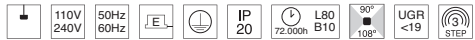



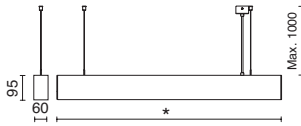

Acabado blanco, negro o gris – White, black or grey finish

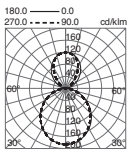

Incluye 2 grapas para la suspensión
Includes 2 clips for suspension



 Wall (Down) P_ 138	 Ceiling P_ 140	 Recessed P_ 142	 Recessed Trimless P_ 144	 Pendant Dir P_ 146
--	--	---	--	---

FENIX



Pendant Direct/Indirect

FENIX
Pend. Dir.
LED SMD

CRI – °K
CRI – °K

Potencia
Power

Voltaje
Voltage

Óptica
Light beam

Regulación
Dimming

Acabado
Finish

1064A-L	● CRI80 2700°K 30	23,3W 23	AC110-240V A	108° A	ON-OFF 0	□ Bl. / Wh. -01	
1064B-L	● CRI80 3000°K 31	35W 35			DALI D	■ Ng. / Blk. -02	
1064C-L	○ CRI80 4000°K 33	46,6W 47				■ Gris / Grey -03	
1064D-L	● CRI90 3000°K 39	58,3W 58					
1064E-L	○ CRI90 4000°K 40	70W 70					
1064F-L		81,6W 82					
1064G-L		93,3W 93					

Ref. 1 0 6 4 - L A A -

Medidas disponibles según potencias... Available sizes according to power ratings

	1064A-	1064B-	1064C-	1064D-	1064E-	1064F-	1064G-
*	591mm	871mm	1157mm	1437mm	1717mm	1979mm	2259mm
	23,3W (23)	35W (35)	46,6W (47)	58,3W (58)	70W (70)	81,6W (82)	93,3W (93)
CR80 2700K (30)	3810lm	5710lm	7620lm	9520lm	11430lm	13330lm	15240lm
CR80 3000K (31)	3920lm	5880lm	7840lm	9800lm	11760lm	13720lm	15680lm
CR80 4000K (33)	4140lm	6210lm	8280lm	10350lm	12420lm	14490lm	16560lm
CR90 3000K (39)	3340lm	5010lm	6680lm	8350lm	10020lm	11690lm	13360lm
CR90 4000K (40)	3490lm	5240lm	6980lm	8730lm	10470lm	12220lm	13960lm



Acc.
Codo
LED SMD

CRI – °K
CRI – °K

Potencia
Power

Voltaje
Voltage

Óptica
Light beam

Regulación
Dimming

Acabado
Finish

B64A-L	● CRI80 2700°K 30	5,84W 06	AC110-240V A	108° A	ON-OFF 0	□ Bl. / Wh. -01	
	● CRI80 3000°K 31		AC220-240V B		DALI D	■ Ng. / Blk. -02	
	○ CRI80 4000°K 33					■ Gris / Grey -03	
	● CRI90 3000°K 39						
	○ CRI90 4000°K 40						

Ref. B 6 4 A - L 0 6 A -



Unión línea continua – Continuous line connection

A58C-808-4I



SIGMA

 Recessed



ALU + PC  

Acabado blanco o gris – White or grey finish



Bajo pedido
On request 

Con Driver remoto
With Remote Driver









SIGMA

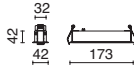
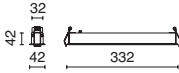
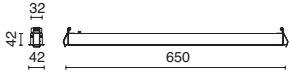

 Recessed

SIGMA Recessed	LED SMD	°K	Potencia Power	Voltaje Voltage	Óptica Light beam	Regulación Dimming	Acabado Finish	Reflector Reflector
809C-L		2700°K	38 6W 06	AC220-240V B	48° 4	ON-OFF 0	<input type="checkbox"/> Bl. / Wh -01	<input type="checkbox"/> Bl. / Wh. -01
809D-L		3000°K	39 11W 13			CASAMBI M	<input type="checkbox"/> Grs/Gry -03	<input type="checkbox"/> Ng. / Blk. -02
809E-L		4000°K	40 25W 25			DALI D		

Ref. **8 0 9 - L**  **B 4 - - -**

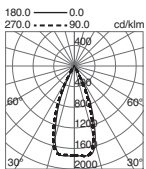
809C-	809D-	809E-
6W	11W	25W
2700K 772lm 3000K 811lm 4000K 849lm	2700K 1544lm 3000K 1622lm 4000K 1698lm	2700K 3088lm 3000K 3244lm 4000K 3396lm
6 MOD. 	12 MOD. 	24 MOD. 
 42 32 42 173	 42 32 42 332	 42 32 42 650
 166x34	 325x34	 643x34



Recessed Trimless  P_152	Pendant  P_524
---	--

SIGMA

Recessed
 Trimless

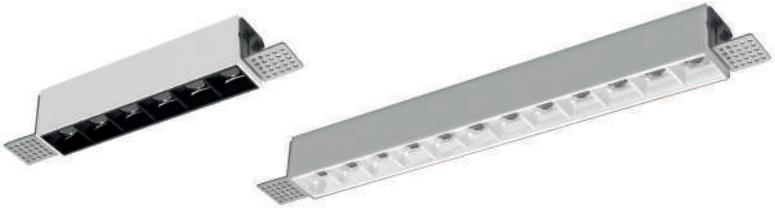

ALU + PC 

220V 240V AC
 50Hz 60Hz
  IP 20
 L80 B20
 48°
 CRI >90
 UGR <19
 STEP

Acabado blanco o gris – White or grey finish

Bajo pedido On request  34°

Con Driver remoto With Remote Driver

Sistema Trimless – Trimless system

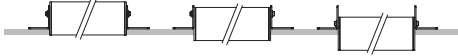

Max. 20 mm

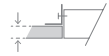

SIGMA



SIGMA	LED SMD	°K	Potencia Power	Voltaje Voltage	Óptica Light beam	Regulación Dimming	Acabado Finish	Reflector Reflector
809F-L	●	2700°K	38 6W 06	AC220-240V B	48° 4	ON-OFF 0	□ Bl. / Wh -01	□ Bl. / Wh. -01
809G-L	○	3000°K	39 11W 13			CASAMBI M	■ Grs/Gry -03	■ Ng. / Blk. -02
809H-L	○	4000°K	40 25W 25			DALI D		

Ref. **8 0 9 - L** **B 4** - - -

809F-	809G-	809H-
6W	11W	25W
2700K 772lm 3000K 811lm 4000K 849lm	2700K 1544lm 3000K 1622lm 4000K 1698lm	2700K 3088lm 3000K 3244lm 4000K 3396lm
6 MOD. □□□□□□	12 MOD. □□□□□□□□□□	24 MOD. □□□□□□□□□□□□□□□□
32 225	40 32 385	32 700
166x34	325x34	643x34

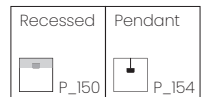
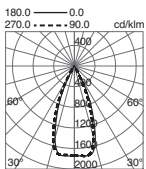

SIGMA

 Pendant Direct



ALU + PC 



220V
240V
AC

50Hz
60Hz

JEL

IP 20

80,000h

L80
B20

48°

CRI >90

UGR <19



Acabado blanco o gris – White or grey finish

Bajo pedido
On request 

Con Driver remoto
With Remote Driver





SIGMA

 Pendant Direct

SIGMA Recessed LED SMD	°K °K	Potencia Power	Voltaje Voltage	Óptica Light beam	Regulación Dimming	Acabado Finish	Reflector Reflector
809A-L	● 2700°K ○ 3000°K ○ 4000°K	38 44W 44	AC220-240V B	48° 4	ON-OFF 0 DALI D	□ Bl. / Wh -01 ■ Grs./Gry -03	□ Bl. / Wh. -01 ■ Ng. / Blk. -02

Ref. **8 0 9 - L** **B 4** - -

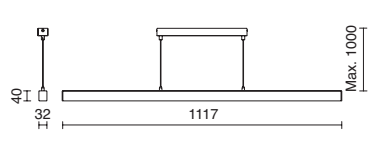
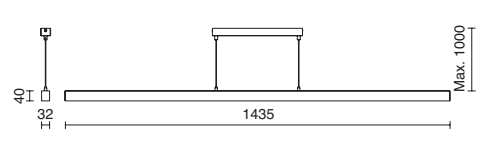
809A-	809B-
44W	57W
2700K 5404lm 3000K 5677lm 4000K 5943lm	2700K 6948lm 3000K 7299lm 4000K 7641lm
42 MOD. 	54 MOD. 
 <p>40 I 32 H 1117 Max. 1000</p>	 <p>40 I 32 H 1435 Max. 1000</p>

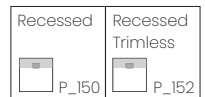
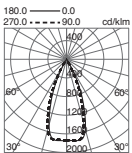

Spotlights_

UKU

Uku es una nueva serie de proyectores esféricos, versátiles y con 6 variantes en función de su instalación: empotrados a techo, para carril, de superficie en techo, para superficie en pared, de superficie en techo, suspendidos o suspendidos para carril. Cada modelo ofrece 4 diseños diferentes de difusores/ópticas: opal half, short round half, long round half y cylindrical half. Disponibles con CRI90, K Select (2700K, 3000K, 4000K), y W Select (6/9W), aseguran adaptabilidad y calidad lumínica. Su brazo articulado permite inclinaciones de 0, 15, 30, y 45°, facilitando una iluminación precisa. Estética refinada en acabados blanco, negro, y embellecedores adicionales en blanco, negro y dorado para ciertas versiones, brindando una solución de iluminación elegante y funcional para múltiples espacios.

Uku is our new series of versatile spherical projectors, with 6 variants depending on their installation: recessed to ceiling, for rail, surface-mounted on wall, surface-mounted on ceiling, suspended or suspended for rail. Each model offers 4 different designs of diffusers—optics: opal half, short round half, long round half, and cylindrical half. Available with CRI90, K Select (2700K, 3000K, 4000K), and W Select (6/9W), ensuring adaptability and lighting quality. Its articulated arm allows inclinations of 0, 15, 30, and 45°, facilitating precise lighting. Refined aesthetics in white, black finishes, and additional embellishments in white, black, and gold for certain versions, providing an elegant and functional lighting solution for multiple spaces.



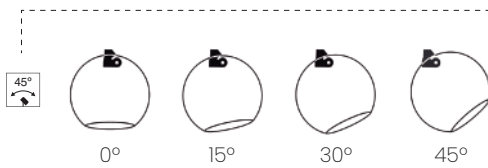

Módulo óptico intercambiable con sistema F-Connect.
Interchangeable optical module with F-Connect system.



Refrigeración del controlador
Driver Cooling



K SELECT	● 2700°K	○ 3000°K	○ 4000°K	
	6W	656lm	663lm	703lm
W SELECT	9W	881lm	913lm	954lm

- ① Diseño tradicional—Traditional Design
- ② Diseño innovador—Innovative Design

Temperatura ambiente 40°C—Ambient Temperature 40°C

- (A) Aluminio fundido a presión—Die-casting Aluminum
- (B) Caja del controlador de PC—PC Driver Case
- (C) Material térmico—Thermal Material
- (D) Aluminio fundido a presión—Die-casting Aluminum

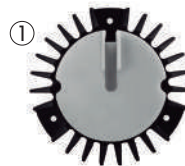

Top 114°

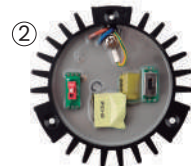
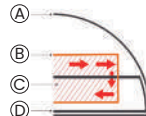

Top 68°

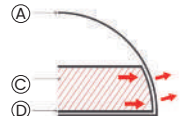

UKU

OPAL HALF

Opal half es una luminaria esférica que proporciona iluminación ambiental e iluminación general con ópticas difusoras de color blanco.

Opal half is a spherical fixture providing ambient lighting and flood lighting with milky white diffuser optics.

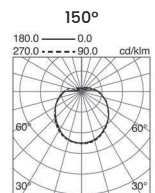

UKU

OPAL HALF



Acabado blanco o negro – White or black finish

Model	LED COB K Select	Potencia Power	Voltaje Voltage	Óptica Light beam	Regulación Dimming	Acabado Finish
UKU1 1055A-	CR190 L41	6W/9W MP	AC220-240V B	150° F	ON-OFF 0	<input type="checkbox"/> -01
UKU2 1056A-						<input checked="" type="checkbox"/> -02
UKU3 1057A-						
UKU4 1058A-						
UKU5 1059A-						
UKU6 1060A-						

Ref. A - L 4 1 M P B F 0 -

UKU1	UKU2	UKU3	UKU4	UKU5	UKU6
Recessed	Track	Wall light	Surface	Pendant	Track pendant



UKU

SHORT ROUND HALF

Short round half es una luminaria esférica de tres cuartos que puede proporcionar un ángulo de haz mínimo de 10°. Es una combinación de la óptica large&flat y el motor LED.

Short round half is a three quarter spherical fixture which can provides the minimum beam angle of 10°. It's a combination of the large&flat optics and the LED engine.

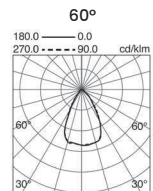
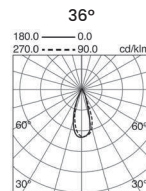
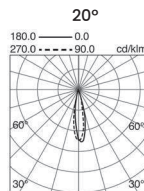
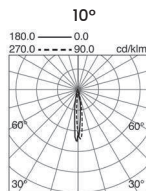

UKU

SHORT ROUND HALF

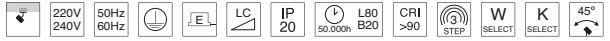

Acabado blanco o negro – White or black finish

Model	LED COB K Select	Potencia Power	Voltaje Voltage	Óptica Light beam	Regulación Dimming	Acabado Finish
UKU1 1055B-	CRI90 L41	6W/9W MP	AC220-240V B	10° 1	ON-OFF 0	<input type="checkbox"/> -01
UKU2 1056B-				20° 2		<input checked="" type="checkbox"/> -02
UKU3 1057B-				36° 3		
UKU4 1058B-				60° 6		
UKU5 1059B-						
UKU6 1060B-						

Ref. B - L 4 1 M P B 0 -

UKU1	UKU2	UKU3	UKU4	UKU5	UKU6
Recessed	Track	Wall light	Surface	Pendant	Track pendant

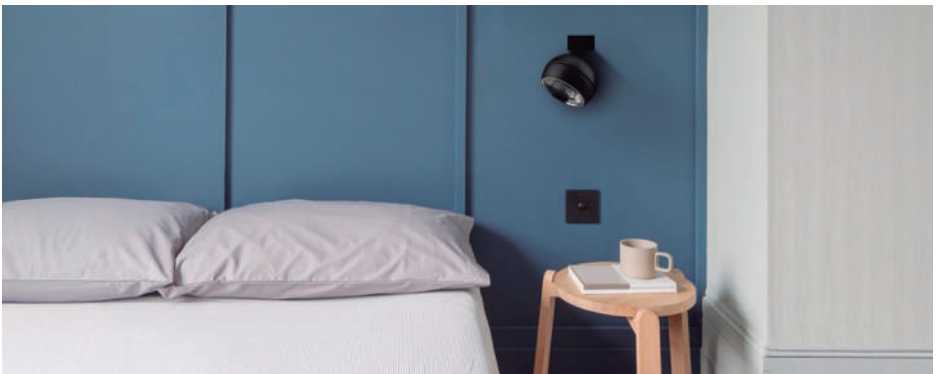

UKU

LONG ROUND HALF

Long round half es una luminaria esférica que es una combinación de la óptica semiesférica con mini reflector antideslumbrante empotrado y el motor LED.

Long round half is a spherical fixture which is a combination of the hemispherical optics with mini recessed anti-glare reflector and the LED engine.

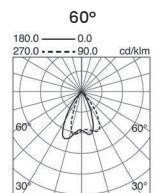
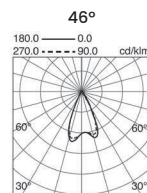
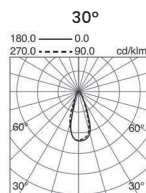
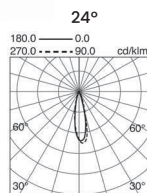

UKU

LONG ROUND HALF



Acabado blanco o negro – White or black finish

Model	LED COB K Select	Potencia Power	Voltaje Voltage	Óptica Light beam	Regulación Dimming	Acabado Finish	Embelecedor Baffle
UKU1 1055C-	CRI90 L41	6W/9W MP	AC220-240V B	24° 2	ON-OFF 0	<input type="checkbox"/> -01	<input type="checkbox"/> Bl. / Wh. -01
UKU2 1056C-				36° 3		<input type="checkbox"/> -02	<input type="checkbox"/> Ng. / Blk. -02
UKU3 1057C-				48° 4			<input type="checkbox"/> Oro/Gold -47
UKU4 1058C-				60° 6			
UKU5 1059C-							
UKU6 1060C-							

Ref. **C - L 4 1 M P B**

UKU1	UKU2	UKU3	UKU4	UKU5	UKU6
Recessed	Track	Wall light	Surface	Pendant	Track pendant



UKU

CYLINDRICAL HALF

Cylindrical half es una luminaria esférica que combina la óptica de perfil cilíndrico plano con reflector antideslumbrante y decorativo y el motor LED.

Cylindrical half is a spherical fixture which is a combination of the flat-cylinder profile optics with ant-glare and decorative reflector and the LED engine.

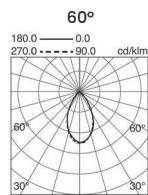
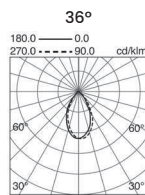
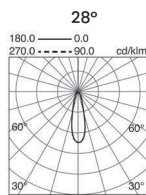
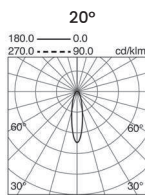

TURT



Acabado blanco con embellecedor blanco o cromado
White finish with white or chrome baffle

Con Driver remoto
With Remote Driver



TURT

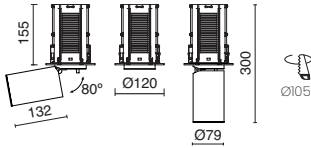

8,8W		18,6W	
CRI95		CRI95	
2700°K	1121lm	2700°K	2157lm
3000°K	1168lm	3000°K	2342lm
4000°K	1274lm	4000°K	2449lm
CRI95 FASHION		CRI95 FASHION	
3250°K	1380lm	3250°K	12389lm

Round LED COB	CRI – °K CRI – °K	Potencia Power	Voltaje Voltage	Óptica Light beam	Regulación Dimming	Acabado Aro-Embellecedor Ring-Baffle finish
1002A-L	● CRI90 2700°K	38	8,8W 10 AC110-240V A	20° 2	ON-OFF 0	□ □ Bl.+Bl. / Wh.+Wh. -01-01
	● CRI90 3000°K	39	18,6W 20 AC220-240V B	40° 4	PUSH/-10V 1	□ ■ Bl.+Crm./Wh.+Chrm -01-32
	○ CRI90 4000°K	40		55° 5	DALI D	
	○ CRI95 3250°K	51			L,C (trailing and leading edge) F CASAMBI M	

Ref. **1 0 0 2 A - L** - **0 1** -

Regulaciones disponibles según voltaje...Dimming options according to voltage

AC110-240V	PUSH/-10V	AC220-240V	ON-OFF
	DALI		L,C (trailing and leading edge)
			CASAMBI

Filtros – Filters

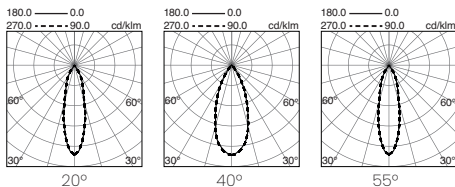
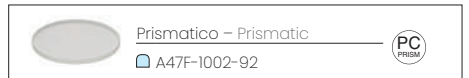
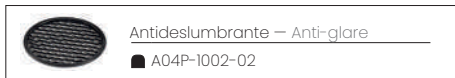

ARROW

Carril no incluido
Track not included



Acabado negro o acabado blanco con embellecedor blanco o cromado
Black finish or white finish with white or chrome baffle

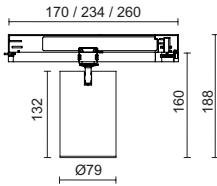

8,8W		18,6W	
CRI95		CRI95	
2700°K	1121lm	2700°K	2157lm
3000°K	1168lm	3000°K	2342lm
4000°K	1274lm	4000°K	2449lm
CRI95 FASHION		CRI95 FASHION	
3250°K	1380lm	3250°K	2389lm

Round LED COB	CRI – °K CRI – °K	Potencia Power	Voltaje Voltage	Óptica Light beam	Regulación Dimming	Acabado Aro-Embellecedor Ring-Baffle finish
1003A-L	● CRI90 2700°K 38	8,8W 10	AC220-240V B	20° 2	ON-OFF 0	<input type="checkbox"/> Bl.+Bl. / Wh.+Wh. -01-01
	○ CRI90 3000°K 39	18,6W 20		40° 4	DALI D	<input type="checkbox"/> Bl.+Crm./Wh.+Chrm -01-32
	○ CRI90 4000°K 40			55° 5	CASAMBI M	<input checked="" type="checkbox"/> Ng.+Ng/Blck+Blck. -02-02
	○ CRI95 3250°K 51					

Ref. **1 0 0 3 A - L** **B** - -

Regulaciones disponibles según potencia...Regulations available according to power

8,8W	ON-OFF	18,6W	ON-OFF
			DALI
			CASAMBI

Filtros – Filters

	Antideslumbrante – Anti-glare ■ A04P-1002-02
	Prismatico – Prismatic ■ A47F-1002-92



-01-01

-01-32

-02-02

ARROW

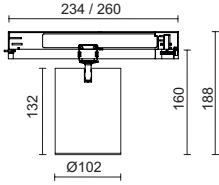

24W

CRI82
2000°K **2349lm**
MEAT

CRI92
4000°K **3402lm**
FISH

CRI88
2500°K **3169lm**
BREAD

CRI96
3000°K **2896lm**
VEG.+FRUIT

27,4W

CRI95
2700°K **3140lm**
3000°K **3254lm**
4000°K **3570lm**

CRI95 *FASHION*
3250°K **3194lm**

Round LED COB	CRI – °K CRI – °K	Potencia Power Power	Voltaje Voltage Voltage	Óptica Light beam Light beam	Regulación Dimming Dimming	Acabado Aro-Embellecedor Ring-Baffle finish	
1003B-L	CRI90 2700°K 38	24W 24	AC220-240V B	20° 2	ON-OFF 0	<input type="checkbox"/> Bl.+Bl. / Wh.+Wh. -01-01	
	CRI90 3000°K 39					<input type="checkbox"/> Bl.+Crm./Wh.+Chrm -01-32	
	CRI90 4000°K 40	27,4W 30	AC220-240V B	40° 4	DALI D	<input type="checkbox"/> Ng.+Ng/Blck.+Blck. -02-02	
	CRI82 2000°K 44						
	CRI88 2500°K 46						
	CRI92 4000°K 47				55° 5	CASAMBI M	
	CRI96 3000°K 48						
CRI95 3250°K 51							

Ref. **1 0 0 3 B - L** **B**

CRI & CCT disponibles según potencia_CRI & CCT available according to power

24W	27,4W	27,4W
CRI82 2000°K	CRI90 2700°K	CRI95 3250°K (<i>FASHION</i>)
CRI88 2500°K	CRI90 3000°K	
CRI92 4000°K	CRI90 4000°K	
CRI96 3000°K		

Filtros – Filters

Antideslumbrante – Anti-glare
 A04P-1003-02

Prismatic – Prismatic
 A47G-1003-92

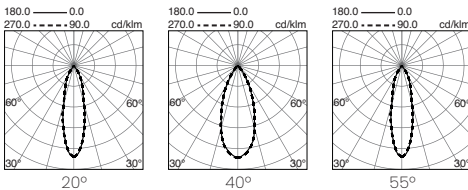

Carril – Track
P_ 278-281

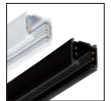

DUBE

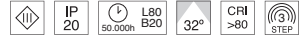

Acabado blanco o negro – White or black finish

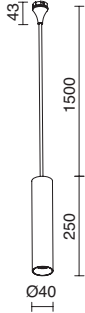

Añadir bases
Add bases (P_147)

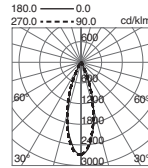

796B-L3110I

h (m)	d (m)	E (lux)
1,00	0,57	1913
2,00	1,14	478
3,00	1,71	213
4,00	2,28	120
5,00	2,85	77

LED COB 9,2W 1250lm 3000K

- 796B-L3110I-01
- 796B-L3110I-02



Añadir bases
Add bases (P_147)

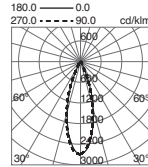

796A-L3110I

h (m)	d (m)	E (lux)
1,00	0,57	1913
2,00	1,14	478
3,00	1,71	213
4,00	2,28	120
5,00	2,85	77

LED COB 9,2W 1250lm 3000K

- 796A-L3110I-01
- 796A-L3110I-02



Accesorios – Accessories

 Filtro suavizante Softener filter A47D-796-92	 Filtro extensivo Extensive filter A47E-796-92	 Filtro elongador Extension filter A47C-796-92	 Rejilla antideslumbrante Anti-glare grille A04M-796-02
 Embellecedor antideslumbrante – Anti-glare baffle A55A-796-02 A55A-796-45 A55A-796-46			
		 796A-L3110I-01 A55A-796-45 A47C-796-92	 796A-L3110I-02 A55A-796-46 A04M-796-02

DUBE

(BASES – BASIS)



ALU

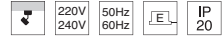

Acabado blanco o negro – White or black finish

B19G-, con Driver remoto
B19G-, with Remote Driver



ON-OFF (10W) *

- B19G-X3315A-01
- B19G-X3315A-02

L.C (Inicio y fin – Start and end) 10W

- B19G-X33RFB-01
- B19G-X33RFB-02



1-10V (10W)

- B19G-X33RIB-01
- B19G-X33RIB-02

DALI (10W)

- B19G-X33RDB-01
- B19G-X33RDB-02

CASAMBI (10W)

- B19G-X33RMB-01
- B19G-X33RMB-02

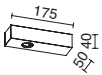

L175 (10W)

- B19A-X3310B-01
- B19A-X3310B-02

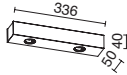

L336 (20W)

- B19B-X3340B-01
- B19B-X3340B-02



L560 (30W)

- B19C-X3330B-01
- B19C-X3330B-02



Ø100 (10W)

- B19E-X3310B-01
- B19E-X3310B-02



Ø260 (30W)

- B19F-X3330B-01
- B19F-X3330B-02

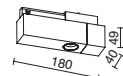
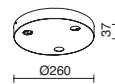

10W

- B19H-X3310B-01
- B19H-X3310B-02



Carril – Track
P_ 278-281

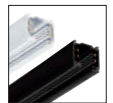

DUBE

Combinaciones – Combinations



B19C-X3330B-02
796A-L3110I-02
2x 796B-L3110I-01



B19G-X3315A-01
796A-L3110I-01

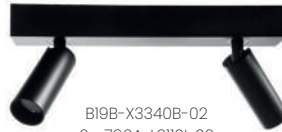

B19B-X3340B-02
2x 796A-L3110I-02



B28A-X33X2B-02
B19H-X3310B-02
796B-L3110I-02



B19G-X33RFB-02
796A-L3110I-02



B28A-X33X2B-01
B19H-X3310B-01
796A-L3110I-01



B19F-X3330B-01
3x 796B-L3110I-01



HIDRA



Acabado blanco o negro con embellecedores blanco, negro u oro
White or black finish with white, black or gold trims

	2700K	2361lm
	3000K	2572lm
	4000K	2441lm

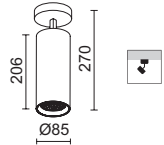

LED COB 25W

- 835C-L4I25B2F-01-01
- 835C-L4I25B2F-01-02
- 835C-L4I25B2F-01-47
- 835C-L4I25B2F-02-02
- 835C-L4I25B2F-02-47



LED COB 25W

- 835C-L4I25B3F-01-01
- 835C-L4I25B3F-01-02
- 835C-L4I25B3F-01-47
- 835C-L4I25B3F-02-02
- 835C-L4I25B3F-02-47



LED COB 25W

- 835C-L4I25B6F-01-01
- 835C-L4I25B6F-01-02
- 835C-L4I25B6F-01-47
- 835C-L4I25B6F-02-02
- 835C-L4I25B6F-02-47

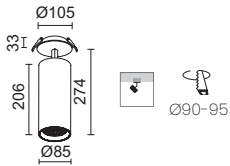

LED COB 25W

- 835D-L4I25B2F-01-01
- 835D-L4I25B2F-01-02
- 835D-L4I25B2F-01-47
- 835D-L4I25B2F-02-02
- 835D-L4I25B2F-02-47



LED COB 25W

- 835D-L4I25B3F-01-01
- 835D-L4I25B3F-01-02
- 835D-L4I25B3F-01-47
- 835D-L4I25B3F-02-02
- 835D-L4I25B3F-02-47



LED COB 25W

- 835D-L4I25B6F-01-01
- 835D-L4I25B6F-01-02
- 835D-L4I25B6F-01-47
- 835D-L4I25B6F-02-02
- 835D-L4I25B6F-02-47

Rejilla antideslumbrante - Anti-glare grille

- A04R-835.20.01
- A04R-835.20.02
- A04R-835.20.47

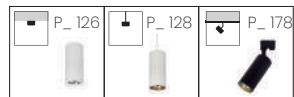



HIDRA

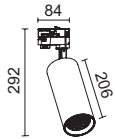

Carril no incluido
Track not included

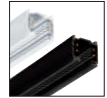

Carril – Track
P_ 278-281



Acabado blanco o negro con embellecedores blanco, negro u oro
White or black finish with white, black or gold trims

K SELECT	2700K	2361lm
	3000K	2572lm
	4000K	2441lm



LED COB 25W

- 835A-L4125B2F-01-01
- 835A-L4125B2F-01-02
- 835A-L4125B2F-01-47
- 835A-L4125B2F-02-02
- 835A-L4125B2F-02-47



LED COB 25W

- 835A-L4125B3F-01-01
- 835A-L4125B3F-01-02
- 835A-L4125B3F-01-47
- 835A-L4125B3F-02-02
- 835A-L4125B3F-02-47



LED COB 25W

- 835A-L4125B6F-01-01
- 835A-L4125B6F-01-02
- 835A-L4125B6F-01-47
- 835A-L4125B6F-02-02
- 835A-L4125B6F-02-47

Rejilla antideslumbrante - Anti-glare grille

- A04R-835.20.01
- A04R-835.20.02
- A04R-835.20.47





FALL



ALU PC TRANS 110V 240V 50Hz 60Hz IP 20 50.000h L80 B20 60x90° CRI >82 STEP W SELECT K SELECT 90° 350°

Acabado blanco o negro – White or black finish

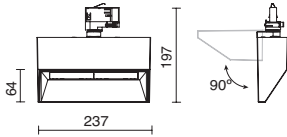

LED SMD 30W / 40W / 50W

983A-L4IMPA-01

983A-L4IMPA-02



Adaptador para techo – Adapter for ceiling

B25-X33X2B-01

B25-X33X2B-02



Combinaciones – Combinations		
50W	3000K	5375lm
	3500K	5890lm
	4000K	5859lm
40W	3000K	4362lm
	3500K	4754lm
	4000K	4771lm
30W	3000K	3560lm
	3500K	3846lm
	4000K	3908lm

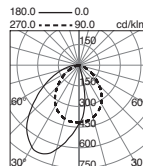
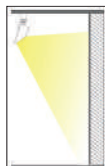

Carril – Track
P_ 278-281





ENIGMA



Carril no incluido
Track not included

ALU GLASS PRISM PC FACET METAL 220V 240V 50Hz 60Hz IP 20 50000h L80 B20 15°-60° CRI >90 STEP K SELECT 90° 355°

Acabado blanco o negro – White or black finish

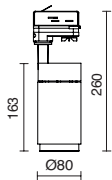

	15°	60°
<input type="checkbox"/> K SELECT	2700K 1158lm	2061lm
	3000K 1280lm	2285lm
	4000K 1224lm	2182lm

LED COB 25W

803B-L4125B6F-01

803B-L4125B6F-02

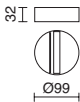

Adaptador para techo – Adapter for ceiling

B25-X33X2B-01

B25-X33X2B-02

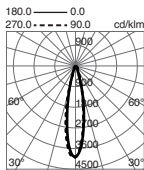

2700K

h (m)	d (m)	E (lux)
1,00	0,35	4700
2,00	0,70	522
3,00	1,05	522
4,00	1,40	294
5,00	1,75	188

3000K

h (m)	d (m)	E (lux)
1,00	0,35	5308
2,00	0,70	590
3,00	1,05	590
4,00	1,40	332
5,00	1,75	212

4000K

h (m)	d (m)	E (lux)
1,00	0,35	5153
2,00	0,70	573
3,00	1,05	573
4,00	1,40	322
5,00	1,75	206

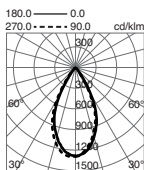
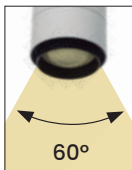

2700K

h (m)	d (m)	E (lux)
1,00	0,93	2654
2,00	1,86	295
3,00	2,79	295
4,00	3,72	166
5,00	4,65	106

3000K

h (m)	d (m)	E (lux)
1,00	0,93	2971
2,00	1,86	330
3,00	2,79	330
4,00	3,72	186
5,00	4,65	119

4000K

h (m)	d (m)	E (lux)
1,00	0,93	2867
2,00	1,86	319
3,00	2,79	319
4,00	3,72	179
5,00	4,65	115

Carril – Track
P_ 278-281



ENIGMA



Carril no incluido
Track not included



Acabado blanco o negro – White or black finish

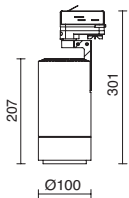

LED COB 35W 1570lm (10°)-3270lm (60°) **3000K**

LED COB 35W 1790lm (10°)-3720lm (60°) **4000K**

□ 803A-L3135B-01

□ 803A-L3335B-01

■ 803A-L3135B-02

■ 803A-L3335B-02

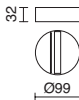

Adaptador para techo – Adapter for ceiling

□ B25-X33X2B-01

■ B25-X33X2B-02

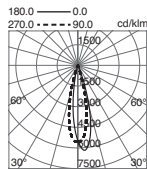
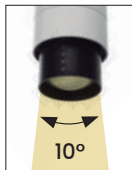

3000K

h (m)	d (m)	E (lux)
1,00	0,21	21818
2,00	0,42	5455
3,00	0,63	2424
4,00	0,84	1364
5,00	1,05	873

4000K

h (m)	d (m)	E (lux)
1,00	0,21	23602
2,00	0,42	5901
3,00	0,63	2622
4,00	0,84	1475
5,00	1,05	944

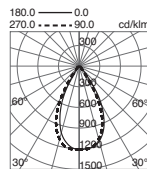
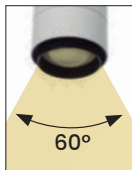

3000K

h (m)	d (m)	E (lux)
1,00	1,15	4595
2,00	2,30	1149
3,00	3,45	511
4,00	4,60	287
5,00	5,75	184

4000K

h (m)	d (m)	E (lux)
1,00	1,15	4941
2,00	2,30	1235
3,00	3,45	549
4,00	4,60	309
5,00	5,75	198

Carril – Track
P_ 278-281



HAITI



Acabado blanco, negro o gris – White, black or grey finish

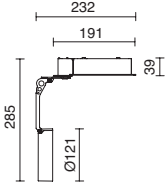

3000K

LED COB 17W 2180lm

- 772L-L3125B-01
- 772L-L3125B-02
- 772L-L3125B-03

- 772L-L31RDB-01
- 772L-L31RDB-02
- 772L-L31RDB-03

LED COB 17W 2210lm

- 772M-L3125B-01
- 772M-L3125B-02
- 772M-L3125B-03

- 772M-L31RDB-01
- 772M-L31RDB-02
- 772M-L31RDB-03

4000K

LED COB 17W 2250lm

- 772L-L3325B-01
- 772L-L3325B-02
- 772L-L3325B-03

- 772L-L33RDB-01
- 772L-L33RDB-02
- 772L-L33RDB-03

LED COB 17W 2280lm

- 772M-L3325B-01
- 772M-L3325B-02
- 772M-L3325B-03

- 772M-L33RDB-01
- 772M-L33RDB-02
- 772M-L33RDB-03



Filtros de conversión para pescado, marisco, verdura, carne o pan
Conversion for fish, seafood, vegetables, meat or bread

	SEAFOOD	A14A-738-00	for 3000K
	VEG+FRUIT	A14A-738-00	
	FISH	A14A-738-00	for 4000K
	MEAT	A14B-738-00	
	BREAD	A14C-738-00	

Porta filtros – Support for filters

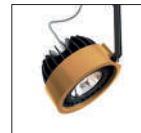
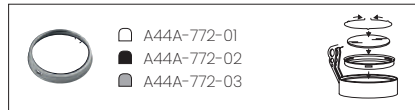

Aro customizable
Customizable ring

HAITI RANGE EXTENSION UPDATED



Acabado blanco, negro o gris – White, black or grey finish

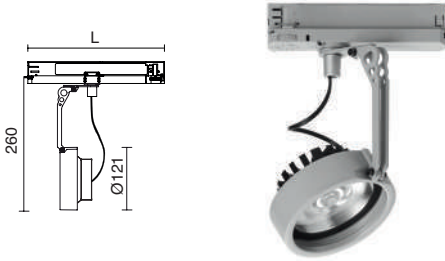

3000K

LED COB 17W 2180lm

- U □ 772Q-L3117B10-01
- U ■ 772Q-L3117B10-02
- U ▒ 772Q-L3117B10-03

- E □ 772Q-L3117B1D-01
- E ■ 772Q-L3117B1D-02
- E ▒ 772Q-L3117B1D-03

- 772Q-L3117B1M-01
- 772Q-L3117B1M-02
- ▒ 772Q-L3117B1M-03

LED COB 17W 2210lm

- U □ 772R-L3117B20-01
- U ■ 772R-L3117B20-02
- U ▒ 772R-L3117B20-03

- E □ 772R-L3117B2D-01
- E ■ 772R-L3117B2D-02
- E ▒ 772R-L3117B2D-03

- 772R-L3117B2M-01
- 772R-L3117B2M-02
- ▒ 772R-L3117B2M-03

4000K

LED COB 17W 2250lm

- U □ 772Q-L3317B10-01
- U ■ 772Q-L3317B10-02
- U ▒ 772Q-L3317B10-03

- E □ 772Q-L3317B1D-01
- E ■ 772Q-L3317B1D-02
- E ▒ 772Q-L3317B1D-03

- 772Q-L3317B1M-01
- 772Q-L3317B1M-02
- ▒ 772Q-L3317B1M-03

LED COB 17W 2280lm

- U □ 772R-L3317B20-01
- U ■ 772R-L3317B20-02
- U ▒ 772R-L3317B20-03

- E □ 772R-L3317B2D-01
- E ■ 772R-L3317B2D-02
- E ▒ 772R-L3317B2D-03

- 772R-L3317B2M-01
- 772R-L3317B2M-02
- ▒ 772R-L3317B2M-03

L = 234 mm



L = 253 mm



L = 170 mm



L = 234 mm



L = 253 mm



L = 170 mm



Filtros de conversión para pescado, marisco, verdura, carne o pan
Conversion filters for fish, seafood, vegetables, meat or bread

	SEAFOOD	A14A-738-00	for 3000K
	VEG+FRUIT	A14A-738-00	
	FISH	A14A-738-00	for 4000K
	MEAT	A14B-738-00	
	BREAD	A14C-738-00	

Porta filtros – Support for filters

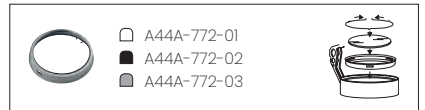

Carril – Track
P_ 278-281

CRETE 1

48V DC



Acabado blanco o negro – White or black finish

Con Driver remoto
With Remote Driver

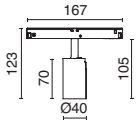

Round LED COB	CRI – °K CRI – °K	Potencia Power	Voltaje Voltage	Óptica Light beam	Regulación Dimming	Acabado Finish
1032A-L	● CRI90 2700°K 38	6,6W 07	48V V	20° 2	ON-OFF 0	□ Bl. / Wh. -01
	● CRI90 3000°K 39			35° 3	DALI D	■ Ng. / Blk. -02
	○ CRI90 4000°K 40					

Ref. **1 0 3 2 A - L 0 7 V -**

UGR según la óptica UGR according light beam	
20°	UGR6
35°	UGR9

PVP según regulación
PVP according regulations

ON-OFF _____
DALI _____

Carril 48V – 48V Track P_ 194-201

Driver 48V P_863



CRETE 1

48V DC



Acabado blanco o negro – White or black finish

Con Driver remoto
With Remote Driver

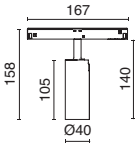

Round LED COB	CRI – °K CRI – °K	Potencia Power	Voltaje Voltage	Óptica Light beam	Regulación Dimming	Acabado Finish
1032B-L	● CRI90 2700°K 38	11W 11	48V V	18° 1	ON-OFF 0	□ Bl. / Wh. -01
	○ CRI90 3000°K 39			25° 2	DALI D	■ Ng. / Blk. -02
	○ CRI90 4000°K 40			33° 3		

Ref. **1 0 3 2 B - L 1 1 V -**

UGR según la óptica UGR according light beam	
18°	UGR18
25°	UGR10
33°	UGR19

PVP según regulación
PVP according regulations

ON-OFF
DALI

Carril 48V – 48V Track P_ 194-201

Driver 48V P_863



CRETE 1

48V DC



Acabado blanco o negro – White or black finish

Con Driver remoto
With Remote Driver

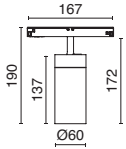

Round LED COB	CRI – °K CRI – °K	Potencia Power	Voltaje Voltage	Óptica Light beam	Regulación Dimming	Acabado Finish
1032C-L	● CRI90 2700°K 38	18,1W 18	48V V	20° 2	ON-OFF 0	□ Bl. / Wh. -01
	○ CRI90 3000°K 39			36° 3	DALI D	■ Ng. / Blk. -02
	○ CRI90 4000°K 40					

Ref. **1 0 3 2 C - L** **1 8 V** -

UGR según la óptica UGR according light beam	
20°	UGR8
36°	UGR12

PVP según regulación
PVP according regulations

ON-OFF _____
DALI _____

Carril 48V – 48V Track P_ 194-201

Driver 48V P_863



CRETE 1

48V DC



Acabado blanco o negro – White or black finish

Con Driver remoto
With Remote Driver

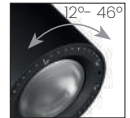
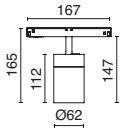

Round LED COB	CRI – °K	Potencia Power	Voltaje Voltage	Óptica Light beam	Regulación Dimming	Acabado Finish
1032D-L	● CRI90 2700°K 38	12,9W 13	48V V	12°-46 V	ON-OFF 0	<input type="checkbox"/> Bl. / Wh. -01
	○ CRI90 3000°K 39				DALI D	<input checked="" type="checkbox"/> Ng. / Blk. -02
	○ CRI90 4000°K 40					

Ref. **1 0 3 2 D - L 1 3 V V -**

PVP según regulación
PVP according regulations

ON-OFF _____

DALI _____

Carril 48V – 48V Track P_ 194-201

Driver 48V P_863



CRETE 2

48V DC

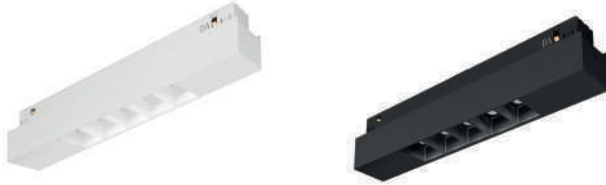

ALU



Acabado blanco o negro – White or black finish

Con Driver remoto
With Remote Driver

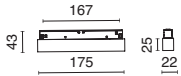

Round LED COB	CRI – °K CRI – °K	Potencia Power	Voltaje Voltage	Óptica Light beam	Regulación Dimming	Acabado Finish
1038A-L	● CRI90 2700°K 38	7,5W 08	48V V	16° 1	ON-OFF 0	□ Bl. / Wh. -01
	○ CRI90 3000°K 39			36° 3	DALI D	■ Ng. / Blk. -02
	○ CRI90 4000°K 40			50° 5		

Ref. **1 0 3 8 A - L 0 8 V -**

PVP según regulación
PVP according regulations

ON-OFF _____
DALI _____

UGR según la óptica UGR according light beam	
16°	UGR6
36°	UGR20
50°	UGR10

Carril 48V – 48V Track P_ 194-201

Driver 48V P_863



CRETE 2

48V DC



ALU

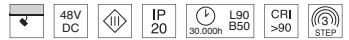

Acabado blanco o negro – White or black finish

Con Driver remoto
With Remote Driver

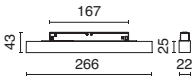

Round LED COB	CRI – °K CRI – °K	Potencia Power	Voltaje Voltage	Óptica Light beam	Regulación Dimming	Acabado Finish
1038B-L	● CRI90 2700°K 38	15W 15	48V V	16° 1	ON-OFF 0	□ Bl. / Wh. -01
	○ CRI90 3000°K 39			36° 3	DALI D	■ Ng. / Blk. -02
	○ CRI90 4000°K 40			50° 5		

Ref. **1 0 3 8 B - L** **1 5 V** -

PVP según regulación
PVP according regulations

ON-OFF _____
DALI _____

UGR según la óptica UGR according light beam		
16°	UGR6	
36°	UGR20	
50°	UGR10	

Carril 48V – 48V Track P_ 194-201

Driver 48V P_863



CRETE 2

48V DC



Acabado blanco o negro – White or black finish

Con Driver remoto
With Remote Driver

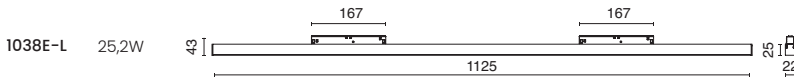
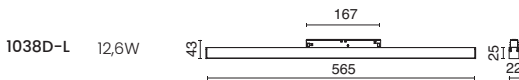
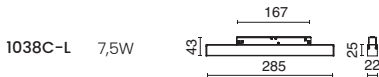

Round LED COB	CRI – °K	Potencia Power	Voltaje Voltage	Óptica Light beam	Regulación Dimming	Acabado Finish
1038C-L	● CRI90 2700°K	38 7,5W 08	48V V	16° 1	ON-OFF 0	□ Bl. / Wh. -01
1038D-L	○ CRI90 3000°K	39 12,6W 13		36° 3	DALI D	■ Ng. / Blk -02
1038E-L	○ CRI90 4000°K	40 25,2W 25		50° 5		

Ref. 1 0 3 8 A - L 0 8 V -

PVP según regulación-PVP according regulations

L285 L565 L1125

ON-OFF

DALI

UGR según la óptica UGR according light beam	
16°	UGR6
36°	UGR20
50°	UGR10



Carril 48V – 48V Track P_ 194-201

Driver 48V P_863



TRACK 48V



ALU



48V
DC



IP
20

Acabado blanco o negro – White or black finish



1m	2m	3m
□ B32A-X33X2V-01	□ B32B-X33X2V-01	□ B32C-X33X2V-01
■ B32A-X33X2V-02	■ B32B-X33X2V-02	■ B32C-X33X2V-02

DRIVERS 48V

	REF.	OUT				IN		SIZES	IP
		V	C	220-240V	110-127V	V	Freq.		
	B02V-X3375V-00	48V DC	-	75W	-	220-240 V AC	50/60 Hz	180x52x30	20
	B02V-X33J5V-00	48V DC	-	120W	-	220-240 V AC	50/60 Hz	300x40x30	20
	B32N-X33A1V-01	48V DC	-	100W	-	220-240 V AC	50/60 Hz	207,5x16x19	20
	B32N-X33A1V-02								
	B32N-X33A6V-01	48V DC	-	250W	-	220-240 V AC	50/60 Hz	268x22x43,5	20
	B32N-X33A6V-02								

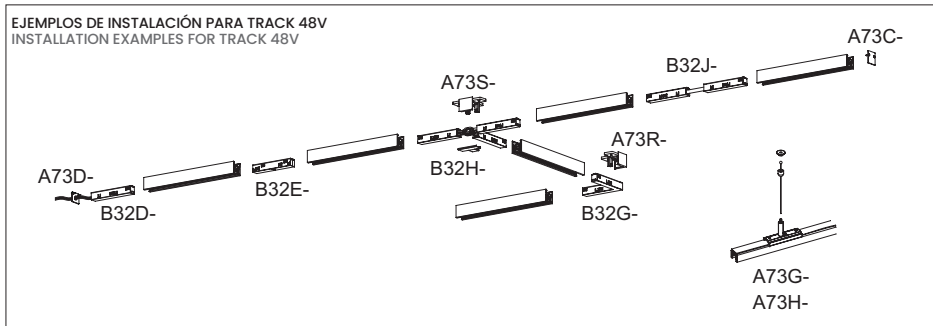

Accesorios – Accessories

Caja de conexión
Box connection

- B32K-X33X2V-01
- B32K-X33X2V-02



Kit suspension cable acero
Suspension kit w/steel cable

- A73G-1032-38

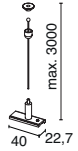

Fuente de alimentación superficie
Surface power supply

- B32L-X33AIV-01
- B32L-X33AIV-02

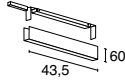

230Vac/48Vdc
100W

Kit suspension uniones cable acero
Suspension kit for junctions w/steel cable

- A73H-1032-38

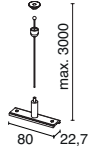

Fuente de alimentación suspensión
Power supply for suspension

- B32M-X33AIV-01
- B32M-X33AIV-02



230Vac/48Vdc
100W

Herramienta de corte conductores
Cutting tool for conductors

- A73U-1032-01



Tapa final
Dead end

- A73C-1032-01
- A73C-1032-02



Unión mecánica en "L"
Mechanical "L" junction

- A73R-1032-01
- A73R-1032-02

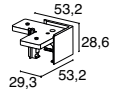

Tapa final con agujero
End cap with hole

- A73D-1032-01
- A73D-1032-02

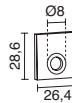

Unión mecánica en "T"
Mechanical "T" junction

- A73S-1032-01
- A73S-1032-02

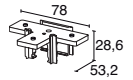

Alimentación final
Live end

- B32D-X33X2V-01
- B32D-X33X2V-02



Codo con contactos
90° junction with contacts

- B32G-X33X2V-01
- B32G-X33X2V-02



Unión con contacto
Electrical straight coupling

- B32E-X33X2V-01
- B32E-X33X2V-02



Unión en "T" con contactos
"T" coupling with contacts

- B32H-X33X2V-01
- B32H-X33X2V-02

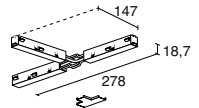

Unión sin contacto
Straight coupling w/o contacts

- B32F-X33X2V-01
- B32F-X33X2V-02



Codo flexible con contactos
Flexible junction with contacts

- B32J-X33X2V-01
- B32J-X33X2V-02



TRACK 48V



ALU



Acabado blanco o negro – White or black finish

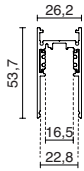

1m

- B34A-X33X2V-01
- B34A-X33X2V-02

2m

- B34B-X33X2V-01
- B34B-X33X2V-02

3m

- B34C-X33X2V-01
- B34C-X33X2V-02

DRIVERS 48V

	REF.	OUT				IN		SIZES	IP
		V	C	220-240V	110-127V	V	Freq.		
	B02V-X3375V-00	48V DC	-	75W	-	220-240 V AC	50/60 Hz	180x52x30	20
	B02V-X33J5V-00	48V DC	-	120W	-	220-240 V AC	50/60 Hz	300x40x30	20
	B32N-X33A1V-01	48V DC	-	100W	-	220-240 V AC	50/60 Hz	207,5x16x19	20
	B32N-X33A1V-02								
	B32N-X33A6V-01	48V DC	-	250W	-	220-240 V AC	50/60 Hz	268x22x43,5	20
	B32N-X33A6V-02								

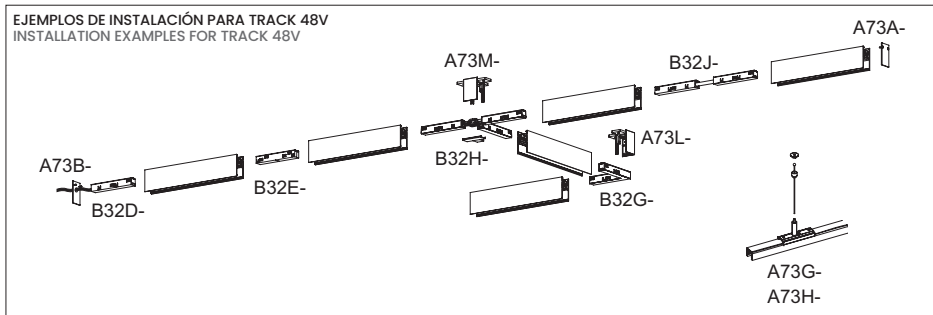

Accesorios — Accessories

Caja de conexión
Box connection

- B32K-X33X2V-01
- B32K-X33X2V-02



Kit suspension cable acero
Suspension kit w/steel cable

- A73G-1032-38

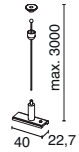

Fuente de alimentación superficie
Surface power supply

- B32L-X33AIV-01
- B32L-X33AIV-02

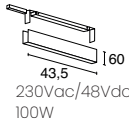

Kit suspension uniones cable acero
Suspension kit for junctions w/steel cable

- A73H-1032-38

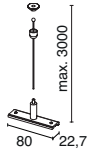

Fuente de alimentación suspensión
Power supply for suspension

- B32M-X33AIV-01
- B32M-X33AIV-02

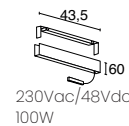

Herramienta de corte conductores
Cutting tool for conductors

- A73U-1032-01



Tapa final
Dead end

- A73A-1032-01
- A73A-1032-02



Unión mecánica en "L"
Mechanical "L" junction

- A73L-1032-01
- A73L-1032-02

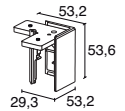

Tapa final con agujero
End cap with hole

- A73B-1032-01
- A73B-1032-02

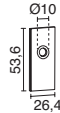

Unión mecánica en "T"
Mechanical "T" junction

- A73M-1032-01
- A73M-1032-02

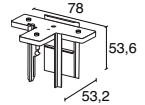

Tapa frontal
Dead end

- A73T-1032-01
- A73T-1032-02



Codo con contactos
90° junction with contacts

- B32G-X33X2V-01
- B32G-X33X2V-02

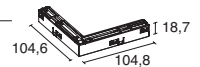

Alimentación final
Live end

- B32D-X33X2V-01
- B32D-X33X2V-02

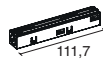

Unión en "T" con contactos
"T" coupling with contacts

- B32H-X33X2V-01
- B32H-X33X2V-02

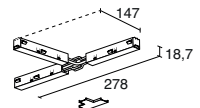

Unión con contacto
Electrical straight coupling

- B32E-X33X2V-01
- B32E-X33X2V-02

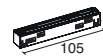

Codo flexible con contactos
Flexible junction with contacts

- B32J-X33X2V-01
- B32J-X33X2V-02



Unión sin contacto
Straight coupling w/o contacts

- B32F-X33X2V-01
- B32F-X33X2V-02

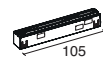

TRACK 48V



ALU



48V
DC



IP
20

Acabado blanco o negro – White or black finish

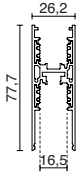

1m

2m

3m

- B33A-X33X2V-01
- B33A-X33X2V-02

- B33B-X33X2V-01
- B33B-X33X2V-02

- B33C-X33X2V-01
- B33C-X33X2V-02

DRIVERS 48V

	REF.	OUT				IN		SIZES	IP
		V	C	220-240V	110-127V	V	Freq.		
	B02V-X3375V-00	48V DC	-	75W	-	220-240 V AC	50/60 Hz	180x52x30	20
	B02V-X3315V-00	48V DC	-	120W	-	220-240 V AC	50/60 Hz	300x40x30	20
	B32N-X33A1V-01	48V DC	-	100W	-	220-240 V AC	50/60 Hz	207,5x16x19	20
	B32N-X33A1V-02								
	B32N-X33A6V-01	48V DC	-	250W	-	220-240 V AC	50/60 Hz	268x22x43,5	20
	B32N-X33A6V-02								

EJEMPLOS DE INSTALACIÓN PARA TRACK 48V INSTALLATION EXAMPLES FOR TRACK 48V

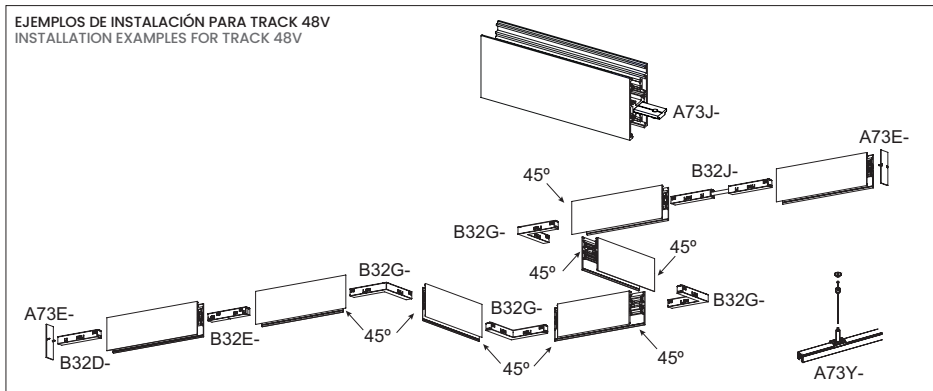

Accesorios – Accessories

Caja de conexión
Box connection

- B32K-X33X2V-01
- B32K-X33X2V-02



Kit suspension cable acero
Suspension kit w/ steel cable

- A73Y-1032-38

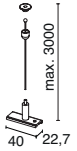

Fuente de alimentación suspensión
Power supply for suspension

- B32M-X33AIV-01
- B32M-X33AIV-02



230Vac/48Vdc
100W

Herramienta de corte conductores
Cutting tool for conductors

- A73U-1032-01



Tapa final
End cap

- A73E-1032-01
- A73E-1032-02

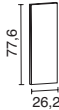

Pletina de unión
Joint plates

- A73J-1032-01
- A73J-1032-02

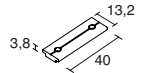

Tapa frontal
Front cover

- A73T-1032-01
- A73T-1032-02



Codo con contactos
90° junction with contacts

- B32G-X33X2V-01
- B32G-X33X2V-02

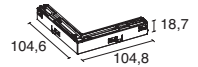

Alimentación final
End Power Supply

- B32D-X33X2V-01
- B32D-X33X2V-02



Codo flexible con contactos
Flexible junction with contacts

- B32J-X33X2V-01
- B32J-X33X2V-02

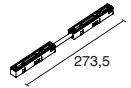

Unión con contacto
Electrical straight coupling

- B32E-X33X2V-01
- B32E-X33X2V-02



Unión sin contacto
Straight coupling w/o contacts

- B32F-X33X2V-01
- B32F-X33X2V-02

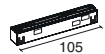

TRACK 48V

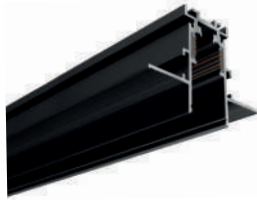

ALU

48V DC IP 20

Acabado blanco o negro – White or black finish

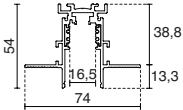

1m

2m

3m

B35A-X33X2V-01

B35B-X33X2V-01

B35C-X33X2V-01

B35A-X33X2V-02

B35B-X33X2V-02

B35C-X33X2V-02

DRIVERS 48V

	REF.	OUT				IN		SIZES	IP
		V	C	220-240V	110-127V	V	Freq.		
	B02V-X3375V-00	48V DC	-	75W	-	220-240 V AC	50/60 Hz	180x52x30	20
	B02V-X33J5V-00	48V DC	-	120W	-	220-240 V AC	50/60 Hz	300x40x30	20
	B32N-X33AIV-01	48V DC	-	100W	-	220-240 V AC	50/60 Hz	207,5x16x19	20
	B32N-X33AIV-02								
	B32N-X33A6V-01	48V DC	-	250W	-	220-240 V AC	50/60 Hz	268x22x43,5	20
	B32N-X33A6V-02								

EJEMPLOS DE INSTALACIÓN PARA TRACK 48V INSTALLATION EXAMPLES FOR TRACK 48V

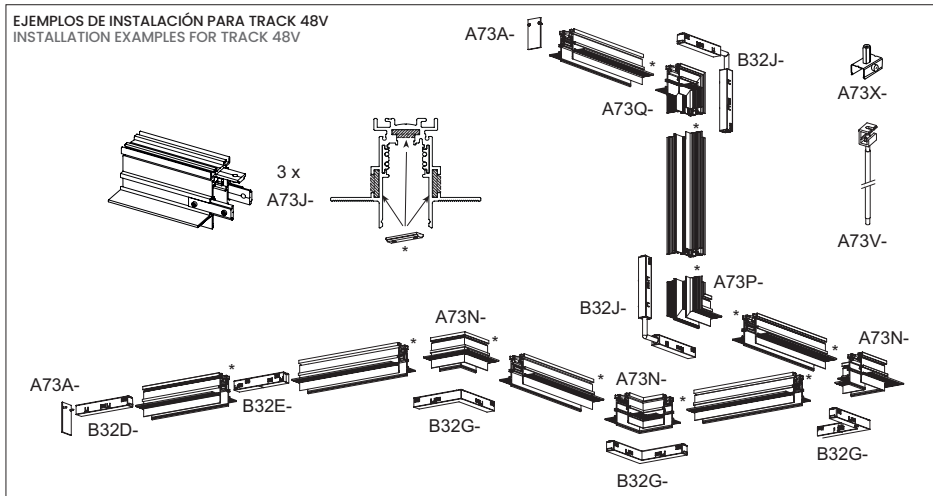

Accesorios – Accessories

Codo horizontal trimless
90° horizontal trimless junction

- A73N-1032-01
- A73N-1032-02

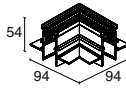

Kit suspension cable acero
Suspension kit w/ steel cable

- A73V-1032-39

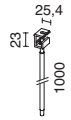

Codo vertical externo trimless
90° external trimless junction

- A73P-1032-01
- A73P-1032-02



Grapa fijación M6
M6x1m clam

- A73X-1032-38

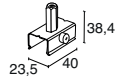

Codo vertical interno trimless
90° internal trimless junction

- A73Q-1032-01
- A73Q-1032-02



Herramienta de corte conductores
Cutting tool for conductors

- A73U-1032-01



Plantilla
Template

- A73F-1032-38



Pletina de unión
Joint plates

- A73J-1032-01
- A73J-1032-02

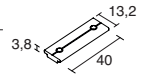

Tapa final
End cap

- A73A-1032-01
- A73A-1032-02



Tapa final con agujero
End cap with hole

- A73B-1032-01
- A73B-1032-02

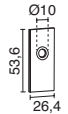

Alimentación final
End Power Supply

- B32D-X33X2V-01
- B32D-X33X2V-02



Codo con contactos
90° junction with contacts

- B32G-X33X2V-01
- B32G-X33X2V-02



Unión con contacto
Electrical straight coupling

- B32E-X33X2V-01
- B32E-X33X2V-02



Codo flexible con contactos
Flexible junction with contacts

- B32J-X33X2V-01
- B32J-X33X2V-02



Unión sin contacto
Straight coupling w/o contacts



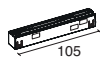























































- B32F-X33X2V-01
- B32F-X33X2V-02



Tapa frontal
Front cover

- A73T-1032-01
- A73T-1032-02



Familia Family	Pag.	IP	LED/m	Potencia Power	CRI	CCT	Medidas Measures
NILO 5	210-211	IP20 IP67	 	8,5W/m 14,4W/m	CRI>90	 2700°K  3000°K  4000°K	5mm 7mm 
NILO 8-10	206-209	IP20 IP67	   	4,8W/m 9,6W/m 14,4W/m 19,2W/m	CRI>80 CRI>90	 2700°K  3000°K  4000°K	8mm 10mm 12mm 
NILO BASIC	204-205	IP20 IP67		12,6W/m	CRI>80	 2700°K  3000°K  4000°K	8mm 10mm 
NILO DUAL	215	IP20		13,5W/m	CRI>80	 2700°K  6000°K 	10mm 
NILO EFFICIENCY	216-217	IP20 IP67	 	11W/m 22W/m	CRI>80	 2700°K  3000°K  4000°K	10mm 12mm 14mm 
NILO RGB	212-213	IP20 IP67	 	7,2W/m 14,4W/m	-		10mm 12mm 
NILO RGB+W	214	IP20 IP67		5,5W/m	-	  2700°K  3000°K  4000°K	10mm 12mm 
RINS	218-219	IP20 IP67	NO DOT	10W/m 14W/m	CRI>90	 2700°K  3000°K  4000°K	8mm 10mm 
SENA	220	IP65	NO DOT	12,7W/m	CRI>80	 2700°K  3000°K  4000°K 	10mm 
SENA RGB	221	IP65	NO DOT	12,7W/m	-	 	10mm 
VOLGA	222-223	IP65	 	12W/m 18W/m	CRI>80	 2700°K  3000°K  4000°K	12mm 15mm 

Led Strips_

NILO BASIC

IP 20



Recomendaciones de uso e instalación – Recommendations for use and installation (P_872)

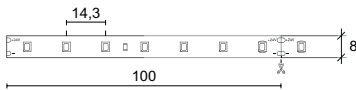

12,6W/m 1248lm/m **2700K**

201AS-L3012FC0-00

12,6W/m 1344lm/m **3000K**

201AS-L3112FC0-00

12,6W/m 1360lm/m **4000K**

201AS-L3312FC0-00



Conector tira-cable
Cable strip connector
CONAS-B03A-KIT

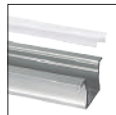

Perfiles
Profiles
P_224



Alimentadores
Power supplies
P_239



Conector tira-tira
Strip-strip connector
CONAS-B03B-KIT



Controladores
Controllers
P_231

NILO BASIC

IP 67

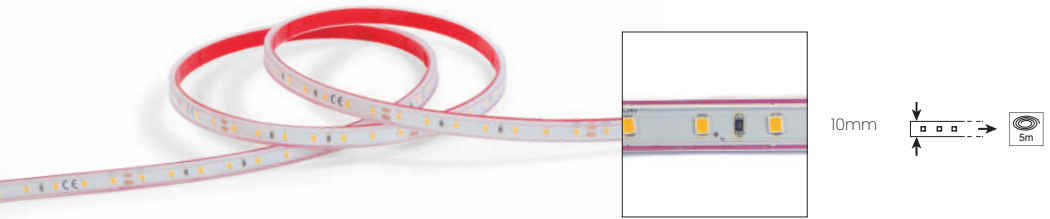

Recomendaciones de uso e instalación – Recommendations for use and installation (P_872)

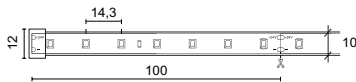

12,6W/m 1234lm/m **2700K**

20IDS-L3012FC0-00

12,6W/m 1329lm/m **3000K**

20IDS-L3112FC0-00

12,6W/m 1345lm/m **4000K**

20IDS-L3312FC0-00



Conector tira-cable
Cable strip connector
CONDS-B03A-KIT

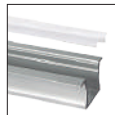

Perfiles
Profiles
P_224



Alimentadores
Power supplies
P_239



Conector tira-tira
Strip-strip connector
CONDS-B03B-KIT



Controladores
Controllers
P_231

NILO 8-10

IP 20

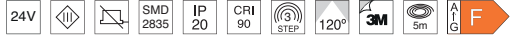

Recomendaciones de uso e instalación – Recommendations for use and installation (P_872)

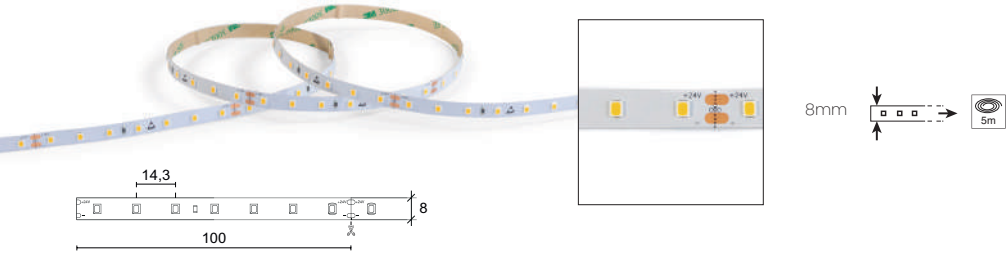

4,8W/m 505lm/m **2700K**

200AS-L3805FC0-00

4,8W/m 530lm/m **3000K**

200AS-L3905FC0-00

4,8W/m 580lm/m **4000K**

200AS-L4005FC0-00

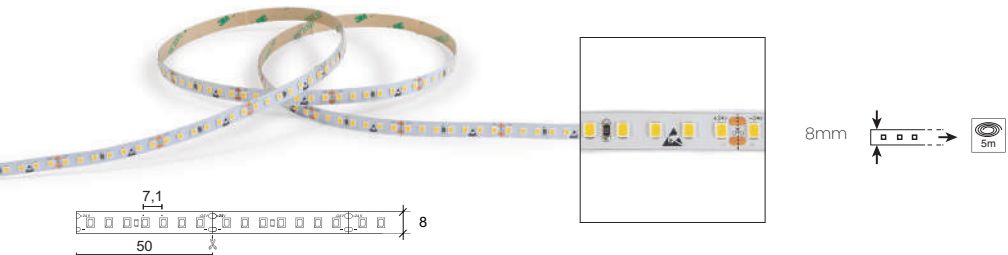

9,6W/m 979lm/m **2700K**

200AS-L3810FC0-00

9,6W/m 1060lm/m **3000K**

200AS-L3910FC0-00

9,6W/m 1150lm/m **4000K**

200AS-L4010FC0-00



Conector tira-cable
Cable strip connector

CONAS-B03A-KIT

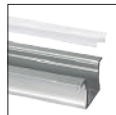

Perfiles
Profiles

P_224



Alimentadores
Power supplies

P_239

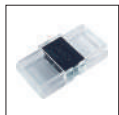

Conector tira-tira
Strip-strip connector

CONAS-B03B-KIT



Controladores
Controllers

P_231

NILO 8-10

IP 20



Recomendaciones de uso e instalación – Recommendations for use and installation (P_872)

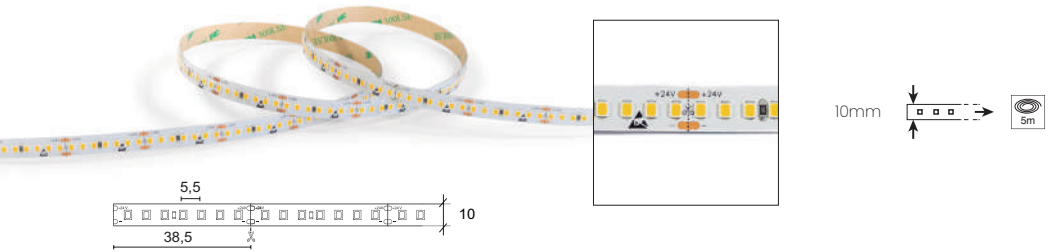

14,4W/m 1510lm/m **2700K**

200AS-L3814FC0-00

14,4W/m 1585lm/m **3000K**

200AS-L3914FC0-00

14,4W/m 1730lm/m **4000K**

200AS-L4014FC0-00

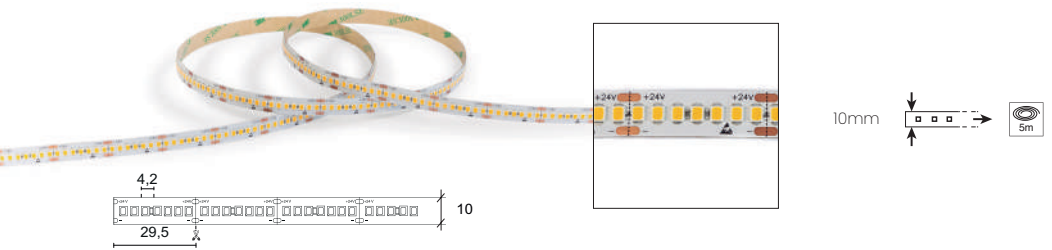

19,2W/m 2020lm/m **2700K**

200AS-L3819FC0-00

19,2W/m 2110lm/m **3000K**

200AS-L3919FC0-00

19,2W/m 2300lm/m **4000K**

200AS-L4019FC0-00



Conector tira-cable
Cable strip connector
CONAS-B03A-KIT

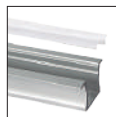

Perfiles
Profiles
P_224



Alimentadores
Power supplies
P_239



Conector tira-tira
Strip-strip connector
CONAS-B03B-KIT



Controladores
Controllers
P_231

NILO 8-10

IP 67

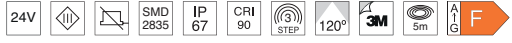

Recomendaciones de uso e instalación – Recommendations for use and installation (P_872)

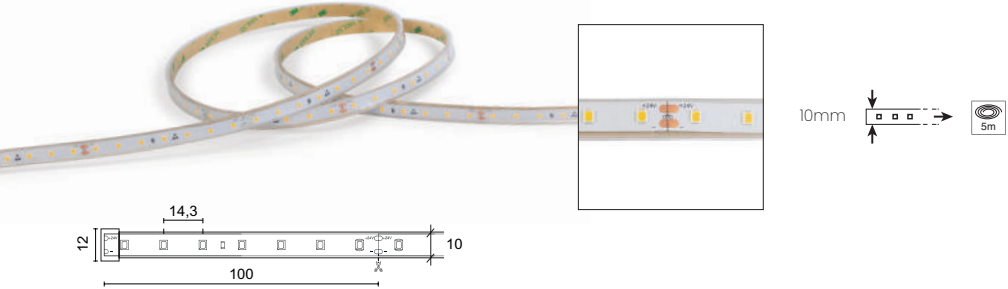

4,8W/m 490lm/m **2700K**

200DS-L3805FC0-00

4,8W/m 510lm/m **3000K**

200DS-L3905FC0-00

4,8W/m 550lm/m **4000K**

200DS-L4005FC0-00

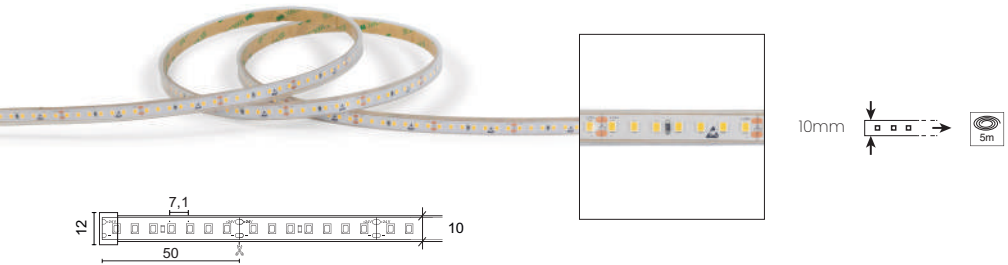

9,6W/m 979/m **2700K**

200DS-L3810FC0-00

9,6W/m 1010lm/m **3000K**

200DS-L3910FC0-00

9,6W/m 1100lm/m **4000K**

200DS-L4010FC0-00



Conector tira-cable
Cable strip connector

CONDS-B03A-KIT

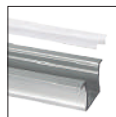

Perfiles
Profiles

P_224



Alimentadores
Power supplies

P_239



Conector tira-tira
Strip-strip connector

CONDS-B03B-KIT



Controladores
Controllers

P_231

NILO 8-10

IP 67



Recomendaciones de uso e instalación – Recommendations for use and installation (P_872)

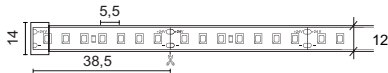

14,4W/m 1440lm/m **2700K**

200DS-L3814FC0-00

14,4W/m 1510lm/m **3000K**

200DS-L3914FC0-00

14,4W/m 1645lm/m **4000K**

200DS-L4014FC0-00

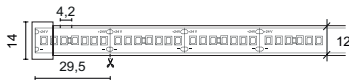
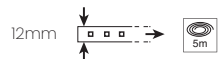
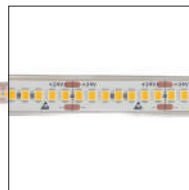

19,2W/m 1920lm/m **2700K**

200DS-L3819FC0-00

19,2W/m 2010lm/m **3000K**

200DS-L3919FC0-00

19,2W/m 2185lm/m **4000K**

200DS-L4019FC0-00



Conector tira-cable
Cable strip connector

CONDS-B03A-KIT

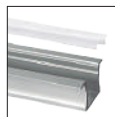

Perfiles
Profiles

P_224



Alimentadores
Power supplies

P_239



Conector tira-tira
Strip-strip connector

CONDS-B03B-KIT



Controladores
Controllers

P_231

NILO 5

IP 20

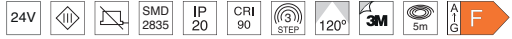

Recomendaciones de uso e instalación – Recommendations for use and installation (P_872)

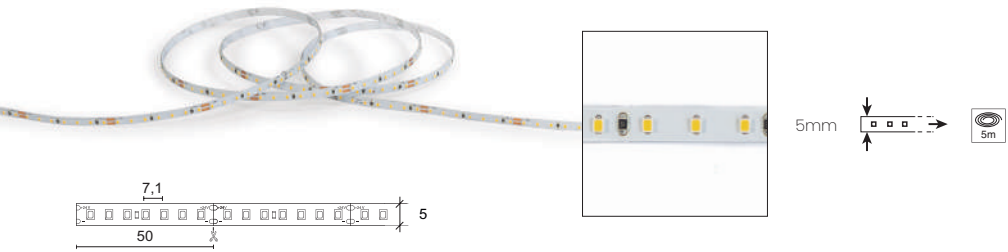

8,5W/m 950lm/m **2700K**

203AS-L3809FC0-00

8,5W/m 1000lm/m **3000K**

203AS-L3909FC0-00

8,5W/m 1030lm/m **4000K**

203AS-L4009FC0-00

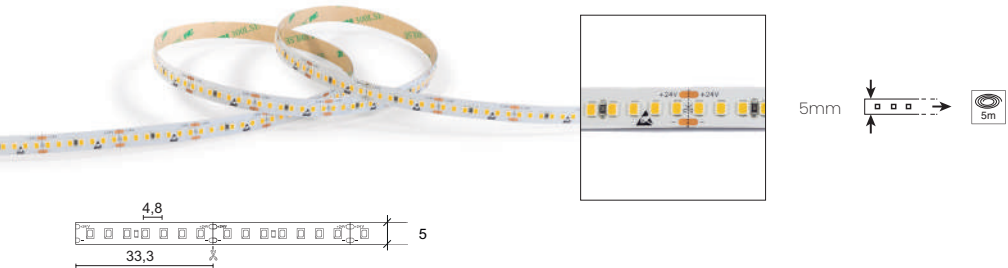

12W/m 1280lm/m **2700K**

203AS-L3814FC0-00

12W/m 1365lm/m **3000K**

203AS-L3914FC0-00

12W/m 1410lm/m **4000K**

203AS-L4014FC0-00

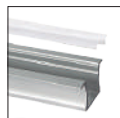

Perfiles
Profiles
P_224



Alimentadores
Power supplies
P_239



Controladores
Controllers
P_231

NILO 5

IP 67

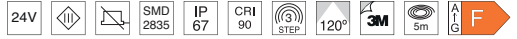

Recomendaciones de uso e instalación – Recommendations for use and installation (P_872)

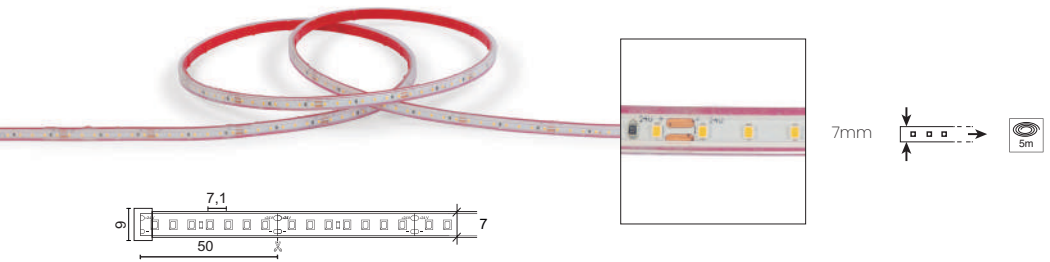

8,5W/m 920lm/m **2700K**

203DS-L3809FC0-00

8,5W/m 970lm/m **3000K**

203DS-L3909FC0-00

8,5W/m 1000lm/m **4000K**

203DS-L4009FC0-00

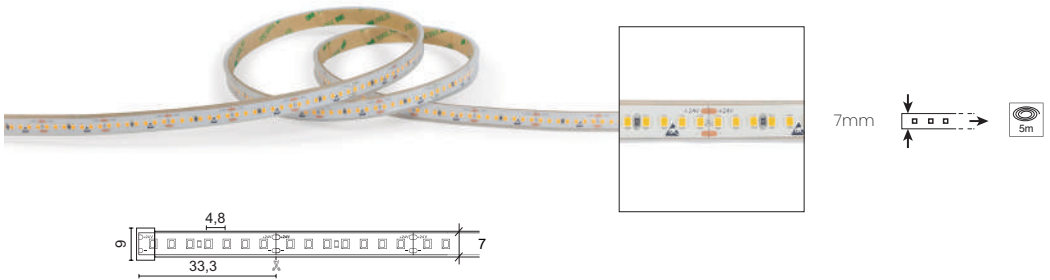

12W/m 1240lm/m **2700K**

203DS-L3814FC0-00

12W/m 1330lm/m **3000K**

203DS-L3914FC0-00

12W/m 1370lm/m **4000K**

203DS-L4014FC0-00

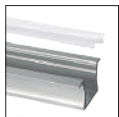

Perfiles
Profiles
P_224



Alimentadores
Power supplies
P_239



Controladores
Controllers
P_231

NILO RGB

IP 20

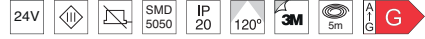

Recomendaciones de uso e instalación – Recommendations for use and installation (P_872)

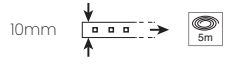
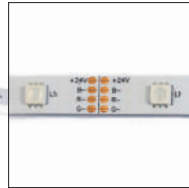

7,2W/m ● 65lm/m ● 130lm/m ● 55lm/m
200AS-L0407FC0-00

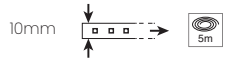
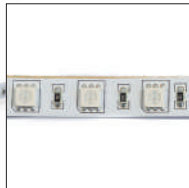
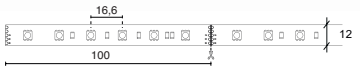

14,4W/m ● 132lm/m ● 360lm/m ● 108lm/m
200AS-L0414FC0-00

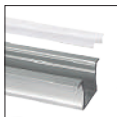

Perfiles
Profiles
P_224



Alimentadores
Power supplies
P_239



Controladores
Controllers
P_231

NILO RGB

IP 67



Recomendaciones de uso e instalación – Recommendations for use and installation (P_872)

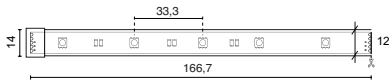
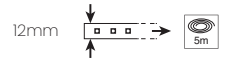

7,2W/m ● 65lm/m ● 130lm/m ● 55lm/m
200DS-L0407FC0-00

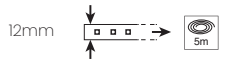

14,4W/m ● 132lm/m ● 360lm/m ● 108lm/m
200DS-L0414FC0-00

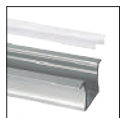

Perfiles
Profiles
P_224



Alimentadores
Power supplies
P_239



Controladores
Controllers
P_231

NILO RGB+W



IP 20 / IP 67

2700K
3000K
4000K



Recomendaciones de uso e instalación – Recommendations for use and installation (P_872)



RGB 18,2W/m 838lm/m
+ W 5,5W/m 410lm/m **2700K**

200AS-LI416FC0-00

RGB 18,2W/m 868lm/m
+ W 5,5W/m 440lm/m **3000K**

201AS-LI416FC0-00

RGB 18,2W/m 868lm/m
+ W 5,5W/m 474lm/m **4000K**

202AS-LI416FC0-00

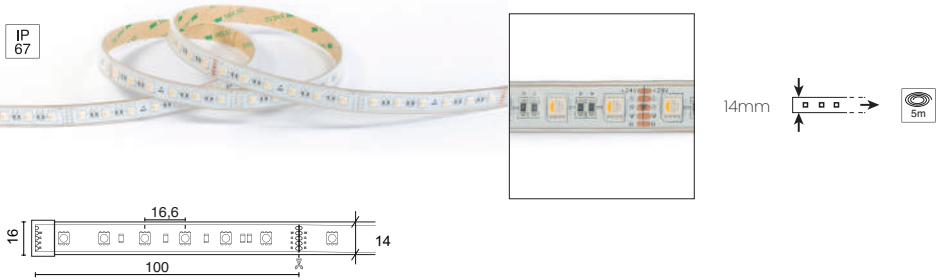

RGB 18,2W/m 838lm/m
+ W 5,5W/m 410lm/m **2700K**

200DS-LI416FC0-00

RGB 18,2W/m 868lm/m
+ W 5,5W/m 440lm/m **3000K**

201DS-LI416FC0-00

RGB 18,2W/m 868lm/m
+ W 5,5W/m 474lm/m **4000K**

202DS-LI416FC0-00

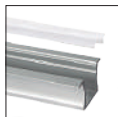

Perfiles
Profiles
P_224



Alimentadores
Power supplies
P_239



Controladores
Controllers
P_231

NILO DUAL

IP 20



Recomendaciones de uso e instalación – Recommendations for use and installation (P_872)

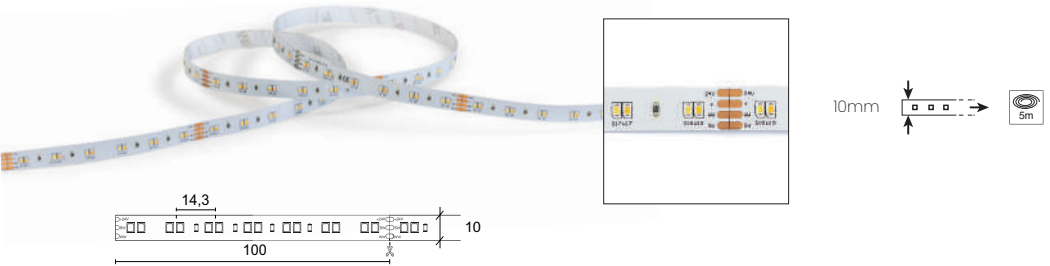

13,5W/m 700lm (2700K) 800lm (6500K)

206AS-L5213FC0-00



K SELECT Temperatura de color seleccionable entre el rango indicado.
Válida para adaptarse a nuestros ritmos biológicos (ciclo circadiano).
Selectable color temperature within the indicated range.
Valid to adapt to our biological rhythms (circadian cycle).



En este caso, la Tira Led se ubica perimétricamente dentro de los paneles.
In this case, the Led Strip is located perimeter inside the panels.

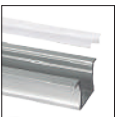

Perfiles
Profiles
P_224



Alimentadores
Power supplies
P_239



Controladores
Controllers
P_231

NILO EFFICIENCY

IP 20

2700K 3000K 4000K

Recomendaciones de uso e instalación – Recommendations for use and installation (P_872)

10mm

11W/m 1750lm/m **2700K**
204AS-L3011FC0-00

11W/m 1950lm/m **3000K**
204AS-L3111FC0-00

11W/m 2080lm/m **4000K**
204AS-L3311FC0-00

64 LED/m

12mm

22W/m 3600lm/m **2700K**
204AS-L3022FC0-00

22W/m 3700lm/m **3000K**
204AS-L3122FC0-00

22W/m 4000lm/m **4000K**
204AS-L3322FC0-00

128 LED/m

Perfiles
Profiles
P_224

Alimentadores
Power supplies
P_239

Controladores
Controllers
P_231

NILO EFFICIENCY

IP 67

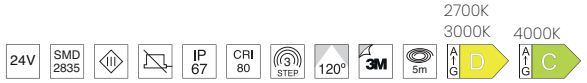

Recomendaciones de uso e instalación – Recommendations for use and installation (P_872)

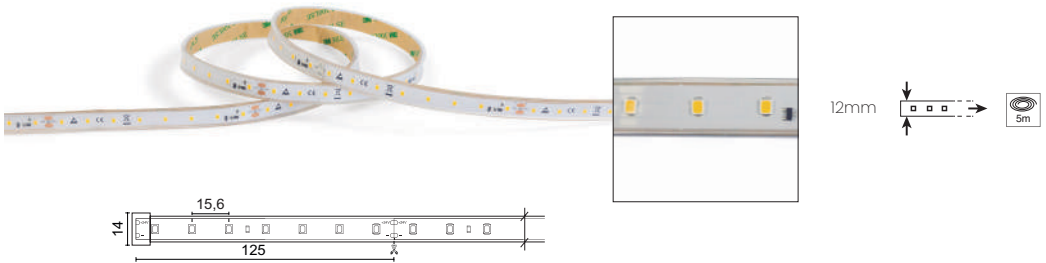

11W/m 1750lm/m **2700K**
204DS-L3011FC0-00

11W/m 1850lm/m **3000K**
204DS-L3111FC0-00

11W/m 2000lm/m **4000K**
204DS-L3311FC0-00

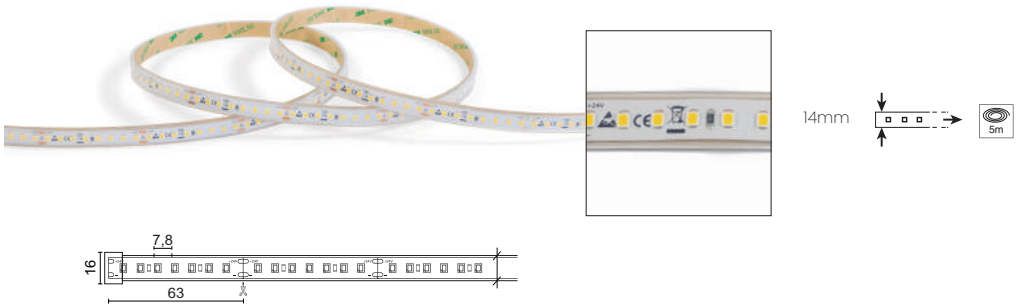

22W/m 3550lm/m **2700K**
204DS-L3022FC0-00

22W/m 3650lm/m **3000K**
204DS-L3122FC0-00

22W/m 3850lm/m **4000K**
204DS-L3322FC0-00

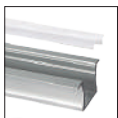

Perfiles
Profiles
P_224



Alimentadores
Power supplies
P_239



Controladores
Controllers
P_231

RINS

IP 20

2700K
3000K
4000K



Recomendaciones de uso e instalación – Recommendations for use and installation (P_872)

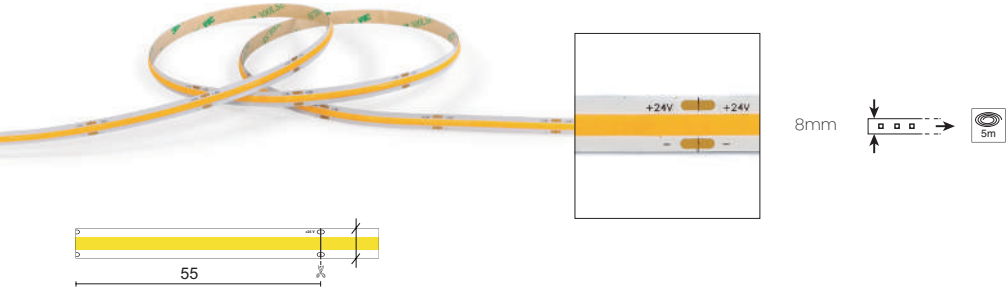

10W/m 900lm/m **2700K**
202AC-L3810FC0-00

10W/m 950lm/m **3000K**
202AC-L3910FC0-00

10W/m 1000lm/m **4000K**
202AC-L4010FC0-00

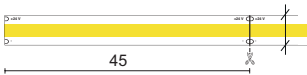

14W/m 1250lm/m **2700K**
202AC-L3814FC0-00

14W/m 1320lm/m **3000K**
202AC-L3914FC0-00

14W/m 1400lm/m **4000K**
202AC-L4014FC0-00

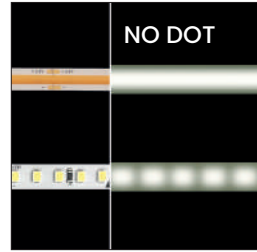

Conector tira COB-tira COB
COB strip-COB strip connector
CONAC-B03A-KIT

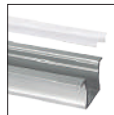

Profiles
Profiles
P_224



Alimentadores
Power supplies
P_239



Conector tira COB-tira COB
COB strip-COB strip connector
CONAC-B03B-KIT



Controladores
Controllers
P_231

RINS

IP 67

2700K
3000K
4000K



Recomendaciones de uso e instalación – Recommendations for use and installation (P_872)

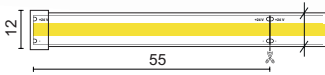

10W/m 880lm/m. **2700K**

202DC-L3810FC0-00

10W/m 930lm/m **3000K**

202DC-L3910FC0-00

10W/m 980lm/m **4000K**

202DC-L4010FC0-00

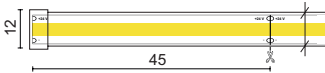

14W/m 1225lm/m **2700K**

202DC-L3814FC0-00

14W/m 1290lm/m **3000K**

202DC-L3914FC0-00

14W/m 1360lm/m **4000K**

202DC-L4014FC0-00

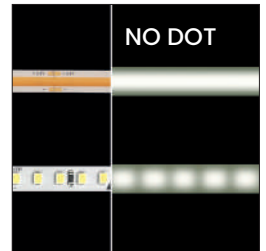

Alimentadores
Power supplies
P_239

SENA

IP 65



Recomendaciones de uso e instalación – Recommendations for use and installation (P_872)

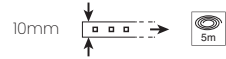
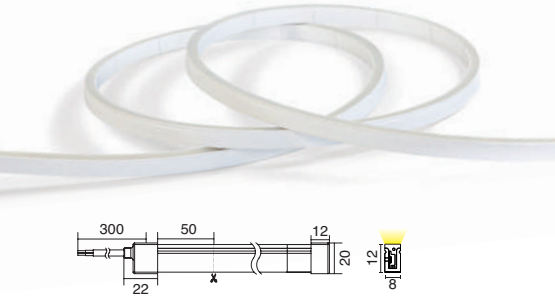

12W/m 400lm/m **2700K**
205CN-L3012FC0-00

12W/m 430lm/m **3000K**
205CN-L3112FC0-00

12W/m 450lm/m **4000K**
205CN-L3312FC0-00

140
LED/m

2 grapas de fijación/m incluidas – 2 fixing clips/m included



Grapa extra – Extra staple
GRA_205CN_8x12

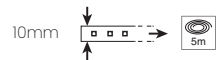
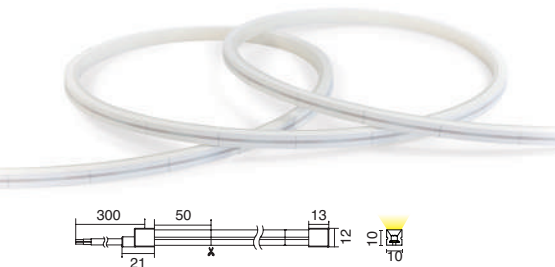
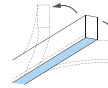

12,7W/m 950lm/m **2700K**
207CN-L3012FC0-00

12,7W/m 960lm/m **3000K**
207CN-L3112FC0-00

12,7W/m 1020lm/m **4000K**
207CN-L3312FC0-00

140
LED/m

2 grapas de fijación/m incluidas – 2 fixing clips/m included



Grapa extra – Extra staple
GRA_207CN



Accesorio – Accessory
TAP_SET.IP65.SENA207CN



**Alimentadores
Power supplies**
P_239



SENA RGB

IP 65



Recomendaciones de uso e instalación – Recommendations for use and installation (P_872)

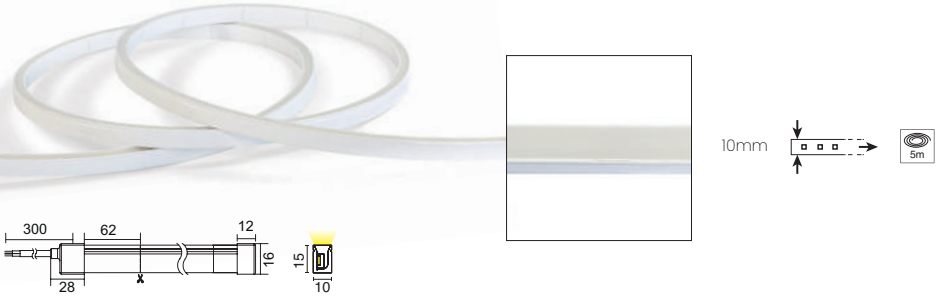

14,4W/m ● 50lm ● 150lm ● 351m

205CN-L0414FC0-00

2 grapas de fijación/m incluidas – 2 fixing clips/m included

98
LED/m



Grapa extra – Extra staple

GRA_205CN



Accesorio – Accessory

TAP_SET.IP65.SENARGB

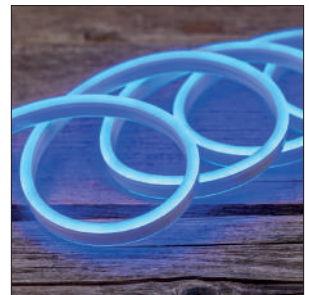
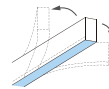

**Alimentadores
Power supplies**

P_239

VOLGA

IP 65



2700K
3000K
4000K



Recomendaciones de uso e instalación – Recommendations for use and installation (P_872)

DIRECTO A RED
MAINS VOLTAGE

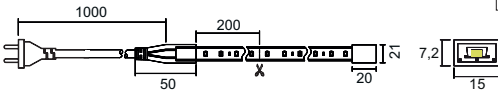

13W/m 1425lm/m **2700K**

13W/m 1475lm/m **3000K**

13W/m 1505lm/m **4000K**

204CH-L3013BC0-00

204CH-L3113BC0-00

204CH-L3313BC0-00



Accesorio – Accessory
CAB.SET.13.VOLGA

VOLGA

IP 65



2700K
3000K 4000K



Recomendaciones de uso e instalación – Recommendations for use and installation (P_872)

DIRECTO A RED
MAINS VOLTAGE

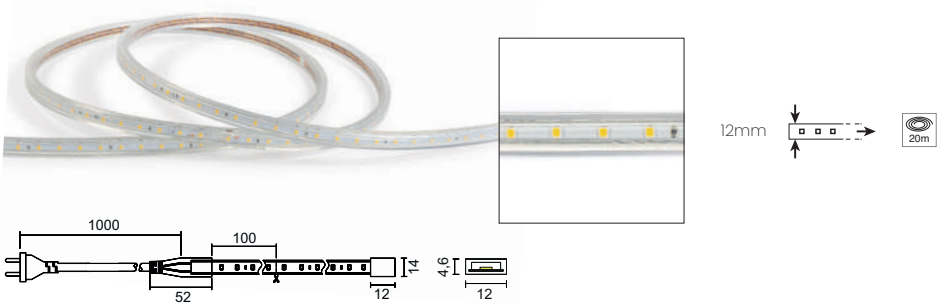

19W/m 1940lm/m **2700K**

19W/m 2070lm/m **3000K**

19W/m 2150lm/m **4000K**

204CH-L3017BC0-00

204CH-L3117BC0-00

204CH-L3317BC0-00



Accesorio – Accessory
CABSET.I9.VOLGA

PERFILES – PROFILES



Superficie – Surface



KIT A50

Perfil_Profile (2m)

Difusor opal_Opal diffuser (2m)

Tapa inicial y final_Initial and end cover

Grapas_Staples (x4)

A50-778-01-KIT-2M-OP

A50-778-02-KIT-2M-OP

A50-778-39-KIT-2M-OP

ALU

PC
OPAL

Difusores_Diffusers (2m)

A50-DIF-29 (Transparente_Transparent)

A50-DIF-02 (Negro_Black)

A50-DIF-08 (Naranja_Orange)

A50-DIF-07 (Rojo_Red)

A50-DIF-05 (Verde_Green)

A50-DIF-06 (Azul_Blue)

A50-DIF-60D (60° Transparente_Transparent)

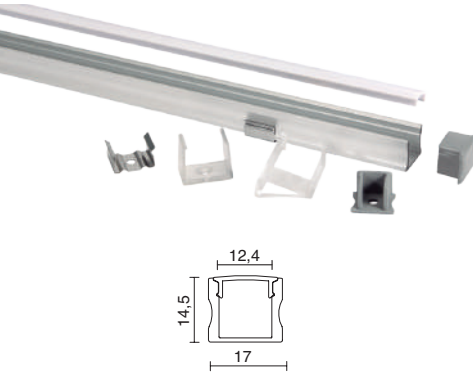

KIT A63

Perfil_Profile (2m)

Difusor opal_Opal diffuser (2m)

Tapa inicial y final_Initial and end cover

Grapas_Staples (x4)

A63-778-39-KIT-2M-OP

ALU

PC
OPAL

Difusores_Diffusers (2m)

A50-DIF-29 (Transparente_Transparent)

A50-DIF-02 (Negro_Black)

A50-DIF-08 (Naranja_Orange)

A50-DIF-07 (Rojo_Red)

A50-DIF-05 (Verde_Green)

A50-DIF-06 (Azul_Blue)

A50-DIF-60D (60° Transparente_Transparent)



Perfil_Profile

A67A-778-39-2M (2m)

A67A-778-39-3M (3m)

ALU

PERFILES – PROFILES



Superficie – Surface

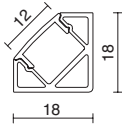

KIT A52

Perfil_Profile
 Difusor opal_Opal diffuser
 Tapa inicial y final_Initial and end cover
 Grapas_Staples (x4)

- A52-778-39-KIT-2M-OP (2m)
- A52-778-39-KIT-3M-OP (3m)



Difusor transparente_Transparent diffuser (3m)

- A50D-778-00

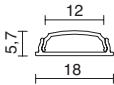
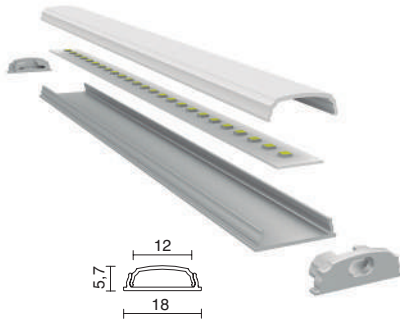

KIT A66

Perfil_Profile
 Difusor opal_Opal diffuser
 Tapa inicial y final_Initial and end cover
 Grapas_Staples (x4)

- A66-778-39-KIT-2M-OP (2m)
- A66-778-39-KIT-3M-OP (3m)

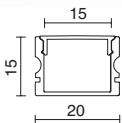

KIT A71

Perfil_Profile (2m)
 Difusor opal_Opal diffuser (2m)
 Tapa inicial y final_Initial and end cover
 Grapas_Staples (x4)

- A71-778-39-KIT-2M-OP



PERFILES – PROFILES



Empotrable – Recessed

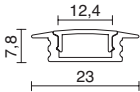

KIT A51

Perfil_Profile (2m)
Difusor opal_Opal diffuser (2m)
Tapa inicial y final_Initial and end cover
Grapas_Staples (x4)

- A51-778-01-KIT-2M-OP
- A51-778-02-KIT-2M-OP
- A51-778-39-KIT-2M-OP



Difusores_Diffusers (2m)

- A50-DIF-29 (Transparente_Transparent)
- A50-DIF-02 (Negro_Black)
- A50-DIF-08 (Naranja_Orange)
- A50-DIF-07 (Rojo_Red)
- A50-DIF-05 (Verde_Green)
- A50-DIF-06 (Azul_Blue)
- A50-DIF-60D (60° Transparente_Transparent)

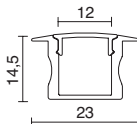

KIT A64

Perfil_Profile
Difusor opal_Opal diffuser
Tapa inicial y final_Initial and end cover
Grapas_Staples (x4)

- A64-778-39-KIT-2M-OP (2m)
- A64-778-39-KIT-3M-OP (3m)



Difusor transparente_Transparent diffuser (3m)

- A50D-778-00

PERFILES – PROFILES



Empotrable – Recessed

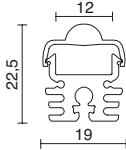

KIT A68

Perfil_Profile
Difusor opal_Opal diffuser
Tapa inicial y final_Initial and end cover
Grapas_Staples (x4)



- A68-778-39-KIT-2M-OP (2m)
- A68-778-39-KIT-3M-OP (3m)

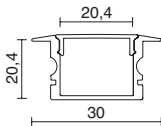

KIT A72

Perfil_Profile
Difusor opal_Opal diffuser
Tapa inicial y final_Initial and end cover
Grapas_Staples (x4)

- A72-778-39-KIT-2M-OP (2m)
- A72-778-39-KIT-3M-OP (3m)



Difusor transparente_Transparent diffuser (3m)

- A71D-778-00

PERFILES – PROFILES



Suspensión – Pendant



KIT A69

Perfil_Profile
Difusor opal_Opal diffuser
Tapa inicial y final_Initial and end cover
Grapas_Staples (x4)

■ A69-778-39-KIT-2M-OP (2m)

■ A69-778-39-KIT-3M-OP (3m)

ALU

PC
OPAL

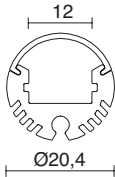

Suspensión (altura máxima 3m)
Suspension (maximum height 3m)

A69J-778-00

*Recomendación
 Recommendation
 1 unit/m*



Soporte armario
Wardrobe support

A69I-778-00

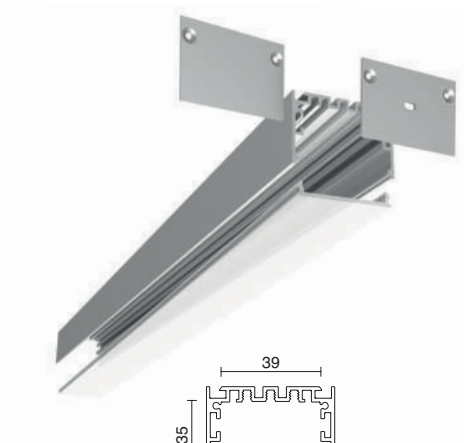

KIT A70

Perfil_Profile
Difusor opal_Opal diffuser
Tapa inicial y final_Initial and end cover

■ A70-778-39-KIT-2M-OP (2m)

■ A70-778-39-KIT-3M-OP (3m)

ALU

PC
OPAL

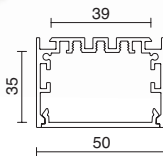

Compatibilidad tira LED con perfil LED strip compatibility

		PERFILERIA ALUMINIO – ALUMINUM PROFILING											
		A50	A63	A52	A66	A51	A64	A68	A69	A70	A71	A72	
TIRAS LED – LED STRIPS	IP20	200AS-	●	●	●	●	●	●	●	●	●	●	●
		201AS-	●	●	●	●	●	●	●	●	●	●	●
		202AC	●	●	●	●	●	●	●	●	●	●	●
		203AS-	●	●	●	●	●	●	●	●	●	●	●
		204AS-	●	●	●	●	●	●	●	●	●	●	●
		206AS-	●	●	●	●	●	●	●	●	●	●	●
	IP67	200DS-									●	●	●
		201DS-									●	●	●
		202DS-									●	●	●
		203DS-	●	●	●	●	●	●	●	●	●	●	●
		204DS-										●	●
	IP65	204CH	No requiere perfilera de aluminio Does not require aluminum profiles										
		205CN-											
		207CN-											

Servicio de corte y soldadura, consultar con departamento de ventas.
Cutting and welding service, consult with sales department.

CONTROL REMOTO DE RADIOFRECUENCIA RADIO FREQUENCY REMOTE CONTROL

Panel Táctil universal DMX – DMX universal Touch Panel (86 x 86 x 36mm)

CONT.T15

- Diferentes tipos de controladores Monocolor, RGB,RGBW, etc. con un solo panel.
- Control cromático táctil.
- Distancia de 10 m.
- Capacidad de control en 4 zonas.
- Different types of controllers Monocolor, RGB, RGBW, etc. with a single panel.
- Touch color control.
- Distance of 10 m.
- Control capacity in 4 zones.



Cableado
Wiring



Mando Universal – Universal remote control (140 x 60 x 26mm)

CONT.RT10

- Diferentes tipos de controladores Monocolor, RGB,RGBW, etc. con un solo mando.
- Control cromático táctil.
- Capacidad de control en 4 zonas diferentes con el mismo o diferente tipo de controlador en cada zona.
- Posibilidad de configurar cada zona.
- Distancia de 30 m.
- Working Voltage: 3Vdc (2xAAA no included).
- Different types of controllers Monocolor, RGB, RGBW, etc. with a single remote control.
- Touch color control.
- Control capacity in 4 different zones with the same or different type of controller in each zone.
- Possibility of configuring each zone.
- Distance of 30 m.
- Working Voltage: 3Vdc (2xAAA not included).



CONTROLADORES REMOTOS REMOTE CONTROLLERS

Controlador Monocolor – Monocolor Controller (97 x 33 x 18 mm)



CONT.V1

Control: RF 2.4GHz or PUSH Dim
 IN: 5-36Vdc
 OUT: 5-36Vdc
 Output Current: 1 Channels / 8A (per channel)
 Output Power: 192W (24V)



Controlador doble color (blanco tunable) – Dual color controller (tunable white) (175 x 45 x 27 mm)



CONT.V2-L

Control: RF 2.4GHz or PUSH Dim
 IN: 12-48Vdc
 OUT: 2x(12-48)Vdc
 Output Current: 2 Channels / 8A (per channel)
 Output Power: 2x192W (24V)



- Encendido y regulación suavizados sin parpadeo.
- Cada controlador acepta hasta 10 mandos universales.
- Con un solo mando se pueden regular ilimitados controladores.
- Función de autotransmisión: un controlador puede repetir la señal a otro controlador ubicado hasta 15m, concatenando hasta 100m.
- Verifique la corriente de salida para dimensionar la longitud y la potencia de las tiras LED asociadas.
- Regulación con memoria.
- Distancia: 30m (desde el mando al controlador directamente).
- Flicker-free switching on and regulation smoothed.
- Each controller accepts up to 10 universal remote controllers.
- Unlimited controllers can be regulated with a single remote control.
- Autotransmission function: one controller can repeat the signal to another controller located up to 15m, concatenating up to 100m.
- Check the output current to size the length and power of the associated LED strips.
- Regulation with memory.
- Distance: 30m (from remote control to head controller directly).

CONTROLADORES REMOTOS REMOTE CONTROLLERS

Controlador RGB/RGBW RGB / RGBW controller (175 x 45 x 27 mm)



CONT.V4

Control: RF 2.4GHz or PUSH Dim
 IN: 12-48Vdc
 OUT: 4x (12-48Vdc)
 Output Current: 4 Channels / 5A (per channel)
 Output Power: 4x (120W (24V))



- Controlador adecuado para tiras LED RGB y RGBW.
- Encendido y regulación suavizados sin parpadeo.
- Pulsador puede controlar el encendido/apagado y la regulación; así como gestionar hasta 8 escenas.
- Con cada controlador acepta hasta 10 mandos universales.
- Puede, también, utilizarse como regulador de doble color o monocolor con buena compatibilidad.
- Función de auto transmisión: se puede repetir la señal a otro controlador hasta 15m, concatenando hasta 100m.
- Auto sincronizado: diferentes controladores pueden regularse a la vez cuanto están asociados al mismo mando, con el mismo modo dinámico y velocidad.
- Verifique la corriente de salida para dimensionar la longitud y la potencia de las tiras LED asociadas.
- Regulación con memoria.
- Distancia: 30 m (desde el control remoto al controlador directamente).
- Controller suitable for RGB and RGBW LED strips.
- Flicker-free switching on and regulation smoothed.
- Push button can control on / off and regulation; as well as managing up to 8 scenes.
- With each controller accepts up to 10 universal remote controllers.
- It can also be used as a double or single color regulator with good compatibility.
- Auto transmission function: the signal can be repeated to another controller up to 15m, concatenating up to 100m.
- Synchronized auto: different controllers can be regulated at the same time when they are associated with the same command, with the same dynamic mode and speed.
- Check the output current to size the length and power of the associated LED strips.
- Regulation with memory.
- Distance: 30m (from remote control to controller directly).

CONTROLADORES REMOTOS

REMOTE CONTROLLERS

Controlador RGB + Doble Color (Blanco Tuneable)

RGB + Dual Color Controller (Tunable White) (170 x 50 x 23 mm)



CONT.V5

Control: RF 2.4GHz
 IN: 12-48Vdc or PUSH DIM
 OUT: 5x (12-48Vdc)
 Output Current: 5 Channels / 4A (per channel)
 Distance: 30m
 Output Power: 5x (120W (24V))



- Controlador adecuado para tiras LED RGB+CCT (RGB y doble color en la misma tira).
- Posibilidad de configurar uso conjunto de RGB + CCT o separado.
- Puede utilizarse, también, como regulador monocolor con buena compatibilidad.
- Verifique la corriente de salida para dimensionar la longitud y la potencia de las tiras LED asociadas.
- Cada controlador acepta hasta 10 mandos universales.
- Regulación con memoria.
- Distancia: 30 m (desde el control remoto al controlador directamente).
- Controller suitable for RGB + CCT LED strips (RGB and double color on the same strip).
- Possibility of configuring joint use of RGB + CCT or separately.
- It can also be used as a single color regulator with good compatibility.
- Check the output current to size the length and power of the associated LED strips.
- Each controller accepts up to 10 universal remote controllers.
- Regulation with memory.
- Distance: 30m (from remote control to controller directly).

CONTROLADORES REMOTOS REMOTE CONTROLLERS

Controlador RGB/RGBW IP67 RGB / RGBW controller IP67 (175 x 45 x 27 mm)



CONT.V4WP

Control: RF 2.4GHz or PUSH Switch
IN: 12-36Vdc
OUT: 4x (12-36Vdc)
Output Current: 4 Channels / 5A (per channel)
Output Power: 4x (120W (24V))



- Encendido y regulación suavizados sin parpadeo para aplicaciones de exterior.
- Conectado a un pulsador puede controlar el encendido/apagado y la regulación; así como gestionar hasta 8 escenas
- Cada controlador acepta hasta 10 mandos universales
- Puede, también, utilizarse como regulador de doble color o monocolor con buena compatibilidad.
- Función de auto transmisión y Auto sincronizado.
- Verifique la corriente de salida para dimensionar la longitud y la potencia de las tiras LED asociadas.
- Regulación con memoria.
- Distancia: 30 m (desde el control remoto al controlador directamente).
- Flicker-free smoothed on and dimming for outdoor applications.
- Connected to a push button it can control the on / off and regulation; as well as manage up to 8 scenes.
- Each controller accepts up to 10 universal remote controllers.
- It can also be used as a double or single color regulator with good compatibility.
- Auto transmission function and Auto synchronized.
- Check the output current to size the length and power of the associated LED strips.
- Regulation with memory.
- Distance: 30m (from remote control to controller directly).

Controlador bluetooth (CASAMBI) Bluetooth controller (CASAMBI) (72,6 x 30 x 18 mm)



CONT.CBU-PWM4

Control: RF 2.4GHz or PUSH Switch
IN: 12-36Vdc
OUT: 12-36Vdc
Output Current: 4 Channels / 5A (per channel)



- Controlador CBU-PWM4 con 4 canales de salida PWM independientes.
- Configurable para control de blanco, blanco dinámico, RGB ó RGBW.
- Controlar mediante el sistema Bluetooth CASAMBI, que ofrece una APP gratuita descargable desde la Apple Store y Google Play que permite crear escenas, grupos, animaciones de una forma intuitiva y rápida.
- CBU-PWM4 controller with 4 independent PWM output channels.
- Configurable to control white, dynamic white, RGB or RGBW.
- Control through the CASAMBI Bluetooth system, which offers a free APP downloadable from the Apple Store and Google Play that allows you to create scenes, groups, animations in an intuitive and fast way.

CONTROLADORES REMOTOS POR VOZ Y/O WIFI REMOTE CONTROLLERS BY VOICE AND/OR WIFI

Controlador Maestro 2 en 1 con función Pulsador
2-in-1 Master Controller with Push Button function (114 x 38 x 20 mm)



CONT.WT1

Control: VOZ (Echo o Google Assitant)
APP Tuya // RF y WIFI // PUSH
Input Voltage: 12-36Vdc
Output Voltage: 2 x (12-36)Vdc
Output Current: 5A / channel



- Controlador Maestro 2 en 1 para control de tiras LED Monocolor y CCT (doble color).
- Puede funcionar como convertidor WiFi-RF para, en función maestro, poder controlar diferentes dispositivos, de igual tipo de luz, mediante VOZ, APP Tuya y PUSH.
- Control, mediante APP Tuya, de ON/OFF, brillo y Temperatura de color (CCT) de encendidos programados, escenas, control en remoto.
- Control por VOZ, gracias a Tuya, a través de Amazon ECHO (ALEXA) o Google Assitant.
- Configuración sencilla por medio de pulsaciones.
- 2-in-1 Master Controller to control Monocolor and CCT (double color) LED strips.
- It can function as a WiFi-RF converter to control different devices, of the same type of light, in a master function, through VOICE, Tuya APP and PUSH.
- Control, through APP Tuya, of ON / OFF, brightness and Color Temperature (CCT) of programmed ignitions, scenes, remote control.
- VOICE control, thanks to Tuya, through Amazon ECHO (ALEXA) or Google Assistant.
- Simple configuration by means of keystrokes.

CONTROLADORES REMOTOS POR VOZ Y/O WIFI REMOTE CONTROLLERS BY VOICE AND/OR WIFI

Controlador Maestro 5 en 1 - WIFI (TUYA) . Compatible ALEXA.
5 in 1 Master Controller - WIFI (TUYA). ALEXA compatible. (114 x 38 x 20 mm)



CONT.WT5

Control: VOICE (Echo o Google Assistant)
 APP Tuya // RF y WIFI
 Input Voltage: 12-24Vdc
 Output Voltage: 5 x (12-24)Vdc
 Output Current: 3A / channel



- Controlador Maestro 5 en 1 para control de tiras LED Monocolor, CCT, RGB, RGBW y RGB + CCT.
- Puede funcionar como convertidor WiFi-RF para, en funciónmaestro, poder controlar diferentes dispositivos, de igual tipo de luz, mediante VOZ y APP Tuya.
- Control, mediante APP Tuya, de ON/OFF, brillo, CCT, RGB/RGBW, RGB + CCT, encendidos programados, escenas, control en remoto.
- Control por VOZ, gracias a Tuya, a través de Amazon ECHO (ALEXA) o Google Asisstant.
- Configuración sencilla por medio de pulsaciones.
- 5 in 1 Master Controller to control Monocolor, CCT, RGB, RGBW and RGB + CCT LED strips.
- It can function as a WiFi-RF converter for, as a master, to be able to control different devices, of the same type of light, through VOICE and Tuya APP_.
- Control, through APP Tuya, of ON / OFF, brightness, CCT, RGB / RGBW, RGB + CCT, programmed ignitions, scenes, remote control.
- VOICE control, thanks to Tuya, through Amazon ECHO (ALEXA) or Google Assistant.
- Simple configuration by means of keystrokes.

CONTROLADORES REMOTOS POR VOZ Y/O WIFI REMOTE CONTROLLERS BY VOICE AND/OR WIFI

Tuya APP control cloud

Tuya APP cloud control (52 x 52 x 26 mm)



CONT.LIWT

Control: APP Tuya // RF // PUSH Dim
Input Voltage: 100-240Vac
Output signal: 0/1-10V (20mA)
Output Current: 5A / channel



- Salida de 1 canal de señal 0 / 1-10V, conectar con driver regulable 0 / 1-10V.
 - Control mediante Tuya APP, encendido / apagado, ajuste de brillo, retardo de encendido / apagado de luz, temporizador, función de escena, control de voz, compatible con Amazon ECHO .
 - Salida de 0-10 V seleccionable mediante interruptor DIP, 256 niveles 0-100% de atenuación suave sin flash.
 - Compatibilidad con control remoto de atenuación de zona única o zona múltiple RF 2.4G.
 - Puede funcionar como convertidor WiFi-RF, luego use la APLICACIÓN Tuya para controlar uno o más controladores LED de atenuación de RF o controladores sincrónicamente.
 - Conecte con un interruptor de empuje externo para lograr la función de atenuación de encendido / apagado y 0-100%.
 - Fácil de colocar en una caja de conexiones de pared estándar detrás de un interruptor.
-
- 1 channel 0 / 1-10V signal output, connect with 0 / 1-10V dimmable driver.
 - Control by Tuya APP, on / off, brightness adjustment, light on / off delay, timer, scene function, voice control, compatible with Amazon ECHO.
 - Selectable 0-10V output via DIP switch, 256 levels 0-100% smooth dimming without flash.
 - Support for 2.4G RF single zone or multi zone dimming remote control.
 - It can work as a WiFi-RF converter, then use the Tuya APP to control one or more RF dimming LED drivers or drivers synchronously.
 - Connect with external push switch to achieve on / off and 0-100% dimming function.
 - Easy to fit in a standard wall junction box behind a switch.

CONTROLADORES REMOTOS DALI DALI REMOTE CONTROLLER



DALI Dimmer
(175 x 45 x 27 mm)

CONT.DA1

Input Voltage: 12-48VDC
Input signal: DALI+Push dim
Output Current:
1 DALI address, 15A
Output Power:
180W (12V) / 360W (24V)



DALI Dimmer
(175 x 45 x 27 mm)

CONT.DA4

Input Voltage: 12-48VDC
Input signal: DALI+Push dim
Output Current:
4 DALI address, 15A
Output Power:
180W (12V) / 360W (24V)



1AC Triac DALI Dimmer
(175 x 45 x 27 mm)



CONT.DT

Input Voltage: 100-240Vac
Input signal:
DALI + Push dim + Corte Fas.
Output Current: Max 1,5A
Output Power: 150-360W

AMPLIFICADORES AMPLIFIERS

Acondiciona la señal a lo largo del tramo de tira LED, posibilitando que la intensidad que pasa por la tira siga estable y sin ninguna caída en la totalidad de su longitud – It conditions the signal along the length of the LED strip, making it possible for the intensity that passes through the strip to remain stable and without any drop over its entire length.



Amplificador 1 canal
1 channel amplifier
(97x33x18 mm)

CONT.EV1-S

Input Voltage: 12-24VDC
Output Current: 1channel, 15A
Output Power: 12V<180W, 24V<360W



Amplificador 4 canales
4-channel amplifier
(175x45x27 mm)

CONT.EV4

Input Voltage: 12-36VDC
Output Current: 4channel, 5A/canal
Output Power: 4x 60W (12V), 4x 120W 24V, 4x 180W (36V)

ALIMENTADORES POWER SUPPLIES

IP
20



35W (84 x 57 x 29,5 mm)

B02Q-X3335F-00



96W (200,5 x 69,5 x 35 mm)

B02Q-X3396F-00



75W (180 x 52 x 30 mm)

B02C-X3375F-00

30W (153x41x32 mm)

B02C-X3330F-00

60W (180 x 52 x 30 mm)

B02C-X3360F-00



VSS VOSSLÖH SCHWARZ

120W (300 x 40 x 30 mm)

B02C-X33A3F-00

180W (345 x 50 x 35 mm)

B02V-X33J5F-00



40W (187 x 45 x 31 mm)

B02L-X3340F-00

80W (290 x 45 x 31 mm)

B02L-X3380F-00



DALI PUSH

VSS VOSSLÖH SCHWARZ

150W (290 x 45 31 mm)

B02L-X33A4F-00

250W (431 x 45 x 31 mm)

B02L-X33A6F-00

IP
67



35W (148 x 40 x 30 mm)

B02R-X3335F-00

60W (162,5 x 42,5 x 32 mm)

B02R-X3360F-00



MW MEAN WELL



100W (191 x 63 x 37,5 mm)

B02R-X33A1F-01

150W (191 x 63 x 37,5 mm)

B02R-X33A4F-00

60W (150 x 53 x 35 mm)

B02H-X3360F-00

90W (171 x 63 x 37,5 mm)

B02H-X3390F-00



DALI MW MEAN WELL

120W (190 x 52 x 37 mm)

B02H-X33A3F-00

200W (195 x 68 x 39,5 mm)

B02H-X33A5F-00



40W (187 x 45 x 31 mm)

B02W-X3340F-00

80W (290 x 45 x 31 mm)

B02W-X3380F-00



VSS VOSSLÖH SCHWARZ DALI PUSH

150W (290 x 45 x 31 mm)

B02W-X33A4F-00



100W (156 x 48 x 33 mm)

B02Y-X33A1F-00

35W (110 x 40 x 29,5 mm)

B02Y-X3335F-00

60W (156 x 42 x 30 mm)

B02Y-X3360F-00



150W (156 x 48 x 33 mm)

B02Y-X33A4F-00

240W (220 x 63 x 42 mm)

B02Y-X33A6F-00

VSS VOSSLÖH SCHWARZ

Fast Movers_



Acabado blanco – White finish

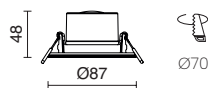

LED SMD AC 6,5W

□ 1036A-L4107BA0-01



K SELECT	2700K	570lm
	3000K	630lm
	4000K	630lm

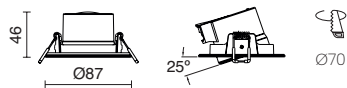

LED SMD AC 4,8W

□ 1036B-L4105B30-01



K SELECT	2700K	470lm
	3000K	500lm
	4000K	500lm

Aro decorativo – Decorative ring



■ A13A-1036-02

□ A13B-1036-01

■ A13B-1036-02



KRAO



Acabado blanco – White finish

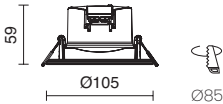

1036C-



1036E-



LED SMD AC 10,5W

□ 1036C-L4109BAC-01



LED SMD AC 8W

□ 1036E-L4108BAZ-01

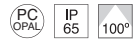

K SELECT	2700K	850lm
	3000K	1000lm
	4000K	950lm

K SELECT	2700K	650lm
	3000K	700lm
	4000K	700lm

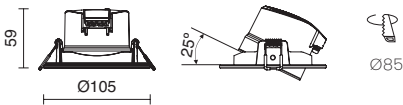

LED SMD AC 9W

□ 1036D-L4109B3C-01

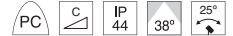

K SELECT	2700K	720lm
	3000K	850lm
	4000K	800lm

Aro decorativo – Decorative ring



■ AI3C-1036-02



NOK20



Acabado blanco, negro u oro – White, black or gold finish

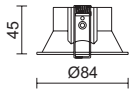

- D20-824-01-01
- D20-824-02-02
- D20-824-47-47

Accesorio necesario – Necessary accessory



NOK30



Acabado blanco, negro u oro – White, black or gold finish

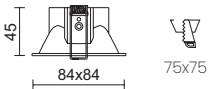

- D30-824-01-01
- D30-824-02-02
- D30-824-47-47

Accesorio necesario – Necessary accessory



ATOLON

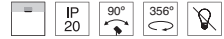

Acabado blanco, negro o gris – White, black or grey finish

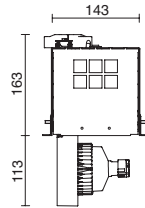
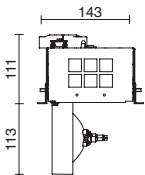

G53 LED AR111 12V / QR-LP 111 75W max.

- 738F-G18RCB-01
- 738F-G18RCB-02
- 738F-G18RCB-03



GU10 LED AR111 230V 15W max.

- 738F-G21XIB-01
- 738F-G21XIB-02
- 738F-G21XIB-03



Filtros de conversión para pescado, marisco, verdura, carne o pan
Conversion filters for fish, seafood, vegetables, meat or bread

	SEAFOOD	A14A-738-00	for 3000K
	VEG+FRUIT	A14A-738-00	
<hr/>			
	FISH	A14A-738-00	for 4000K
	MEAT	A14B-738-00	
	BREAD	A14C-738-00	

Porta filtros – Support for filters



ATOLON

Marcos – Frames



ACER

Acabado blanco, negro o gris – White, black or grey finish



- A45A-738-01
- A45A-738-02
- A45A-738-03



- A45B-738-01
- A45B-738-02
- A45B-738-03

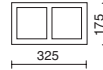

- A45C-738-01
- A45C-738-02
- A45C-738-03

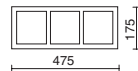

- A45D-738-01
- A45D-738-02
- A45D-738-03

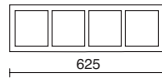

- A45E-738-01
- A45E-738-02
- A45E-738-03



LEN



Acabado blanco – White finish

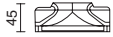

124X124

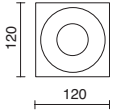

GUI0 Led Retrofit/QPAR-16 230V 50W

□ 798B-G2IX1B-01



Ø133

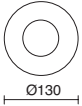

GUI0 Led Retrofit/QPAR-16 230V 50W

□ 798C-G2IX1B-01



Para techo de yeso – For plaster ceiling

Accesorio necesario – Necessary accessory



LED MODUL PRO

P_860

JANO



Acabado blanco – White finish

Para otros acabados, consultar – For other finishes, consult us

Con Driver remoto

With Remote Driver

Consult **110V**

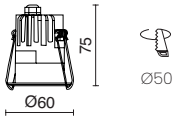

2700K
LED COB 7,5W 840lm

□ 818C-L3808B30-01

□ 818C-L3808B3D-01

3000K
LED COB 7,5W 881lm

□ 818C-L3908B30-01

□ 818C-L3908B3D-01

4000K
LED COB 7,5W 935lm

□ 818C-L4008B30-01

□ 818C-L4008B3D-01



PALMA



-01



-30



-02



-32



-45



-48

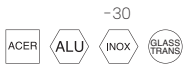

-30



Acabado blanco, negro, inox (-30), cromado (32), cromado mate (-45) o níquel mate (-48)
 White, black, stainless steel (-30), chrome (-32), matt chrome (-45) or matt nickel finish (-48)

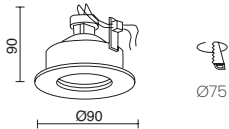

GU10

LED Retrofit / QPAR-16 230V 50W max.

- 750A-G42XIB-01
- 750A-G42XIB-02
- 750A-G42XIB-30
- 750A-G42XIB-32
- 750A-G42XIB-45
- 750A-G42XIB-48



GU5.3

LED Retrofit / QR-CBC 51 12V 50W max.

- 750A-G23XID-01
- 750A-G23XID-02
- 750A-G23XID-30
- 750A-G23XID-32
- 750A-G23XID-45
- 750A-G23XID-48



Accesorio necesario – Necessary accessory



MINI LUNA



-01



-02



-03



-32



-45



-48

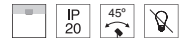

Acabado blanco, negro, gris, cromado (32), cromado mate (-45) o níquel mate (-48)
 White, black, grey, chrome (-32), matt chrome (-45) or matt nickel finish (-48)

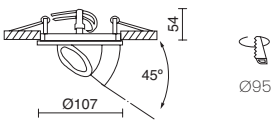

GU10

LED Retrofit / QPAR-16 50W max.

- 741A-G42XIB-01
- 741A-G42XIB-02
- 741A-G42XIB-03
- 741A-G42XIB-32
- 741A-G42XIB-45
- 741A-G42XIB-48



GU5.3

LED Retrofit / QR-CBC 51 50W max.

- 741A-G23XID-01
- 741A-G23XID-02
- 741A-G23XID-03
- 741A-G23XID-32
- 741A-G23XID-45
- 741A-G23XID-48



Accesorio necesario – Necessary accessory



NIX



Acabado blanco, negro, cromado mate (-45) o níquel mate (-48) – White, black, matt chrome (-45) or matt nickel finish (-48)



GU10

LED Retrofit / QPAR-16 230V 50W max.

- 780A-G42XIB-21
- 780A-G42XIB-02
- 780A-G42XIB-45
- 780A-G42XIB-48

GU5.3

LED Retrofit / QR-CBC 51 12V 50W max.

- 780A-G23XID-21
- 780A-G23XID-02
- 780A-G23XID-45
- 780A-G23XID-48



GU10

LED Retrofit / QPAR-16 230V 50W max.

- 780B-G42XIB-21
- 780B-G42XIB-02
- 780B-G42XIB-45
- 780B-G42XIB-48

GU5.3

LED Retrofit / QR-CBC 51 12V 50W max.

- 780B-G23XID-21
- 780B-G23XID-02
- 780B-G23XID-45
- 780B-G23XID-48

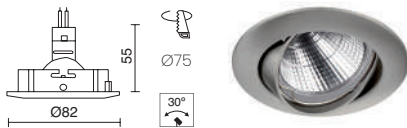

GU10

LED Retrofit / QPAR-16 230V 50W max.

- 780E-G42XIB-21
- 780E-G42XIB-02
- 780E-G42XIB-45
- 780E-G42XIB-48

GU5.3

LED Retrofit / QR-CBC 51 12V 50W max.

- 780E-G23XID-21
- 780E-G23XID-02
- 780E-G23XID-45
- 780E-G23XID-48



GU10

LED Retrofit / QPAR-16 230V 50W max.

- 780F-G42XIB-21
- 780F-G42XIB-02
- 780F-G42XIB-45
- 780F-G42XIB-48

GU5.3

LED Retrofit / QR-CBC 51 12V 50W max.

- 780F-G23XID-21
- 780F-G23XID-02
- 780F-G23XID-45
- 780F-G23XID-48

Accesorio necesario – Necessary accessory





CARPO

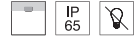

Acabado blanco – White finish

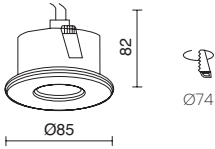

GU10

LED Retrofit / QPAR-16 230V 50W max.

□ 781B-G42X1B-01



GU5.3

LED Retrofit / QR-CBC 51 12V 50W max.

□ 781B-G23X1D-01



INEL



Acabado blanco – White finish

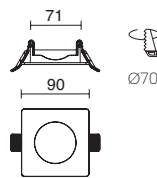
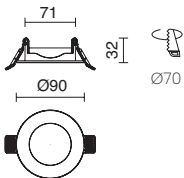

□ A13A-63I-01

□ A13B-63I-01

Accesorio necesario – Necessary accessory



KOS

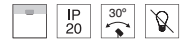

Acabado blanco – White finish

Lamps_P_860

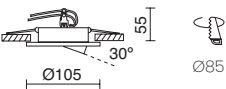

GU10
LED Retrofit / QPAR-16 230V 50W max.

□ 749B-G42XB-01



GU5.3
LED Retrofit / QR-CBC 51 12V 50W max.

□ 749B-G23XD-01



KALE



Acabado blanco – White finish

Con Driver remoto
With Remote Driver

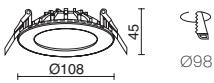

LED SMD 8W 470lm 3000K

□ 757B-L3108B-01

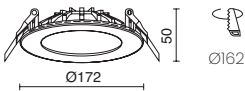

LED SMD 18,5W 1400lm 3000K

□ 757C-L3120B-01

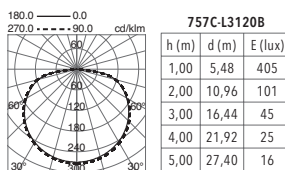
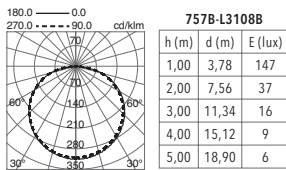

LEDA



Acabado blanco, negro o gris — White, black or grey finish

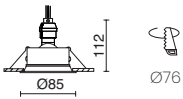

GU10

LED Retrofit / QPAR-16 230V 50W max.

- 752A-G42XIB-01
- 752A-G42XIB-02
- 752A-G42XIB-03



GU5.3

LED Retrofit / QR-CBC 51 12V 50W max.

- 752A-G23XID-01
- 752A-G23XID-02
- 752A-G23XID-03



Accesorio necesario — Necessary accessory



CALYPSO 3

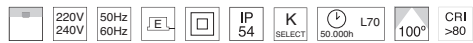

Acabado blanco – White finish

Con Driver remoto
With Remote Driver

Optional
Optional **110V**

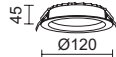

LED SMD 7W

□ 1080A-L4107B-01

LED SMD 13W

□ 1080B-L4113B-01

LED SMD 18W

□ 1080C-L4118B-01

LED SMD 25W

□ 1080D-L4125B-01

	K SELECT	Ø85	Ø120	Ø170	Ø228
	2700K	908lm	1634lm	2479lm	3600lm
	3000K	964lm	1813lm	2653lm	3848lm
	4000K	925lm	1800lm	2561lm	3713lm



HIMMEL



Acabado blanco – White finish

Con Driver remoto
With Remote Driver

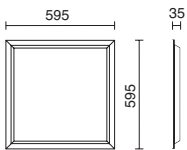

LED SMD 40W 3400lm **3000K**

□ 583C-L3140B-01

LED SMD 40W 3600lm **4000K**

□ 583C-L3340B-01

Para falso techo modular.
For modular ceiling.

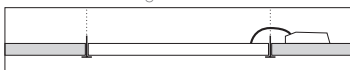

Kit de superficie
Surface mounted kit

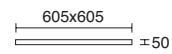

A20B-583-01



IBIZA



Acabado blanco, negro, cromado (-32) o cromado mate (-45)
 White, black, chrome (-32) or matt chrome finish (-45)

Disponible en 2700K, 4000K, 5000K
 Available in 2700K, 4000K, 5000K

Con Driver remoto
 With Remote Driver

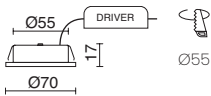

LED SMD 3,2W 290lm 3000K

- 753A-L3202B-01
- 753A-L3202B-02
- ◻ 753A-L3202B-32
- ◼ 753A-L3202B-45

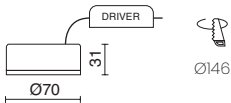

LED SMD 3,2W 290lm 3000K

- 753B-L3202B-01
- 753B-L3202B-02
- ◻ 753B-L3202B-32
- ◼ 753B-L3202B-45



CARME

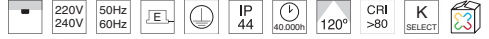

Acabado blanco – White finish

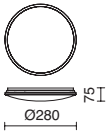

LED SMD **16,5W**

□ 731B-L4118B-01

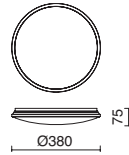

LED SMD **27,5W**

□ 731C-L4130B-01

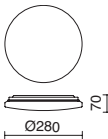

LED SMD **16,5W**

□ 731D-L4118B-28

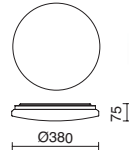

LED SMD **27,5W**

□ 731E-L4130B-28



□ 731F-L4118R-28

□ 731G-L4130R-28

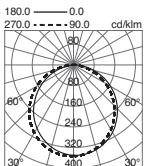

h (m)	d (m)	E (lux)
1,00	3,45	856
2,00	6,90	214
3,00	10,35	95
4,00	13,80	54
5,00	17,25	34

h (m)	d (m)	E (lux)
1,00	3,45	1038
2,00	6,90	260
3,00	10,35	115
4,00	13,80	65
5,00	17,25	42

h (m)	d (m)	E (lux)
1,00	3,45	965
2,00	6,90	241
3,00	10,35	107
4,00	13,80	60
5,00	17,25	39

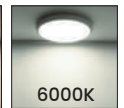

K SELECT	16,5W	27,5W
	3000K	1870lm
4000K	2270lm	3330lm
6000K	2110lm	3090lm

LAUTAN



Suspensión no incluida
Suspension not included



Acabado antracita – Anthracite finish

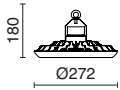

100W

LED SMD 16000lm **4000K**

□ 1048A-L33RAB-04

LED SMD 16000lm **6500K**

□ 1048A-L37RAB-04

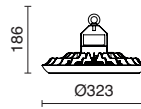

150W

LED SMD 23020lm **6500K**

□ 1048B-L37RAB-04

200W

LED SMD 28890lm **4000K**

□ 1048C-L33RAB-04

LED SMD 28890lm **6500K**

□ 1048C-L37RAB-04

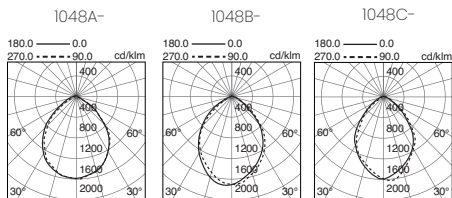



COVER



Acabado blanco – White finish



Cajetín universal redondo para empotrar en hormigón o ladrillo **NO INCLUIDO**.
 Universal recessed round box to install in concrete or brick wall **NOT INCLUDED**.

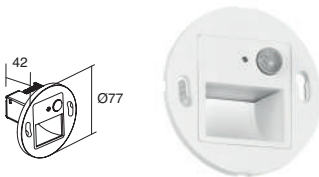

LED SMD 2W

□ 1053A-L4102B90-01

K SELECT	2700K	148lm
	3200K	154lm
	4000K	168lm



Area de detección – Detection area _ <6m
 Angulo de detección – Detection angle _ 120°
 Tiempo de espera – Hold time _ 5seg. - 8min.
 Sensor de luz diurna – Daylight sensor _ <10lux

Accesorio necesario – Necessary accessory

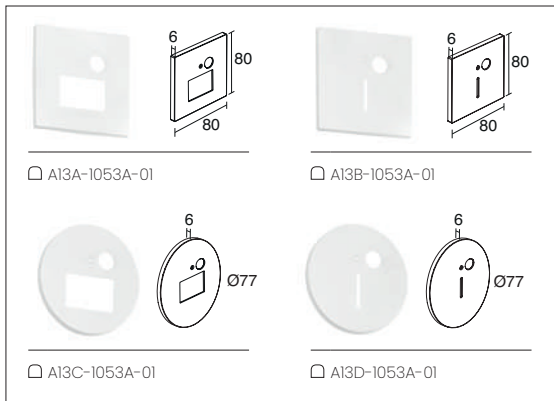

1053A-L4102B90-01 + A13A-1053A-01



WINDOW 2



ALU



Acabado blanco o aluminio anodizado – White or anodized aluminum finish

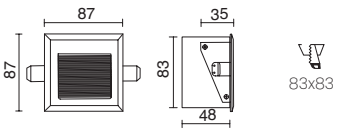

LED CREE 3W 160lm 3000K

□ 726A-L0103B-01

■ 726A-L0103B-39

LIGUR



Acabado blanco o aluminio anodizado — White or anodized aluminum finish

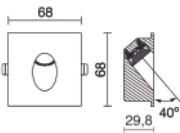

64X64

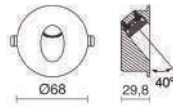

Ø55

LED CREE 3W 160lm 3000K

□ 706A-L0103B-01

■ 706A-L0103B-39

LED CREE 3W 160lm 3000K

□ 706B-L0103B-01

■ 706B-L0103B-39

OFFICE



Acabado blanco o negro – Black or white finish

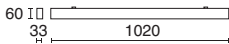

LED SMD 36W 3392lm 4000K

□ 1046A-L3336B-01

■ 1046A-L3336B-02

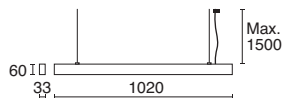

LED SMD 36W 3392lm 4000K

□ 1046B-L3336B-01

■ 1046B-L3336B-02





TEN



Carril no incluido – Track not included



ALU

110V
240V



IP 20

90°

355°



Acabado blanco o negro – White or black finish

Lamps P_860

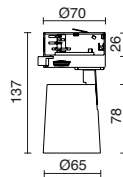
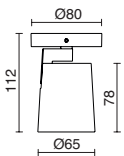

GU10 7,5W max. **LED Retrofit**

- 1021A-G21X1A-01
- 1021A-G21X1A-02



GU10 7,5W max. **LED Retrofit**

- 1021B-G21X1A-01
- 1021B-G21X1A-02



Carril – Track
P_ 278-281





AMY



Carril no incluido – Track not included



Acabado blanco o negro – White or black finish

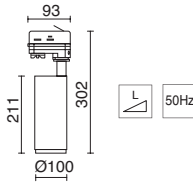
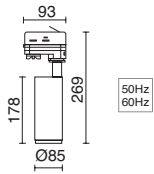

K SELECT	25W	30W
2700K	236lm	274lm
3000K	257lm	296lm
4000K	244lm	276lm

LED 25W

- 997A-L4125B20-01
- 997A-L4125B20-02

LED 30W

- 997B-L4130B2F-01
- 997B-L4130B2F-02

- 997A-L4125B30-01
- 997A-L4125B30-02

- 997B-L4130B3F-01
- 997B-L4130B3F-02

- 997A-L4125B60-01
- 997A-L4125B60-02

- 997B-L4130B6F-01
- 997B-L4130B6F-02



Adaptador para techo – Adapter for ceiling

- B25-X33X2B-01
- B25-X33X2B-02

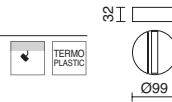

Carril – Track
P_ 278-281





HAITI



Acabado blanco, negro o gris – White, black or grey finish

Lamps P_860



G53 LED AR111 12V (DIM,C)

- 772B-G18RCB-01
- 772B-G18RCB-02
- 772B-G18RCB-03



G53 QR-LP 111 12V 75W max. (DIM,LC)

- 772B-H18RCB-01
- 772B-H18RCB-02
- 772B-H18RCB-03

Filtros de conversión para pescado, marisco, verdura, carne o pan
Conversion filters for fish, seafood, vegetables, meat or bread

	SEAFOOD	A14A-738-00	for 3000K
	VEG+FRUIT	A14A-738-00	
	FISH	A14A-738-00	for 4000K
	MEAT	A14B-738-00	
	BREAD	A14C-738-00	

Porta filtros – Support for filters

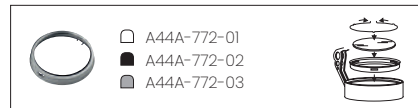

Aro customizable
Customizable ring



Carril – Track
P_ 278-281

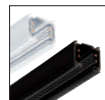

HAITI



Acabado blanco, negro o gris – White, black or grey finish

Lamps P_860

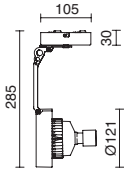

GUI0 LED AR111 230V

- 772B-G2IXIB-01
- 772B-G2IXIB-02
- 772B-G2IXIB-03



Carril no incluido – Track not included

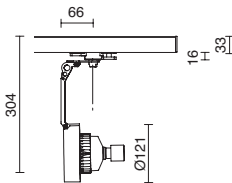

GUI0 LED AR111 230V

- 772A-G2IXIB-01
- 772A-G2IXIB-02
- 772A-G2IXIB-03



Filtros de conversión para pescado, marisco, verdura, carne o pan
Conversion filters for fish, seafood, vegetables, meat or bread

	SEAFOOD	A14A-738-00	for 3000K
	VEG+FRUIT	A14A-738-00	
	FISH	A14A-738-00	for 4000K
	MEAT	A14B-738-00	
	BREAD	A14C-738-00	

Porta filtros – Support for filters

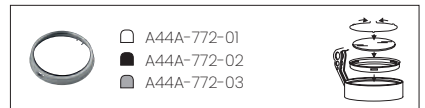

Aro customizable
Customizable ring



Carril – Track
P_ 278-281



TRACK

ALU



Acabado blanco, negro o aluminio anodizado – White, black or anodised aluminium finish

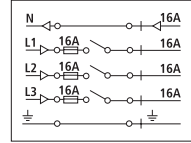
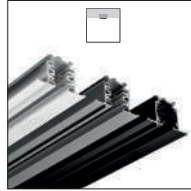
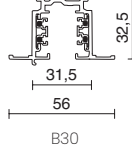
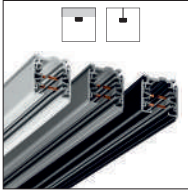
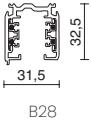

- 1m**
- B28A-X33X2B-01
 - B28A-X33X2B-02
 - B28A-X33X2B-39

- 2m**
- B28B-X33X2B-01
 - B28B-X33X2B-02
 - B28B-X33X2B-39

- 3m**
- B28C-X33X2B-01
 - B28C-X33X2B-02
 - B28C-X33X2B-39



- 1m**
- B30A-X33X2B-01
 - B30A-X33X2B-02
 - B30A-X33X2B-39

- 2m**
- B30B-X33X2B-01
 - B30B-X33X2B-02
 - B30B-X33X2B-39

- 3m**
- B30C-X33X2B-01
 - B30C-X33X2B-02
 - B30C-X33X2B-39



Alimentación derecha
Right Power Supply

- B28D-X33X2B-01
- B28D-X33X2B-02
- B28D-X33X2B-03

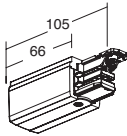

Alimentación izquierda
Left Power Supply

- B28E-X33X2B-01
- B28E-X33X2B-02
- B28E-X33X2B-03

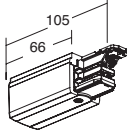

Alimentación central
Supply straight coupling

- B28H-X33X2B-01
- B28H-X33X2B-02
- B28H-X33X2B-03

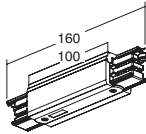

Unión flexible
Flexible junction coupling

- B28K-X33X2B-01
- B28K-X33X2B-02
- B28K-X33X2B-03

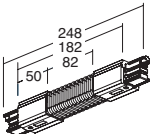

Unión en cruz
"X" junction coupling

- B28J-X33X2B-01
- B28J-X33X2B-02
- B28J-X33X2B-03

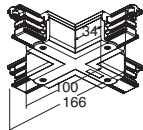

Codo 90° interior
90° in junction coupling

- B28G-X33X2B-01
- B28G-X33X2B-02
- B28G-X33X2B-03

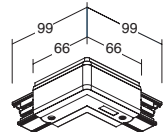

Codo 90° exterior
90° out junction coupling

- B28M-X33X2B-01
- B28M-X33X2B-02
- B28M-X33X2B-03

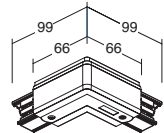

T derecha – Right Junction Coupling

- B28I-X33X2B-01
- B28I-X33X2B-02
- B28I-X33X2B-03

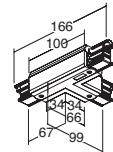

T izquierda – Left Junction Coupling

- B28N-X33X2B-01
- B28N-X33X2B-02
- B28N-X33X2B-03

Unión con contacto
Straight coupling with supply

- B28L-X33X2B-01
- B28L-X33X2B-02
- B28L-X33X2B-03

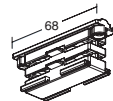

Tapa final
End cap

- A61G-786-01
- A61G-786-02
- A61G-786-03

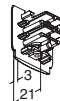

Acabado blanco, negro o gris – White, black or grey finish

Tapa lineal (carril empotrado)
Linear plate/cover (recessed track)

- A61H-786-01
- A61H-786-02
- A61H-786-03

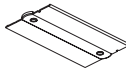

Para /For: B28E- B28D- B28H-

Tapa cruz (carril empotrado)
Cross cover (recessed track)

- A61J-786-01
- A61J-786-02
- A61J-786-03

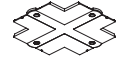

Para /For: B28G- B28M- B28I- B28N- B28J-

Base SCHUKO carril
SCHUKO base track

- B17O-X33X2B-01
- B17O-X33X2B-02

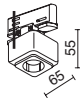

Adaptador universal
Universal adaptor

- B17F-X33X2B-01
- B17F-X33X2B-02
- B17F-X33X2B-03

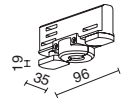

Leva para carril empotrado
Cam for recessed track

- A61M-786-03



Leva para techo o tija
Cam for ceiling or stem pendant

- A61E-786-01
- A61E-786-02
- A61E-786-03



Cable de acero
Steel cable

- A61A-786-01 (1500mm)
- A61A-786-02 (1500mm)
- A61A-786-03 (1500mm)

- A61B-786-01 (3000mm)
- A61B-786-02 (3000mm)
- A61B-786-03 (3000mm)



Tija
Stem Pendant

- A61C-786-01 (1000mm)
- A61C-786-02 (1000mm)

- A61D-786-01 (1000mm)
- A61D-786-02 (1000mm)

- A61H-786-39

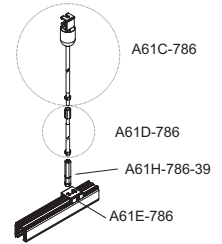

EJEMPLOS DE INSTALACIÓN — INSTALLATION EXAMPLES

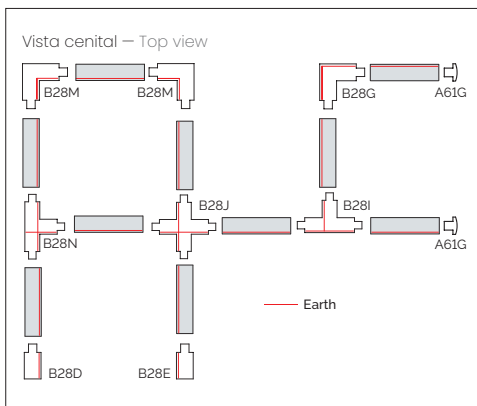

Herramienta para doblar conductores carril
Track conductor bending tool

A61N-786-00

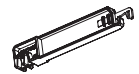

Corte carril a medida
 uso herramienta especial
 A61N-786-00



Video

Three-phase rail
 cut to length use of
 special tool A61N-786-00



Video

Acabado blanco, negro o gris — White, black or grey finish

TRACK



ALU



Acabado blanco, negro o aluminio anodizado – White, black or anodised aluminium finish

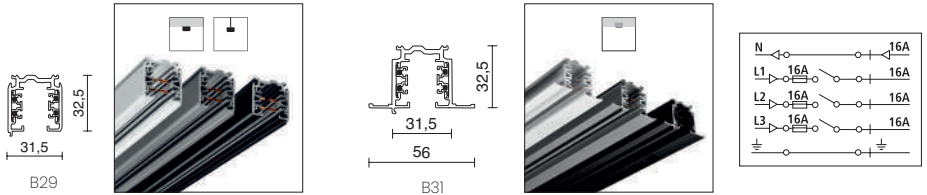

1m

- B29A-X33X2U-01
- B29A-X33X2U-02
- B29A-X33X2U-39

2m

- B29B-X33X2U-01
- B29B-X33X2U-02
- B29B-X33X2U-39

3m

- B29C-X33X2U-01
- B29C-X33X2U-02
- B29C-X33X2U-39



1m

- B31A-X33X2U-01
- B31A-X33X2U-02
- B31A-X33X2U-39

2m

- B31B-X33X2U-01
- B31B-X33X2U-02
- B31B-X33X2U-39

3m

- B31C-X33X2U-01
- B31C-X33X2U-02
- B31C-X33X2U-39



Alimentación derecha Right Power Supply

- B29D-X33X2U-01
- B29D-X33X2U-02
- B29D-X33X2U-03

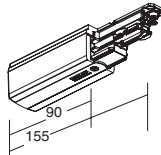

Codo 90° interior 90° in junction coupling

- B29F-X33X2U-01
- B29F-X33X2U-02
- B29F-X33X2U-03

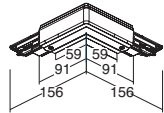

Alimentación izquierda Left Power Supply

- B29E-X33X2U-01
- B29E-X33X2U-02
- B29E-X33X2U-03

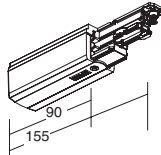

Codo 90° exterior 90° out junction coupling

- B29L-X33X2U-01
- B29L-X33X2U-02
- B29L-X33X2U-03

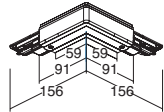

Tapa final End cap

- A61G-786-01
- A61G-786-02
- A61G-786-03

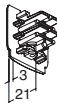

T derecha – Right Junction Coupling

- B29H-X33X2U-01
- B29H-X33X2U-02
- B29H-X33X2U-03

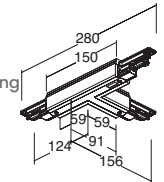

Unión flexible Flexible junction coupling

- B29J-X33X2U-01
- B29J-X33X2U-02
- B29J-X33X2U-03

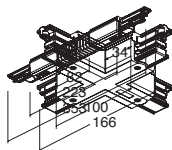

T izquierda – Left Junction Coupling

- B29M-X33X2U-01
- B29M-X33X2U-02
- B29M-X33X2U-03

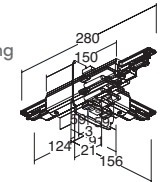

Acabado blanco, negro o gris – White, black or grey finish

Unión en cruz
"X" junction coupling

- B29I-X33X2U-01
- B29I-X33X2U-02
- B29I-X33X2U-03

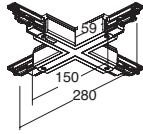

Unión con contacto
Linear / Contact Junction Coupling
(Supply Possibility)

- B29K-X33X2U-01
- B29K-X33X2U-02
- B29K-X33X2U-03

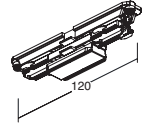

Tapa lineal (carril empotrado)
Linear plate/cover (recessed track)

- A61K-786-01
- A61K-786-02
- A61K-786-03

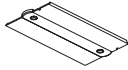

Tapa cruz (carril empotrado)
Cross cover (recessed track)

- A61L-786-01
- A61L-786-02
- A61L-786-03



Para /For: B29E- B29D-

Para /For: B29F- B29L- B29H- B29M- B29I-

Leva para carril empotrado
Cam for recessed track

- A61M-786-03



Leva para techo o tija
Cam for ceiling or stem pendant

- A61E-786-01
- A61E-786-02
- A61E-786-03



Cable de acero
Steel cable

- A61A-786-01 (1500mm)
- A61A-786-02 (1500mm)
- A61A-786-03 (1500mm)



Tija
Stem Pendant

- A61C-786-01 (1000mm)
- A61C-786-02 (1000mm)
- A61D-786-01 (1000mm)
- A61D-786-02 (1000mm)
- A61H-786-39

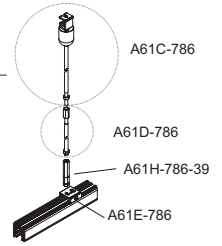

EJEMPLOS DE INSTALACIÓN — INSTALLATION EXAMPLES

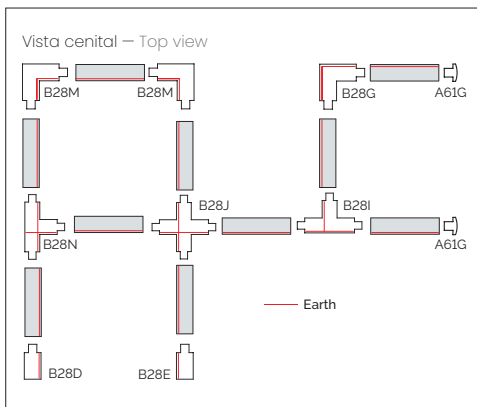

Herramienta para doblar conductores carril
Track conductor bending tool

A61N-786-00

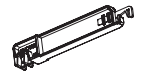

Corte carril a medida
uso herramienta especial
A61N-786-00



Video

Three-phase rail
cut to length use of
special tool A61N-786-00



Video

Acabado blanco, negro o gris — White, black or grey finish

exo
lighting



Decorativa de interior | Hospitality & Contract | Producción local

Exo reúne luminarias decorativas de interior con un fuerte carácter estético, pensadas para enriquecer proyectos residenciales, hoteleros y de restauración. El 80% de su catálogo se fabrica en España, priorizando materiales y proveedores locales, lo que permite reducir el impacto ambiental y ofrecer mayor capacidad de adaptación. Exo combina diseño, detalle y compromiso con el entorno, con una gama que permite desarrollos a medida para proyectos que buscan diferenciación y coherencia visual.

Indoor decorative | Hospitality & Contract | Local production

Exo brings together decorative indoor luminaires with strong aesthetic character, designed to enrich residential, hospitality, and restaurant projects. 80% of its range is manufactured in Spain, prioritising local materials and suppliers, which helps to reduce environmental impact and increase adaptability. Exo combines design, attention to detail, and environmental commitment, with a range that allows for bespoke developments in projects seeking visual coherence and differentiation.





CUSTOM LIGHTING

En Novolux Lighting contamos con talleres propios de fabricación y montaje, lo que nos permite crear luminarias decorativas a medida para proyectos.

Nos adaptamos a cualquier necesidad, trabajando con aluminio, madera, cristal, metacrilato, entre otros materiales. En el proceso de fabricación de lámparas de aluminio, realizamos corte láser, torneado, soldadura y baño de pintura. Para lámparas de madera, llevamos a cabo el corte, pintura con pistola, montaje, entre otros procesos. También fabricamos lámparas con diversos materiales y fibras naturales.

Además, tenemos capacidad, conocimiento y experiencia en la fabricación de lámparas big format. Somos también especialistas en la fabricación de pantallas a medida, con una amplia variedad de acabados y materiales, adaptándonos a cualquier tamaño o medida especial.

At Novolux Lighting we have our own manufacturing and assembly workshops, allowing us to create custom decorative lighting for projects.

We adapt to any requirement, working with materials such as aluminum, wood, glass, acrylic, among others. In the aluminum lamp manufacturing process, we employ laser cutting, turning, welding, and painting. For wooden lamps, we carry out cutting, spray painting, assembly, among other processes. We also manufacture lamps using various materials and natural fibers.

Additionally, we have the capability, knowledge, and experience in manufacturing large-format lamps. We are also specialists in the production of custom lampshades, offering a wide variety of finishes and materials, accommodating any size or special measurement.

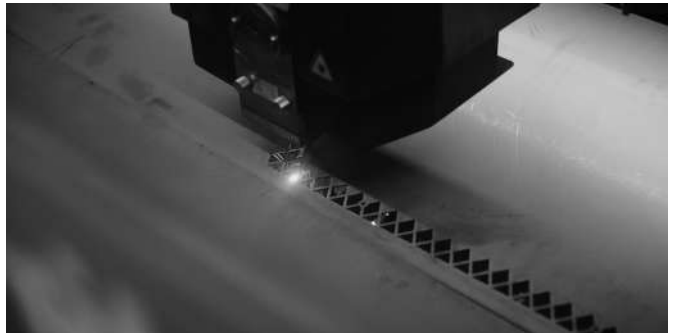

Wall Lights_

LANTERN



ACER

110V
240V
ACIP
20

Acabado blanco, negro, cobre, oro o verde envejecido – White, black, copper, gold or antique green finish

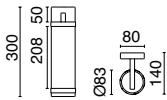

E27 LED/ Fluo max. 18W

- 1079A-G05XIA-01-27
- 1079A-G05XIA-02-27
- 1079A-G05XIA-37-27
- 1079A-G05XIA-47-27
- 1079A-G05XIA-AG-27

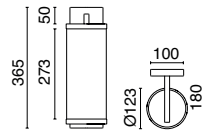

E27 LED/ Fluo max. 18W

- 1079B-G05XIA-01-27
- 1079B-G05XIA-02-27
- 1079B-G05XIA-37-27
- 1079B-G05XIA-47-27
- 1079B-G05XIA-AG-27



E27 LED/ Fluo max. 18W

- 1079A-G05XIA-01-29
- 1079A-G05XIA-02-29
- 1079A-G05XIA-37-29
- 1079A-G05XIA-47-29
- 1079A-G05XIA-AG-29



E27 LED/ Fluo max. 18W

- 1079B-G05XIA-01-29
- 1079B-G05XIA-02-29
- 1079B-G05XIA-37-29
- 1079B-G05XIA-47-29
- 1079B-G05XIA-AG-29





SIGN

by Nacho Timón



Acabado blanco, negro u oro mate – White, black or matt gold finish

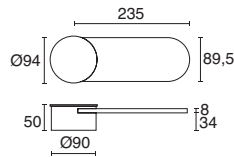
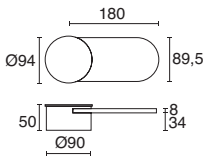

LED SMD 4,5W 3000K

- 1076A-L3105B-01
- 1076A-L3105B-02
- 1076A-L3105B-46

LED SMD 4,5W 3000K

- 1076B-L3105B-01
- 1076B-L3105B-02
- 1076B-L3105B-46

Diseño personalizable – Customisable design

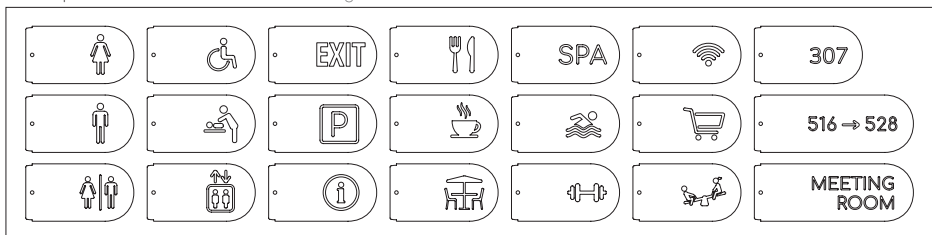



304

303

TEC

by Nacho Timón



Video



Acabado madera haya – Beech wood finish

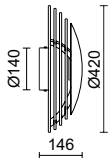

GX53 LED T2 10W 1200lm 3000K

■ 1073B-L3110A-50

P_410



P_348





EYE

by Nacho Timón

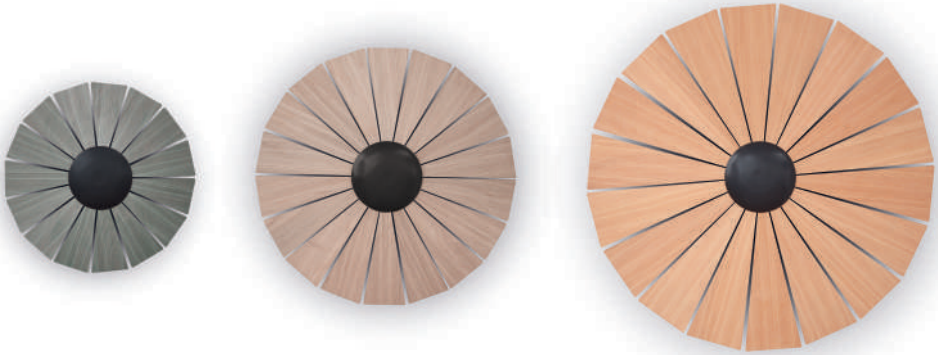

Acabado negro con aspas madera oscura, natural o clara
Black finish with dark wood, natural or light wood blades

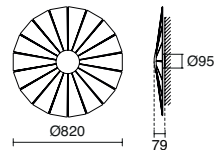
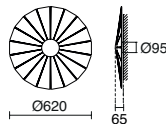
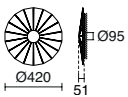

LED SMD 14W 1863lm 3000K

- 962A-L3114B-02-W1
- 962A-L3114B-02-W2
- 962A-L3114B-02-W3

LED SMD 21W 2794lm 3000K

- 962B-L3114B-02-W1
- 962B-L3114B-02-W2
- 962B-L3114B-02-W3

LED SMD 28W 3479lm 3000K

- 962C-L3114B-02-W1
- 962C-L3114B-02-W2
- 962C-L3114B-02-W3

-W1

-W2

-W3



Posibilidad de imprimir diseño personalizado
Possibility to print customised design





KRISTA

by Nacho Timón



Acabado negro con cristal verde, azul, fougé, sherry o salmón
Black finish with green, blue, fougé, sherry or salmon glass

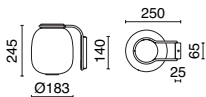

LED SMD AC 10W 830lm 2700K

- 1028G-L38RCB-02-05
- 1028G-L38RCB-02-06
- 1028G-L38RCB-02-FG
- 1028G-L38RCB-02-SH
- 1028G-L38RCB-02-SL





COFFEES & TEA		ESPRESSO COFFEES	
Coffee Latte	\$11.00	Coffee Latte	
Vanilla Latte	\$11.00	Vanilla Latte	
Coffee Latte	\$11.00	Coffee Latte	
Coffee Latte	\$11.00	Coffee Latte	
Coffee Latte	\$11.00	Coffee Latte	
Vanilla Latte	\$11.00	Vanilla Latte	

ICEE DRINKS

- 20oz Espresso
- 20oz Latte
- 20oz Smoothie
- 16oz Frappuccino
- 16oz Mocha
- 16oz Hot Chocolate
- 16oz Iced Tea



TOSCA

by Nacho Timón



Video



Acabado blanco, negro o azul – White, black or blue finish

Lamps P_859

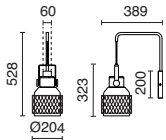

E27 Led/Fluo/Hal max. 60W

□ 956C-G05XIA-01

■ 956C-G05XIA-02

■ 956C-G05XIA-06

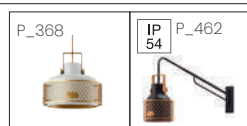



TANIA

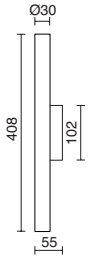

Acabado blanco, negro, cobre, oro o verde envejecido – White, black, copper, gold or antique green finish

2x LED SMD AC 4W 400lm 3000K

- 906D-L31HIB-01
- 906D-L31HIB-02
- 906D-L31HIB-37
- 906D-L31HIB-47
- 906D-L31HIB-AG

P_370



P_374



P_418



TANIA

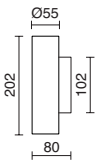

ACER



Acabado blanco, negro, cobre, oro o verde envejecido – White, black, copper, gold or antique green finish

2x GU10 Led/Hal. max. 50W

Lamps P_860

- 906A-G21XIA-01
- 906A-G21XIA-02
- 906A-G21XIA-37
- 906A-G21XIA-47
- 906A-G21XIA-AG

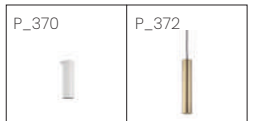

OXY



ACER



Acabado negro, cromado o oro – Black, chrome or gold finish

Lamps P_859

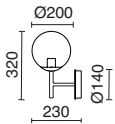

E27 Led / Fluo / Hal. max. 40W

■ 984F-G05XIA-02

▣ 984F-G05XIA-32

■ 984F-G05XIA-47



■ 984F-G05XIA-02-27

▣ 984F-G05XIA-32-27

■ 984F-G05XIA-47-27



OXY



Imitación alabastro
Imitation alabaster

ACER



110V
240V
AC



IP
40



Acabado blanco – White finish

Lamps P_859

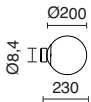

E27 Led / Fluo / Hal max. 40W

984P-G05X1A-01-27



E27 Led / Fluo / Hal max. 40W

984P-G05X1A-01-LB



P_362



P_360



DIAGONAL

by Nacho Timón

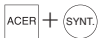

Acabado blanco, negro o cobre – White, black or copper finish

Lamps P_859

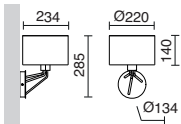

E27 Led max. 13W (Ø45)

- ○ 855E-G05XIA-01-SA
- ○ 855E-G05XIA-02-SB
- ● 855E-G05XIA-37-SM

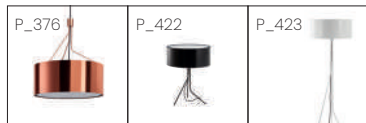

307



CLASSICAL



Acabado níquel satinado o oro con pantalla blanca o negra
Satin nickel or gold finish with white or black shade

Lamps P_859

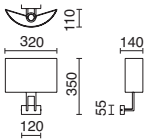

E27 Led/Fluo/Hal max 40W (Ø45)

□ ○ 986A-G05XIA-35-CA

● 986A-G05XIA-47-CB





AMSTERDAM



ACER

110V
240V
ACIP
20

Acabado níquel satinado con pantalla blanca, negra, marrón o beige
Satin nickel finish with white, black, brown or beige shade

Lamps P_859

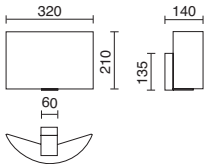

E27 (Ø45) Led / Fluo / Hal max. 40W

- ○ 909C-G05XIA-35-CA
- ● 909C-G05XIA-35-CB
- ● 909C-G05XIA-35-CG

COTTON



- ○ 908G-G05XIA-35-RA
- ● 908G-G05XIA-35-RB
- ○ 908G-G05XIA-35-RC

RIBBON
WRAP

P_426



P_426





CORA



Video



Acabado blanco o negro – White or black finish

Lamps P_859

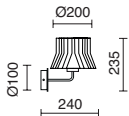

E27 Led/Fluo/Hal max. 40W (Ø45)

□ ○ 859D-G05XIA-01-RA

■ ● 859D-G05XIA-02-RB

P_386



P_428



P_428





NEMO



Acabado cuerpo blanco o negro y pantalla sintética blanca, beige, marrón o negro fabric
White or black body finish and synthetic white, beige, brown or black fabric shade finish

Lamps P_859

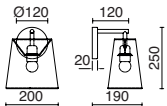

E27 Led / Fluo / Hal max. 40W

- 1017A-G05XIA-01-D1
- 1017A-G05XIA-01-D2
- 1017A-G05XIA-01-D3
- 1017A-G05XIA-02-D4





COMPACT



Acabado madera de haya con pantalla cotton white, eco beige o cotton earth
Beech wood finish with cotton white, eco beige or cotton earth shades

Lamps P_859

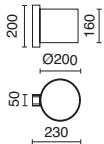

E27 Led / Fluo / Hal max. 40W (Ø45)

- 621C-G05XIA-50-CA
- 621C-G05XIA-50-DC
- 621C-G05XIA-50-CG





FIRENZE



Acabado níquel satinado u oro mate con pantalla blanca, negra o beige.
Satin nickel finish or matt gold with white, black or beige shade.

Lamps P_859

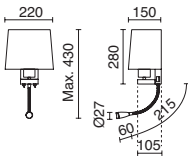

E27 Led / Fluo / Hal max. 60W + LED SMD 3W 240lm 3000K



- ☐ ○ 507E-Y05XIB-35-6ACA
- ◼ ● 507E-Y05XIB-35-6ACB
- ◻ ○ 507E-Y05XIB-35-6ACC

E27 Led / Fluo / Hal max. 60W + LED SMD 3W 240lm 3000K



- ☐ ○ 507A-Y05XIB-35-6ACA
- ◼ ● 507A-Y05XIB-35-6ACB
- ◻ ○ 507A-Y05XIB-35-6ACC
- ◻ ○ 507A-Y05XIB-46-6ACA
- ◼ ● 507A-Y05XIB-46-6ACB
- ◻ ○ 507A-Y05XIB-46-6ACC

E27 Led / Fluo / Hal max. 60W + LED SMD 3W 240lm 3000K



Type A Type A



- ☐ ○ 507F-Y05XIB-35-6ACA
- ◼ ● 507F-Y05XIB-35-6ACB
- ◻ ○ 507F-Y05XIB-35-6ACC
- ◻ ○ 507F-Y05XIB-46-6ACA
- ◼ ● 507F-Y05XIB-46-6ACB
- ◻ ○ 507F-Y05XIB-46-6ACC

P_320



P_388



P_430



P_431



FIRENZE



Acabado níquel satinado u oro mate con pantalla blanca, negra o beige.
Satin nickel finish or matt gold with white, black or beige shade.

Lamps P_859

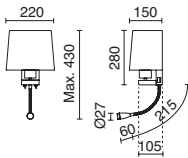

E27 Led / Fluó / Hal max. 60W + LED SMD 3W 240lm 3000K



- 507E-Y05XIB-35-7ACA
- 507E-Y05XIB-35-7ACB
- 507E-Y05XIB-35-7ACC

E27 Led / Fluó / Hal max. 60W + LED SMD 3W 240lm 3000K



- 507A-Y05XIB-35-7ACA
- 507A-Y05XIB-35-7ACB
- 507A-Y05XIB-35-7ACC
- 507A-Y05XIB-46-7ACA
- 507A-Y05XIB-46-7ACB
- 507A-Y05XIB-46-7ACC

E27 Led / Fluó / Hal max. 60W + LED SMD 3W 240lm 3000K



Type A Type A



- 507F-Y05XIB-35-7ACA
- 507F-Y05XIB-35-7ACB
- 507F-Y05XIB-35-7ACC
- 507F-Y05XIB-46-7ACA
- 507F-Y05XIB-46-7ACB
- 507F-Y05XIB-46-7ACC



FIRENZE

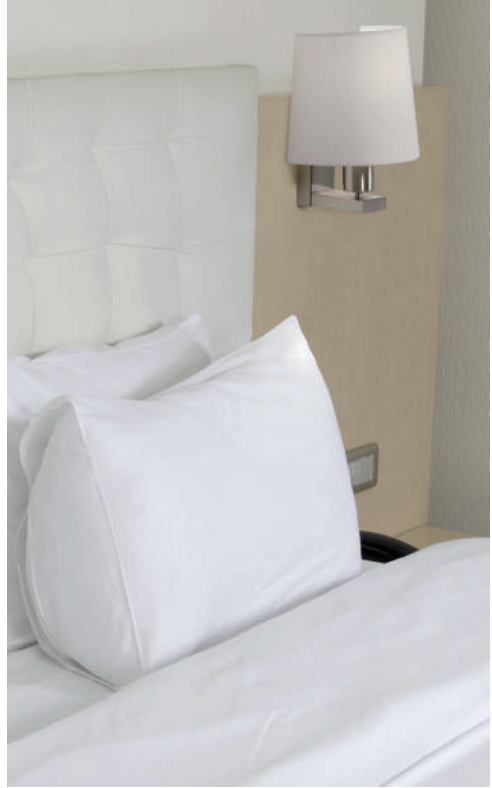

Acabado níquel satinado con pantalla blanca, negra o beige
Satin nickel finish with white, black or beige shade

Lamps P_859

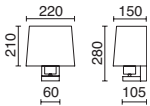

E27 Led / Fluo / Hal max. 60W



- 507B-G05XIA-35-6ACA
- 507B-G05XIA-35-6ACB
- 507B-G05XIA-35-6ACC



- 507B-G05XIA-35-7ACA
- 507B-G05XIA-35-7ACB
- 507B-G05XIA-35-7ACC



VALAN



Acabado blanco, moka o azul claro – White, mocha or light blue finish

Lamps P_859

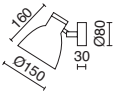

E27 Led / Fluo / Hal max. 60W (Ø45)

- 846B-G05XIA-01
- 846B-G05XIA-MK
- 846B-G05XIA-BL



ARM

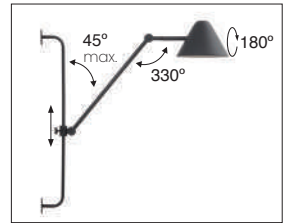

Acabado negro – Black finish

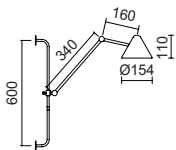
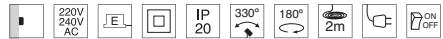

LED COB 5W 3000K 728lm

■ 935A-L3105B-02

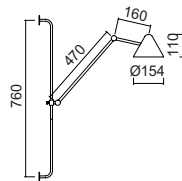

LED COB 5W 3000K 728lm

■ 935B-L3105B-02



MONTECARLO

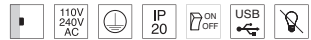
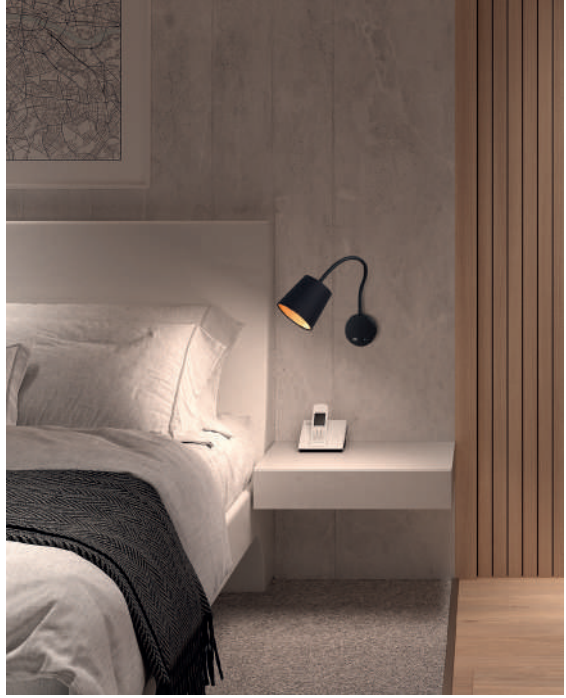

Acabado negro – Black finish

Lamps P_859

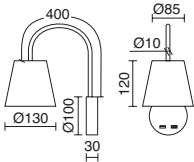

E27 Led / Fluo / Hal max. 60W (Ø45)

● 907B-G05XIA-02-CB



BOOK



Acabado negro – Black finish

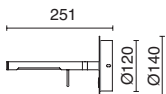

LED SMD 4W 3000K 280lm

■ 588A-L0104A-02

DIRK RANGE EXTENSION

by Novolux Technical Studio



Acabado blanco, negro o oro mate – White, black or matt gold finish

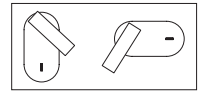

Doble posición
Double position

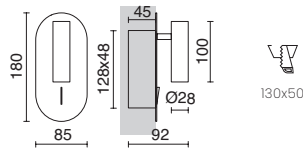
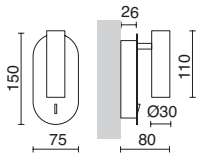

LED SMD 3W 200lm 3000K

- 704A-L0103B-01
- 704A-L0103B-02
- 704A-L0103B-02-46



LED SMD 3W 200lm 3000K

- 704B-L0103B-01
- 704B-L0103B-02
- 704B-L0103B-02-46

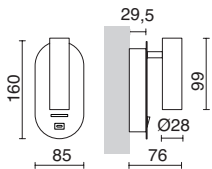

LED SMD 3W 200lm 3000K

- E □ 704C-L0103B-01
- E ■ 704C-L0103B-02
- E ■ 704C-L0103B-02-46





MINIMAL

by Novolux Technical Studio



Acabado blanco, negro o oro mate – White, black or matt gold finish



Nuevo acabado oro mate
New matt gold finish

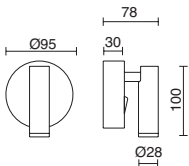

LED SMD 3W 200lm 3000K

□ 977A-L0103A-01

■ 977A-L0103A-02

◻ 977A-L0103A-02-46



SKIN

by Novolux Technical Studio



Acabado blanco, negro, rojo o marrón – White, black, red or brown finish

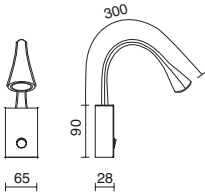

LED SMD 2W 160lm 3000K

- 955A-L0102A-01
- 955A-L0102A-02
- 955A-L0102A-07
- 955A-L0102A-14



WRIGHT
FRANK LLOYD WRIGHT
TEXTILES
1914
NEW URBAN HOUSING
HEATH FRENCH

SERENE

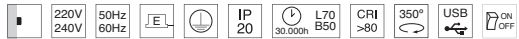

Acabado blanco o negro – White or black finish

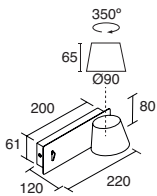

LED SMD 6W 732lm 3000K

- 1031C-L3106B-01
- 1031C-L3106B-02

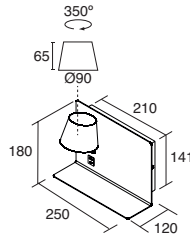

LED SMD 6W 732lm 3000K

- 1031A-L3106B-01
- 1031A-L3106B-02

Izquierda
Left 

- 1031B-L3106B-01
- 1031B-L3106B-02

Derecha
Right 

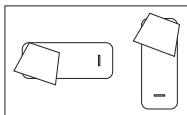

Doble posición
Double position





BALTIC



Acabado blanco o negro – White or black finish

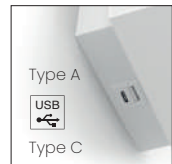
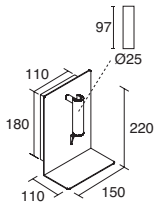

LED SMD 3W 25lm 3000K

□ 727G-L0103B-01

■ 727G-L0103B-02

TOSCANA



Acabado blanco, negro o niquel satinado – White, black or satin nickel finish

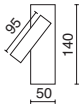

LED SMD 3W 200lm 3000K

- 842A-L0103B-01
- 842A-L0103B-02
- ◻ 842A-L0103B-35

LEIDEN



Acabado niquel satinado u oro mate – Satin nickel or matt gold finish

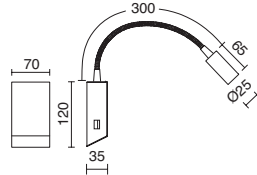
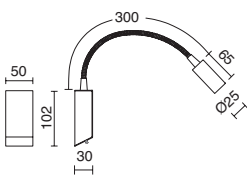

LED SMD 3W 240lm 3000K

- ◻ 517B-L0103B-35
- ◻ 517B-L0103B-46

LED SMD 3W 240lm 3000K

- ◻ 517E-L0103B-35
- ◻ 517E-L0103B-46



RETT

RANGE
EXTENSION

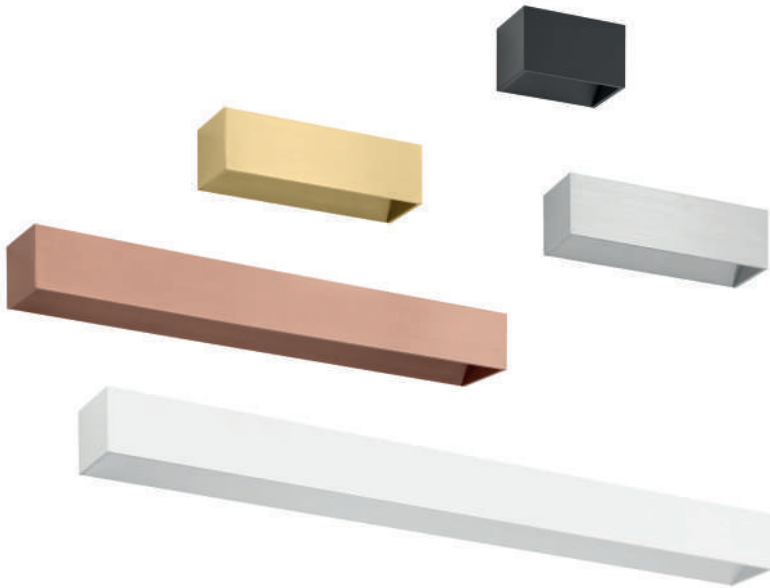

ALU



Acabado blanco, negro, bronce, aluminio cepillado u oro mate.
White, black, bronze, brushed aluminium or matt gold finish.

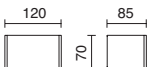

LED SMD 5W 450lm 3000K

- 504C-L0105B-01
- 504C-L0105B-02
- 504C-L0105B-BR
- 504C-L0105B-40
- 504C-L0105B-46

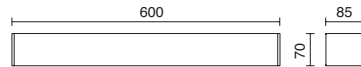

LED SMD 18W 1703lm 3000K

- 504B-L0118B-01
- 504B-L0118B-02
- 504B-L0118B-BR
- 504B-L0118B-40
- 504B-L0118B-46

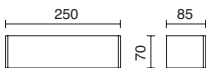

LED SMD 8W 790lm 3000K

- 504A-L0108B-01
- 504A-L0108B-02
- 504A-L0108B-BR
- 504A-L0108B-40
- 504A-L0108B-46

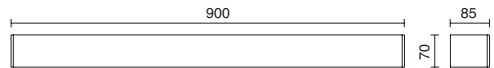

LED SMD 24W 2270lm 3000K

- 504B-L0124B-01
- 504B-L0124B-02
- 504B-L0124B-BR
- 504B-L0124B-40
- 504B-L0124B-46



7

COOPER



Acabado blanco, negro, bronce u oro mate – White, black, bronze or matt gold finish.

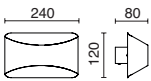

LED SMD 9W 850lm 3000K

- 987A-L0109B-01
- 987A-L0109B-02
- 987A-L0109B-BR
- 987A-L0109B-46



CIRCULAR



Acabado blanco o negro – White or black finish



LED SMD 9W 914lm 3000K

□ 988A-L0109B-01

■ 988A-L0109B-02

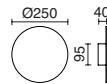

LED SMD 13W 1410lm 3000K

□ 988B-L0113B-01

■ 988B-L0113B-02

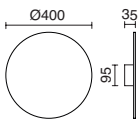

LED SMD 28W 3020lm 3000K

□ 988C-L0128B-01

■ 988C-L0128B-02

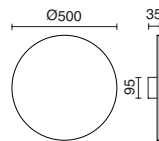

LED SMD 40W 4040lm 3000K

□ 988D-L0140B-01

■ 988D-L0140B-02

DENEBO



Acabado blanco – White finish

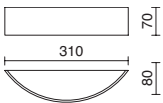

LED SMD 12W 1200lm 3000K

□ 695A-L0112B-01

IONA



Acabado blanco, negro o gris – White, black or grey finish

Lamps P_859-856

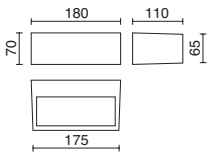

LED SMD 13W 1200lm 3000K

- 634A-L0113B-01
- 634A-L0113B-02
- 634A-L0113B-03



LED SMD 13W 1200lm 3000K

- 634B-L0113B-01
- 634B-L0113B-02
- 634B-L0113B-03



E27 (Ø45) Led / Fluo / Hal max. 40W

- 634C-G05XIA-01
- 634C-G05XIA-02
- 634C-G05XIA-03





625

627

628

629

630

BRICK



ALU

110V
240V

Acabado blanco, negro o aluminio cepillado – White, black or brushed aluminum finish.

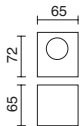

LED SMD 3W 165lm 3000K

- 412A-L0103B-01
- 412A-L0103B-02
- 412A-L0103B-40

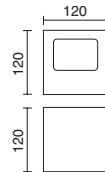
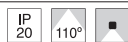

LED SMD 2x 5W 2x 325lm 3000K

- 412B-L01FIB-01
- 412B-L01FIB-02
- 412B-L01FIB-40

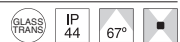

2x LED SMD 3W 165lm 3000K

- 412B-L01E2B-01
- 412B-L01E2B-02
- 412B-L01E2B-40

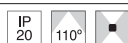



Pendant & Ceiling Lamps_

TEC

by Nacho Timón



Video

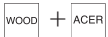

Acabado madera haya – Beech wood finish

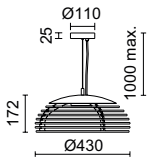

GX53 LED T2 10W 1200lm 3000K

■ I073C-L3110A-50





FISH

by Nacho Timón



Video



WOOD + ALU

110V 240V AC, LED, IP 20, 120°

Acabado blanco, negro o madera haya — White, black or beech wood finish

Posibilidad de regulacion
Possibility of regulation

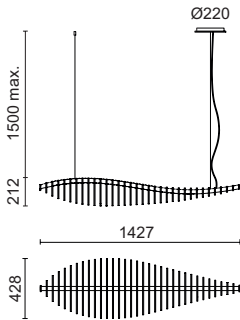

LED SMD 26W 2870lm 2700K

- 1013B-L3826A-01
- 1013B-L3826A-02
- 1013B-L3826A-50

LED SMD 26W 3170lm 4000K

- 1013B-L4026A-01
- 1013B-L4026A-02
- 1013B-L4026A-50





FISH

by Nacho Timón



Video

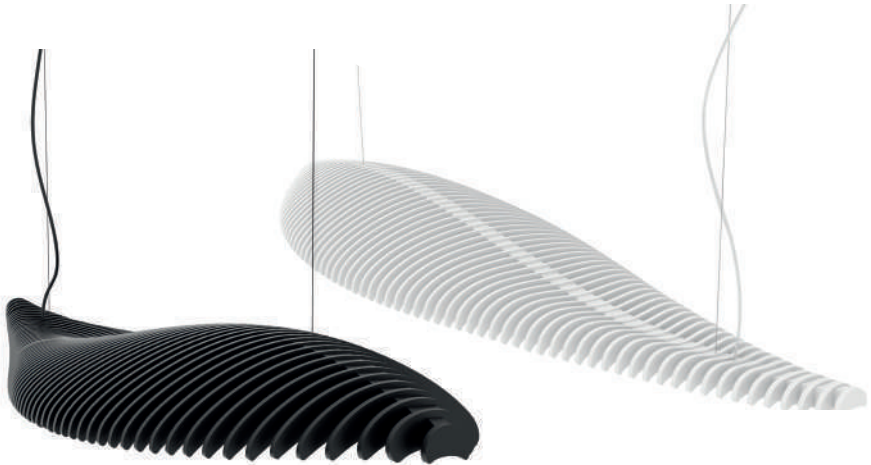

wood + ALU



220V
240V
AC



IP
20

120°

Acabado blanco, negro o madera haya — White, black or beech wood finish

Posibilidad de regulación
Possibility of regulation

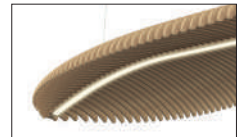
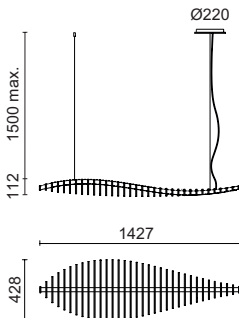

LED SMD 26W 2870lm **2700K**

- 1013A-L3826B-01
- 1013A-L3826B-02
- 1013A-L3826B-50

LED SMD 26W 3170lm **4000K**

- 1013A-L4026B-01
- 1013A-L4026B-02
- 1013A-L4026B-50

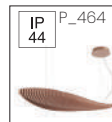



TWIST

by Nacho Timón



Video



WOOD



110V
240V
AC



IP
20



Acabado madera haya — Beech wood finish

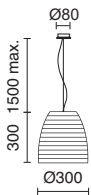

GX53 LED T2 6W 480lm 3000K

■ 945C-L3110A-50

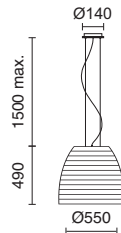

GX53 LED T2 10W 1200lm 3000K

■ 945D-L3110A-50

P_408





KRISTA

by Nacho Timón



Acabado negro con cristal verde, azul, fougé, sherry o salmón
Black finish with green, blue, fougé, sherry or salmon glass

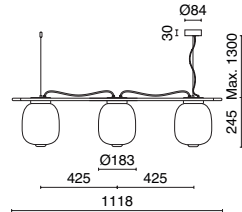
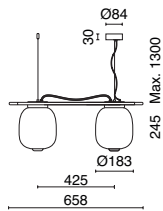
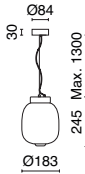

LED SMD AC 10W 830lm 2700K

- 1028A-L38RCB-02-05
- 1028A-L38RCB-02-06
- 1028A-L38RCB-02-FG
- 1028A-L38RCB-02-SH
- 1028A-L38RCB-02-SL

2x LED SMD AC 10W 830lm 2700K

- 1028B-L38RCB-02-05
- 1028B-L38RCB-02-06
- 1028B-L38RCB-02-FG
- 1028B-L38RCB-02-SH
- 1028B-L38RCB-02-SL

3x LED SMD AC 10W 830lm 2700K

- 1028C-L38RCB-02-05
- 1028C-L38RCB-02-06
- 1028C-L38RCB-02-FG
- 1028C-L38RCB-02-SH
- 1028C-L38RCB-02-SL





KRISTA

by Nacho Timón



Acabado negro con cristal verde, azul, fougé, sherry o salmón
 Black finish with green, blue, fougé, sherry or salmon glass

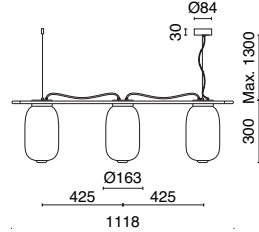
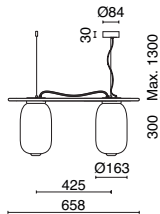
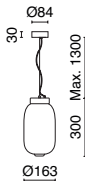

LED SMD AC 10W 830lm 2700K

- 1028D-L38RCB-02-05
- 1028D-L38RCB-02-06
- 1028D-L38RCB-02-FG
- 1028D-L38RCB-02-SH
- 1028D-L38RCB-02-SL

2x LED SMD AC 10W 830lm 2700K

- 1028E-L38RCB-02-05
- 1028E-L38RCB-02-06
- 1028E-L38RCB-02-FG
- 1028E-L38RCB-02-SH
- 1028E-L38RCB-02-SL

3x LED SMD AC 10W 830lm 2700K

- 1028F-L38RCB-02-05
- 1028F-L38RCB-02-06
- 1028F-L38RCB-02-FG
- 1028F-L38RCB-02-SH
- 1028F-L38RCB-02-SL



KRISTA

by Nacho Timón



Acabado negro con cristal verde, azul, fougé, sherry o salmón
Black finish with green, blue, fougé, sherry or salmon glass

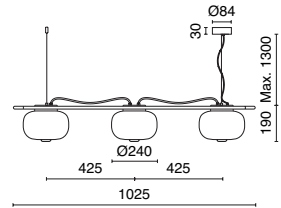
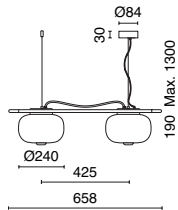
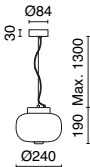

LED SMD AC 10W 830lm 2700K

- 1028H-L38RCB-02-05
- 1028H-L38RCB-02-06
- 1028H-L38RCB-02-FG
- 1028H-L38RCB-02-SH
- 1028H-L38RCB-02-SL

2x LED SMD AC 10W 830lm 2700K

- 1028H-L38RCB-02-05
- 1028H-L38RCB-02-06
- 1028H-L38RCB-02-FG
- 1028H-L38RCB-02-SH
- 1028H-L38RCB-02-SL

3x LED SMD AC 10W 830lm 2700K

- 1028J-L38RCB-02-05
- 1028J-L38RCB-02-06
- 1028J-L38RCB-02-FG
- 1028J-L38RCB-02-SH
- 1028J-L38RCB-02-SL



OXY



ACER



110V
240V
AC



IP
40



Acabado negro — Black finish

Lamps P_859

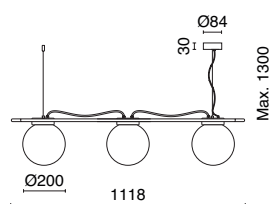
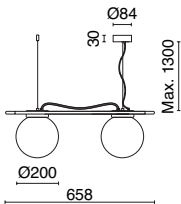

2x E27 Led / Fluo / Hal max. 40W

■ 984K-G05XIA-02-27



■ 984K-G05XIA-02-LB



3x E27 Led / Fluo / Hal max. 40W

■ 984L-G05XIA-02-27



■ 984L-G05XIA-02-LB

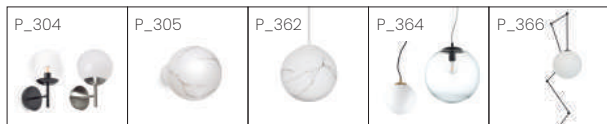



OXY



Imitación alabastro
Imitation alabaster

ACER



Acabado blanco — White finish

Lamps P_859

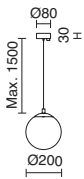

E27 Led / Fluo / Hal max. 40W

984M-G05XIA-01-27



984M-G05XIA-01-LB

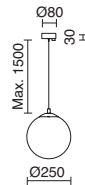

E27 Led / Fluo / Hal max. 40W

984N-G05XIA-01-27



984N-G05XIA-01-LB



Adaptador carril — Rail adapter

□ B17P-X33X2B-01

■ B17P-X33X2B-02

■ B17P-X33X2B-03





OXY



Acabado negro, cromado u oro — Black, chrome or gold finish

Lamps P_859

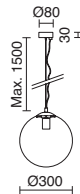
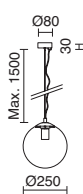
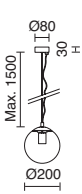

E27 Led / Fluó / Hal max. 40W

- 984A-G05XIA-02
- ▣ 984A-G05XIA-32
- 984A-G05XIA-47

E27 Led / Fluó / Hal max. 40W

- 984B-G05XIA-02
- ▣ 984B-G05XIA-32
- 984B-G05XIA-47

E27 Led / Fluó / Hal max. 60W

- 984C-G05XIA-02
- ▣ 984C-G05XIA-32
- 984C-G05XIA-47



- 984A-G05XIA-02-27
- ▣ 984A-G05XIA-32-27
- 984A-G05XIA-47-27

- 984B-G05XIA-02-27
- ▣ 984B-G05XIA-32-27
- 984B-G05XIA-47-27

- 984C-G05XIA-02-27
- ▣ 984C-G05XIA-32-27
- 984C-G05XIA-47-27

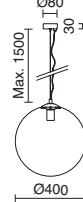
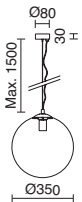

E27 Led / Fluó / Hal max. 60W

- 984D-G05XIA-02
- ▣ 984D-G05XIA-32
- 984D-G05XIA-47

E27 Led / Fluó / Hal max. 60W

- 984E-G05XIA-02
- ▣ 984E-G05XIA-32
- 984E-G05XIA-47



- 984D-G05XIA-02-27
- ▣ 984D-G05XIA-32-27
- 984D-G05XIA-47-27

- 984E-G05XIA-02-27
- ▣ 984E-G05XIA-32-27
- 984E-G05XIA-47-27



Adaptador carril — Rail adapter

- ▣ BI7P-X33X2B-01
- BI7P-X33X2B-02
- BI7P-X33X2B-03

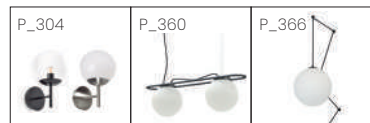



OXY



Acabado negro – Black finish

Lamps P_859

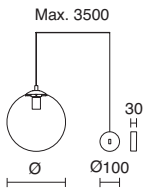

Ø300
E27 Led / Fluo / Hal max. 40W
■ 984H-G05XIA-02-27

Ø350
E27 Led / Fluo / Hal max. 40W
■ 984I-G05XIA-02-27

Ø400
E27 Led / Fluo / Hal max. 40W
■ 984J-G05XIA-02-27

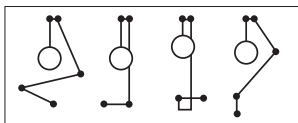

Numerosas opciones
Many options

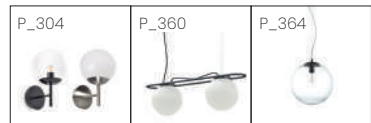

FLAKE



Acabado negro – Black finish

Lamps P_859

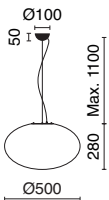

E27 Led / Fluo / Hal 15W

■ 1045A-G05XIA-02

TOSCA

by Nacho Timón



Video



ACER + ALU



110V
240V
AC



IP
20



Acabado blanco, negro o azul — White, black or blue finish

Lamps_P_859

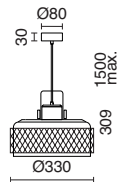
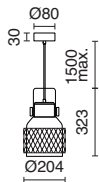

E27 Led/Fluo/Hal max. 60W

- 956A-G05XIA-01
- 956A-G05XIA-02
- 956A-G05XIA-06

E27 Led/Fluo/Hal max. 60W

- 956B-G05XIA-01
- 956B-G05XIA-02
- 956B-G05XIA-06

Adaptador carril — Rail adapter

- B17P-X33X2B-01
- B17P-X33X2B-02
- B17P-X33X2B-03

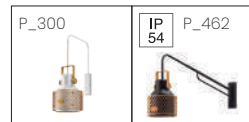



TANIA



Acabado blanco, negro, cobre, oro o verde envejecido
White, black, copper, gold or antique green finish

Lamps P_860



GUI0 Led/Hal max. 50W

- 906H-G2IXIA-01
- 906H-G2IXIA-02
- 906H-G2IXIA-37
- 906H-G2IXIA-47
- 906H-G2IXIA-AG

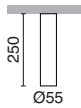

GUI0 Led/Hal max. 50W

- 906J-G2IXIA-01
- 906J-G2IXIA-02
- 906J-G2IXIA-37
- 906J-G2IXIA-47
- 906J-G2IXIA-AG

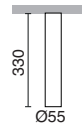

GUI0 Led/Hal max. 50W

- 906K-G2IXIA-01
- 906K-G2IXIA-02
- 906K-G2IXIA-37
- 906K-G2IXIA-47
- 906K-G2IXIA-AG

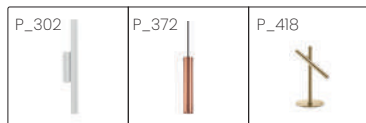



TANIA

ACER



110V
240V
AC



IP
20



Acabado blanco, negro, cobre, oro o verde envejecido
White, black, copper, gold or antique green finish

Lamps P_860

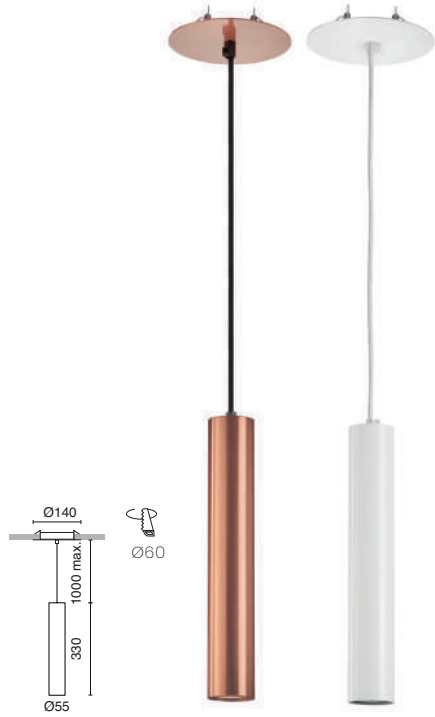

GU10 Led/Hal max. 50W

- 906B-G2IXIA-01
- 906B-G2IXIA-02
- 906B-G2IXIA-37
- 906B-G2IXIA-47
- 906B-G2IXIA-AG



GU10 Led/Hal max. 50W

- 906C-G2IXIA-01
- 906C-G2IXIA-02
- 906C-G2IXIA-37
- 906C-G2IXIA-47
- 906C-G2IXIA-AG



Adaptador carril — Rail adapter

- B17P-X33X2B-01
- B17P-X33X2B-02
- B17P-X33X2B-03



P_302

P_370

P_418





TANIA



Acabado blanco, negro, cobre, oro o verde envejecido
White, black, copper, gold or antique green finish

Lamps P_860

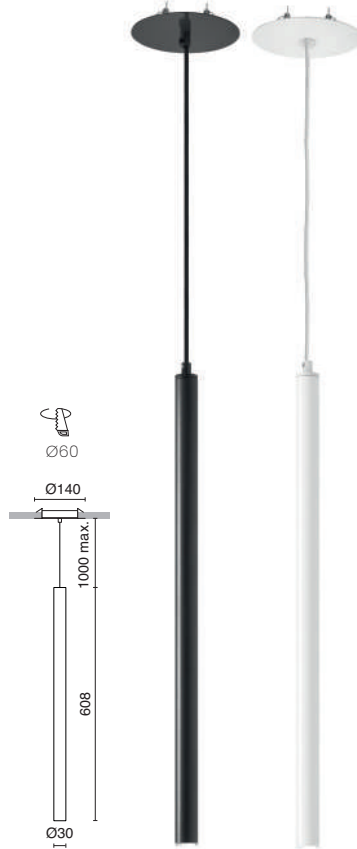
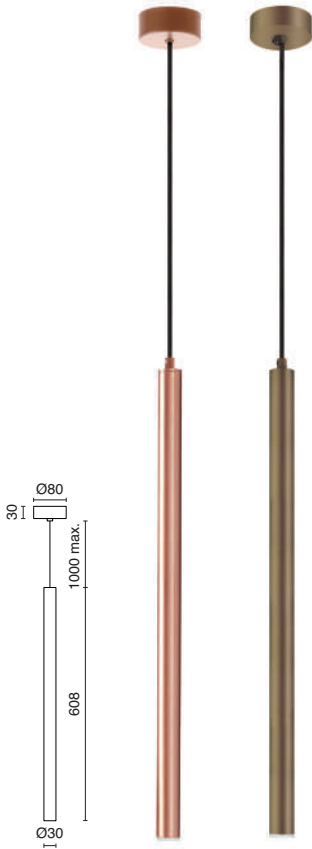

LED SMD AC 4W 400lm 3000K

- 906E-L3104B-01
- 906E-L3104B-02
- 906E-L3104B-37
- 906E-L3104B-47
- 906E-L3104B-AG



LED SMD AC 4W 400lm 3000K

- 906F-L3104B-01
- 906F-L3104B-02
- 906F-L3104B-37
- 906F-L3104B-47
- 906F-L3104B-AG



Adaptador carril — Rail adapter

- B17P-X33X2B-01
- B17P-X33X2B-02
- B17P-X33X2B-03





DIAGONAL

by Nacho Timón



Acabado blanco, negro o cobre — White, black or copper finish



Lamps P_859

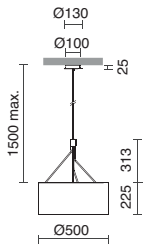

3x E27 Led. max. 13W

- ○ 855D-G05XIA-01-SA
- 855D-G05XIA-02-SB
- 855D-G05XIA-37-SM

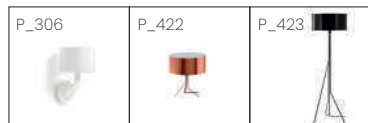

VALAN



Acabado blanco, moka o azul claro – White, mocha or light blue finish

Lamps P_859

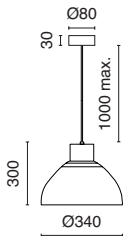

E27 Led / Fluo / Hal max. 60W

- 844A-G05X1A-01
- 844A-G05X1A-MK
- 844A-G05X1A-BL



NATURAL



Acabado negro con pantalla de mimbre claro o mimbre oscuro
Black finish with Shade light wicker or dark wicker

Lamps P_859

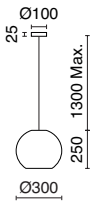

E27 Led max. 15W

- 1029A-G05X1A-02-M1
- 1029A-G05X1A-02-M2

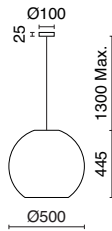

E27 Led max. 15W

- 1029B-G05X1A-02-M1
- 1029B-G05X1A-02-M2

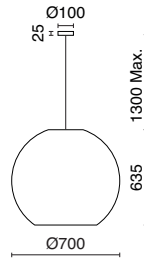

E27 Led max. 15W

- 1029C-G05X1A-02-M1
- 1029C-G05X1A-02-M2

Adaptador carril — Rail adapter

- B17P-X33X2B-01
- B17P-X33X2B-02
- B17P-X33X2B-03



Fabricado con materiales naturales susceptibles a variaciones de color y trama.
Made with natural materials susceptible to variations in color and pattern.

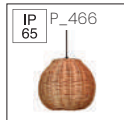



THAIS



Acabado negro con pantalla de raphia de Bali — Black finish with raphia de Bali shade

Lamps P_859

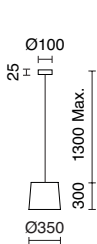

E27 Led max. 15W

■ ■ 985A-G05XIA-02-R1

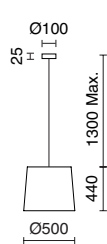

E27 Led max. 15W

■ ■ 985B-G05XIA-02-R1

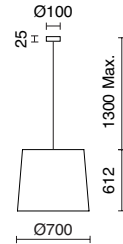

E27 Led max. 15W

■ ■ 985C-G05XIA-02-R1



Adaptador carril — Rail adapter

- B17P-X33X2B-01
- B17P-X33X2B-02
- B17P-X33X2B-03



Fabricado con materiales naturales susceptibles a variaciones de color y trama.
Made with natural materials susceptible to variations in color and pattern.





VIETNAM



Acabado negro con pantalla de mimbre claro o mimbre oscuro
Black finish with Shade light wicker or dark wicker

Lamps P_859

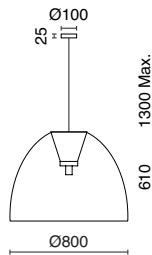
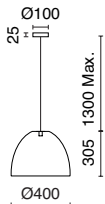

E27 Led max. 15W

- 1037A-G05X1A-02-M1
- 1037A-G05X1A-02-M2

E27 Led max. 15W

- 1037B-G05X1A-02-M1
- 1037B-G05X1A-02-M2

Adaptador carril — Rail adapter

- B17P-X33X2B-01
- B17P-X33X2B-02
- B17P-X33X2B-03



Fabricado con materiales naturales susceptibles a variaciones de color y trama.
Made with natural materials susceptible to variations in color and pattern.





MOLN



Acabado blanco — White finish

Lamps_P_859

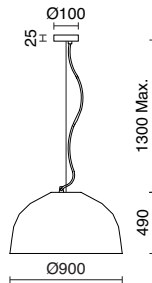
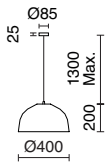

E27 Led max. 15W

3x E27 Led max. 15W

1030A-G05X1A-01-RA

1030B-G05X1A-01-RA

Posibilidad de customizar el acabado
Possibility to customise the finish

Adaptador carril — Rail adapter

- B17P-X33X2B-01
- B17P-X33X2B-02
- B17P-X33X2B-03

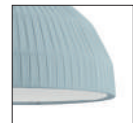



CORA



Video



Acabado blanco, negro o beige — White, black or beige finish

Lamps P_859

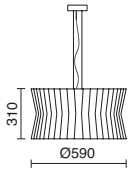

3x E27 Led/Fluo/Hal. max. 60W

- 859A-G05XIA-35-RA
- 859A-G05XIA-35-RB
- 859A-G05XIA-35-RC





FIRENZE



Suspensión beige o transparente con pantalla blanca, negra o beige
Beige or transparent pendant with white, black or beige shade

Lamps P_859

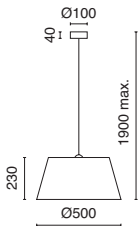

E27 Led / Fluo / Hal max. 60W

- 507G-G05XIA-09-2ACA
- 507G-G05XIA-09-2ACB
- 507G-G05XIA-09-2ACC

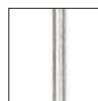

E27 Led / Fluo / Hal max. 60W

- 507G-G05XIA-29-2ACA
- 507G-G05XIA-29-2ACB
- 507G-G05XIA-29-2ACC

Adaptador carril — Rail adapter

- B17P-X33X2B-01
- B17P-X33X2B-02
- B17P-X33X2B-03





VORADA



Acabado pantalla Ribbon wrapped white, black o beige – Shade finish White, black or beige wrapped tape



LED COB AC 12W 1030lm 3000K

- 908A-L0112B-RA
- 908A-L0112B-RB
- 908A-L0112B-RC



LED SMD 25W 3540lm 3000K

- 908B-L0125B-RA
- 908B-L0125B-RB
- 908B-L0125B-RC



LED SMD 29W 4000lm 3000K

- 908C-L0129B-RA
- 908C-L0129B-RB
- 908C-L0129B-RC

Posibilidad de customizar el acabado
Possibility to customise the finish



VORADA



Acabado pantalla Ribbon wrapped white, black o beige – Shade finish White, black or beige wrapped tape

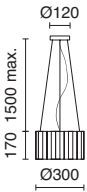

LED COB AC 12W 1030lm 3000K

- 908D-L0112B-RA
- 908D-L0112B-RB
- 908D-L0112B-RC

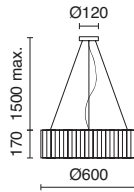

LED SMD 25W 3540lm 3000K

- 908E-L0125B-RA
- 908E-L0125B-RB
- 908E-L0125B-RC

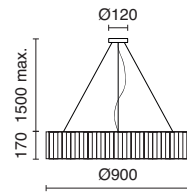

LED SMD 29W 4000lm 3000K

- 908F-L0129B-RA
- 908F-L0129B-RB
- 908F-L0129B-RC

Posibilidad de customizar el acabado
Possibility to customise the finish



FRED



Acabado blanco, negro o gris – White, black or grey finish

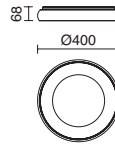
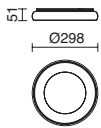

LED SMD 25W 1850lm 3000K

- 715A-L0125A-01
- 715A-L0125A-02
- 715A-L0125A-03



LED SMD 25W 2940lm 3000K

- 715B-L3135A-01
- 715B-L3135A-02
- 715B-L3135A-03

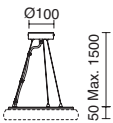

Accesorio necesario para suspensión
Necessary accessory for pendant

- A20A-715-01
- A20A-715-02
- A20A-715-03



Accesorio decorativo opcional para superficie
Optional decorative accessory for surface

- Ø298 Ø400
- A20B-715-01 A20C-715-01





VINYL



Acabado blanco con interior negro, oro, trama o madera haya – White finish with black, gold, weft or beech wood interior
 Trama decorativa interior personalizable – Customisable interior decorative pattern

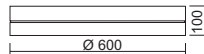
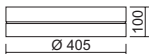

LED SMD 30W 3316lm 3000K

- ☐ ■ 1077A-L3132B-01-02
- ☐ ■ 1077A-L3132B-01-47
- ☐ ■ 1077A-L3132B-01-T1
- ☐ ■ 1077A-L3132B-01-50

LED SMD 36W 3980lm 3000K

- ☐ ■ 1077B-L3144B-01-02
- ☐ ■ 1077B-L3144B-01-47
- ☐ ■ 1077B-L3144B-01-T1
- ☐ ■ 1077B-L3144B-01-50



A TU ESTILO



ACER



110V
240V
AC



IP
20



Acabado blanco, negro o cromado – White, black or chrome finish

Lamps P_859

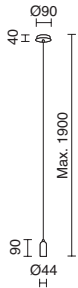

1x E27 Led / Vintage max. 60W

□ 717D-G05X1A-01

■ 717D-G05X1A-02

◻ 717D-G05X1A-32



3x E27 Led / Vintage max. 60W

□ 717E-G05X1A-01

■ 717E-G05X1A-02

◻ 717E-G05X1A-32

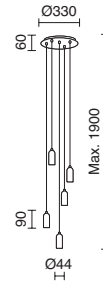

5x E27 Led / Vintage max. 60W

□ 717F-G05X1A-01

■ 717F-G05X1A-02

◻ 717F-G05X1A-32

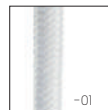

-01

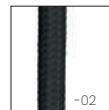

-02

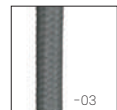

-03



BAGUET



ACER + WOOD



Acabado negro — Black finish

Lamps P_859

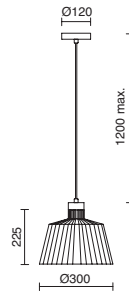
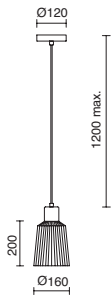

E27 Led / Fluó / Hal max. 42W

■ 685A-G05XIA-02

E27 Led / Fluó / Hal max. 42W

■ 685B-G05XIA-02

Adaptador carril — Rail adapter

□ B17P-X33X2B-01

■ B17P-X33X2B-02

■ B17P-X33X2B-03





ELGA



Acabado negro — Black finish

Lamps P_859

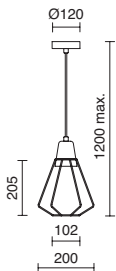

E27 Led / Fluo / Hal max. 60W

■ 684A-G05XIA-02

Adaptador carril — Rail adapter

□ B17P-X33X2B-01

■ B17P-X33X2B-02

■ B17P-X33X2B-03



VINTAGE



ACER



Acabado negro – Black finish

Lamps P_859

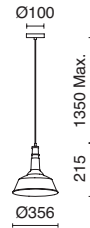
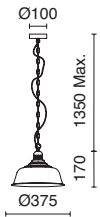

E27 Led / Fluo / Hal max. 60W

■ 620A-G05X1A-02

E27 Led / Fluo / Hal max. 60W

■ 585A-G05X1A-02

Adaptador carril – Rail adapter

- B17P-X33X2B-01
- B17P-X33X2B-02
- B17P-X33X2B-03



TANNA



ACER



110V
240V
AC



IP
20



Acabado negro — Black finish

Lamps P_859

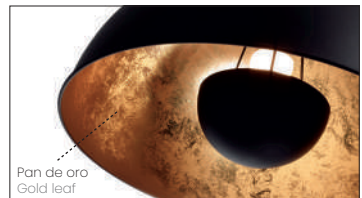
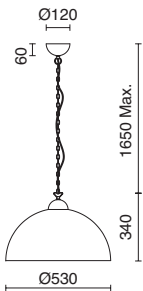

E27 Led / Fluo / Hal max. 60W

■ 618A-G05X1A-02

Adaptador carril — Rail adapter

□ B17P-X33X2B-01

■ B17P-X33X2B-02

■ B17P-X33X2B-03





EASY

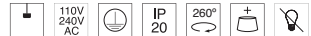

Brazo de níquel satinado con pantalla white, black o beige
Satin nickel arm finish with white, black or beige shade

Lamps P_859

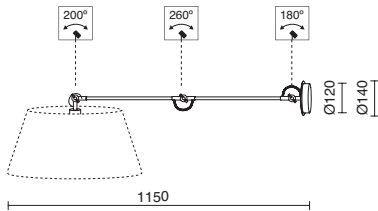

E27 Led / Fluo / Hal max. 60W

- ◻ ○ 595A-G05XIA-35-2ACA
- ◻ ● 595A-G05XIA-35-2ACB
- ◻ ○ 595A-G05XIA-35-2ACC



Floor & Table Lamps_

TWIST

by Nacho Timón



Video



Acabado madera haya – Beech wood finish



LED SMD T2 10W 1200lm 3000K

■ 945A-L3110A-50

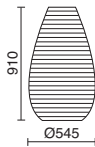

LED SMD T2 10W 1200lm 3000K

■ 945E-L3111A-50

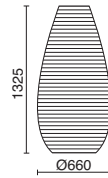

LED SMD T2 18W 2000lm 3000K

■ 945B-L3111A-50

P_354





TEC

by Nacho Timón



Video



Acabado madera haya – Beech wood finish

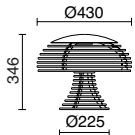

GX53 LED T2 10W 1200lm 3000K

■ 1073A-L3110A-50

P_294



P_348





GEOMETRICAL

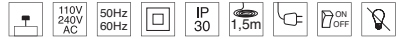

Acabado blanco o madera haya – White or beech wood finish

Lamps P_ 856

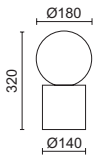

G9 LED Max. 5W

□ 1075A-H20XIA-01

■ 1075A-H20XIA-50



KRISTA

by Nacho Timón



Acabado negro con cristal verde, azul, fougé, sherry o salmón
 Black finish with green, blue, fougé, sherry or salmon glass

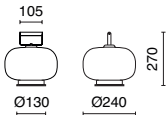

LED SMD AC 10W 830lm 2700K

- 1028K-L38RCB-02-05
- 1028K-L38RCB-02-06
- 1028K-L38RCB-02-FG
- 1028K-L38RCB-02-SH
- 1028K-L38RCB-02-SL



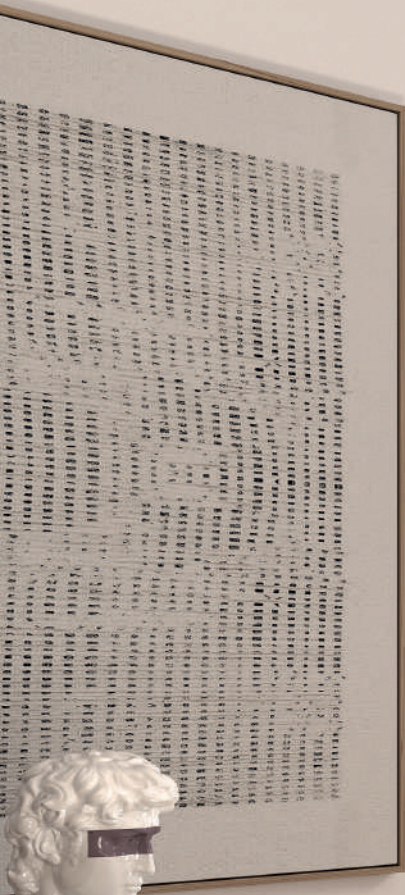

CERAMIC



Acabado blanco, negro u oro con pantalla cotton white, cotton grey o synthetic gold
White, black or gold finish with cotton white, cotton grey or synthetic gold shade

Lamps P_859

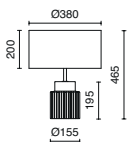

E27 Led max. 15W

- ○ 1033B-G05XIA-01-CA
- ● 1033B-G05XIA-02-CK
- ● 1033B-G05XIA-47-SG

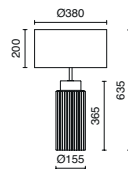

E27 Led max. 15W

- ○ 1033C-G05XIA-01-CA
- ● 1033C-G05XIA-02-CK
- ● 1033C-G05XIA-47-SG



TANIA

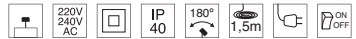

Acabado blanco, negro, cobre, oro o verde envejecido – White, black, copper, gold or antique green finish

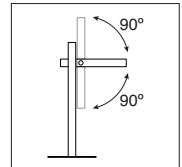
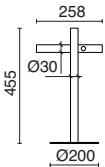

LED SMD AC 4W 400lm 3000K

- 906G-L3104B-01
- 906G-L3104B-02
- 906G-L3104B-37
- 906G-L3104B-47
- 906G-L3104B-AG

P_302

P_370

P_372



NEMO

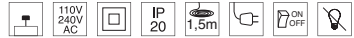

Pie blanco o negro con pantalla tejido sintético blanco, beige, marrón o negro fabric
 White or black body finish with synthetic white, beige, brown or black fabric shade finish.

Lamps
 P_855

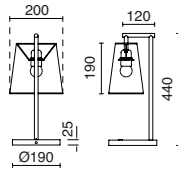
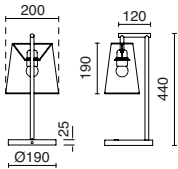

E27 Led / Fluó / Hal max. 40W

- ○ 1017B-G05XIA-01-D1
- ○ 1017B-G05XIA-01-D2
- ● 1017B-G05XIA-01-D3
- ● 1017B-G05XIA-02-D4

E27 Led / Fluó / Hal max. 40W

- ○ 1017D-G05XIA-01-D1
- ○ 1017D-G05XIA-01-D2
- ● 1017D-G05XIA-01-D3
- ● 1017D-G05XIA-02-D4



NEMO



ACER (SYNT.)



Pie blanco o negro con pantalla tejido sintético blanco, beige, marrón o negro fabric
White or black body finish with synthetic white, beige, brown or black fabric shade finish.

Lamps
P_855

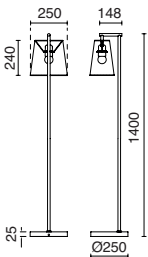

E27 Led / Fluo / Hal max. 40W

- 1017C-G05X1A-01-D1
- 1017C-G05X1A-01-D2
- 1017C-G05X1A-01-D3
- 1017C-G05X1A-02-D4

P_314



P_420



DIAGONAL

by Nacho Timón



Acabado blanco, negro o cobre – White, black or copper finish

Lamps P_859

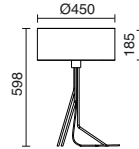
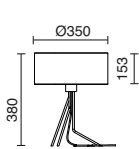

E27 Led max. 13W (Ø45)

- ○ 855C-G05X1A-01-SA
- ● 855C-G05X1A-02-SB
- ● 855C-G05X1A-37-SM

E27 Led max. 13W

- ○ 855B-G05X1A-01-SA
- ● 855B-G05X1A-02-SB
- ● 855B-G05X1A-37-SM

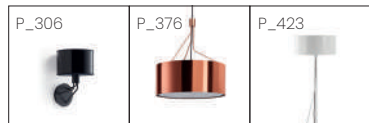

DIAGONAL

by Nacho Timón



ACER + SYNT. + PVC



Acabado blanco, negro o cobre – White, black or copper finish

Lamps P_859

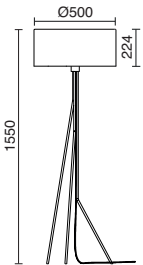

E27 Led max. 13W

- ○ 855A-G05X1A-01-SA
- ● 855A-G05X1A-02-SB
- ● 855A-G05X1A-37-SM

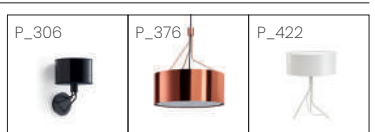

CLASSICAL



Acabado níquel satinado o oro con pantalla blanca o negra
Satin nickel or gold finish with white or black shade.

Lamps P_859

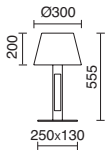

E27 Led/Fluo/Hal max. 60W

- ○ 986B-G05XIA-35-CA
- ● 986B-G05XIA-47-CB



E27 Led/Fluo/Hal max. 60W

- ○ 986C-G05XIA-35-CA
- ● 986C-G05XIA-47-CB



P_308





AMSTERDAM



Acabado blanco o negro con pantalla blanca, negra o marrón
Black or white finish with white, black or brown shade

Lamps P_859

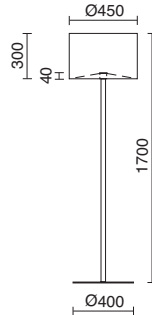
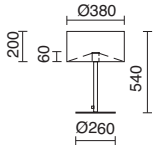

E27 Led / Fluo / Hal] max. 40W

- ○ 909B-G05XIA-01-9CCA
- ● 909B-G05XIA-01-9CCB
- ● 909B-G05XIA-01-9CCG
- ○ 909B-G05XIA-02-9CCA
- ● 909B-G05XIA-02-9CCB
- ● 909B-G05XIA-02-9CCG



E27 Led / Fluo / Hal] max. 40W

- ○ 909A-G05XIA-01-9BCA
- ● 909A-G05XIA-01-9BCB
- ● 909A-G05XIA-01-9BCG
- ○ 909A-G05XIA-02-9BCA
- ● 909A-G05XIA-02-9BCB
- ● 909A-G05XIA-02-9BCG



P_310





CORA



Video



Acabado blanco o negro – White or black finish

Lamps P_859

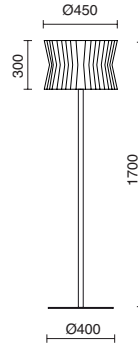
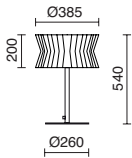

E27 Led/Fluo/Hal max. 40W (Ø45)

- ○ 859C-G05XIA-01-RA
- ● 859C-G05XIA-02-RB



E27 Led/Fluo/Hal max. 60W

- ○ 859B-G05XIA-01-RA
- ● 859B-G05XIA-02-RB





FIRENZE



Acabado níquel satinado con pantalla blanca, negra o beige
Satin nickel finish with white, black or beige shade

Lamps P_859

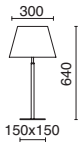

E27 Led / Fluo / Hal max. 60W



- 507D-G05X1A-35-6BCA
- 507D-G05X1A-35-6BCB
- 507D-G05X1A-35-6BCC

E27 Led / Fluo / Hal max. 60W



- 507D-G05X1A-35-7BCA
- 507D-G05X1A-35-7BCB
- 507D-G05X1A-35-7BCC



FIRENZE



Acabado níquel satinado con pantalla blanca, negra o beige
Satin nickel finish with white, black or beige shade

Lamps P_859

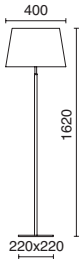

E27 Led / Fluo / Hal max. 60W



- ☐ ○ 507C-G05XIA-35-6CCA
- ☐ ● 507C-G05XIA-35-6CCB
- ☐ ○ 507C-G05XIA-35-6CCC

E27 Led / Fluo / Hal max. 60W



- ☐ ○ 507C-G05XIA-35-7CCA
- ☐ ● 507C-G05XIA-35-7CCB
- ☐ ○ 507C-G05XIA-35-7CCC



COMPACT



Acabado madera de haya con pantalla cotton white, eco beige o cotton earth
 Beech wood finish with cotton white, eco beige or cotton earth shade

Lamps P_859

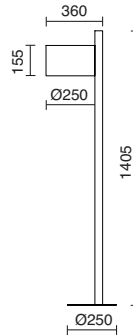
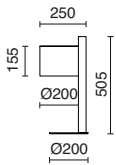

E27 Led / Fluo / Hal max. 40W (Ø45)

- 621D-G05XIA-50-CA
- 621D-G05XIA-50-DC
- 621D-G05XIA-50-CG



E27 Led / Fluo / Hal max. 40W

- 621E-G05XIA-50-CA
- 621E-G05XIA-50-DC
- 621E-G05XIA-50-CG



P_316





WOOD



Pie de madera de haya con pantalla cotton white, eco beige o cotton earth
Beech wood finish with cotton white, eco beige or cotton earth shade

Lamps P_859

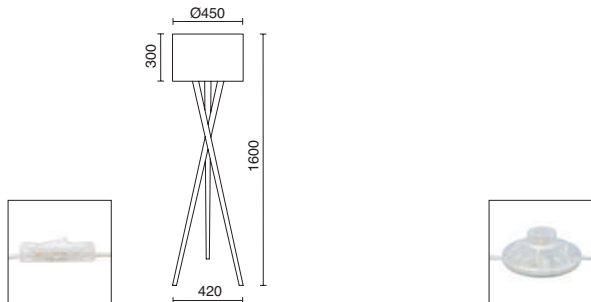
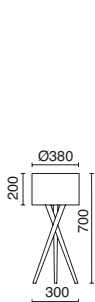

E27 Led / Fluo / Hal max. 60W

- 621B-G05X1A-50-9CCA
- 621B-G05X1A-50-9CDC
- 621B-G05X1A-50-9CCG



E27 Led / Fluo / Hal max. 60W

- 621A-G05X1A-50-9BCA
- 621A-G05X1A-50-9BDC
- 621A-G05X1A-50-9BCG





KARA



Pie de madera de haya o negra con pantalla cotton white, negra, eco beige o cotton earth
 Beech wood or black finish with cotton white, black, eco beige or cotton earth shade

Lamps P_859

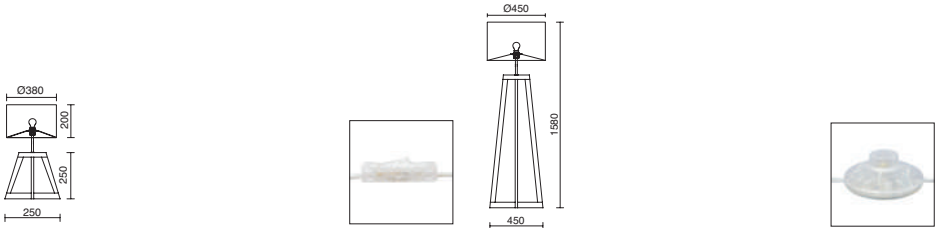

E27 Led / Fluo / Hal max. 40W

- ○ 703B-G05XIA-02-9CCA
- ● 703B-G05XIA-02-9CCB
- ● 703B-G05XIA-02-9CDC
- ● 703B-G05XIA-02-9CCG
- ○ 703B-G05XIA-50-9CCA
- ● 703B-G05XIA-50-9CCB
- ● 703B-G05XIA-50-9CDC
- ● 703B-G05XIA-50-9CCG



E27 Led / Fluo / Hal max. 60W

- ○ 703A-G05XIA-02-9BCA
- ● 703A-G05XIA-02-9BCB
- ● 703A-G05XIA-02-9BDC
- ● 703A-G05XIA-02-9BCG
- ○ 703A-G05XIA-50-9BCA
- ● 703A-G05XIA-50-9BCB
- ● 703A-G05XIA-50-9BDC
- ● 703A-G05XIA-50-9BCG





TAICHI



Acabado blanco o negro – White or black finish

Lamps P_859

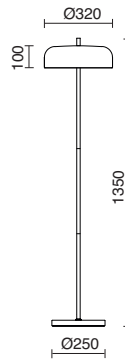
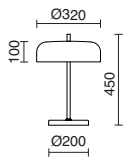

2x E27 (Ø45) Led / Fluo / Hal max. 40W

- 992A-G04XIA-01
- 992A-G04XIA-02



2x E27 (Ø45) Led / Fluo / Hal max. 40W

- 992B-G04XIA-01
- 992B-G04XIA-02





SINTRA



Acabado negro con pantalla cotton white – Black finish with cotton white shade

Lamps P_859

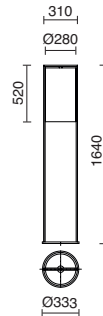
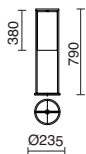

E27 Led / Fluo / Hal. max. 40W

■ ○ 917B-G05XIA-02-CA

E27 Led / Fluo / Hal. max. 60W

■ ○ 917A-G05XIA-02-CA



MANTIS



Acabado blanco – White finish

Lamps P_859

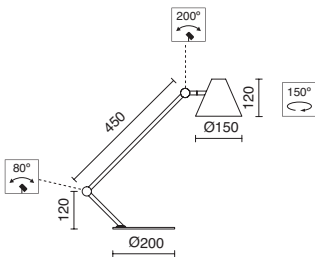

E27 (Ø45) Led / Fluo / Hal max. 40W

□ 990A-G04XIA-01



VALAN

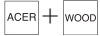

Acabado blanco, mocha o azul claro – White, mocha or light blue finish

Lamps P_859

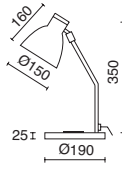
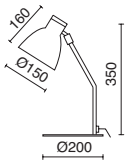

E27 Led / Fluo / Hal max. 60W (Ø45)

- 846C-G05XIA-01
- 846C-G05XIA-MK
- 846C-G05XIA-BL

E27 Led / Fluo / Hal max. 60W (Ø45)

- 846D-G05XIA-01
- 846D-G05XIA-MK
- 846D-G05XIA-BL



P_321



P_377



MONTECARLO



Acabado negro – Black finish

Lamps P_859

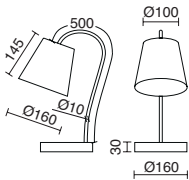

E27 Led / Fluo / Hal max. 60W (Ø45)

● 907A-G05XIA-02-CB



Bath Lights_

TILT



Acabado blanco o negro — Black or white finish

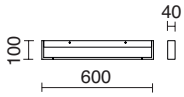

LED SMD 18W 2165lm 4000K

- 959A-L0218B-01
- 959A-L0218B-02

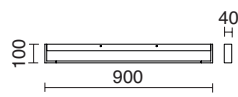

LED SMD 30W 3745lm 4000K

- 959B-L0230B-01
- 959B-L0230B-02





LIGHTS

BLIZZARD



Acabado cromado – Chrome finish

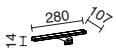

LED SMD AC 6W 457lm 4000K

970A-L0206B-32

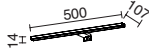

LED SMD AC 8W 568lm 4000K

970B-L0208B-32

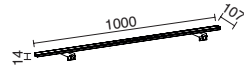

LED SMD AC 15W 1265lm 4000K

970D-L0215B-32

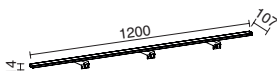

LED SMD AC 18W 1532lm 4000K

970E-L0218B-32

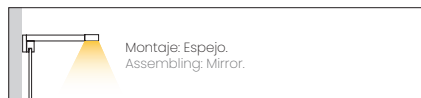



SLEET

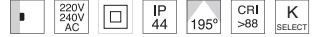

Acabado cromado – Chrome finish
Montaje a pared – Assembling to wall

3 temperaturas de color con pulsación directa, sin memoria.
3 color temperatures with direct pulse, no memory.

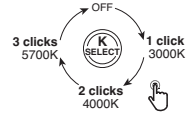
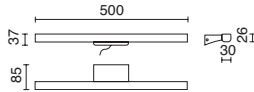
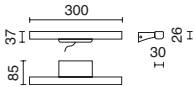

LED SMD AC 6W

■ 972D-L4106B-32

K SELECT	3000K	408lm
	4000K	473lm
	5700K	474lm

LED SMD AC 8W

■ 972E-L4108B-32

K SELECT	3000K	545lm
	4000K	614lm
	5700K	633lm

SHEID



Acabado cromado – Chrome finish

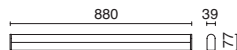
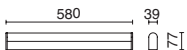

LED SMD 10W 1505lm 3000K

■ 513A-L0109B-32

LED SMD 18W 3125lm 3000K

■ 513B-L0118B-32



Ceiling Fans_

MISTRAL



Acabado blanco o negro con aspas de madera blanca, negra, arce o nogal
 Black or white finish with white, black, maple or walnut wood blades

Max. 235m³/min.
 Max. 48dB

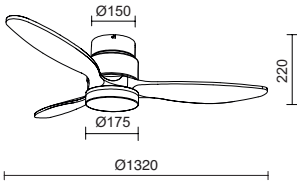

K SELECT	2700K	1420lm
	3200K	1480lm
	4000K	1500lm

LED SMD 24W 35W max. (139/150/179/185/213/225 rpm)

- 1074B-W4135B-01-01
- 1074B-W4135B-01-57
- 1074B-W4135B-01-59

- 1074B-W4135B-02-02
- 1074B-W4135B-02-57
- 1074B-W4135B-02-59

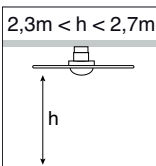
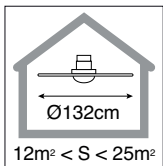

Altura min./max. recomendada desde el suelo.
 Min./max. recommended height from the ground.



MISTRAL



Acabado blanco o negro con aspas de madera blanca, negra, arce o nogal
Black or white finish with white, black, maple or walnut wood blades

Max. 235m³/min.
Max. 48dB

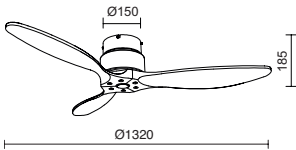

35W max. (139/150/179/185/213/225 rpm)

- 1074A-VX35B-01-01
- 1074A-VX35B-01-57
- 1074A-VX35B-01-59

- 1074A-VX35B-02-02
- 1074A-VX35B-02-57
- 1074A-VX35B-02-59

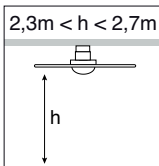
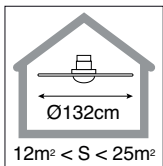

Altura min./max. recomendada desde el suelo.
Min./max. recommended height from the ground.

MISTRAL

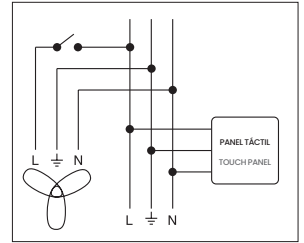

Panel táctil sin cables...Wireless touch panel

CONT.I074B

• Control centralizado de múltiples ventiladores

Un único panel puede gestionar más de 100 ventiladores en una misma estancia, con un alcance de control de entre 6 y 8 metros.

• Instalación sencilla

Solo requiere conexión eléctrica estándar (fase, neutro y tierra). No necesita configuraciones adicionales.

• Control desde varios puntos

Hasta 3 paneles táctiles pueden controlar el mismo ventilador de forma simultánea, facilitando el acceso desde diferentes ubicaciones.

• Emparejamiento flexible

Posibilidad de vincular uno o varios ventiladores a un mismo panel, individualmente o todos a la vez (dentro del radio de alcance).

• Sistema inalámbrico completo

Funciona mediante tecnología RF (radiofrecuencia), eliminando la necesidad de cableado entre dispositivos.

• Centralised control of multiple fans

A single panel can control over 100 fans within the same room, with a range of 6 to 8 metres.

• Simple installation

Requires only a standard electrical connection (live, neutral and earth). No additional configuration is needed.

• Multi-point control

Up to three touch panels can control the same fan simultaneously, allowing access from different locations.

• Flexible pairing

One or several fans can be paired to a single panel individually or all at once (within range).

• Fully wireless system

Operates via RF technology, eliminating the need for wiring between devices.



Cuando se controlan varios ventiladores a la vez, puede haber un ligero desfase en la respuesta de encendido/apagado, ya que la señal RF no se recibe exactamente al mismo tiempo por todos los dispositivos.

When controlling multiple fans simultaneously, there may be a slight delay in the on/off response, as not all devices receive the RF signal at exactly the same time.



Para evitar el encendido automático tras una caída de tensión, se recomienda conectar el ventilador al mismo interruptor que controla la iluminación de la sala.

To avoid automatic activation after a power outage, we recommend connecting the fan to the same switch that controls the room's lighting.

Decorative Outdoor_

TOSCA

by Nacho Timón



ACER + ALU



Acabado blanco, negro o azul — White, black or blue finish

Lamps P_859

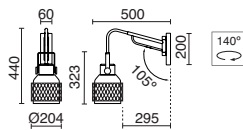

E27 Led/Fluo/Hal max. 60W

- 956D-G05XIA-01
- 956D-G05XIA-02
- 956D-G05XIA-06

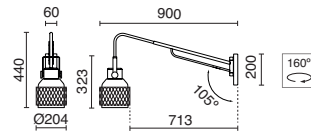

E27 Led/Fluo/Hal max. 60W

- 956E-G05XIA-01
- 956E-G05XIA-02
- 956E-G05XIA-06

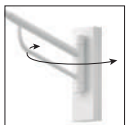



FISH

by Nacho Timón



wood + ALU



Acabado madera iroko – Iroko wood finish

Posibilidad de regulación
Possibility of regulation

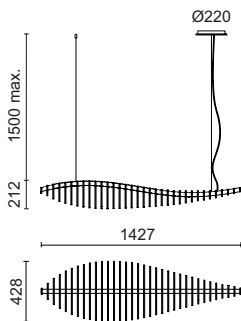

LED SMD 26W 2870lm 2700K

1013B-L3826A-IR





NATURAL



Acabado negro con pantalla de mimbre claro o mimbre oscuro
Black finish with Shade light wicker or dark wicker

Lamps P_859

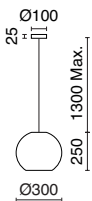

E27 Led max. 15W

- 1029D-G05X1A-02-M1
- 1029D-G05X1A-02-M2

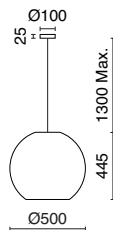

E27 Led max. 15W

- 1029E-G05X1A-02-M1
- 1029E-G05X1A-02-M2

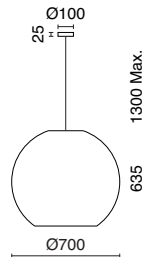

E27 Led max. 15W

- 1029F-G05X1A-02-M1
- 1029F-G05X1A-02-M2



IP 20 P_378

Fabricado con materiales naturales
susceptibles a variaciones de color y trama.
Made with natural materials susceptible
to variations in color and pattern.





THAIS



Florón negro con pantalla de raphia de Bali – Black finish with raffia de Bali shade

Lamps P_859



E27 Led max. 15W

■ 985D-G05XIA-02-RI 228€

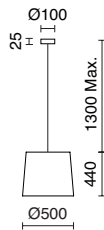

E27 Led max. 15W

■ 985E-G05XIA-02-RI 260€

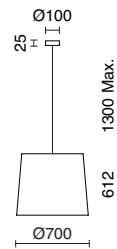

E27 Led max. 15W

■ 985F-G05XIA-02-RI 505€



IP 20 P_380

Fabricado con materiales naturales susceptibles a variaciones de color y trama.
Made with natural materials susceptible to variations in color and pattern.





VIETNAM



Acabado negro con pantalla de mimbre claro o mimbre oscuro
Black finish with Shade light wicker or dark wicker

Lamps P_859

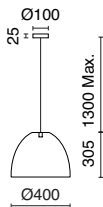

E27 Led max. 15W

- 1037C-G05X1A-02-M1
- 1037C-G05X1A-02-M2

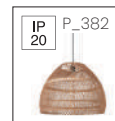

Fabricado con materiales naturales
susceptibles a variaciones de color y trama.
Made with natural materials susceptible
to variations in color and pattern.



NELL

by Novolux Technical Studio



ALU + INOX + RATAN 

Acabado grafito – Graphite finish

Lamps P_859

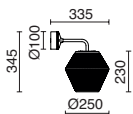

LED COB AC 6W 515lm 3000K

■ 857H-L3106B-58

NELL

by Novolux Technical Studio

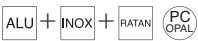

Acabado grafito – Graphite finish

Lamps P_859

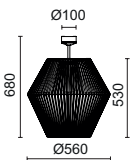

E27 LED 15W max.

■ 857D-G05X1A-58

NELL

by Novolux Technical Studio

ALU + INOX + RATAN 



Acabado grafito – Graphite finish



LED SMD AC 2W 200lm 3000K

■ 857C-L3102L-58



ALU + INOX + RATAN 



Acabado grafito – Graphite finish

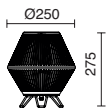

LED COB AC 6W 515lm 3000K

■ 857C-L3106B-58

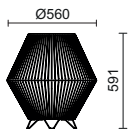

Ø560
E27 LED 15W max.

■ 857B-G05XIA-58

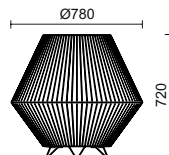

Ø780
E27 LED 15W max.

■ 857A-G05XIA-58



Lamps P_859



Dopo
lighting

Exterior funcional | Stock inmediato | Calidad-precio

Dopo ofrece soluciones accesibles y duraderas para la iluminación exterior de espacios residenciales y proyectos hospitality. Su catálogo se caracteriza por una excelente relación calidad-precio y una disponibilidad sobresaliente: el 95% de los productos están listos para entrega en 48 horas. Esta gama responde con agilidad a proyectos que requieren funcionalidad, estética cuidada y resistencia, sin renunciar a la eficiencia operativa.

Functional outdoor | Immediate stock | Value for money

Dopo offers accessible, durable solutions for outdoor lighting in residential and hospitality projects. Its catalogue stands out for its excellent price-performance ratio and outstanding availability: 95% of products are ready for delivery within 48 hours. This range responds quickly to projects that require functionality, refined aesthetics and durability – without compromising operational efficiency.



Wall Lights_

FLAT



Acabado antracita – Anthracite finish

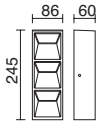

LED SMD 6W 900lm 3000K

■ 1086A-L3105A90-04





17

ORBITA



Acabado antracita – Anthracite finish

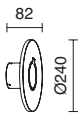

LED SMD 8W 1300lm 3000K

■ 1054A-L3110B-04

P_590





MURA



Acabado blanco o negro – White or black finish

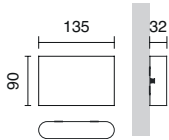

LED SMD 2x 2,5W

□ 1034A-L4106B-01

■ 1034A-L4106B-02

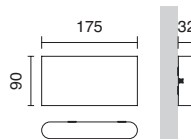

LED SMD 2x 4W

□ 1034B-L4110B-01

■ 1034B-L4110B-02

K SELECT	2700K	2x 370lm
	3200K	2x 410lm
	4000K	2x 430lm

K SELECT	2700K	2x 525lm
	3200K	2x 600lm
	4000K	2x 700lm



EVEN

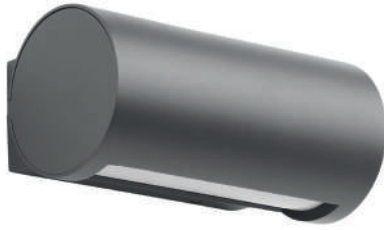

Acabado antracita – Anthracite finish

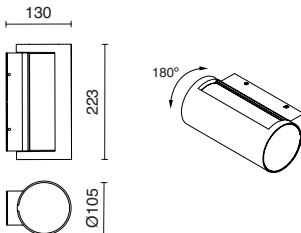

LED SMD 11W 1500lm 3000K

■ 1050A-L3113B-04



IKONA



Acabado negro – Black finish

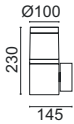

LED SMD 7W

■ 1072A-L4108BBF-02

K SELECT	3000K	790lm
	4000K	845lm

P_592



CROMA



Acabado blanco o negro – White or black finish

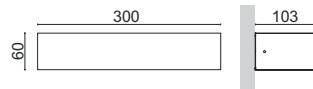
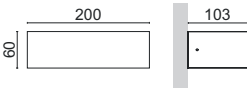

LED SMD 9W

- 1071A-L4110BBF-01
- 1071A-L4110BBF-02

K SELECT	2700K	1230lm
	3200K	1350lm
	4000K	1530lm

LED SMD 14W

- 1071B-L4115BBF-01
- 1071B-L4115BBF-02

K SELECT	2700K	1830lm
	3200K	1900lm
	4000K	2040lm

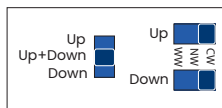

SELECT OPTION	K SELECT
<input type="checkbox"/> UP	2700k/3200k /4000k
<input type="checkbox"/> UP+DOWN	2700k/3200k/4000k + 2700k/3200k/4000k
<input type="checkbox"/> DOWN	2700k/3200k/4000k

SIMIL



Acabado antracita – Anthracite finish

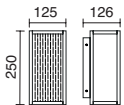

Imitación madera
Wood imitation



LED SMD 6,5W 1020lm 3000K

■ 1027A-L3107BX0-04

P_594





LUG

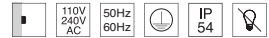

Acabado blanco o antracita – White or anthracite finish

Lamps P_859



E27 Led/Fluo 18W max.

- 1015A-G05XIA-01
- 1015A-G05XIA-04

P_596



LOOP

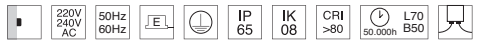

Acabado negro – Black finish

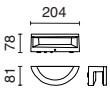

LED SMD 9,5W 1295lm **3000K**

■ 982A-L3109A-02

LED SMD 9,5W 1405lm **4000K**

■ 982A-L3309A-02



ADAY

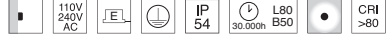

Acabado antracita – Anthracite finish

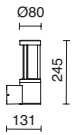

LED SMD 10W 1300lm 3000K

■ 848A-L0109A-04



AVON



Acabado antracita – Anthracite finish

Lamps P_859

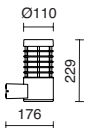

E27 Led/Fluo 15W max.

■ 1016A-G05XA-04





CASTELLO



ALU (GLASS MAT)

Acabado antracita – Anthracite finish

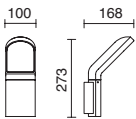

LED SMD 10W 1200lm 3000K

■ 534A-L0109A-04

110V
240V
AC

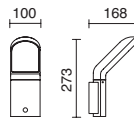

LED SMD 10W 1200lm 3000K

■ 534C-L0109B-04



Regulación de:

- Distancia: 0>8 m.
- Tiempo de activación: de 5 seg. a 8 min.
- Intensidad de la luz: 10 - 2000lux
- Ángulo de detección: 100°

Adjustable:

- Distance: 0>8 m.
- Activation time: from 5 sec. to 8 min.
- Light intensity: 10 - 2000lux
- Detection angle: 100°

P_605





ARLEN



Acabado antracita – Anthracite finish

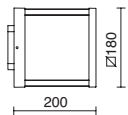

LED COB 12W 1300lm 3000K

■ 791A-L0112A-04

P_608





BEAM



Acabado blanco, negro, antracita o marrón óxido – White, black, anthracite or oxide brown finish

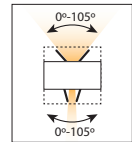
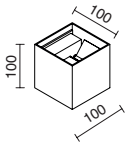

LED COB **2x 3W** 290lm 3000K

- 960A-L3106B-01
- 960A-L3106B-02
- 960A-L3106B-04
- 960A-L3106B-90

P_504





BEAM

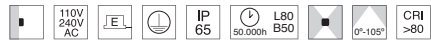

Acabado blanco, negro, antracita o marrón óxido – White, black, anthracite or oxide brown finish

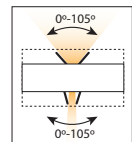
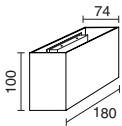

LED COB **2x 6W** **2x 660lm** 3000K

- 960B-L3112B-01
- 960B-L3112B-02
- 960B-L3112B-04
- 960B-L3112B-90

P_502





RHIN



Acabado antracita – Anthracite finish

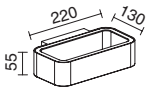

LED COB 7W 448lm 3000K

■ 443A-L0107A-04



FROST



Acabado blanco o antracita – White or anthracite finish

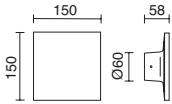

LED SMD 6.5W 800lm 3000K

□ 953A-L3108A-01

■ 953A-L3108A-04

CLOUD



Acabado blanco o antracita – White or anthracite finish

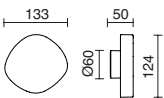

LED SMD AC 75W 800lm 3000K

□ 952A-L3107A-01

■ 952A-L3107A-04



CUB



Acabado blanco o antracita – White or anthracite finish

Lamps P_859

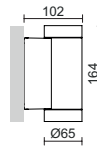
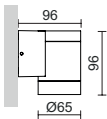

GUI0 LED 4,5W max.



□ 555F-G2IXIA-01

■ 555F-G2IXIA-04

GUI0 LED 2x 4,5W max.



□ 555G-G2IXIA-01

■ 555G-G2IXIA-04





CUB

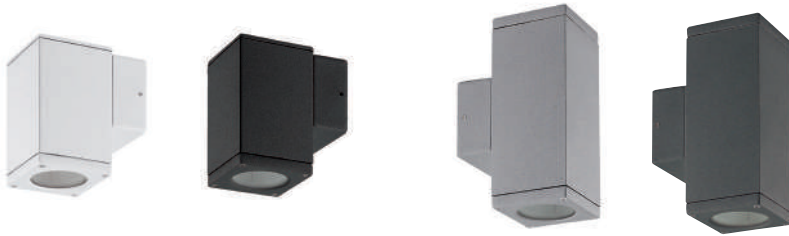

Acabado blanco, negro, gris o antracita – White, black, grey or anthracite finish

Lamps P_859

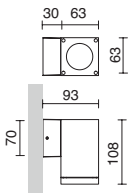

GU10 LED 4,5W max.

- 555C-G2IXIA-01
- 555C-G2IXIA-02
- 555C-G2IXIA-03
- 555C-G2IXIA-04

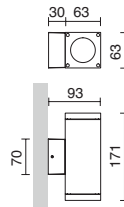

GU10 LED 2x 4,5W max.

- 555D-G2IXIA-01
- 555D-G2IXIA-02
- 555D-G2IXIA-03
- 555D-G2IXIA-04





SUEVIS



Acabado antracita – Anthracite finish

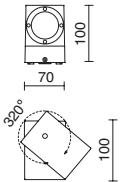

LED COB 7W 750lm 3000K

■ 452B-L0107A-04

P_603



CAIRO



Acabado antracita – Anthracite finish



LED COB 7W 760lm 3000K

■ 537A-L0107A-04

GUIU

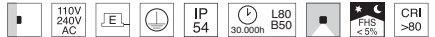

Acabado antracita – Anthracite finish

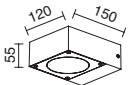

LED SMD 6W 642lm 3000K

■ 447B-L01D6A-04

ARTAL

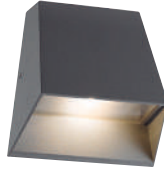

Acabado antracita – Anthracite finish

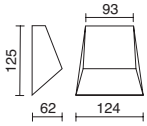

LED COB 7W 780lm 3000K

■ 445A-L0107A-04

CENADI

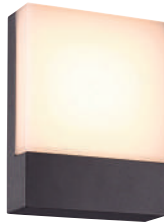

Acabado antracita – Anthracite finish

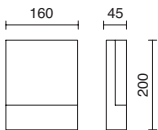

LED SMD 7W 800lm 3000K

■ 536A-L0106A-04

CICLON

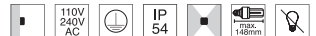

Acabado antracita – Anthracite finish

Lamps P_859

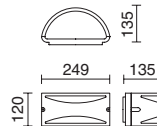
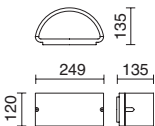

E27 Led/Fluo 20W max.

■ 051A-G05XIA-04

E27 Led/Fluo 20W max.

■ 051B-G05XIA-04

ABAR



Acabado blanco, negro o antracita – White, black or anthracite finish

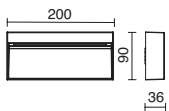

LED SMD 7W 780lm 3000k

□ 847A-L0107B-01

■ 847A-L0107B-02

■ 847A-L0107B-04

PAMPERO



Acabado blanco o gris – White or grey finish

Lamps P_859

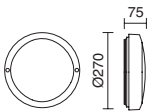

E27 Led/Fluo 11W max.

□ 232A-G05X1A-01

■ 232A-G05X1A-03

FLOC



Acabado blanco o negro – White or black finish

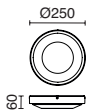

LED SMD AC 20W 2200lm 3000K

□ 1049A-L3120B-01

■ 1049A-L3120B-02

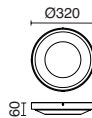

LED SMD AC 30W 3000lm 3000K

□ 1049B-L3130B-01

■ 1049B-L3130B-02



KIRA



Acabado gris o antracita – Grey or anthracite finish

Lamps P_859

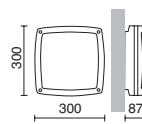
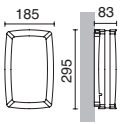

E27 Led/Fluo **2x** 20W max.

■ 169A-G05X1A-03

■ 169A-G05X1A-04

E27 Led/Fluo **2x** 18W max.

■ 169C-G05X1A-04



ABREGO

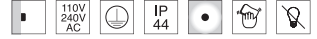

Acabado inox – Stainless steel finish

Lamps P_859

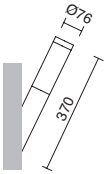

E27 Led/Fluo 11W max.

003A-G05X1A-30



GALERNA

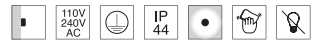

Acabado inox – Stainless steel finish

Lamps P_859

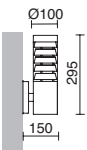

E27 Led/Fluo 18W max.

117C-G05X1A-30



ESTEL

By Fumagalli



Acabado blanco, negro o gris – White, black or grey finish

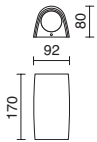

GU10 **2x** 3,5W

□ 793A-G2IXIA-01

■ 793A-G2IXIA-02

■ 793A-G2IXIA-03

K SELECT	2700K	329lm
	4000K	366lm

STORM

By Fumagalli



Acabado blanco, negro o gris – White, black or grey finish

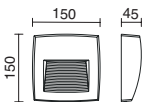

LED R7S Bulb 3,2W

- 947A-L3104A-01
- 947A-L3104A-02
- 947A-L3104A-03

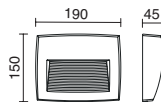

LED R7S Bulb 7,5W

- 947B-L3109A-01
- 947B-L3109A-02
- 947B-L3109A-03

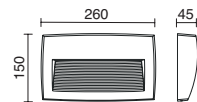

LED R7S Bulb 10,5W

- 947C-L3111A-01
- 947C-L3111A-02
- 947C-L3111A-03

K SELECT	3,2W			7,5W			10,5W		
		2700K	325lm	680lm	1000lm				
	4000K	365lm	775lm	1030lm					
	6500K	365lm	790lm	1060lm					

CALM

By Fumagalli



Acabado blanco, negro o gris – White, black or grey finish

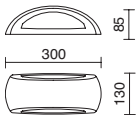

E27 LED 6W 800lm 2700K

□ 646A-G05XIA-01

■ 646A-G05XIA-02

■ 646A-G05XIA-03

□ 646B-G05XIA-01

■ 646B-G05XIA-02

■ 646B-G05XIA-03



Regulación de:
 - Distancia: 0>6 m.
 - Tiempo de activación: de 5 seg. a 8 min.
 - Ángulo de detección: 120°
 - Daylight on: <10 lux

Adjustable:
 - Distance: 0>6 m.
 - Activation time: from 5 sec. to 8 min.
 - Detection angle: 120°
 - Daylight on: <10 lux



BASIC NEW



Acabado blanco – White finish

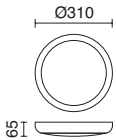

<small>K</small> SELECT	<small>W</small> SELECT	12W	18W	24W
3000K		1230lm	1885lm	2365lm
4000K		1365lm	2150lm	2765lm
6000K		1350lm	2100lm	2675lm

LED SMD

1093A-L4124AB0-01

1093A-L4124NP0-01

1W / 15h

1093A-L4124ZP0-01

Aro decorativo – Decorative ring



A13-1093A-02

MIR

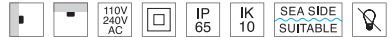

Acabado blanco o negro – White or black finish

Lamps P_859

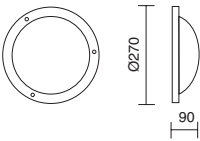

E27 Led/Fluo 23W max.

□ 203B-G05XIA-01

■ 203B-G05XIA-02

PIRO

By Fumagalli



Acabado blanco, negro o gris – White, black or grey finish

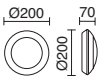

GX53 LED T2 3W

- 559A-G31X1A-01
- 559A-G31X1A-03

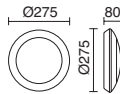

GX53 LED T2 15W/9W

- 559B-G31X1A-01
- 559B-G31X1A-02
- 559B-G31X1A-03

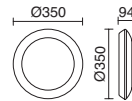

GX53 LED T2 15W/9W

- 559C-G31X1A-01
- 559C-G31X1A-02



K SELECT	3000K	405lm
	4000K	410lm
	6500K	410lm

K SELECT	W SELECT	
		15W 9W
	2700K	1780lm 1200lm
4000K	1940lm 1300lm	

K SELECT	W SELECT	
		15W 9W
	2700K	1780lm 1200lm
4000K	1940lm 1300lm	

TELA

By Fumagalli



Acabado blanco, negro o gris – White, black or grey finish

Lamps P_859

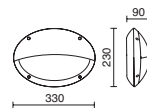
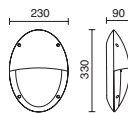
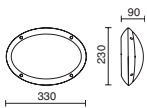

E27 Led/Fluo 23W max.



- 317A-G05XIA-01
- 317A-G05XIA-02
- 317A-G05XIA-03

E27 Led/Fluo 23W max.



- 317B-G05XIA-01
- 317B-G05XIA-02
- 317B-G05XIA-03

E27 Led/Fluo 23W max.



- 317C-G05XIA-01
- 317C-G05XIA-02
- 317C-G05XIA-03

FAR

RANGE
EXTENSION



Acabado blanco o negro – White or black finish

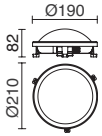

LED SMD 12W 840lm 4000K



- 107J-L0212B-01
- 107J-L0212B-02

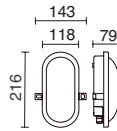

LED SMD 12W 840lm 4000K



- 107J-L0212B-01
- 107J-L0212B-02

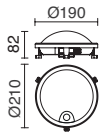

LED SMD 12W 840lm 4000K



- E □ 107K-L0212R-01

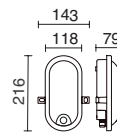

LED SMD 12W 840lm 4000K



- E □ 107L-L0212R-01



Regulación de:

- Distancia: 0,8/10 m.
- Tiempo de activación: de 30 seg. a 5 min.
- Ángulo de detección: 120°
- Daylight on: ≤ 30 lux
- Velocidad de movimiento: 0,6m/s - 1,5m/s

Adjustable:

- Distance: 0,8/10 m.
- Activation time: from 30 sec. to 5 min.
- Detection angle: 120°
- Daylight on: ≤ 30 lux
- Speed of movement: 0,6m/s - 1,5m/s

Con entrada lateral.
With side inlet.





FAR

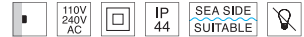

Acabado blanco, negro o gris – White, black or grey finish

Lamps P_859

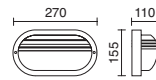
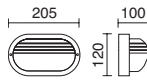

E27 Led/Fluo 12W max.



□ 107B-G05X1A-01

■ 107B-G05X1A-02

E27 Led/Fluo 12W max.



□ 107G-G05X1A-01

■ 107G-G05X1A-02

E27 Led/Fluo 21W max.



□ 107H-G05X1A-01

■ 107H-G05X1A-02

KAPPA



Acabado blanco o negro – White or black finish

Disponible versión con portalámparas E27
E27 socket version available

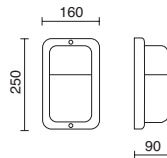
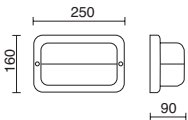

LED SMD AC 9W 1160lm **3000K**

- 166A-L0109B-01
- 166A-L0109B-02

LED SMD AC 9W 1240lm **4000K**

- 166A-L0209B-01
- 166A-L0209B-02

LED SMD AC 9W 1160lm **3000K**

- 166B-L0109B-01
- 166B-L0109B-02

LED SMD AC 9W 1240lm **4000K**

- 166B-L0209B-01
- 166B-L0209B-02

DEVON

By Fumagalli



Acabado blanco, negro o gris – White, black or grey finish

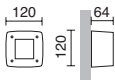

GX53 LED T2 3W

■ 084K-G3IX1A-02

■ 084K-G3IX1A-03

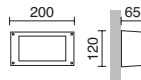

GX53 LED T2 3W

■ 084Q-G3IX1A-02

■ 084Q-G3IX1A-03

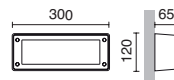
**2x** GX53 LED T2 3W

□ 084U-G3IX2A-01

■ 084U-G3IX2A-02

■ 084U-G3IX2A-03

K SELECT	3000K	405lm
	4000K	410lm
	6500K	410lm

K SELECT	3000K	405lm
	4000K	410lm
	6500K	410lm

K SELECT	3000K	810lm
	4000K	820lm
	6500K	820lm

DEVON

By Fumagalli



Acabado blanco, negro o gris – White, black or grey finish

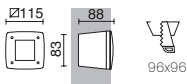

GX53 LED T2 3W

- 084A-G3IXIA-01
- 084A-G3IXIA-02
- 084A-G3IXIA-03

K SELECT	3000K	405lm
	4000K	410lm
	6500K	410lm

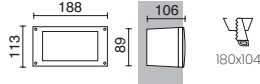

GX53 LED T2 3W

- 084G-G3IXIA-01
- 084G-G3IXIA-02
- 084G-G3IXIA-03

K SELECT	3000K	405lm
	4000K	410lm
	6500K	410lm

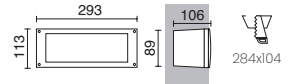

2x GX53 LED T2 3W

- 084A-G3IX2A-01
- 084A-G3IX2A-02
- 084A-G3IX2A-03

K SELECT	3000K	810lm
	4000K	820lm
	6500K	820lm

DEVON

By Fumagalli



Acabado blanco, negro o gris – White, black or grey finish

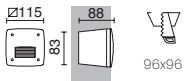

96x96

GX53 LED T2 3W

- 084C-G31X1A-01
- 084C-G31X1A-03

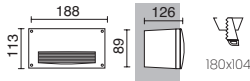

180x104

GX53 LED T2 3W

- 084I-G31X1A-01
- 084I-G31X1A-02
- 084I-G31X1A-03

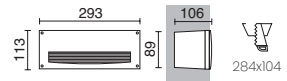

284x104

2x GX53 LED T2 3W

- 084C-G31X2A-01
- 084C-G31X2A-02
- 084C-G31X2A-03

K SELECT	3000K	405lm
	4000K	410lm
	6500K	410lm

K SELECT	3000K	405lm
	4000K	410lm
	6500K	410lm

K SELECT	3000K	810lm
	4000K	820lm
	6500K	820lm

DEVON

By Fumagalli

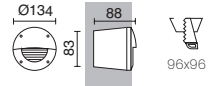
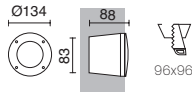
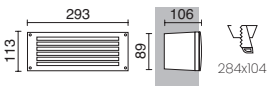

Acabado negro o gris – Black or grey finish

**2x** GX53 LED T2 3W

- 084B-G31X2A-02
- 084B-G31X2A-03

K SELECT	3000K	810lm
	4000K	820lm
	6500K	820lm

GX53 LED T2 3W

- 084D-G31X1A-02
- 084D-G31X1A-03

K SELECT	3000K	405lm
	4000K	410lm
	6500K	410lm

GX53 LED T2 3W

- 084F-G31X1A-02
- 084F-G31X1A-03

K SELECT	3000K	405lm
	4000K	410lm
	6500K	410lm

DAMBEL

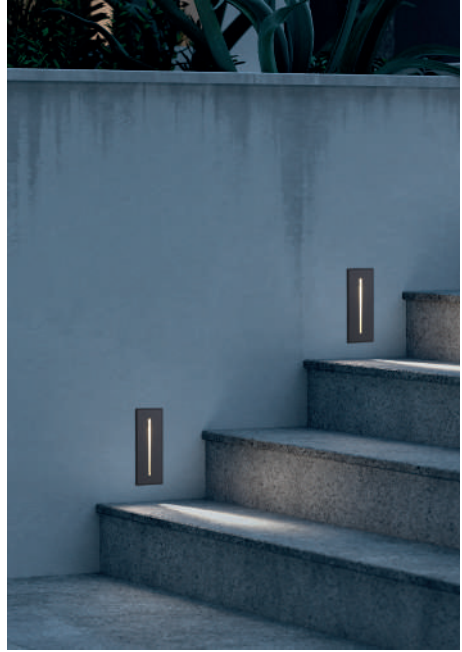

Acabado gris o antracita – Grey or anthracite finish

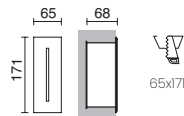
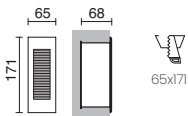

LED SMD 3W 170lm 3000K



■ 543A-L0103A-03

■ 543A-L0103A-04

LED SMD 3W 170lm 3000K



■ 543B-L0103A-03

■ 543B-L0103A-04

LARA



Acabado blanco o antracita – White or anthracite finish

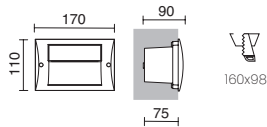
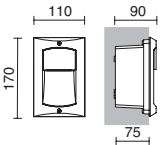

LED SMD 4W 480lm 3000K

□ 854A-L0104A-01

■ 854A-L0104A-04

LED SMD 4W 480lm 3000K

□ 854B-L0104A-01

■ 854B-L0104A-04

AMBERES

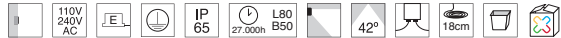

Acabado antracita – Anthracite finish

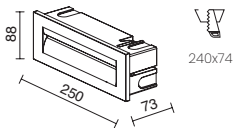

LED SMD 9W 760lm 3000K

■ 643A-L0109A-04

XALOC



Acabado blanco, negro o inox – White, black or stainless steel finish

Lamps P_859

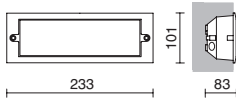

243x102



E27 Led/Fluo 20W max.



□ 350A-G05XIA-01

■ 350A-G05XIA-02

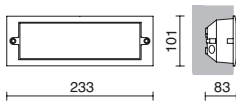

243x102



E27 Led/Fluo 20W max.

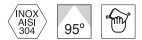

■ 350C-G05XIA-30

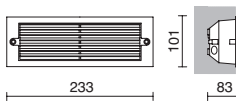

243x102



E27 Led/Fluo 20W max.



■ 350D-G05XIA-30

WIND

By Fumagalli



Acabado blanco, negro o gris – White, black or grey finish

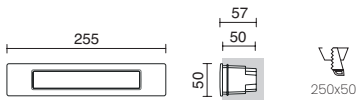

R7s LED Bulb 10,5W max. 1100lm

- 949A-L3111A-01
- 949A-L3111A-02
- 949A-L3111A-03

K SELECT	2700K	1000lm
	4000K	1130lm
	6500K	1060lm

DONISI



Acabado inox – Stainless steel finish

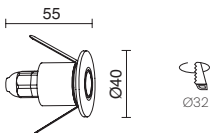

LED SMD 1W 105lm 3000K

■ 546A-L0101A-30

NO BOX INCLUDED
Ø32mm PVC TUBE

Posibilidad de añadir filtros de colores (no incluidos).
Possibility to add colour filters (not included).

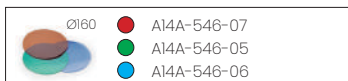

MIST

By Fumagalli



Acabado blanco, negro o gris – White, black or grey finish

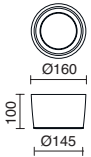

GX53 LED T2 10W

□ 948A-L3110A-01

■ 948A-L3110A-02

■ 948A-L3110A-03

K SELECT	3000K	1190lm
	4000K	1290lm
	6500K	1210lm

CUB



Acabado blanco, negro, gris o antracita – White, black, grey or anthracite finish

Lamps P_859

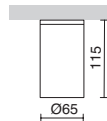
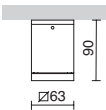

GU10 LED 4,5W max.



- 555E-G2IXIA-01
- 555E-G2IXIA-02
- 555E-G2IXIA-03
- 555E-G2IXIA-04

GU10 LED 4,5W max.

- 555H-G2IXIA-01
- 555H-G2IXIA-04



¿Cómo instalar un empotrable en el suelo?



How to install a recessed floor?



Uplights_

SHINNY



Acabado antracita – Anthracite finish

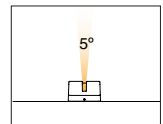
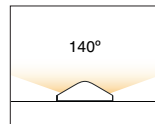
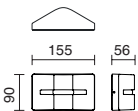

LED SMD 2,5W 170lm 3000K

■ 951A-L3103A-04



BERNA



Acabado inox – Stainless steel finish

 Connectors P_861

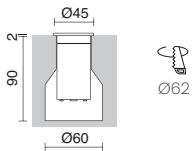

LED SMD 1W 105lm 3000K

 912A-L0101F-30



Alimentador – Power supply
12W (max. 9 unit.)

IN OUT

B02Q-X3312F-01

90V
255V
AC

24V
DC

IP
30



Evite siempre colocar las luminarias en vaguadas o depresiones del terreno. Es indispensable realizar un drenaje.
Always avoid placing the lights in valleys or depressions of the ground. It is essential to carry out an efficient drainage.

SIO

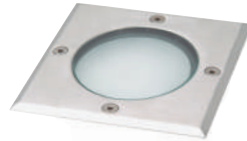

Acabado inox – Stainless steel finish

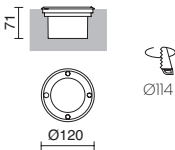

GX53 LED T2 3W 350lm 4000K

■ 379A-G3IXIA-30

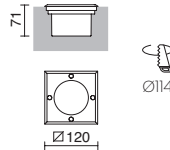

GX53 LED T2 3W 350lm 4000K

■ 379B-G3IXIA-30



Evite siempre colocar las luminarias en vaguadas o depresiones del terreno. Es indispensable realizar un drenaje.
Always avoid placing the lights in valleys or depressions of the ground. It is essential to carry out an efficient drainage.

CLOT

RANGE
EXTENSION



Acabado inox – Stainless steel finish



Connectors P_861

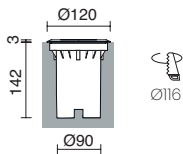

LED SMD 5W 850lm 3000K

■ 1083A-L3106A-30

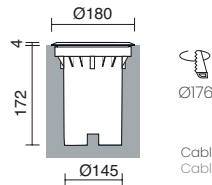

Ø176
Cable con dispositivo H2O STOP
Cable with H2O STOP system

LED SMD 16W 2250lm 3000K

■ 1083B-L3116A-30



Evite siempre colocar las luminarias en vaguadas o depresiones del terreno. Es indispensable realizar un drenaje.
Always avoid placing the lights in valleys or depressions of the ground. It is essential to carry out an efficient drainage.



BORA



Acabado inox – Stainless steel finish

Lamps P_859

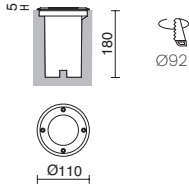

Doble posición del portalámparas.
Double positioning of the lamp holder.

GU10 LED 4,5W max.

■ 037A-G2IXIA-30

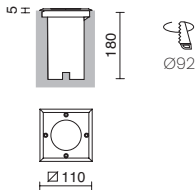

Doble posición del portalámparas.
Double positioning of the lamp holder.

GU10 LED 4,5W max.

■ 037B-G2IXIA-30

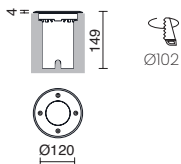

GU10 LED 3,5W max.

■ 037D-G2IXIA-30



Evite siempre colocar las luminarias en vaguadas o depresiones del terreno. Es indispensable realizar un drenaje.
Always avoid placing the lights in valleys or depressions of the ground. It is essential to carry out an efficient drainage.

WALKER



Acabado inox – Stainless steel finish

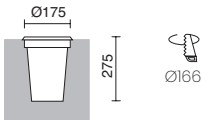

LED COB 6,5W 850lm 3000K

■ 349A-L0107B-30



Incorpora un cristal matizado interno.
Incorporates internal frosted glass lens.



Acabado inox – Stainless steel finish

Lamps P_859

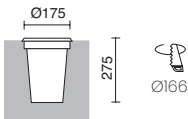

E27 Led/Fluo 23W max.

■ 349A-G05X1A-30



Evite siempre colocar las luminarias en vaguadas o depresiones del terreno. Es indispensable realizar un drenaje.
Always avoid placing the lights in valleys or depressions of the ground. It is essential to carry out an efficient drainage.

RAIN



Acabado blanco, negro o gris – White, black or grey finish

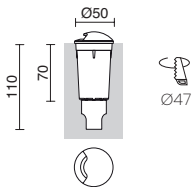

G9 LED Bulb 1,7W max. 150lm 3000K

- 950B-L3102A-01
- 950B-L3102A-02
- 950B-L3102A-03

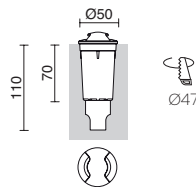

G9 LED Bulb 1,7W max. 150lm 3000K

- 950C-L3102A-01
- 950C-L3102A-02
- 950C-L3102A-03



Evite siempre colocar las luminarias en vaguadas o depresiones del terreno. Es indispensable realizar un drenaje.
Always avoid placing the lights in valleys or depressions of the ground. It is essential to carry out an efficient drainage.

RAIN

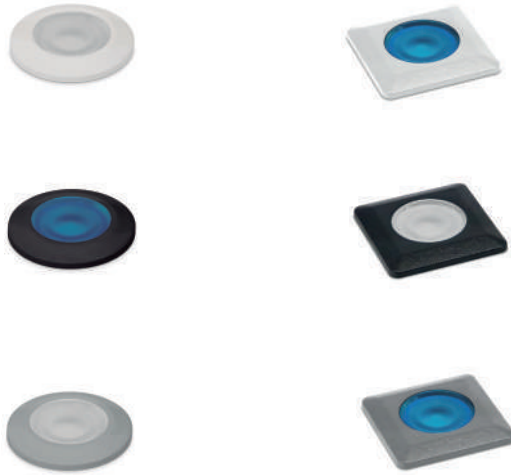

Acabado blanco, negro o gris – White, black or grey finish

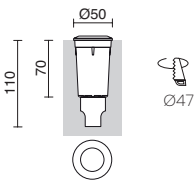

G9 LED Bulb 1,7W max. 150lm 3000K

- 950A-L1002A-01
- 950A-L1002A-02
- 950A-L1002A-03
- 950A-L3102A-01
- 950A-L3102A-02
- 950A-L3102A-03

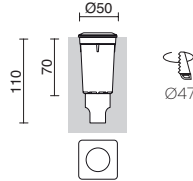

G9 LED Bulb 1,7W max. 150lm 3000K

- 950D-L1002A-01
- 950D-L1002A-02
- 950D-L1002A-03
- 950D-L3102A-01
- 950D-L3102A-02
- 950D-L3102A-03



Evite siempre colocar las luminarias en vaguadas o depresiones del terreno. Es indispensable realizar un drenaje.
Always avoid placing the lights in valleys or depressions of the ground. It is essential to carry out an efficient drainage.

BELGRADO

By Fumagalli



Acabado negro – Black finish

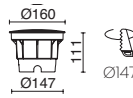
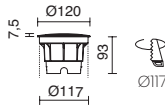
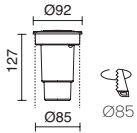

GU10 LED 3,5W

GX53 LED T2 3W

GX53 LED T2 10W

■ 557A-G2IXIA-02

■ 373A-G3IXIA-02

■ 372A-G3IXIA-02

■ 557B-G2IXIA-02

■ 373B-G3IXIA-02

■ 372B-G3IXIA-02

■ 557C-G2IXIA-02

■ 373C-G3IXIA-02

■ 372C-G3IXIA-02

K SELECT	2700K	329lm
	4000K	366lm

K SELECT	3000K	405lm
	4000K	410lm
	6500K	410lm

K SELECT	3000K	1190lm
	4000K	1290lm
	6500K	1210lm

Posibilidad de añadir filtros de colores (no incluidos).
Possibility to add colour filters (not included).

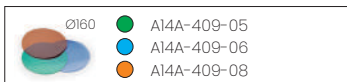

Evite siempre colocar las luminarias en vaguadas o depresiones del terreno. Es indispensable realizar un drenaje.
Always avoid placing the lights in valleys or depressions of the ground. It is essential to carry out an efficient drainage.

MARTINA



Acabado antracita – Anthracite finish

 Connectors P_861

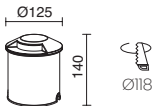

LED SMD 7W 700lm **3000K**

■ 645A-L0107A-04



LED SMD 7W 700lm **3000K**

■ 645B-L0107A-04



LED SMD 7W 744lm **4000K**

■ 645A-L0207A-04



LED SMD 7W 744lm **4000K**

■ 645B-L0207A-04



Evite siempre colocar las luminarias en vaguadas o depresiones del terreno. Es indispensable realizar un drenaje.
Always avoid placing the lights in valleys or depressions of the ground. It is essential to carry out an efficient drainage.

Spotlights_

KERO



Acabado negro – Black finish



LED SMD AC 30W 3335lm **3000K**

■ 1047A-L3130B-02



LED SMD AC 50W 5190lm **3000K**

■ 1047B-L3150B-02

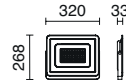

LED SMD AC 100W 10478lm **3000K**

■ 1047C-L31A1B-02

LED SMD AC 30W 3425lm **4000K**

■ 1047A-L3330B-02

LED SMD AC 50W 5535lm **4000K**

■ 1047B-L3350B-02

LED SMD AC 100W 11113lm **4000K**

■ 1047C-L33A1B-02

LED SMD AC 30W 3425lm **6500K**

■ 1047A-L3730B-02

LED SMD AC 50W 5535lm **6500K**

■ 1047B-L3750B-02

LED SMD AC 100W 11113lm **6500K**

■ 1047C-L37A1B-02

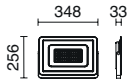

LED SMD AC 150W 15640lm **3000K**

■ 1047D-L31A4B-02

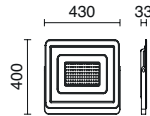

LED SMD AC 200W 19555lm **3000K**

■ 1047E-L31A5B-02

LED SMD AC 150W 16175lm **4000K**

■ 1047D-L33A4B-02

LED SMD AC 200W 20805lm **4000K**

■ 1047E-L33A5B-02

LED SMD AC 150W 16175lm **6500K**

■ 1047D-L37A4B-02



ABADIA



Acabado antracita – Anthracite finish

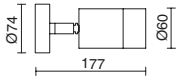

GU10 LED 4,5W max.

■ 538A-G2IXIA-04

NAGORE



Acabado antracita – Anthracite finish

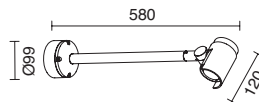

LED COB 7W 830lm 3000K

■ 851A-L3107A-04

LED COB 7W 830lm 3000K

■ 851B-L3107A-04

Boutique



PREMIUM QUALITY



LULU

By Fumagalli



Acabado negro – Black finish

Lamps P_860

Connectors P_861

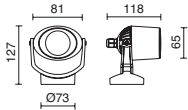

GU10 LED 3,5W

■ 572A-G2IXIA-02



2700K	329lm
4000K	366lm

Piqueta – Spike

RESIN



■ A05A-409-02

GERONIMO RANGE EXTENSION



PA GLASS
TRANS



110V
240V
AC



IP
67

IK
07

355°



IP44

2m

SEA SIDE
SUITABLE



Acabado negro – Black finish

Lamps P_860

Connectors P_861

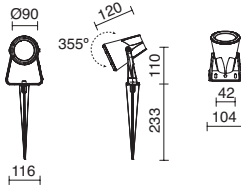

GUI0 LED 4,5W max.

■ 463A-G2IXIA-02

■ 463A-G2IXIA-90

BRANCA

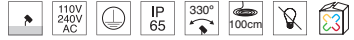

Acabado negro – Black finish

Lamps P_860
Connectors P_861



GU10 LED 4,5W max.

■ 1085A-G2IXIA-02

GU10 LED 4,5W max.

■ 1085B-G2IXIA-02

2x GU10 LED 4,5W max.

■ 1085C-G2IXIA-02





BARNI



Acabado antracita – Anthracite finish



Connectors P_86I

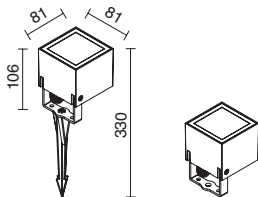

LED SMD 8W 430lm 3000K

■ 551B-L0108A-04



TEVA

RGB+W (3000K)



Acabado negro – Black finish

 Connectors P_86I

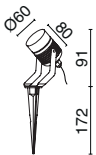

LED 3W (RGB) + 6W (WHITE) 380lm 3000K

tuya[®]

■ 1081A-L1406E2T-02



Alimentador – Power supply

max. 30W

max. 75W

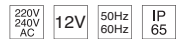

B02E-X3330E-00

B02E-X3375E-00



TERRA



Acabado antracita, verde y marrón – Anthracite green, and brown finish



Connectors P_861

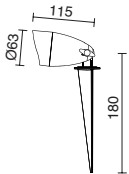

1700K

LED SMD AC 6W max. 640lm

3000K

LED SMD AC 6W max. 640lm

4000K

LED SMD AC 6W max. 660lm

■ 996A-L3106B-04

■ 996A-L3106B-05

■ 996A-L3106B-90

■ 996A-L3306B-04

220V
240V
AC

E ■ 996A-L2806C-04

■ 996A-L3106C-04

110V
130V

1700K

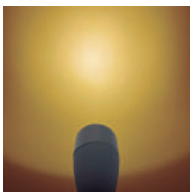

3000K

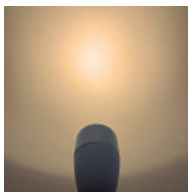

4000K

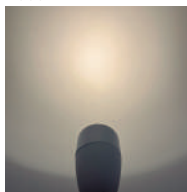



CATANIA

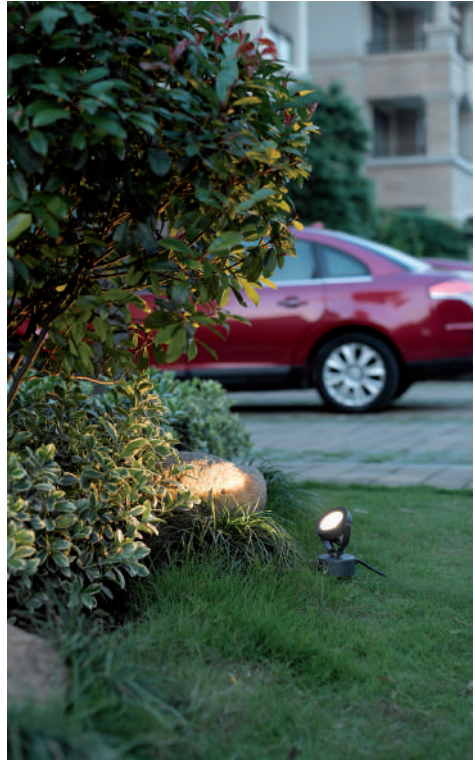

Acabado antracita – Anthracite finish

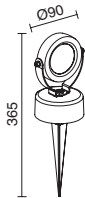

LED COB 7W 777lm 3000K

■ 482A-L0107A-04

ARAMO



Acabado antracita – Anthracite finish

Lamps P_860
Connectors P_861

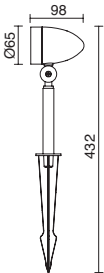

GU10 LED 4,5W max.

■ 539A-G2IXIA-04

KOBE



INOX
AISI 304

GLASS
TRANS



110V
240V
AC



IP
44



Acabado inox – Stainless steel finish

Lamps P_860

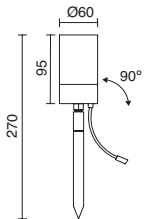

GU10 LED 4,5W max.

■ 172A-G2IXIA-30

SEDNA

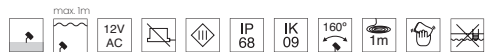

Acabado inox — Stainless steel finish

Connectors P_861

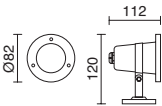

LED SMD 3W 250lm 4000K

■ 642A-L0203D-30

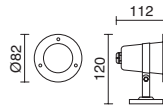

GU5,3 LED HAL 3,5W max.

■ 642A-G23XID-30



	Alimentador / Power supply		
	IN 220-240 V AC / OUT 12 V AC max. 50W		
	B02J-X3350D-02		

RIGA

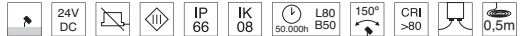
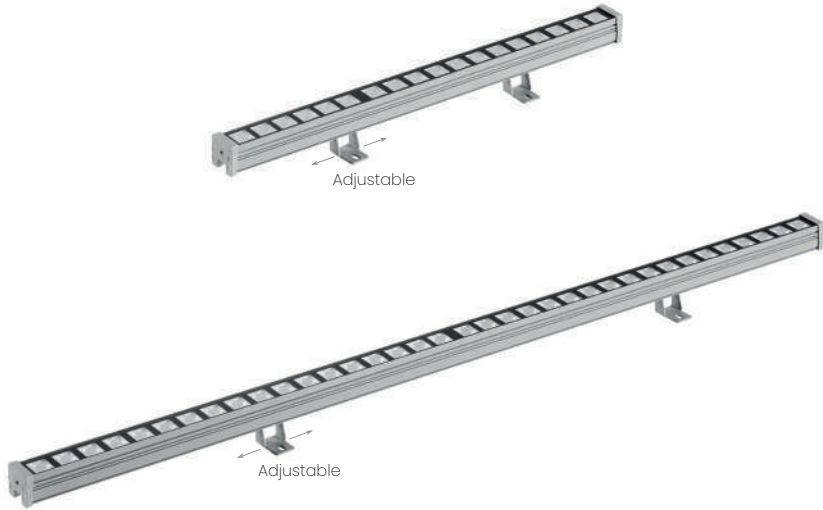

Acabado gris – Grey finish

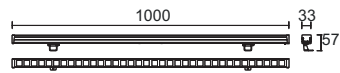

Connectors P_861

LED SMD 18Wmax. 2430lm **3000K**

1025A-L3118F40-03

1025A-L3118FK0-03

LED SMD 36W 4860lm **3000K**

1025B-L3136F40-03

1025B-L3136FK0-03

LED SMD 18Wmax. 2610lm **4000K**

1025A-L3318F40-03

1025A-L3318FK0-03

LED SMD 36W 5220lm **4000K**

1025B-L3336F40-03

1025B-L3336FK0-03



Regulable con dispositivos de control específicos y Led Driver 24V DC remotos (P_859)
Adjustable with specific control devices and remote Led Driver 24V DC (P_859)



Alimentador – Power supply

35W

B02R-X3335F-00

60W

B02R-X3360F-00





RIGA

RGB+W (4000K)



Acabado gris – Grey finish

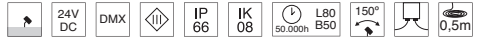

Led Driver 24V DC remotos a consultar P_862
Remote Led Driver 24V DC under request P_862

Connectors P_861

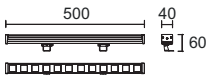

LED SMD RGBW (4000K) 18W max. 1200lm

■ 1025C-L1418F4X-03

■ 1025C-L1418FKX-03

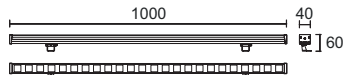

LED SMD RGBW (4000K) 36W max. 2400lm

■ 1025D-L1436F4X-03

■ 1025D-L1436FKX-03



Kit Controlador y mando a distancia para RGB/RGBW
Controller and remote control kit for RGB/RGBW

CONT.R9+XC

Controller
Control: RF 2.4Ghz
Exit sign: DMX512
Input Voltage: 5-24Vdc
10 statics colors
32 dynamics modes

Remote Control
Control: 1 zone (30m)
Power supply: ixCR2032
Non include (3Vdc)
Exit sign: RF 2.4Ghz

Resistencia de terminación DMX (120ohm)
DMX terminating resistor (120ohm)

■ RES-1089A-38





¿Cómo instalar una baliza?



How to install a bollard?



Bollards_

FLAT



Acabado antracita – Anthracite finish

Conector IP67 incluido
IP67 connector included

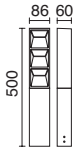

LED SMD 10W 1550lm 3000K

■ 1086B-L3109A90-04

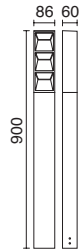

LED SMD 10W 1550lm 3000K

■ 1086C-L3109A90-04



Instalar sobre suelo rígido. En césped o tierra, añadir pilastera de cemento.
Install on rigid ground. On grass or earth, add pilaster cement.

P_482





ORBITA



Acabado antracita – Anthracite finish



Conector incluido
Connector included

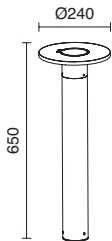

LED SMD 8W 1300lm 3000K

■ 1054B-L3110B-04

P_484



Instalar sobre suelo rígido. En césped o tierra, añadir pilastra de cemento.
Install on rigid ground. On grass or earth, add pilaster cement.





IKONA



Acabado negro – Black finish

 Connectors P_861

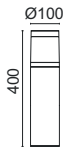

LED SMD 7W

■ 1072B-L4108BBF-02

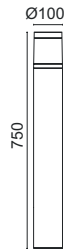

LED SMD 7W

■ 1072C-L4108BBF-02

K SELECT	3000K	790lm
	4000K	845lm



Instalar sobre suelo rígido. En césped o tierra, añadir pilastro de cemento.
Install on rigid ground. On grass or earth, add pilaster cement.

P_490





SIMIL

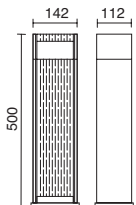

Acabado antracita – Anthracite finish

Imitación madera
Imitation woodConector IP67 incluido
IP67 connector included

LED SMD 7W 810lm 3000K

■ 1027B-L3107B30-04

P_492

Instalar sobre suelo rígido. En césped o tierra, añadir pilastra de cemento.
Install on rigid ground. On grass or earth, add pilaster cement.



LUG



Acabado blanco o antracita – White or anthracite finish

Lamps P_859

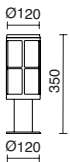

E27 Led/Fluo 18W max.

- 1015B-G05X1A-01
- 1015B-G05X1A-04

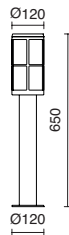

E27 Led/Fluo 18W max.

- 1015C-G05X1A-01
- 1015C-G05X1A-04



Instalar sobre suelo rígido. En césped o tierra, añadir pilastra de cemento.
Install on rigid ground. On grass or earth, add pilaster cement.

P_494





LOOP



Acabado negro – Black finish

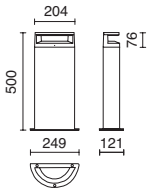

LED SMD 9,5W 1295lm **3000K**

■ 982B-L3109A-02

LED SMD 9,5W 1405lm **4000K**

■ 982B-L3309A-02

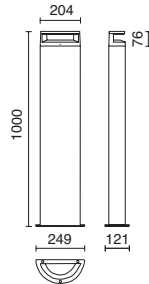

LED SMD 9,5W 1295lm **3000K**

■ 982C-L3109A-02

LED SMD 9,5W 1405lm **4000K**

■ 982C-L3309A-02



Instalar sobre suelo rígido. En césped o tierra, añadir pilastro de cemento.
Install on rigid ground. On grass or earth, add pilaster cement.

P_495





AVON



Acabado antracita — Anthracite finish

Lamps P_859

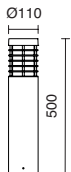

E27 Led/Fluo 15W max.

■ 1016B-G05XIA-04



Instalar sobre suelo rígido. En césped o tierra, añadir pilastra de cemento.
Install on rigid ground. On grass or earth, add pilaster cement.

P_496





GUIU



Acabado antracita — Anthracite finish

Lamps P_860

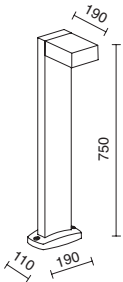

GX53 LED T2 3W 350lm 4000K

■ 447A-G3IXIA-04



Instalar sobre suelo rígido. En césped o tierra, añadir pilastra de cemento.
Install on rigid ground. On grass or earth, add pilaster cement.

P_515



SUEVIS



Acabado antracita – Anthracite finish

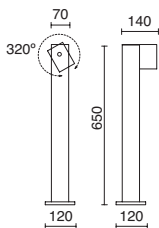

LED COB 7W 750lm 3000K

■ 452A-L0107A-04



Instalar sobre suelo rígido. En césped o tierra, añadir pilastra de cemento.
Install on rigid ground. On grass or earth, add pilaster cement.

P_514



CAIRO



Acabado antracita — Anthracite finish

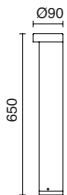

LED COB 7W 760lm 3000K

■ 537B-L0107A-04



Instalar sobre suelo rígido. En césped o tierra, añadir pilastra de cemento.
Install on rigid ground. On grass or earth, add pilaster cement.

P_515



CASTELLO

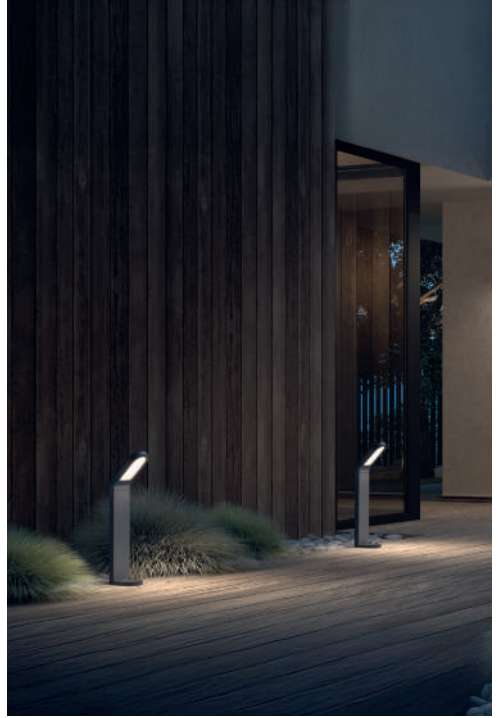

Acabado antracita – Anthracite finish

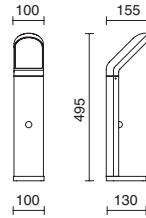
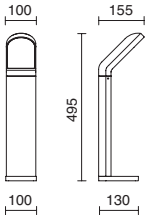

LED SMD 10W 1200lm 3000K



■ 534B-L0109A-04

LED SMD 10W 1200lm 3000K



■ 534D-L0109B-04



Regulación de:
- Distancia: 0-8 m.
- Tiempo de activación: de 6 seg. a 8 min.
- Ángulo de detección: 160°

Adjustable:
- Distance: 0-8 m.
- Activation time: from 6 sec. to 8 min.
- Detection angle: 160°



Instalar sobre suelo rígido. En césped o tierra, añadir pilastra de cemento.
Install on rigid ground. On grass or earth, add pilaster cement.

P_498



ADAY



Acabado antracita – Anthracite finish

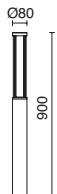

LED SMD 19W 2500lm 3000K

■ 848B-L0118A-04

LED SMD 19W 2500lm 3000K

■ 848C-L0118A-04



Instalar sobre suelo rígido. En césped o tierra, añadir pilastra de cemento.
Install on rigid ground. On grass or earth, add pilaster cement.

P_496





ARLEN



Acabado antracita – Anthracite finish

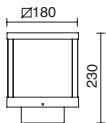

LED COB 12W 1300lm 3000K

■ 791B-L0112A-04

P_500



Instalar sobre suelo rígido. En césped o tierra, añadir pilastra de cemento.
Install on rigid ground. On grass or earth, add pilaster cement.





SIBILA



Acabado antracita – Anthracite finish

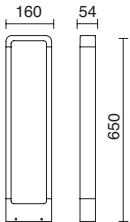

LED COB 7W 750lm 3000K

■ 455A-L0105A-04



Instalar sobre suelo rígido. En césped o tierra, añadir pilastra de cemento.
Install on rigid ground. On grass or earth, add pilaster cement.

SIBILA



Acabado blanco o antracita – White or anthracite finish

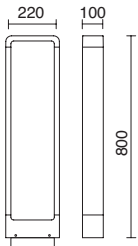

LED COB AC 10W 1050lm 3000K

□ 455B-L0110B-01

■ 455B-L0110B-04



Instalar sobre suelo rígido. En césped o tierra, añadir pilastra de cemento.
Install on rigid ground. On grass or earth, add pilaster cement.

ADRANO



Acabado antracita – Anthracite finish

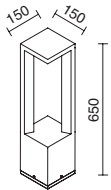

LED COB 8W 800lm 3000K

■ 552A-L0108A-04



Instalar sobre suelo rígido. En césped o tierra, añadir pilastra de cemento.
Install on rigid ground. On grass or earth, add pilaster cement.

ODIN



Acabado antracita – Anthracite finish

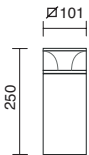

LED SMD 7W 850lm 3000K

■ 941A-L0106A-04

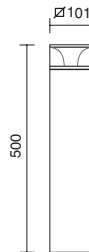

LED SMD 7W 850lm 3000K

■ 941B-L0106A-04



Instalar sobre suelo rígido. En césped o tierra, añadir pilastra de cemento.
Install on rigid ground. On grass or earth, add pilaster cement.

LUA

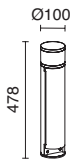

Acabado antracita — Anthracite finish

2 Schuko (type C/F)
16A/ 250V max 3680W

G9 2,5W 160lm 3000K

■ 995A-H20XIA-04



Instalar sobre suelo rígido. En césped o tierra, añadir pilastra de cemento.
Install on rigid ground. On grass or earth, add pilaster cement.



JASMIN



Acabado gris o antracita – Grey or anthracite finish

Lamps P_859

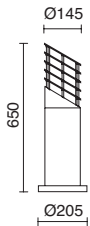

E27 Led/Fluo 23W max.

■ 159A-G05X1A-03

■ 159A-G05X1A-04



Instalar sobre suelo rígido. En césped o tierra, añadir pilastra de cemento.
Install on rigid ground. On grass or earth, add pilaster cement.

NATAN



Acabado antracita – Anthracite finish

Lamps P_859

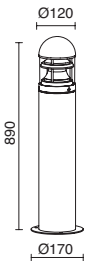

E27 Fluo 20W max. (Ø48mm)

■ 448A-G05X1A-04



Instalar sobre suelo rígido. En césped o tierra, añadir pilastra de cemento.
Install on rigid ground. On grass or earth, add pilaster cement.

OMO



Acabado blanco, negro, antracita, verde o marrón cobrizo
White, black, anthracite, green or copper brown

Lamps P_859

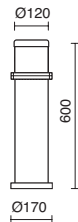
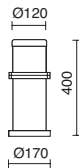
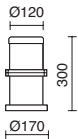

E27 Led/Fluo 23W max.

- 228A-G05XIA-01
- 228A-G05XIA-02
- 228A-G05XIA-04
- 228A-G05XIA-05
- 228A-G05XIA-91

E27 Led/Fluo 23W max.

- 228B-G05XIA-01
- 228B-G05XIA-02
- 228B-G05XIA-04
- 228B-G05XIA-05
- 228B-G05XIA-91

E27 Led/Fluo 23W max.

- 228C-G05XIA-01
- 228C-G05XIA-02
- 228C-G05XIA-04
- 228C-G05XIA-05
- 228C-G05XIA-91

E27 Led/Fluo 23W max.

- 228D-G05XIA-01
- 228D-G05XIA-02
- 228D-G05XIA-04
- 228D-G05XIA-05
- 228D-G05XIA-91



Instalar sobre suelo rígido. En césped o tierra, añadir pilastra de cemento.
Install on rigid ground. On grass or earth, add pilaster cement.



SIROCO



Acabado gris o antracita – Grey or anthracite finish

Lamps P_859

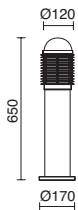

E27 Led/Fluo 14W max.

■ 286A-G05XIA-03

■ 286A-G05XIA-04



Instalar sobre suelo rígido. En césped o tierra, añadir pilastra de cemento.
Install on rigid ground. On grass or earth, add pilaster cement.

SAURO

By Fumagalli



E27

GX53



Acabado negro – Black finish

Lamps P_859

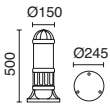

E27 Led/Fluo 30W max.

■ 272A-G05XIA-02

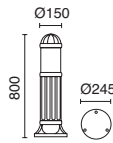

E27 Led/Fluo 30W max.

■ 272B-G05XIA-02

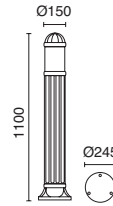

E27 Led/Fluo 30W max.

■ 272C-G05XIA-02



GX53 LED T2 10W

■ 272A-G3IXIA-02

GX53 LED T2 10W

■ 272B-G3IXIA-02

GX53 LED T2 10W

■ 272C-G3IXIA-02



K SELECT	3000K	1190lm
	4000K	1290lm
	6500K	1210lm

 Instalar sobre suelo rígido. En césped o tierra, añadir pilastra de cemento.
Install on rigid ground. On grass or earth, add pilaster cement.

ABREGO



Acabado inox – Stainless steel finish

Lamps P_859



E27 Led/Fluo 11W max.

■ 003B-G05XIA-30



Instalar sobre suelo rígido. En césped o tierra, añadir pilastra de cemento.
Install on rigid ground. On grass or earth, add pilaster cement.

P_523



GALERNA



Acabado inox – Stainless steel finish

Lamps P_859

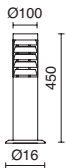

E27 Led/Fluo 18W max.

■ 117B-G05X1A-30



Instalar sobre suelo rígido. En césped o tierra, añadir pilastra de cemento.
Install on rigid ground. On grass or earth, add pilaster cement.

P_523



Solar Lights_

ERGO



Acabado negro – Black finish

Tiempo de carga: 6/8h. Duración carga completa: Hasta 12h
Loading time: 6/8h. Full load duration: Up to 12h



LED SMD 4,5W

■ 1044A-L4105K-02

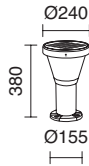

LED SMD 4,5W

■ 1044B-L4105K-02

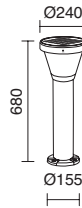

■ 1044C-L4105K-02



☀ ☾	🔌	💡
< 25 lux	1st H.	100%
	2nd H.	80%
	3rd-4th H.	60%
	5th-7th H.	40%
	8th-12th H.	30%



MODE A 3000K 435lm
MODE B 4000K 445lm
MODE C OFF -



Instalar sobre suelo rígido. En césped o tierra, añadir pilastro de cemento.
Install on rigid ground. On grass or earth, add pilaster cement.



100% Seguro – Safety
>2000 Ciclos – Cycles
Carga rápida – Fast charge



VERSA



ABS + ALU 





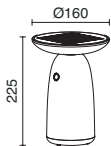

Acabado negro – Black finish

Tiempo de carga: 8h (solar) / 4h (USB)
Loading time: 8h (sunshine) / 4h (USB)



LED SMD 10W 1000lm 3000K

■ 1041A-L4103K-02

			
< 25 lux	MODE A	100lm	10h
	MODE B	500lm	5h
	MODE C	1000lm	1,5h
	MODE D	OFF	-



LUMBER



ABS PC OPAL

Acabado negro – Black finish

Tiempo de carga: 5/6h
Loading time: 5/6h

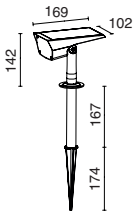

LED SMD 2W 160lm 3000K

■ 1043A-L4103K-02

< 25 lux	MODE A	100%	12h
	MODE B	60%	20h
	MODE C	OFF	-





TONA



Acabado negro — Black finish

Tiempo de carga: 8h
Loading time: 8h

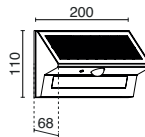
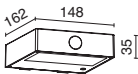

LED SMD 6W 600lm 3000K

■ 1042A-L4106K-02

LED SMD 6W 600lm 3000K

■ 1042B-L4106K-02

< 25 lux	MODE A	75lm	75lm	16h	
	MODE B	75lm	400lm x25seg.	10h	
	MODE C	OFF	600lm x25seg.	3h(ONx430)	

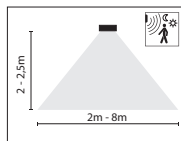



COMO

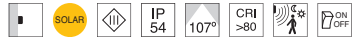

Acabado antracita – Anthracite finish

Tiempo de carga: 6/8h
Loading time: 6/8h

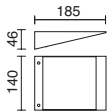

LED SMD 2,2W 480lm 3000K

■ 916B-L0103K-04

< 20 lux	ON	100%		2,5 h
-	OFF	0%	X	20 h
-	OFF	0%	-	-



COMO



Acabado antracita – Anthracite finish

Tiempo de carga: 6/8h
Loading time: 6/8h

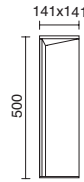
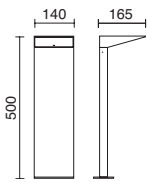

LED SMD 2,2W 480lm 3000K



LED SMD 2,2W 525lm 3000K



■ 916A-L0103K-04

■ 916C-L0103K-04

< 20 lux	ON	100%		2,5 h
-	OFF	15%	X	20 h
-	-	0%	-	-



Instalar sobre suelo rígido. En césped o tierra, añadir pilastera de cemento.
Install on rigid ground. On grass or earth, add pilaster cement.

SOLEI



Acabado antracita — Anthracite finish



Tiempo de carga: 8h. Duración carga completa: Hasta 8h.
Loading time: 8h. Full load duration: Up to 8h.

Posibilidad de fijar a suelo — Possibility to fix to the ground

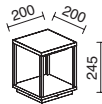
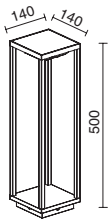

LED SMD 2,2W 23lm 3000K

■ 853A-L0IXIK-04

LED SMD 3,5W 300lm 3000K

■ 853B-L0IXIK-04



Instalar sobre suelo rígido. En césped o tierra, añadir pilastro de cemento.
Install on rigid ground. On grass or earth, add pilaster cement.



Incluye piqueta
Spike included

TECNO
POLIM



Decorative_

LITTA



Video



Acabado blanco o negro
White or black finish.

Cargador USB incluido – USB charger included
5V DC/1A (110/240V 50/60Hz)

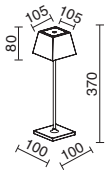

LED SMD 2,2W 200lm 3000K

□ 914B-L0103L-01

■ 914B-L0103L-02



No utilizar mientras se está cargando
Do not use while charging



GLOU



Acabado negro – Black finish

Lamps_P_859



E27 Led/Fluo 15W max.
■ 129E-G05X1A-02



E27 Led/Fluo 23W max.
■ 129F-G05X1A-02



E27 Led/Fluo 30W max.
■ 129G-G05X1A-02



E27 Led/Fluo 30W max.
■ 129H-G05X1A-02



Opciones de instalación
Installation Options



PORTOFINO



TERMO
PLASTIC



Acabado negro – Black finish

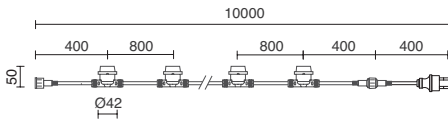

Ampliable por tramos de 12 lámparas/tramo;
máximo 720W totales.
Scalable by sections of 12 lamps/section;
maximum 720w total.

E27 LED 12 lampholder lamp Ø45

■ 858A-G05XIB-02

Complet transparent kit

858AK-632H-01



+



Complet opal kit

858AK-632J-01



+





Classic_

OTTONE



Acabado latón – Brass finish

Lamps P_859

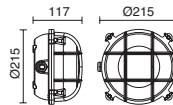
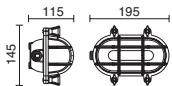

E27 Led/Hal/Fluo 42W max.

573A-G05XIA-34

E27 Led/Hal/Fluo 42W max.

573B-G05XIA-34

MEDI

ALU



Acabado negro o blanco texturado – White or black textured finish

Lamps P_859

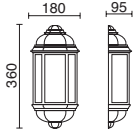

E27 Led/Hal/Fluo 42W max.

- 194B-G05XIA-01T
- 194B-G05XIA-02T

GLASS
TRANS

E27 Led/Hal/Fluo 42W max.

- 194A-G05XIA-01T
- 194A-G05XIA-02T

GLASS
MAT

KEO



ALU

PMMA
MAT



Acabado negro texturado – Black textured finish

Lamps P_859

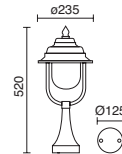
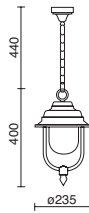
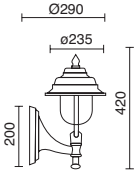

E27 Led/Hal/Fluo 42W max.

- 167B-G05XIA-02T



E27 Led/Hal/Fluo 42W max.

- 167A-G05XIA-02T



E27 Led/Hal/Fluo 42W max.

- 167H-G05XIA-02T



Instalar sobre suelo rígido. En césped o tierra, añadir pilastro de cemento.
Install on rigid ground. On grass or earth, add pilaster cement.

TROM

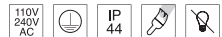

Acabado negro o blanco texturado – White or black textured finish

Lamps P_859

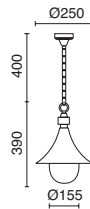
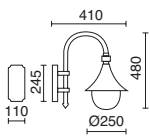

E27 Led/Hal/Fluo 42W max.

□ 332B-G05XIA-01T

■ 332B-G05XIA-02T



E27 Led/Hal/Fluo 42W max.

□ 332G-G05XIA-01T

■ 332G-G05XIA-02T



TROM



Acabado negro o blanco texturado – White or black textured finish

Lamps P_859

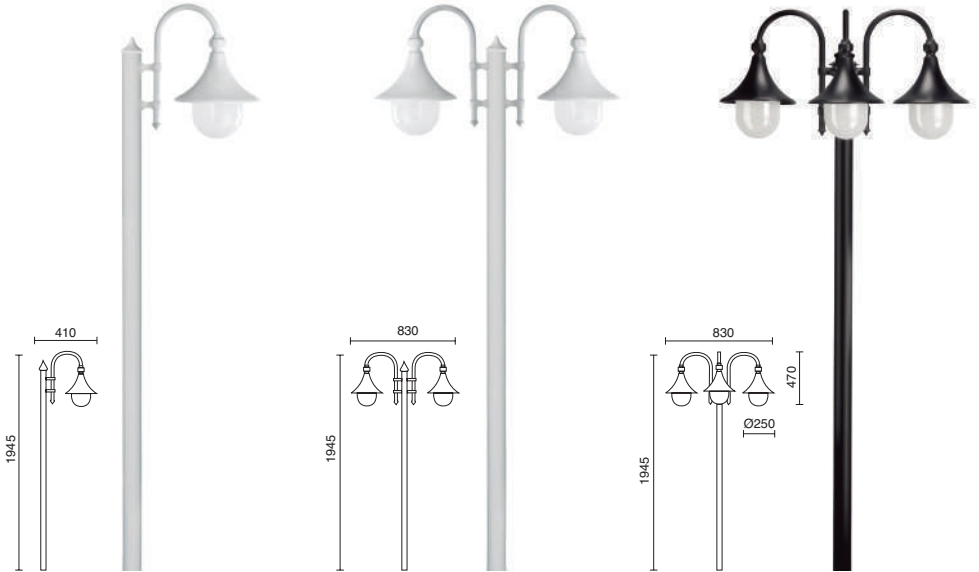

Base y anclaje no incluido – Base and anchor not included

E27 Led/Hal/Fluo 42W max.

□ 332D-G05XIA-01T

■ 332D-G05XIA-02T

2x E27 Led/Hal/Fluo 42W max.

□ 332E-G05XIA-01T

■ 332E-G05XIA-02T

3x E27 Led/Hal/Fluo 42W max.

□ 332F-G05XIA-01T

■ 332F-G05XIA-02T

Bases – Bases

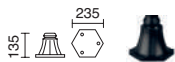

□ Base-VbT

■ Base-VnT



□ Base-NbT

■ Base-NnT

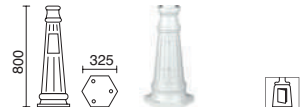

□ Base-RbT

■ Base-RnT

Anclajes
Anchorage



For -Vb/Vn

A02C-004-00



For -Nb/Nn

A02A-004-00



For -Rb/Rn

A02B-004-00



Instalar sobre suelo rígido. En césped o tierra, añadir pilastra de cemento.
Install on rigid ground. On grass or earth, add pilaster cement.

BOOM



Acabado negro o blanco texturado – White or black textured finish

Lamps P_859

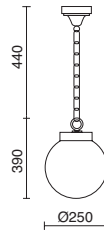
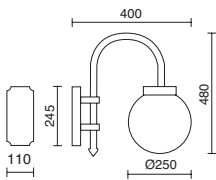

E27 Led/Hal/Fluo 42W max.

□ 036B-G05XIA-01T

■ 036B-G05XIA-02T



E27 Led/Hal/Fluo 42W max.

□ 036A-G05XIA-01T

■ 036A-G05XIA-02T



BOOM

Doble posición
Double position



Acabado negro o blanco texturado – White or black textured finish

Lamps P_859



Base y anclaje no incluido – Base and anchor not included

E27 Led/Hal/Fluo 42W max.

- 036D-G05XIA-01T
- 036D-G05XIA-02T

2x E27 Led/Hal/Fluo 42W max.

- 036E-G05XIA-01T
- 036E-G05XIA-02T

3x E27 Led/Hal/Fluo 42W max.

- 036F-G05XIA-01T
- 036F-G05XIA-02T

Bases – Bases

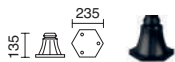

- Base-VbT
- Base-VnT



- Base-NbT
- Base-NnT

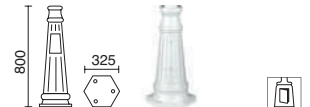

- Base-RbT
- Base-RnT

Anclajes Anchorage



For -Vb/Vn
A02C-004-00



For -Nb/Nn
A02A-004-00



For -Rb/Rn
A02B-004-00

Instalar sobre suelo rígido. En césped o tierra, añadir pilastro de cemento.
Install on rigid ground. On grass or earth, add pilaster cement.

CAST



ALU

110V
240V
ACIP
44

Acabado negro o blanco texturado – White or black textured finish

Lamps P_859

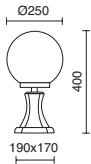

E27 Led/Hal/Fluo 42W max.

 046C-G05XIA-01T

 046C-G05XIA-02T



ALU

110V
240V
ACIP
44

Acabado negro o blanco texturado – White or black textured finish

Lamps P_859

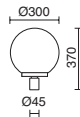
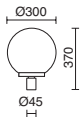
Postes – Poles P_655



E27 Led/Hal/Fluo 42W max.

 046E-G05XIA-01T

 046E-G05XIA-02T

E27 Led/Hal/Fluo 42W max.

 046G-G05XIA-01T

 046G-G05XIA-02T

Instalar sobre suelo rígido. En césped o tierra, añadir pilastra de cemento.
Install on rigid ground. On grass or earth, add pilaster cement.

CAST

ALU



Acabado negro o blanco texturado – White or black textured finish



Globos no incluidos – Globes not included

Postes – Poles

- C07A-11-01T
- C07A-11-02T

- C07B-12-01T
- C07B-12-02T

- C07C-12-01T
- C07C-12-02T

Anclajes Anchorage



For - C07A

A02C-004-00



For - C07B

A02A-004-00



For - C07C

A02B-004-00



Incremento de altura (h400mm)
Height extension (h400mm)

- A08A-C07-01T
- A08A-C07-02T

INDURA GLOBO

By Fumagalli



Acabado negro – Black finish

Lamps P_859

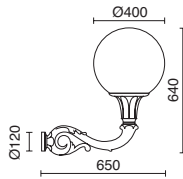
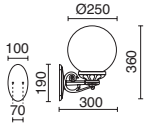

E27 Led/Hal/Fluo 70W max.

■ 151A-G05XIA-02

■ 057B-G05XIA-02



INDURA GLOBO

By Fumagalli



Acabado negro – Black finish

Lamps P_859



E27 Led/Hal/Fluo 70W max.

■ 151H-G05XIA-02



E27 Led/Hal/Fluo 70W max.

■ 148H-G05XIA-02



E27 Led/Hal/Fluo 70W max.

■ 151I-G05XIA-02



E27 Led/Hal/Fluo 70W max.

■ 145I-G05XIA-02



Instalar sobre suelo rígido. En césped o tierra, añadir pilastra de cemento.
Install on rigid ground. On grass or earth, add pilaster cement.

INDURA GLOBO

By Fumagalli



Acabado negro – Black finish

Lamps P_859



E27 Led/Hal/Fluo 70W max.

■ I51D-G05XIA-02

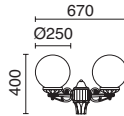

2x E27 Led/Hal/Fluo 70W max.

■ I51E-G05XIA-02



E27 Led/Hal/Fluo 70W max.

■ I48D-G05XIA-02

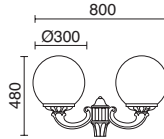

2x E27 Led/Hal/Fluo 70W max.

■ I48E-G05XIA-02

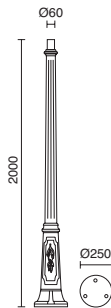
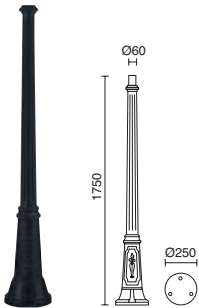

Postes – Poles

■ C08B-3I-02

■ C08C-3I-02



Instalar sobre suelo rígido. En césped o tierra, añadir pilastra de cemento.
Install on rigid ground. On grass or earth, add pilaster cement.

INDURA GLOBO

By Fumagalli



Acabado negro – Black finish

Lamps P_859



E27 Led/Hal/Fluo 105W max.

■ 057D-G05XIA-02

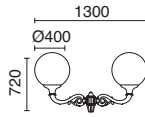

2x E27 Led/Hal/Fluo 105W max.

■ 057E-G05XIA-02

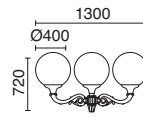

3x E27 Led/Hal/Fluo 105W max.

■ 057F-G05XIA-02

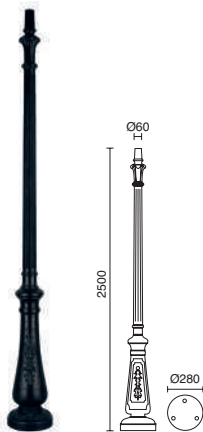

Postes – Poles

■ C10A-3I-02

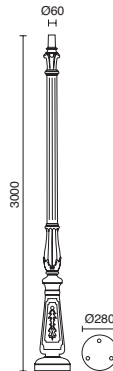

■ C10B-3I-02



Instalar sobre suelo rígido. En césped o tierra, añadir pilastra de cemento.
Install on rigid ground. On grass or earth, add pilaster cement.

VIC



Acabado negro – Black finish

Lamps P_859

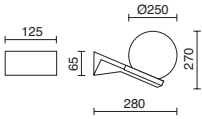

E27 Led/Hal/Fluo 42W max.

■ 344E-G05XIA-02



E27 Led/Hal/Fluo 42W max.

■ 345A-G05XIA-02

■ 345B-G05XIA-02

■ 345C-G05XIA-02

■ 345D-G05XIA-02



E27 Led/Hal/Fluo 42W max.

■ 344A-G05XIA-02

■ 344B-G05XIA-02

■ 344C-G05XIA-02



Recambios – Spare parts



- A23C-I28-01 (Ø200)
- A23D-I28-01 (Ø250)
- A23E-I28-01 (Ø300)
- A23F-I28-01 (Ø400)



Instalar sobre suelo rígido. En césped o tierra, añadir pilastra de cemento.
Install on rigid ground. On grass or earth, add pilaster cement.

GLOBI



Acabado negro o blanco texturado — White or black textured finish

Lamps P_859

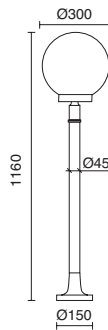
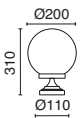

E27 Led/Hal/Fluo 42W max.

□ I27G-G05XIA-01T

■ I27G-G05XIA-02T

E27 Led/Hal/Fluo 42W max.

□ I27K-G05XIA-01T

■ I27K-G05XIA-02T



Instalar sobre suelo rígido. En césped o tierra, añadir pilastra de cemento.
Install on rigid ground. On grass or earth, add pilaster cement.

CLIC-CLAC GLOBO



Acabado blanco o negro – White or black finish

Lamps P_859

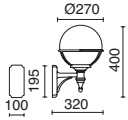

E27 Led/Hal/Fluo 42W max.

061B-G05X1A-01

061B-G05X1A-02

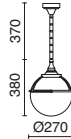

E27 Led/Hal/Fluo 42W max.

061G-G05X1A-01

061G-G05X1A-02



E27 Led/Hal/Fluo 42W max.

061H-G05X1A-01

061H-G05X1A-02

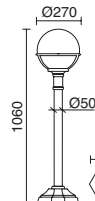

E27 Led/Hal/Fluo 42W max.

061I-G05X1A-01

061I-G05X1A-02



Instalar sobre suelo rígido. En césped o tierra, añadir pilastra de cemento.
Install on rigid ground. On grass or earth, add pilaster cement.

CLIC-CLAC GLOBO

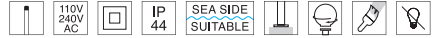

Acabado blanco o negro – White or black finish

Lamps P_859



E27 Led/Hal/Fluo 42W max.

□ 061J-G05XIA-01

■ 061J-G05XIA-02

E27 Led/Hal/Fluo 42W max.

□ 061D-G05XIA-01

■ 061D-G05XIA-02

2x E27 Led/Hal/Fluo 42W max.

□ 061E-G05XIA-01

■ 061E-G05XIA-02



Instalar sobre suelo rígido. En césped o tierra, añadir pilastra de cemento.
Install on rigid ground. On grass or earth, add pilaster cement.

GLOBOS – GLOBES

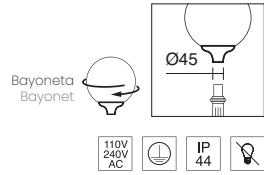
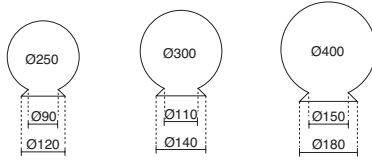

PA

Acabado blanco o negro – White or black finish

Lamps P_859

PRIMA
PRISM

- A23A-128-29 (Ø300)
- A23B-128-29 (Ø400)

PRIMA
OPAL

- A23D-128-01 (Ø250)
- A23E-128-01 (Ø300)
- A23F-128-01 (Ø400)

PRIMA
TRANS

- A23I-128-29 (Ø250)
- A23G-128-29 (Ø300)
- A23H-128-29 (Ø400)

E27 HAL 42W max.



Ø250

- B12J-G05XIA-01T
- B12J-G05XIA-02T

Ø300

- B12K-G05XIA-01T
- B12K-G05XIA-02T

Ø400

- B12L-G05XIA-01T
- B12L-G05XIA-02T

ALU

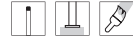

Acabado negro o blanco texturado – White or black textured finish

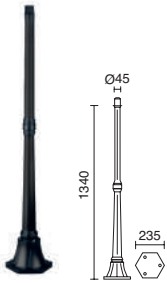

- C07A-11-01T
- C07A-11-02T

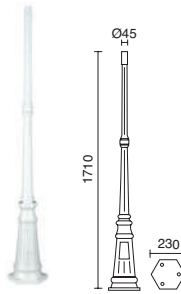

- C07B-12-01T
- C07B-12-02T

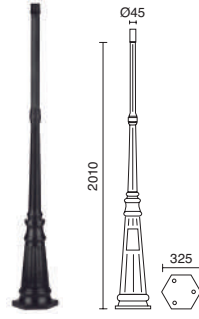

- C07C-12-01T
- C07C-12-02T



Anclajes
Anchorage



For -Vb/Vn

A02C-004-00



For -Nb/Nn

A02A-004-00



For -Rb/Rn

A02B-004-00



Instalar sobre suelo rígido. En césped o tierra, añadir pilastra de cemento.
Install on rigid ground. On grass or earth, add pilaster cement.



Incremento de altura (h400mm)
Height extension (h400mm)

- A08A-C07-01T
- A08A-C07-02T

GLOBOS – GLOBES

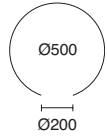
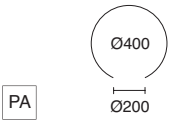

Cierre hermético
Hermetic closure

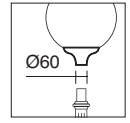

PA

Acabado negro – Black finish

Lamps P_859



PMMA
TRANS



PMMA
PRISM

- A22A-128-29 (Ø400)
- A22B-128-29 (Ø500)

- A22C-128-29 (Ø400)
- A22D-128-29 (Ø500)



PMMA
OPAL



PMMA
PRISM

- A22E-128-01 (Ø400)
- A22F-128-01 (Ø500)

- A22G-128-29 (Ø400)
- A22H-128-29 (Ø500)



Reflector – Reflector
A07A-128-00 *for B12M*

E27 HAL 70W max.

E27 HAL 70W max.

- B12A-G05XIA-02

- B12M-G05XIA-02

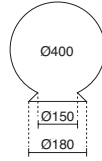
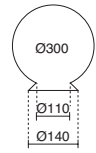
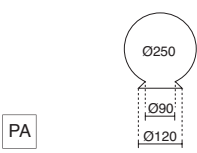

Bayoneta
Bayonet



PA



Acabado negro – Black finish

Lamps P_859



PMMA
PRISM



PMMA
OPAL



PMMA
TRANS

- A23A-128-29 (Ø300)
- A23B-128-29 (Ø400)

- A23D-128-01 (Ø250)
- A23E-128-01 (Ø300)
- A23F-128-01 (Ø400)

- A23I-128-29 (Ø250)
- A23G-128-29 (Ø300)
- A23H-128-29 (Ø400)

E27 HAL 70W max.



- B12F-G05XIA-02 (Ø250)
- B12G-G05XIA-02 (Ø300)
- B12H-G05XIA-02 (Ø400)

POSTES — POLES

By Fumagalli



RESIN

SEA SIDE
SUITABLE

Acabado negro — Black finish

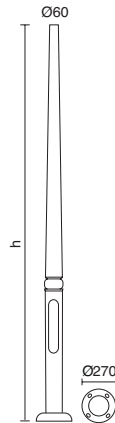
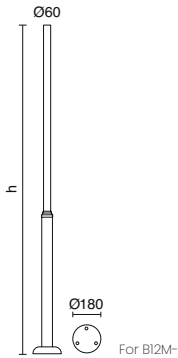
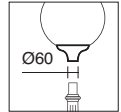
Bayoneta
Bayonet

Postes — Poles

- C06A-31-02 (h2000)
- C06B-31-02 (h2400)



- C04A-32-02 (h3000)
- C04B-32-02 (h3500)
- C04C-32-02 (h4000)
- C04D-32-02 (h4500)
- C04E-32-02 (h5000)



Instalar sobre suelo rígido. En césped o tierra, añadir pilastra de cemento.
Install on rigid ground. On grass or earth, add pilaster cement.

POSTES — POLES

ACER



Acabado acero cincado – Zinc-plated Steel finish

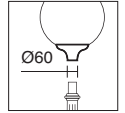
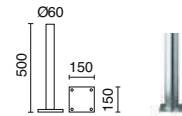
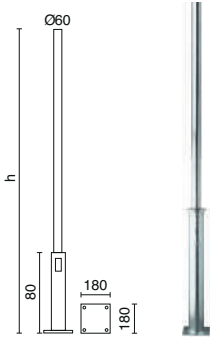

Es necesario pintar
It is necessary to paint

Postes — Poles

■ C30E-32-38 (h2500)

■ C30F-32-38 (h3000)

■ C30D-31-38 (h2000)

■ C30E-31-38 (h2500)

■ C30F-31-38 (h3000)

■ C30B-31-38



Anclajes Anchorages



A02G-004-00



A02F-004-00

ALU
ANOD

Acabado negro o aluminio anodizado – Black or anodised aluminium finish



Caja de conexión opcional
Optional junction box

500V 80A D01/E14-16A (273x90x76cm)

B03F-X33X1A-29



Anclajes Anchorages



A02D-004-00

Postes — Poles

■ C02B-32-02 (h3000)

■ C02C-32-02 (h3500)

■ C02D-32-02 (h4000)

■ C02F-32-02 (h5000)

■ C03B-32-39 (h3000)

■ C03C-32-39 (h3500)

■ C03D-32-39 (h4000)

■ C03F-32-39 (h5000)

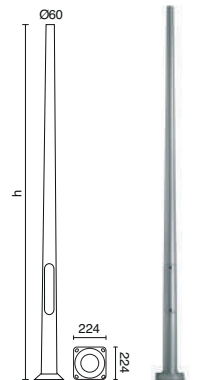

Instalar sobre suelo rígido. En césped o tierra, añadir pilastera de cemento.
Install on rigid ground. On grass or earth, add pilaster cement.

GLOBOS – GLOBES



Acabado negro texturado – Black textured finish

Lamps P_859



A23B-128-29

PMMA
PRISM

A23F-128-01

PMMA
OPAL

A23H-128-29

PMMA
TRANS

E27 HAL 70W max.

■ BI2I-G05XIA-02T

ALU

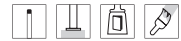

Acabado negro – Black finish

Lamps P_859

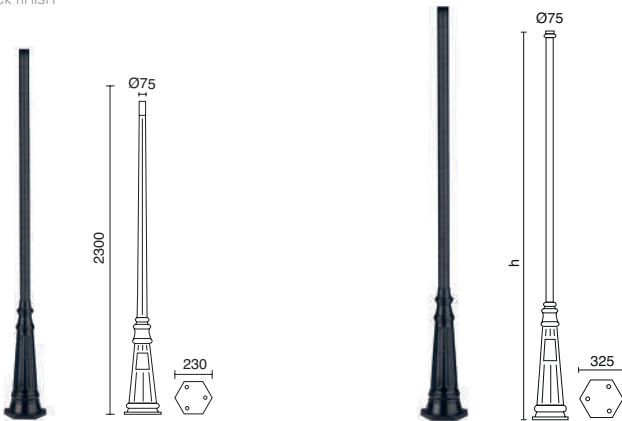

Postes – Poles

■ C07D-42-02T (h2300)

■ C07E-42-02T (h2600)

■ C07F-42-02T (h2900)

Anclajes
Anchorage

A02A-004-00



A02B-004-00



Instalar sobre suelo rígido. En césped o tierra, añadir pilastra de cemento.
Install on rigid ground. On grass or earth, add pilaster cement.

ROUND



Acabado antracita – Anthracite finish

Lamps P_859

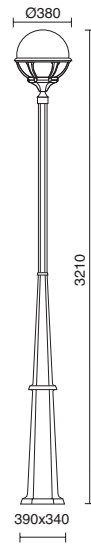

E27 Led/Hal/Fluo 105W max.

■ 405C-G05XIA-04



E27 Led/Hal/Fluo 105W max.

■ 405D-G05XIA-04



Anclajes Anchorage



A02A-406-00



Instalar sobre suelo rígido. En césped o tierra, añadir pilastra de cemento.
Install on rigid ground. On grass or earth, add pilaster cement.



Reflector antideslumbrantes
Anti-glare reflector

A07A-406-39

QUADRA



Acabado antracita — Anthracite finish

Lamps P_859

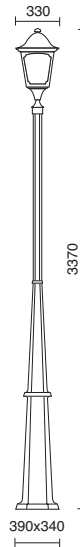
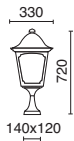

E27 Led/Hal/Fluo 105W max.

■ 406C-G05XIA-04



E27 Led/Hal/Fluo 105W max.

■ 406D-G05XIA-04



Anclajes
Anchorage



A02A-406-00



Instalar sobre suelo rígido. En césped o tierra, añadir pilastra de cemento.
Install on rigid ground. On grass or earth, add pilaster cement.



Reflector antideslumbrantes
Anti-glare reflector

A07A-406-39



HORATIVS CLAVDIVS CAPR

ROB

ALU

110V
240V
ACIP
44

Acabado negro o blanco texturado – White or black textured finish

Lamps P_859

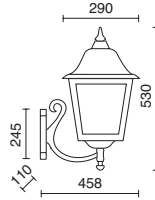
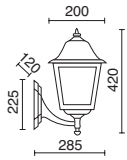

E27 Led/Hal/Fluo 42W max.

□ 264C-G05XIA-01T

■ 264C-G05XIA-02T



E27 Led/Hal/Fluo 70W max.

□ 264E-G05XIA-01T

■ 264E-G05XIA-02T



□ 264D-G05XIA-01T

■ 264D-G05XIA-02T

Adaptador de esquina
 Corner adaptor

□ A06A-004-01

■ A06A-004-02

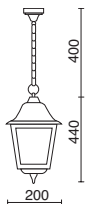

E27 Led/Hal/Fluo 42W max.

□ 264A-G05XIA-01T

■ 264A-G05XIA-02T

GLASS
MAT

□ 264B-G05XIA-01T

■ 264B-G05XIA-02T

GLASS
TRANS

ROB

ALU

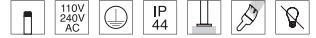

Acabado negro o blanco texturado – White or black textured finish

Lamps P_859



E27 Led/Hal/Fluo 42W max.

- 264G-G05X1A-01T
- 264G-G05X1A-02T



- 264H-G05X1A-01T
- 264H-G05X1A-02T

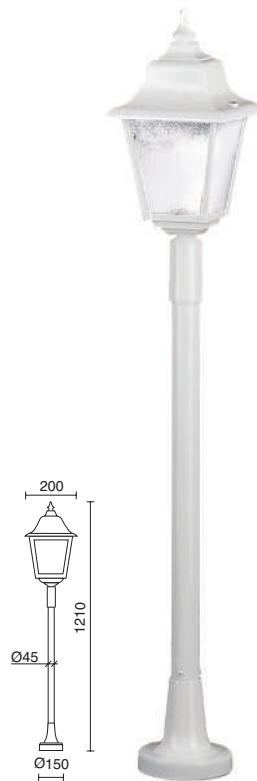

E27 Led/Hal/Fluo 42W max.

- 264K-G05X1A-01T
- 264K-G05X1A-02T



- 264L-G05X1A-01T
- 264L-G05X1A-02T



Instalar sobre suelo rígido. En césped o tierra, añadir pilastra de cemento.
Install on rigid ground. On grass or earth, add pilaster cement.

ROB



ALU

110V
240V
ACIP
44

Acabado negro o blanco texturado – White or black textured finish

Lamps P_859

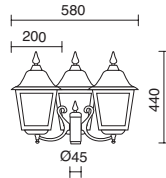
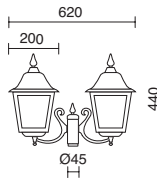

E27 Led/Hal/Fluo 70W max.

- 264M-G05XIA-01T
- 264M-G05XIA-02T

2x E27 Led/Hal/Fluo 42W max.

- 264O-G05XIA-01T
- 264O-G05XIA-02T

3x E27 Led/Hal/Fluo 42W max.

- 264Q-G05XIA-01T
- 264Q-G05XIA-02T



- 264N-G05XIA-01T
- 264N-G05XIA-02T

- 264P-G05XIA-01T
- 264P-G05XIA-02T

- 264R-G05XIA-01T
- 264R-G05XIA-02T



POSTES — POLES

ALU



Acabado negro o blanco texturado — White or black textured finish

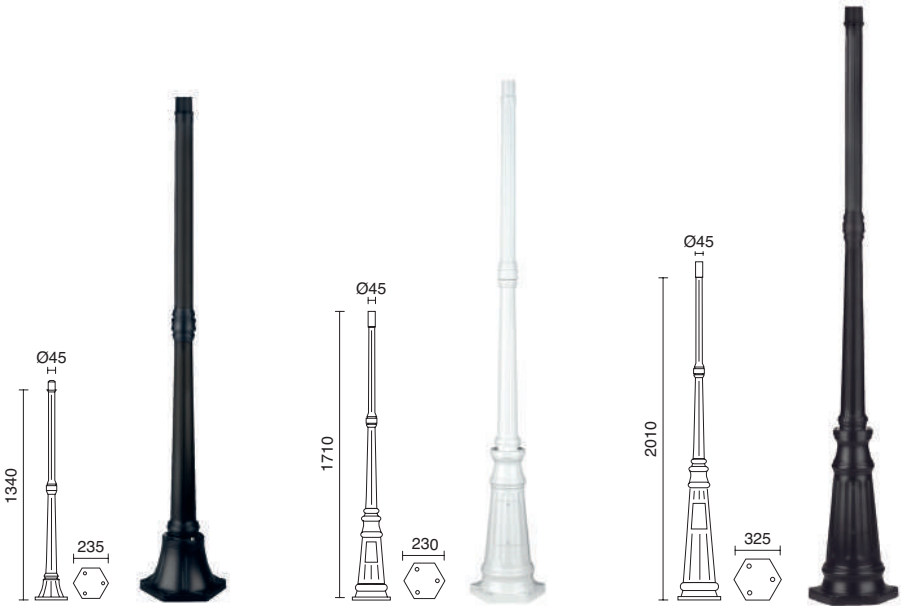

Postes — Poles

□ C07A-11-01T

■ C07A-11-02T

□ C07B-12-01T

■ C07B-12-02T



□ C07C-12-01T

■ C07C-12-02T



Anclajes Anchorage

For - C07A

A02C-004-00

For - C07B

A02A-004-00

For - C07C

A02B-004-00



Incremento de altura (h400mm)
Height extension (h400mm)

□ A08A-C07-01T

■ A08A-C07-02T



Instalar sobre suelo rígido. En césped o tierra, añadir pilastra de cemento.
Install on rigid ground. On grass or earth, add pilaster cement.

CLIC-CLAC 4



Acabado blanco o negro – White or black finish

Lamps P_859



E27 Led/Hal/Fluo 42W max.

□ 059A-G05XIA-01

■ 059A-G05XIA-02



E27 Led/Hal/Fluo 42W max.

□ 059G-G05XIA-01

■ 059G-G05XIA-02



E27 Led/Hal/Fluo 42W max.

□ 059H-G05XIA-01

■ 059H-G05XIA-02

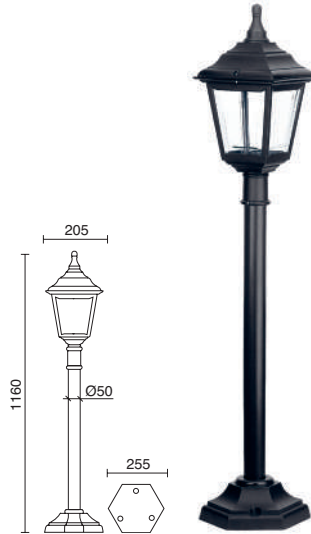

E27 Led/Hal/Fluo 42W max.

□ 059I-G05XIA-01

■ 059I-G05XIA-02



 Instalar sobre suelo rígido. En césped o tierra, añadir pilastra de cemento.
 Install on rigid ground. On grass or earth, add pilaster cement.

CLIC-CLAC 4



Acabado blanco o negro – White or black finish

Lamps P_859



E27 Led/Hal/Fluo 42W max.

□ 059J-G05XIA-01

■ 059J-G05XIA-02

E27 Led/Hal/Fluo 42W max.

□ 059C-G05XIA-01

■ 059C-G05XIA-02

E27 Led/Hal/Fluo **2x** 42W max.

□ 059B-G05XIA-01

■ 059B-G05XIA-02



Instalar sobre suelo rígido. En césped o tierra, añadir pilastra de cemento.
Install on rigid ground. On grass or earth, add pilaster cement.

VILLA CHAP



Acabado negro texturado – Black textured finish

Lamps P_859

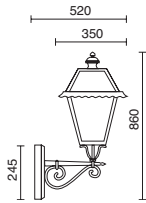

E27 Led/Hal/Fluo 70W max.

■ 348B-G05XIA-02T

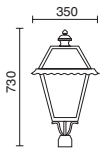

E27 Led/Hal/Fluo 70W max.

■ 348D-G05XIA-02T

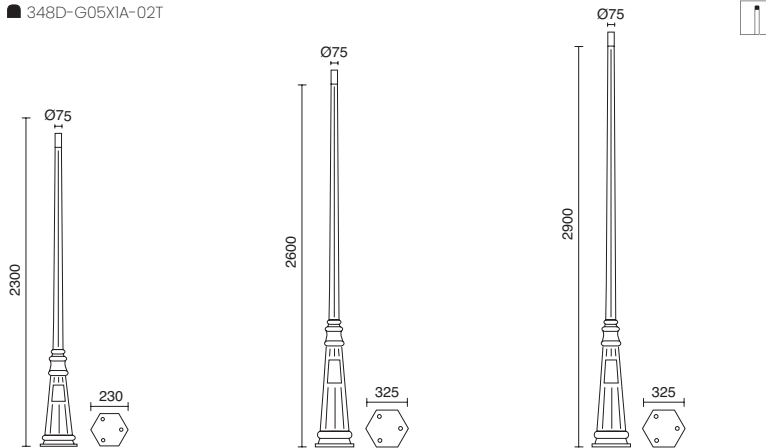

Postes – Poles

■ C07D-42-02T

■ C07E-42-02T

■ C07F-42-02T



Anclajes
Anchorage

For C07D-

A02A-004-00



For C07E- / C07F-

A02B-004-00



Instalar sobre suelo rígido. En césped o tierra, añadir pilastra de cemento.
Install on rigid ground. On grass or earth, add pilaster cement.

CITY INDURA

By Fumagalli



Acabado negro – Black finish

Lamps P_859

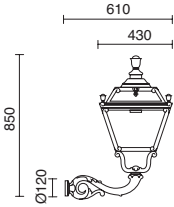

E27 Led/Hal/Fluo 70W max.

■ 056B-G05X1A-02

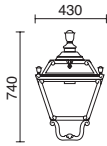

E27 Led/Hal/Fluo 70W max.

■ 056D-G05X1A-02

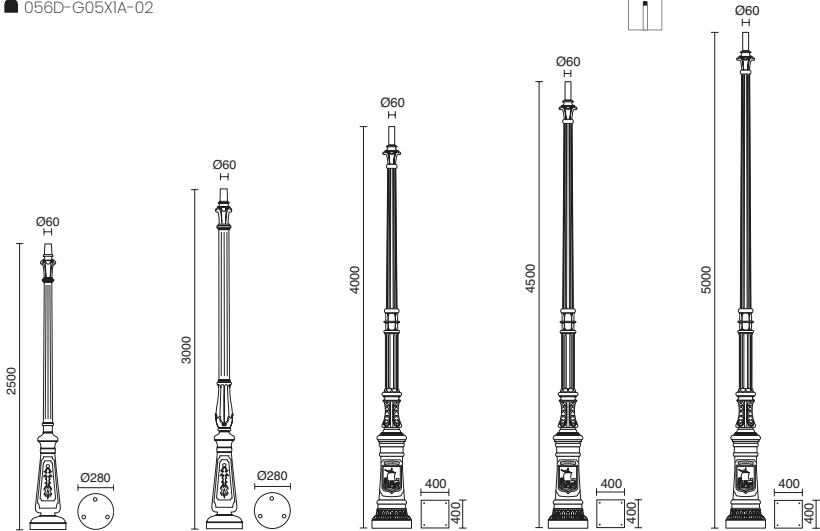

Postes – Poles

■ C10A-3I-02

■ C10B-3I-02

■ C12A-32-02

■ C12B-32-02

■ C12C-32-02



Instalar sobre suelo rígido. En césped o tierra, añadir pilastra de cemento.
Install on rigid ground. On grass or earth, add pilaster cement.

INDURA MEDIUM 4

By Fumagalli



Acabado negro – Black finish

Lamps P_859



E27 Led/Hal/Fluo 42W max.

■ I46B-G05X1A-02

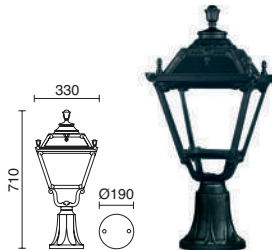
E27
(Basket diffuser)

E27 Led/Hal/Fluo 42W max.

■ I46H-G05X1A-02

E27
(Basket diffuser)

E27 Led/Hal/Fluo 70W max.

■ I46D-G05X1A-02



2x E27 Led/Hal/Fluo 70W max.

■ I46E-G05X1A-02

E27
(Basket diffuser)

GX53 LED T2 4x10W

■ I46D-G31X1A-02

2x GX53 LED T2 4x10W

■ I46E-G31X1A-02

GX53
(Flat diffuser)

No es posible Kit de sustitución LED. La luminaria está construida específicamente para portalámparas GX53.
Substitution LED KIT not available. Fitting is meant for GX53 lamp holder.

INDURA MEDIUM 4

By Fumagalli

RESIN

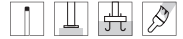

Acabado negro – Black finish

Lamps P_859

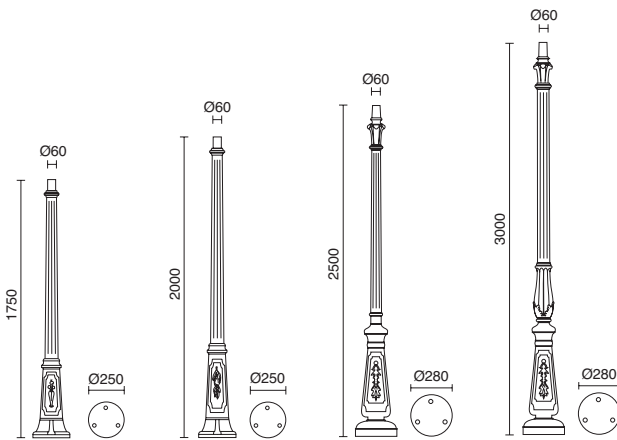

Postes – Poles

h1750

■ C08B-3I-02

h2000

■ C08C-3I-02

h2500

■ C10A-3I-02

h3000

■ C10B-3I-02



Instalar sobre suelo rígido. En césped o tierra, añadir pilastra de cemento.
Install on rigid ground. On grass or earth, add pilaster cement.

INDURA MINI 4

By Fumagalli



Acabado negro – Black finish

Lamps P_859

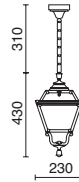
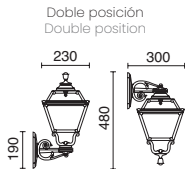

E27 Led/Hal/Fluo 42W max.

■ 149B-G05X1A-02



E27 Led/Hal/Fluo 42W max.

■ 149G-G05X1A-02



E27 Led/Hal/Fluo 42W max.

■ 149H-G05X1A-02

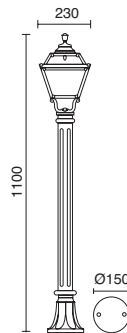

E27 Led/Hal/Fluo 42W max.

■ 149I-G05X1A-02



 Instalar sobre suelo rígido. En césped o tierra, añadir pilastra de cemento.
Install on rigid ground. On grass or earth, add pilaster cement.

INDURA MINI 6

By Fumagalli



Acabado negro – Black finish

Lamps P_859

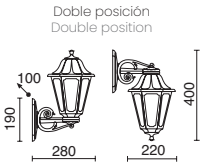

E27 Led/Hal/Fluo 42W max.

■ I50B-G05XIA-02



E27 Led/Hal/Fluo 42W max.

■ I50G-G05XIA-02

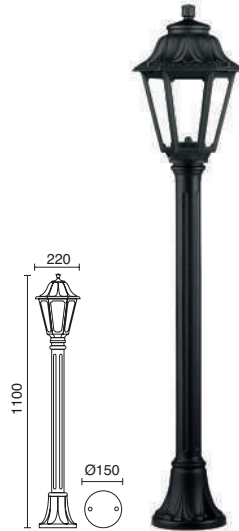

E27 Led/Hal/Fluo 42W max.

■ I50H-G05XIA-02

E27 Led/Hal/Fluo 42W max.

■ I50I-G05XIA-02



Instalar sobre suelo rígido. En césped o tierra, añadir pilastra de cemento.
Install on rigid ground. On grass or earth, add pilaster cement.

INDURA MEDIUM 6

By Fumagalli



Acabado negro – Black finish

Lamps P_859



E27 Led/Hal/Fluo 42W max.

■ I47A-G05XIA-02



E27 Led/Hal/Fluo 42W max.

■ I47B-G05XIA-02



E27 Led/Hal/Fluo 42W max.

■ I47H-G05XIA-02

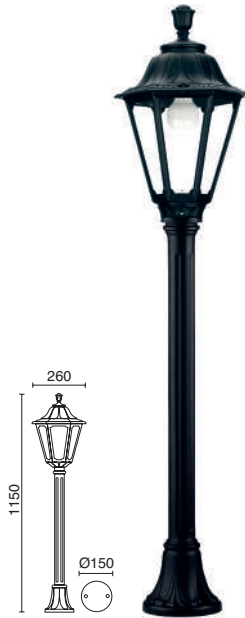

E27 Led/Hal/Fluo 42W max.

■ I47I-G05XIA-02



Instalar sobre suelo rígido. En césped o tierra, añadir pilastra de cemento.
Install on rigid ground. On grass or earth, add pilaster cement.



INDURA MEDIUM 6

By Fumagalli



110V
240V
AC



IP
55

U.V.
TREATED



SEA SIDE
SUITABLE



Acabado negro – Black finish

Lamps P_859

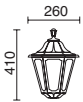

E27 Led/Hal/Fluo 42W max.

■ I47D-G05XIA-02

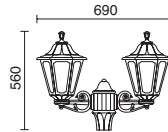

2x E27 Led/Hal/Fluo 42W max.

■ I47E-G05XIA-02

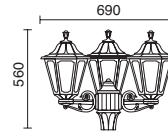

3x E27 Led/Hal/Fluo 42W max.

■ I47F-G05XIA-02

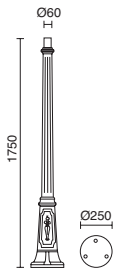

Postes – Poles

■ C08B-3I-02

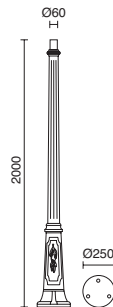

■ C08C-3I-02



Instalar sobre suelo rígido. En césped o tierra, añadir pilastro de cemento.
Install on rigid ground. On grass or earth, add pilaster cement.

INDURA BIG 6

By Fumagalli



Acabado negro – Black finish

Lamps P_859

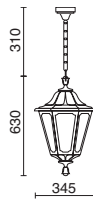
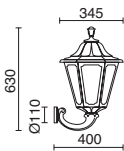

E27 Led/Hal/Fluo 42W max.

■ I44B-G05XIA-02



E27 Led/Hal/Fluo 42W max.

■ I44G-G05XIA-02



INDURA BIG 6

By Fumagalli



Acabado negro – Black finish

Lamps P_859

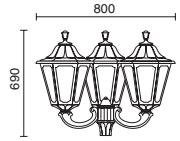
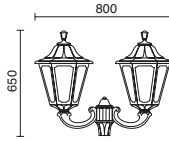
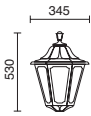

E27 Led/Hal/Fluo 70W max.

■ I44D-G05XIA-02

E27 Led/Hal/Fluo 2x 70W max.

■ I44E-G05XIA-02

E27 Led/Hal/Fluo 3x 70W max.

■ I44F-G05XIA-02

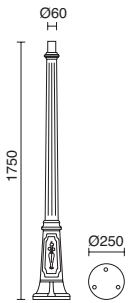

■ C08B-3I-02

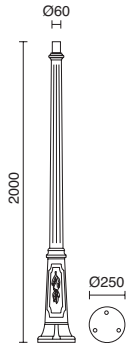

■ C08C-3I-02

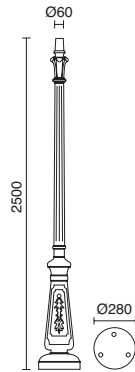

■ C10A-3I-02

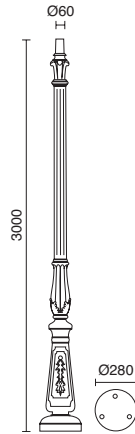

■ C10B-3I-02



Postes – Poles



Instalar sobre suelo rígido. En césped o tierra, añadir pilastro de cemento.
Install on rigid ground. On grass or earth, add pilaster cement.

CLIC-CLAC 6



Acabado blanco o negro – White or black finish

Lamps P_859

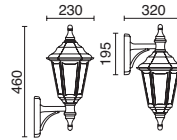
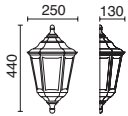

E27 Led/Hal/Fluo 42W max.

- 060A-G05XIA-01
- 060A-G05XIA-02

E27 Led/Hal/Fluo 42W max.

- 060B-G05XIA-01
- 060B-G05XIA-02

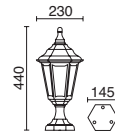
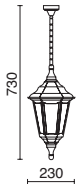

E27 Led/Hal/Fluo 42W max.

- 060G-G05XIA-01
- 060G-G05XIA-02



E27 Led/Hal/Fluo 42W max.

- 060H-G05XIA-01
- 060H-G05XIA-02



Instalar sobre suelo rígido. En césped o tierra, añadir pilastra de cemento.
Install on rigid ground. On grass or earth, add pilaster cement.

CLIC-CLAC 6



Acabado blanco o negro – White or black finish

Lamps P_859



E27 Led/Hal/Fluo 42W max.

□ 060J-G05XIA-01

■ 060J-G05XIA-02

E27 Led/Hal/Fluo 42W max.

□ 060D-G05XIA-01

■ 060D-G05XIA-02

E27 Led/Hal/Fluo 2x 42W max.

□ 060E-G05XIA-01

■ 060E-G05XIA-02



Instalar sobre suelo rígido. En césped o tierra, añadir pilastra de cemento.
Install on rigid ground. On grass or earth, add pilaster cement.

ELITE 6

ALU



Acabado blanco o negro – White or black finish

Lamps P_859



E14 Led/Hal/Fluo 42W max.

- 096A-G04XIA-01T
- 096A-G04XIA-02T



E27 Led/Hal/Fluo 42W max.

- 096D-G05XIA-01T
- 096D-G05XIA-02T

GLASS
MAT

- 096E-G05XIA-01T
- 096E-G05XIA-02T

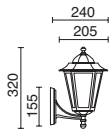
GLASS
TRANS

E14 Led/Hal/Fluo 42W max.

- 096F-G05XIA-01T
- 096F-G05XIA-02T

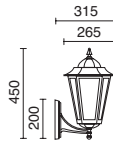

E27 Led/Hal/Fluo 42W max.

- 096G-G05XIA-01T
- 096G-G05XIA-02T

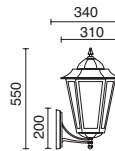

E27 Led/Hal/Fluo 42W max.

- 096I-G05XIA-01T
- 096I-G05XIA-02T

GLASS
MAT

- 096H-G05XIA-01T
- 096H-G05XIA-02T

- 096J-G05XIA-01T
- 096J-G05XIA-02T

GLASS
TRANS

For h450 & h550



Adaptador de esquina
Corner adaptor

- A06A-004-01
- A06A-004-02

ELITE 6

ALU

110V
240V
AC



IP
44



Acabado blanco o negro – White or black finish

Lamps P_859

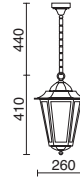
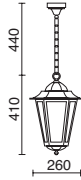

E27 Led/Hal/Fluo 70W max.

□ 096B-G05XIA-01T

■ 096B-G05XIA-02T



E27 Led/Hal/Fluo 70W max.

□ 096C-G05XIA-01T

■ 096C-G05XIA-02T

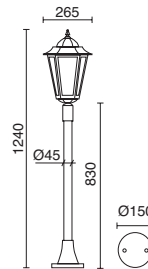
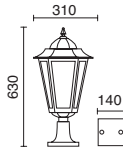
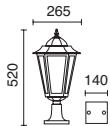

E27 Led/Hal/Fluo 42W max.

□ 096K-G05XIA-01T

■ 096K-G05XIA-02T

E27 Led/Hal/Fluo 42W max.

□ 096M-G05XIA-01T

■ 096M-G05XIA-02T

E27 Led/Hal/Fluo 42W max.

□ 096O-G05XIA-01T

■ 096O-G05XIA-02T



□ 096L-G05XIA-01T

■ 096L-G05XIA-02T

□ 096N-G05XIA-01T

■ 096N-G05XIA-02T

□ 096P-G05XIA-01T

■ 096P-G05XIA-02T



Instalar sobre suelo rígido. En césped o tierra, añadir pilastra de cemento.
Install on rigid ground. On grass or earth, add pilaster cement.

ELITE 6



ALU

110V
240V
ACIP
44

Acabado negro o blanco texturado – White or black textured finish

Lamps P_859

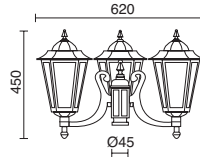
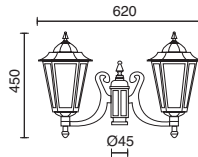

E27 Led/Hal/Fluo 42W max.

□ 096Q-G05XIA-01T

■ 096Q-G05XIA-02T

2x E27 Led/Hal/Fluo 42W max.

□ 096S-G05XIA-01T

■ 096S-G05XIA-02T

3x E27 Led/Hal/Fluo 42W max.

□ 096U-G05XIA-01T

■ 096U-G05XIA-02T



□ 096R-G05XIA-01T

■ 096R-G05XIA-02T

□ 096T-G05XIA-01T

■ 096T-G05XIA-02T

□ 096V-G05XIA-01T

■ 096V-G05XIA-02T



POSTES — POLES

ALU



Acabado negro o blanco texturado — White or black textured finish



Postes — Poles

□ C07A-11-01T
■ C07A-11-02T

□ C07B-12-01T
■ C07B-12-02T



□ C07C-12-01T
■ C07C-12-02T



Anclajes Anchorage

For - C07A
A02C-004-00



For - C07B
A02A-004-00



For - C07C
A02B-004-00



Incremento de altura (h400mm)
Height extension (h400mm)

□ A08A-C07-01T
■ A08A-C07-02T



Instalar sobre suelo rígido. En césped o tierra, añadir pilastro de cemento.
Install on rigid ground. On grass or earth, add pilaster cement.

VILLA BIG



Acabado negro texturado – Black textured finish

Lamps P_859

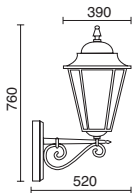

E27 Led/Hal/Fluo 70W max.

■ 346B-G05XIA-02T

VILLA BIG



Acabado negro texturado – Black textured finish

Lamps P_859



E27 Led/Hal/Fluo 70W max.

■ 346D-G05XIA-02T

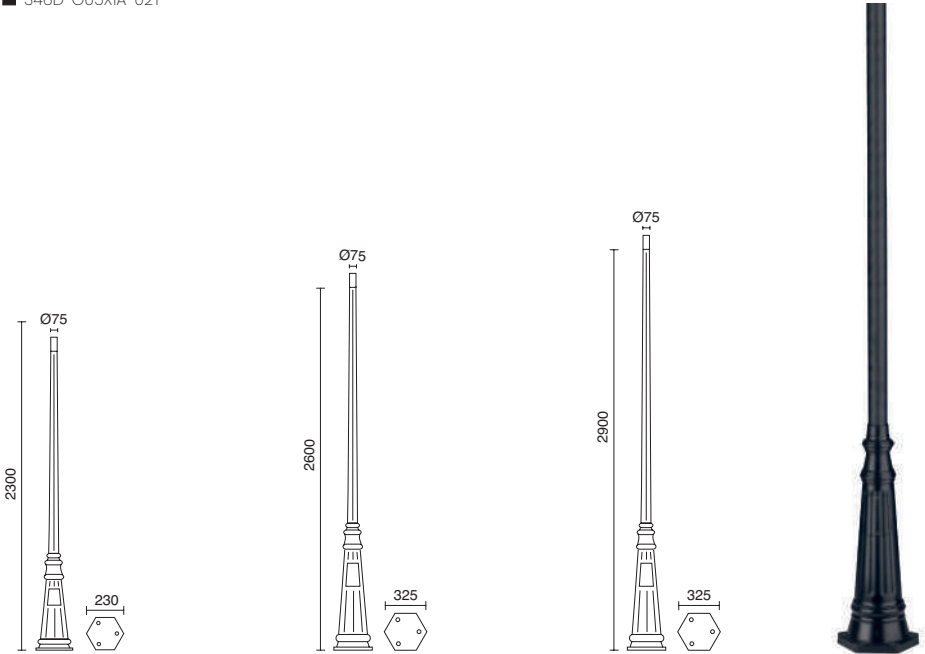

Postes – Poles

■ C07D-42-02T

■ C07E-42-02T

■ C07F-42-02T



Anclajes Anchorages

For - C07D

A02A-004-00



For - C07E / C07F

A02B-004-00



Instalar sobre suelo rígido. En césped o tierra, añadir pilastra de cemento.
Install on rigid ground. On grass or earth, add pilaster cement.

GUNTHER Ø48

By Fumagalli



Acabado negro – Black finish

Lamps P_858

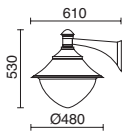

GX53 LED T2 (6x 10W)

■ 407B-G3IXIA-02

GUNTHER Ø48

By Fumagalli



Acabado negro – Black finish

Lamps P_858

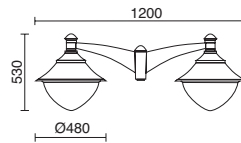
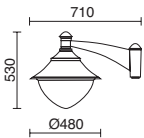

GX53 LED T2 (6x 10W)

2x GX53 LED T2 (6x 10W)

■ 407D-G3IXIA-02

■ 407E-G3IXIA-02

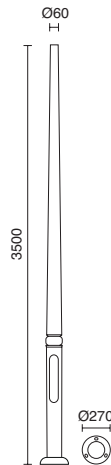
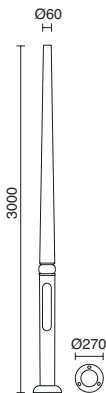

Postes – Poles

■ C04A-32-02

■ C04B-32-02



Instalar sobre suelo rígido. En césped o tierra, añadir pilastra de cemento.
Install on rigid ground. On grass or earth, add pilaster cement.



GUNTHER Ø60

By Fumagalli

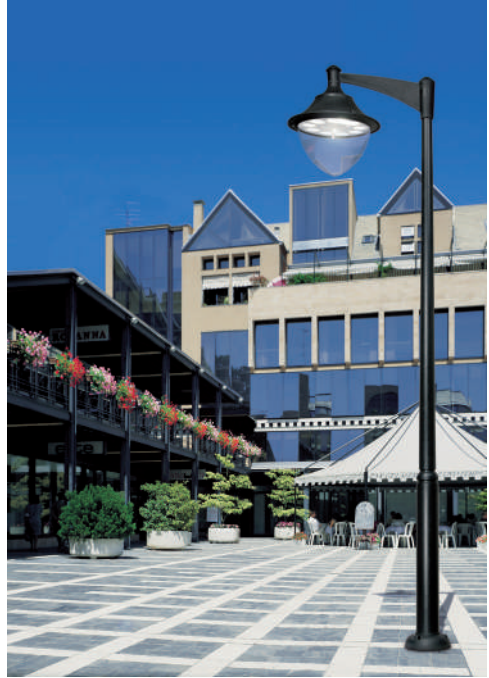

Acabado negro – Black finish

Lamps P_858

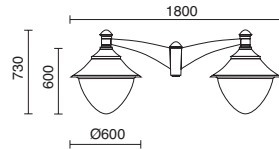
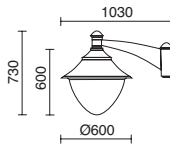
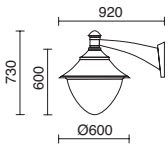

GX53 LED T2 (9x 10W)

■ 408B-G3IXIA-02



GX53 LED T2 (9x 10W)

■ 408D-G3IXIA-02

2x GX53 LED T2 (9x 10W)

■ 408E-G3IXIA-02



GUNTHER TOP

By Fumagalli



Acabado negro – Black finish

Lamps P_858

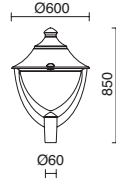

GX53 LED T2 (9x 10W)

■ 655A-G31XIA-02

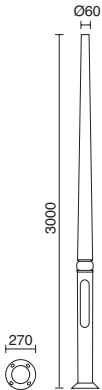

Postes
Poles



■ C04A-32-02

■ C04B-32-02

■ C04C-32-02

■ C04D-32-02



Instalar sobre suelo rígido. En césped o tierra, añadir pilastra de cemento.
Install on rigid ground. On grass or earth, add pilaster cement.

Cristher lighting

Exterior arquitectónico | Alta gama | Personalización

Cristher es la gama de iluminación exterior pensada para entornos arquitectónicos y residenciales que exigen un alto nivel de diseño y calidad. Sus productos destacan por su cuidada estética, su variedad de formatos, unos acabados que garantizan durabilidad, y su capacidad de personalización bajo demanda ofreciendo una amplia gama de opciones. Fabricada en proximidad, combina diseño responsable, excelencia técnica y compromiso ambiental, convirtiéndose en la elección ideal para proyectos que buscan soluciones premium a medida con exigencia técnica y sensibilidad estética.

Architectural outdoor | High-end | Custom solutions

Cristher is the outdoor lighting range designed for architectural and residential settings that demand a high level of design and quality. Its products stand out for their refined aesthetics, variety of formats, durable finishes, and customisation capabilities, offering a wide array of options on request. Locally manufactured, Cristher combines responsible design, technical excellence, and environmental commitment, making it the ideal choice for premium, bespoke projects with high technical demands and aesthetic sensitivity.



Wall Lights_

DAU

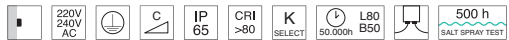

Acabado negro – Black finish

Opciones de acabado a consultar – Finish options available for consultation

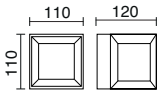

LED SMD 8W

■ 1090A-L4108BBF-02

K SELECT	2700K	920lm
	3200K	960lm
	4000K	1020lm

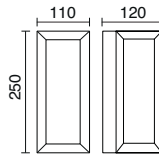

LED SMD 15W

■ 1090B-L4115BBF-02

K SELECT	2700K	1955lm
	3000K	2035lm
	4000K	2160lm



MinniM

DUOMO



Acabado antracita – Anthracite finish

Drivers P_862

Opciones de acabado a consultar – Finish options available for consultation

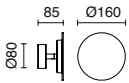

LED SMD 11W 1420lm **2700K**

LED SMD 11W 1420lm **3000K**

LED SMD 11W 1510lm **4000K**

■ 1069A-L3011FC0-04

■ 1069A-L3111FC0-04

■ 1069A-L3311FC0-04



LED SMD 11W 1300lm **3000K**

■ 1069A-L3112AC0-04



Alimentador – Power supply

100W (max. 7 unit.)

B02R-X33A1F-01

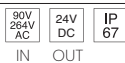

P_810





BUCKET



Acabado antracita – Anthracite finish

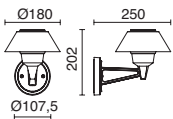

LED SMD 10,5W 1680lm **3000K**

LED SMD 10,5W 1770lm **4000K**

■ 976A-L3110B-04

■ 976A-L3310B-04

■ 976A-L31RCB-04

■ 976A-L33RCB-04





DION

by Jordi Blasi



Video



Acabado antracita – Anthracite finish

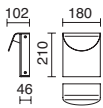

LED SMD 8,5W 1500lm 3000K

- 926D-L3109B-80
- 926D-L3109B-81
- 926D-L3109B-82
- 926D-L3109B-83

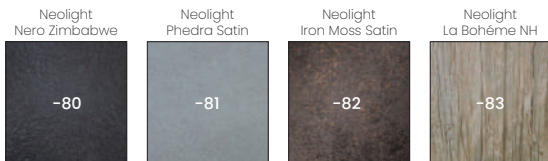



STONE



Conector IP67 incluido
IP67 connector included

Lamps P_860

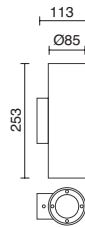
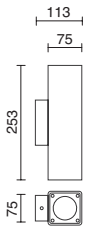

GU10 2x 12W max.

- 965A-G21X1A-NB
- 965A-G21X1A-NN
- 965A-G21X1A-NR
- 965A-G21X1A-NW

GU10 2x 12W max.

- 965B-G21X1A-NB
- 965B-G21X1A-NN
- 965B-G21X1A-NR
- 965B-G21X1A-NW



No utilizar atornillador mecánico
Never use mechanical screwdriver

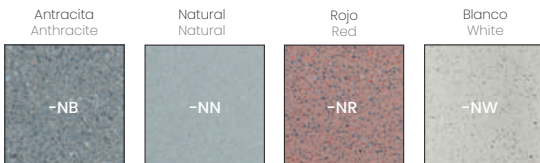



STONE

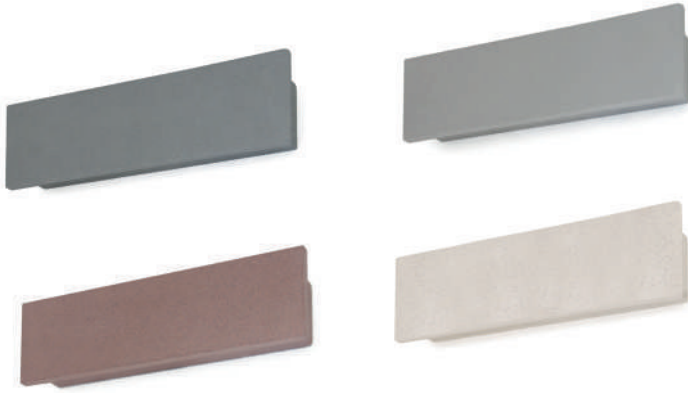

Adaptable a iluminación mono emisión.
Adaptable to mono emission lighting.

Conector IP67 incluido
IP67 connector included

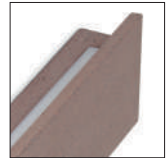
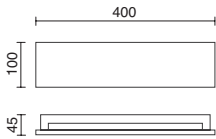

LED SMD 10W 2x 475lm 3000K

- 965C-L3112A-NB
- 965C-L3112A-NN
- 965C-L3112A-NR
- 965C-L3112A-NW



No utilizar atornillador mecánico
Never use mechanical screwdriver

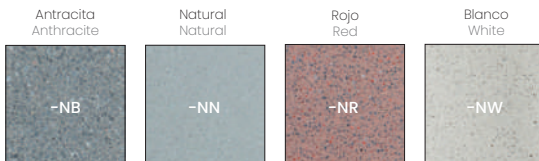



LANCE

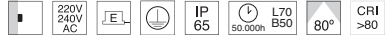

Acabado antracita – Anthracite finish

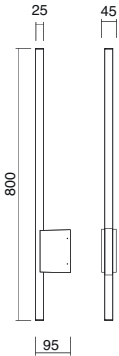

LED SMD 10,5W 1150lm **3000K**

■ 1024B-L3112BX0-04

■ 1024B-L3112BXD-04

LED SMD 10,5W 1280lm **4000K**

■ 1024B-L3312BX0-04

■ 1024B-L3312BXD-04

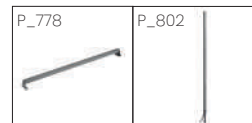



ISORA

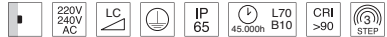
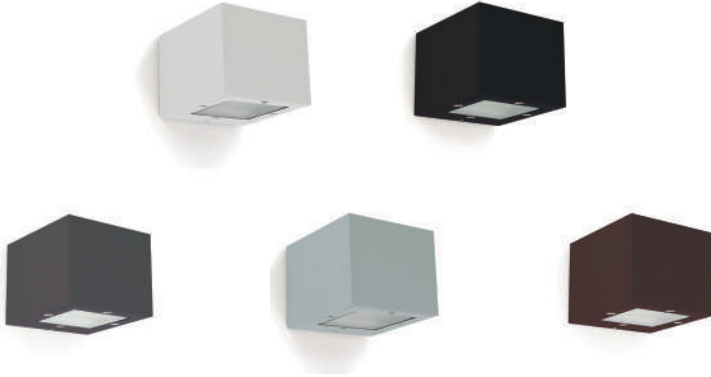

Acabado blanco, negro, gris, antracita o marrón cobrizo
White, black, grey, anthracite or copper brown finish

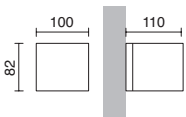

2700K

LED COB AC 4W 315lm

- 157A-L3805B-01
- 157A-L3805B-02
- 157A-L3805B-03
- 157A-L3805B-04
- 157A-L3805B-91

2x LED COB AC 4W 315lm

- 157B-L38G8B-01
- 157B-L38G8B-02
- 157B-L38G8B-03
- 157B-L38G8B-04
- 157B-L38G8B-91

3000K

LED COB AC 4W 345lm

- 157A-L0105B-01
- 157A-L0105B-02
- 157A-L0105B-03
- 157A-L0105B-04
- 157A-L0105B-91

2x LED COB AC 4W 345lm

- 157B-L01G8B-01
- 157B-L01G8B-02
- 157B-L01G8B-03
- 157B-L01G8B-04
- 157B-L01G8B-91

4000K

LED COB AC 4W 355lm

- 157A-L0205B-01
- 157A-L0205B-02
- 157A-L0205B-03
- 157A-L0205B-04
- 157A-L0205B-91

2x LED COB AC 4W 355lm

- 157B-L02G8B-01
- 157B-L02G8B-02
- 157B-L02G8B-03
- 157B-L02G8B-04
- 157B-L02G8B-91





Acabado blanco, negro, gris, antracita o marrón cobrizo
White, black, grey, anthracite or copper brown finish

Lamps P_860

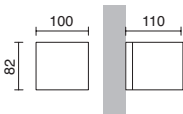

G9 Hal. 40W max.

- 157A-H20XIA-01
- 157A-H20XIA-02
- 157A-H20XIA-03
- 157A-H20XIA-04
- 157A-H20XIA-91



G9 Hal. 40W max.

- 157B-H20XIA-01
- 157B-H20XIA-02
- 157B-H20XIA-03
- 157B-H20XIA-04
- 157B-H20XIA-91



ISORA

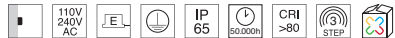

Acabado blanco, negro, gris, antracita o marrón cobrizo – White, black, grey, anthracite or copper brown finish



2700K

LED SMD 6W 950lm

- 157C-L3006B-01
- 157C-L3006B-02
- 157C-L3006B-03
- 157C-L3006B-04
- 157C-L3006B-91

- 157C-L30RDB-01
- 157C-L30RDB-02
- 157C-L30RDB-03
- 157C-L30RDB-04
- 157C-L30RDB-91

3000K

LED SMD 8,3W 1500lm

- 157C-L0109B-01
- 157C-L0109B-02
- 157C-L0109B-03
- 157C-L0109B-04
- 157C-L0109B-91

- 157C-L01RDB-01
- 157C-L01RDB-02
- 157C-L01RDB-03
- 157C-L01RDB-04
- 157C-L01RDB-91

4000K

LED COB AC 8,3W 1595lm

- 157C-L0209B-01
- 157C-L0209B-02
- 157C-L0209B-03
- 157C-L0209B-04
- 157C-L0209B-91

- 157C-L02RDB-01
- 157C-L02RDB-02
- 157C-L02RDB-03
- 157C-L02RDB-04
- 157C-L02RDB-91



2700K

2x LED SMD 6W 950lm

- 157D-L30G6B-01
- 157D-L30G6B-02
- 157D-L30G6B-03
- 157D-L30G6B-04
- 157D-L30G6B-91

- 157D-L30RDB-01
- 157D-L30RDB-02
- 157D-L30RDB-03
- 157D-L30RDB-04
- 157D-L30RDB-91

3000K

2x LED SMD 8,3W 1500lm

- 157D-L01G9B-01
- 157D-L01G9B-02
- 157D-L01G9B-03
- 157D-L01G9B-04
- 157D-L01G9B-91

- 157D-L01RDB-01
- 157D-L01RDB-02
- 157D-L01RDB-03
- 157D-L01RDB-04
- 157D-L01RDB-91

4000K

2x LED COB AC 8,3W 1595lm

- 157D-L02G9B-01
- 157D-L02G9B-02
- 157D-L02G9B-03
- 157D-L02G9B-04
- 157D-L02G9B-91

- 157D-L02RDB-01
- 157D-L02RDB-02
- 157D-L02RDB-03
- 157D-L02RDB-04
- 157D-L02RDB-91



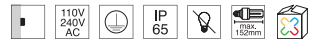
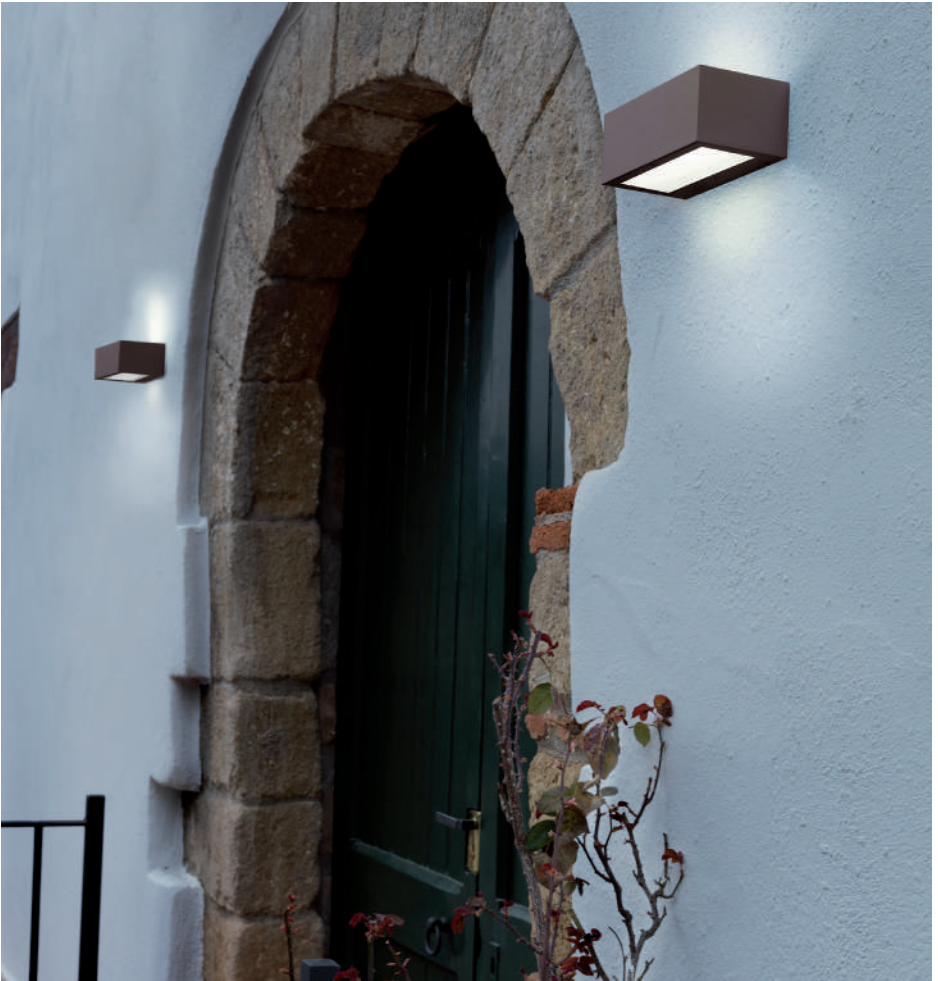

Acabado blanco, negro, gris, antracita o marrón cobrizo
White, black, grey, anthracite or copper brown finish

Lamps P_859

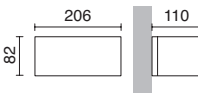

E27 (Ø54mm) 20W max.

- 157C-G05XIA-01
- 157C-G05XIA-02
- 157C-G05XIA-03
- 157C-G05XIA-04
- 157C-G05XIA-91



E27 (Ø54mm) 20W max.

- 157D-G05XIA-01
- 157D-G05XIA-02
- 157D-G05XIA-03
- 157D-G05XIA-04
- 157D-G05XIA-91



BUIT



Acabado antracita o marrón óxido – Anthracite or oxide brown finish

Consultar opciones de regulación
Consult regulation options

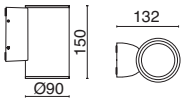

2700K	3000K	4000K		
LED COB 8W 770lm	LED COB 8W 800lm	LED COB 8W 830lm		
1084A-L3008A10-04	1084A-L3108A10-04	1084A-L3308A10-04		
1084A-L3008A10-90	1084A-L3108A10-90	1084A-L3308A10-90		
1084A-L3008A20-04	1084A-L3108A20-04	1084A-L3308A20-04		
1084A-L3008A20-90	1084A-L3108A20-90	1084A-L3308A20-90		
1084A-L3008A30-04	1084A-L3108A30-04	1084A-L3308A30-04		
1084A-L3008A30-90	1084A-L3108A30-90	1084A-L3308A30-90		

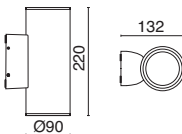

2700K	3000K	4000K	
LED COB 2x 6W 2x 610ml	LED COB 2x 6W 2x 660ml	LED COB 2x 6W 2x 690ml	
1084B-L3012A10-04	1084B-L3112A10-04	1084B-L3312A10-04	
1084B-L3012A10-90	1084B-L3112A10-90	1084B-L3312A10-90	
1084B-L3012A20-04	1084B-L3112A20-04	1084B-L3312A20-04	
1084B-L3012A20-90	1084B-L3112A20-90	1084B-L3312A20-90	
1084B-L3012A30-04	1084B-L3112A30-04	1084B-L3312A30-04	
1084B-L3012A30-90	1084B-L3112A30-90	1084B-L3312A30-90	



CUS

BUIT



Acabado antracita o marrón óxido – Anthracite or oxide brown finish

Consultar opciones de regulación
Consult regulation options

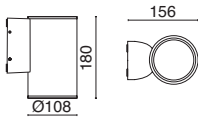

2700K	3000K	4000K	
LED COB 12W 1200lm	LED COB 12W 1260lm	LED COB 12W 1310lm	
1084C-L3012A10-04	1084C-L3112A10-04	1084C-L3312A10-04	
1084C-L3012A10-90	1084C-L3112A10-90	1084C-L3312A10-90	
1084C-L3012A20-04	1084C-L3112A20-04	1084C-L3312A20-04	
1084C-L3012A20-90	1084C-L3112A20-90	1084C-L3312A20-90	
1084C-L3012A30-04	1084C-L3112A30-04	1084C-L3312A30-90	
1084C-L3012A30-90	1084C-L3112A30-90	1084C-L3312A30-90	

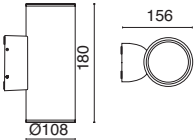

2700K	3000K	4000K	
LED COB 2x12W 2x 1200lm	LED COB 2x12W 2x 1260lm	LED COB 2x12W 2x 1310lm	
1084D-L3026A10-04	1084D-L3126A10-04	1084D-L3326A10-04	
1084D-L3026A10-90	1084D-L3126A10-90	1084D-L3326A10-90	
1084D-L3026A20-04	1084D-L3126A20-04	1084D-L3326A20-04	
1084D-L3026A20-90	1084D-L3126A20-90	1084D-L3326A20-90	
1084D-L3026A30-04	1084D-L3126A30-04	1084D-L3326A30-04	
1084D-L3026A30-90	1084D-L3126A30-90	1084D-L3326A30-90	



TASCA



Acabado antracita – Anthracite finish

Drivers P_862

Opciones de acabado a consultar – Finish options available for consultation

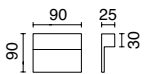

LED SMD 2W 280lm **2700K**

■ 1078A-L3002FC0-04

LED SMD 2W 280lm **3000K**

■ 1078A-L3102FC0-04

LED SMD 2W 280lm **4000K**

■ 1078A-L3302FC0-04

Compatible – 502E Electrical box

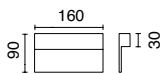

LED SMD 4W 560lm **2700K**

■ 1078B-L3004FC0-04

LED SMD 4W 560lm **3000K**

■ 1078B-L3104FC0-04

LED SMD 4W 560lm **4000K**

■ 1078B-L3304FC0-04

Compatible – 503E Electrical box

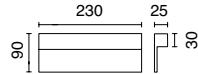

LED SMD 6W 840lm **2700K**

■ 1078C-L3006FC0-04

LED SMD 6W 840lm **3000K**

■ 1078C-L3106FC0-04

LED SMD 6W 840lm **4000K**

■ 1078C-L3306FC0-04

Compatible – 504E Electrical box



Alimentador – Power supply

12W

B02D-X3312F-00

220V 240V AC	24V DC	IP 65
IN	OUT	



RIMA

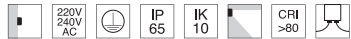

Acabado antracita – Anthracite finish

Consultar otras opciones de acabado
Consult other finishing options

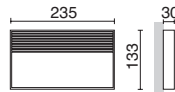
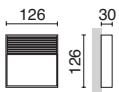

LED SMD AC 5W 540lm **3000K**

■ 923B-L3105B-04

LED SMD AC 13W 1410lm **3000K**

■ 923A-L3113B-04

LED SMD AC 5W 580lm **4000K**

■ 923B-L3305B-04

LED SMD AC 13W 1510lm **4000K**

■ 923A-L3313B-04

RIMA



Acabado antracita – Anthracite finish



Consultar otras opciones de acabado
Consult other finishing options

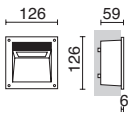

LED SMD AC 4W 500lm **3000K**

■ 261C-L0105B-04

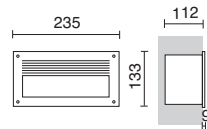

LED SMD AC 13W 1710lm **3000K**

■ 261A-L0109B-04

LED SMD AC 4W 510lm **4000K**

■ 261C-L0205B-04

LED SMD AC 13W 1790lm **4000K**

■ 261A-L0209B-04

SLIM



Acabado gris o antracita – Grey or anthracite finish

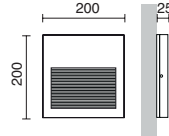
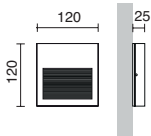

LED SMD 3W 367lm **3000K**

- 580A-L0104B-03
- 580A-L0104B-04



LED SMD 9W 1100lm **3000K**

- 580B-L0110B-03
- 580B-L0110B-04



LED SMD 3W 389lm **4000K**

- 580A-L0204B-03
- 580A-L0204B-04



LED SMD 9W 1165lm **4000K**

- 580B-L0210B-03
- 580B-L0210B-04



SLIM



Acabado gris o antracita – Grey or anthracite finish

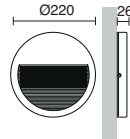
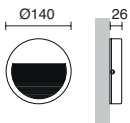

LED SMD 4W 544lm **3000K**

- 580C-L0104B-03
- 580C-L0104B-04



LED SMD 9W 1100lm **3000K**

- 580D-L0110B-03
- 580D-L0110B-04



LED SMD 4W 576lm **4000K**

- 580C-L0204B-03
- 580C-L0204B-04



LED SMD 9W 1165lm **4000K**

- 580D-L0210B-03
- 580D-L0210B-04



SLIM



Acabado gris o antracita – Grey or anthracite finish

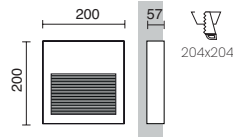
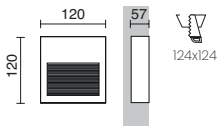

LED SMD 3W 367lm **3000K**

- 289B-L0104B-03
- 289B-L0104B-04



LED SMD 9W 1100lm **3000K**

- 289C-L0110B-03
- 289C-L0110B-04



LED SMD 3W 389lm **4000K**

- 289B-L0204B-03
- 289B-L0204B-04



LED SMD 9W 1165lm **4000K**

- 289C-L0210B-03
- 289C-L0210B-04



SLIM



Acabado gris o antracita – Grey or anthracite finish

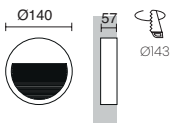

LED SMD 4W 544lm **3000K**

- 289D-L0104B-03
- 289D-L0104B-04

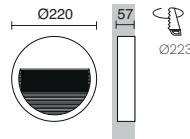

LED SMD 9W 1100lm **3000K**

- 289E-L0110B-03
- 289E-L0110B-04



LED SMD 4W 576lm **4000K**

- 289D-L0204B-03
- 289D-L0204B-04



LED SMD 9W 1165lm **4000K**

- 289E-L0210B-03
- 289E-L0210B-04



DAIN



Acabado blanco, negro, gris o marrón óxido – White, black, grey or oxide brown finish

Conector IP67 incluido
IP67 connector included

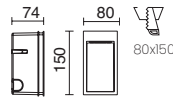
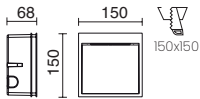

Disponibile en 91°
Available in 91°

LED SMD 9W 1000lm 3000K

- 929A-L3109B-01
- 929A-L3109B-02
- 929A-L3109B-03
- 929A-L3109B-90

LED SMD 4,5W 500lm 3000K

- 929B-L3105B-01
- 929B-L3105B-02
- 929B-L3105B-03
- 929B-L3105B-90

Reflector decorativo opcional – Optional decorative reflector

- A13A-929-01
- A13A-929-02
- A13A-929-03
- A13A-929-90

- A13B-929-01
- A13B-929-02
- A13B-929-03
- A13B-929-47
- A13B-929-90





DAIRA



Acabado blanco o antracita – White or anthracite finish

Lamps P_859

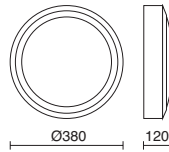
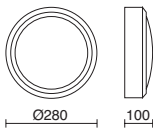

E27 Led/Hal/Fluo 42W max.

- 575B-G05XIA-01
- 575B-G05XIA-04

2x E27 Led/Hal/Fluo 42W max.

- 575A-G05XIA-01
- 575A-G05XIA-04



LED SMD AC 17,5W 1550lm 3000K

- 575B-L0118B-01
- 575B-L0118B-04

LED SMD AC 17W 1500lm 3000K

- 575A-L0129R-01
- 575A-L0129R-04



 EMERGENCY (3h max.)
LED 3W 250lm 4000K



Acabado blanco o antracita – White or anthracite finish

Lamps P_859

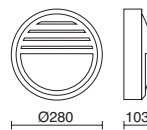
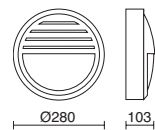

E27 Led/Hal/Fluo 42W max.

- 575C-G05XIA-01
- 575C-G05XIA-04



LED SMD AC 17,5W 1550lm 3000K

- 575C-L0118B-01
- 575C-L0118B-04



PLAFF



Acabado blanco o negro – White or black finish

Lamps P_859

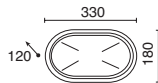
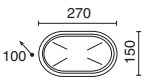

E27 Led/Hal/Fluo 42W max.

- 240B-G05XIA-01
- 240B-G05XIA-02

E27 Led/Hal/Fluo 42W max.

- 240C-G05XIA-01
- 240C-G05XIA-02

E27 Led/Hal/Fluo 42W max.

- 240E-G05XIA-01
- 240E-G05XIA-02

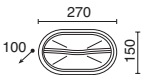

E27 Led/Hal/Fluo 42W max.

- 240A-G05XIA-01
- 240A-G05XIA-02

E27 Led/Hal/Fluo 42W max.

- 240D-G05XIA-01
- 240D-G05XIA-02



RUA

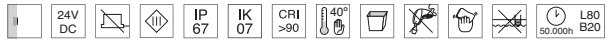

Acabado inox – Stainless steel finish

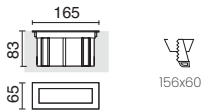

LED SMD 4W 505lm **2700K**

■ 1088A-L3004F90-30

LED SMD 4W 520lm **3000K**

■ 1088A-L3104F90-30

LED SMD 4W 555lm **4000K**

■ 1088A-L3304F90-30

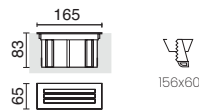

LED SMD 4W 505lm **2700K**

■ 1088B-L3004F90-30

LED SMD 4W 520lm **3000K**

■ 1088B-L3104F90-30

LED SMD 4W 555lm **4000K**

■ 1088B-L3304F90-30

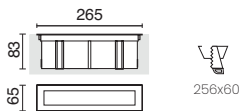

LED SMD 6W 685lm **2700K**

■ 1088C-L3006F90-30

LED SMD 6W 720lm **3000K**

■ 1088C-L3106F90-30

LED SMD 6W 790lm **4000K**

■ 1088C-L3306F90-30

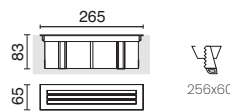

LED SMD 6W 685lm **2700K**

■ 1088D-L3006F90-30

LED SMD 6W 720lm **3000K**

■ 1088D-L3106F90-30

LED SMD 6W 790lm **4000K**

■ 1088D-L3306F90-30



Alimentador – Power supply

60 W (1088A- 1088B- max.13 unit.) (1088C- 1088D- max.8 unit.)

B02R-X3360F-00





TRAU



ALU



Acabado antracita – Anthracite finish
 Opciones de acabado a consultar
 Finish options available for consultation

Incorpora válvula depresora para evitar la entrada de humedad
 It incorporates a depressor valve to prevent the entry of moisture



LED SMD 4W 570lm **2700K**



■ 1087A-L3004AA0-04

LED SMD 4W 570lm **2700K**



■ 1087B-L3004AA0-04

LED SMD 4W 600lm **3000K**

■ 1087A-L3104AA0-04

LED SMD 4W 600lm **3000K**

■ 1087B-L3104AA0-04

LED SMD 4W 625lm **4000K**

■ 1087A-L3304AA0-04

LED SMD 4W 625lm **4000K**

■ 1087B-L3304AA0-04



COC



Acabado blanco o negro – White or black finish

Lamps P_859

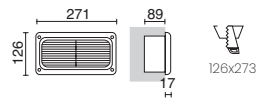
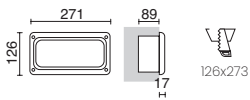

E27 Led/Hal/Fluo 42W max.

- 063A-G05XIA-01
- 063A-G05XIA-02

E27 Led/Hal/Fluo 42W max.

- 063B-G05XIA-01
- 063B-G05XIA-02



Downlights_

STONE

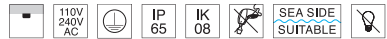

Conector IP67 incluido
IP67 connector included

Lamps P_860

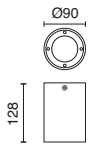

No utilizar atornillador mecánico
Never use mechanical screwdriver



GU10 12W max.

- 965D-G2IXIA-NB
- 965D-G2IXIA-NN
- 965D-G2IXIA-NR
- 965D-G2IXIA-NW

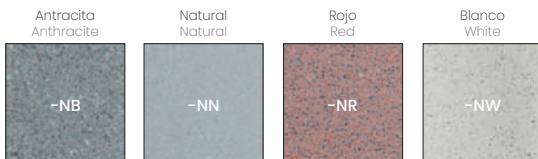



ATIC

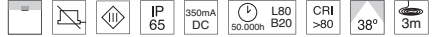

Acabado blanco – White finish

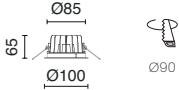



LED COB 9W 1940lm **3000K**

LED COB 9W 2000lm **4000K**

□ 1040A-L3109H30-01

□ 1040A-L3309H30-01

 **Alimentador – Power supply**
 max. 17W 350mA DC 220V
240V
AC IP
20
 B02A-X3316HN-01

 **Alimentador – Power supply**
 max. 26W 350mA DC 110V
240V
AC IP
67
 ON DIP
 1 2 3 4
 B02P-X3326HI-01

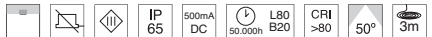

Acabado blanco – White finish

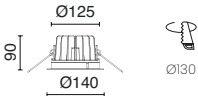



LED COB 18W 2845lm **3000K**

LED COB 18W 2960lm **4000K**

□ 1040B-L3118I50-01

□ 1040B-L3318I50-01

 **Alimentador – Power supply**
 max. 17W 350mA DC 220V
240V
AC IP
20
 B02A-X3316HN-01

 **Alimentador – Power supply**
 max. 26W 350mA DC 110V
240V
AC IP
67
 ON DIP
 1 2 3 4
 B02P-X3326HI-01

ATIC

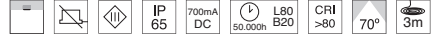

Acabado blanco – White finish

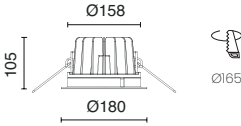

LED COB 24W 4115lm **3000K**

LED COB 24W 4266lm **4000K**

□ I040C-L3124J70-01

□ I040C-L3324J70-01

Alimentador – Power supply
max. 30W 700mA DC

B02N-X3330J-01

220V
240V
AC

IP 20

Alimentador – Power supply
max. 40W 700mA DC

B02P-X3340JM-01

ON 1 2 3 4

DIP 3 4

110V
240V
AC

IP 67

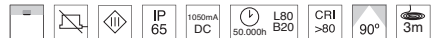

Acabado blanco – White finish

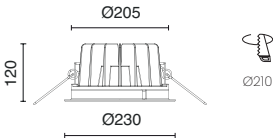

LED COB 37W 5925lm **3000K**

LED COB 37W 6155lm **4000K**

□ I040D-L3137M90-01

□ I040D-L3337M90-01

Alimentador – Power supply
max. 30W 700mA DC

B02N-X3330J-01

220V
240V
AC

IP 20

Alimentador – Power supply
max. 40W 700mA DC

B02P-X3340JM-01

ON 1 2 3 4

DIP 3 4

110V
240V
AC

IP 67

NABUCO



Acabado inox – Stainless steel finish

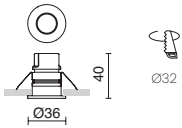

LED COB **3W** 350lm 3000K

980A-L0103H-30

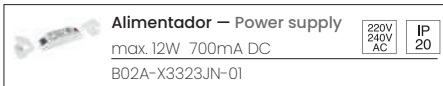

980A-

Disponible en 30°, 45° o asimétrico
Available in 45° or asymmetric

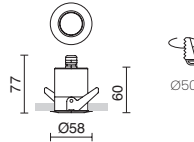

LED COB **4,5W** 600lm 3000K

980B-L0104H-30

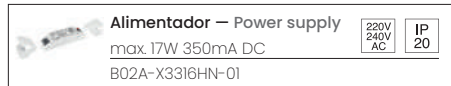

LED COB **6,5W** 785lm 3000K

980B-L0106H-30

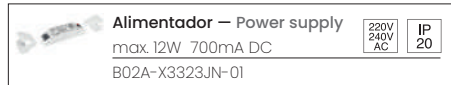

980B-

Disponible en 52°
Available in 52°

P_758



Regulable con dispositivos de control específicos (alimentadores P_862)
Adjustable with specific control devices (power supplies P_862)



¿Cómo instalar un empotrable en el suelo?



How to install a recessed floor?



Uplights_

CROSCAT



Acabado inox – Stainless steel finish

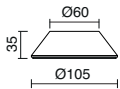

LED SMD 5W 710lm **3000K**

LED SMD 5W 750lm **4000K**

1082A-L3105F10-30

1082A-L3305F10-30



1082A-L3105F40-30

1082A-L3305F40-30



	Alimentador – Power supply		
	12W		
	B02D-X3312F-00		
220V 240V AC	24V DC	IP 65	
IN	OUT		



NABUCO

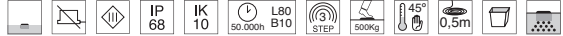

Acabado inox – Stainless steel finish



Connectors P_861

Regulable con dispositivos de control específicos (alimentadores P_862)
Adjustable with specific control devices (power supplies P_862)

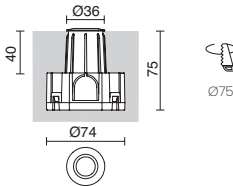

LED COB 3W 350lm 3000K

980H-L0103H-30



	Alimentador – Power supply max.12W 700mA DC B02A-X3323JN-01	<table border="1"><tr><td>220V 240V AC</td><td>IP 20</td></tr></table>	220V 240V AC	IP 20
220V 240V AC	IP 20			

980H+

Disponible en 45° o asimétrico
Available in 45° or asymmetric

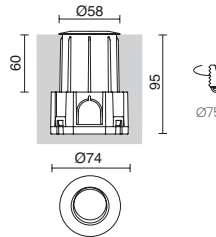

LED COB 4,5W 600lm 3000K

980I-L0104H-30



	Alimentador – Power supply max.17W 350mA DC B02A-X3316HN-01	<table border="1"><tr><td>220V 240V AC</td><td>IP 20</td></tr></table>	220V 240V AC	IP 20
220V 240V AC	IP 20			

LED COB 6,5W 785lm 3000K

980I-L0106H-30



	Alimentador – Power supply max.12W 700mA DC B02A-X3323JN-01	<table border="1"><tr><td>220V 240V AC</td><td>IP 20</td></tr></table>	220V 240V AC	IP 20
220V 240V AC	IP 20			

980I-

Disponible en 52°
Available in 52°

P_752



Evite siempre colocar las luminarias en vaguadas o depresiones del terreno. Es indispensable realizar un drenaje.
Always avoid placing the lights in valleys or depressions of the ground. It is essential to carry out an efficient drainage.



ESTAMBUL



Acabado inox o latón – Stainless steel or brass finish

Tornillos antihurto, posición de portalámparas variable
Anti-theft screws, adjustable lampholder position

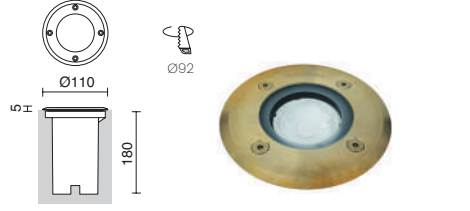
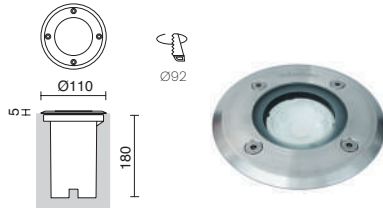

Connectors P_861
Lamps P_860

GU10 Led/Hal 35W max.

■ 410A-G21XIA-30



GU10 Led/Hal 35W max.

■ 410A-G21XIA-34



FOCUS



Acabado negro – Black finish



GU10 LED 3000K 5W (36°)

■ 113A-L2105A-02



Evite siempre colocar las luminarias en vauadas o depresiones del terreno. Es indispensable realizar un drenaje.
Always avoid placing the lights in valleys or depressions of the ground. It is essential to carry out an efficient drainage.





MALVA



Acabado inox – Stainless steel finish

Connectors P_861

Marco cuadrado disponible
Square frame available

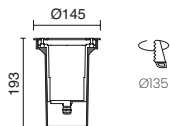

Sistema AcquaStop en el interior del prensaestopas.
AcquaStop system inside the cable gland.

LED COB 6W 817lm **2700K**

LED COB 6W 860lm **3000K**

LED COB 6W 890lm **4000K**

1023A-L3007B10-30

1023A-L3107B10-30

1023A-L3307B10-30

10°

1023A-L3007B20-30

1023A-L3107B20-30

1023A-L3307B20-30

26°

1023A-L3007B50-30

1023A-L3107B50-30

1023A-L3307B50-30

56°



Evite siempre colocar las luminarias en vaguadas o depresiones del terreno. Es indispensable realizar un drenaje.
Always avoid placing the lights in valleys or depressions of the ground. It is essential to carry out an efficient drainage.

MALVA

RGB+W (6500K)



Acabado inox – Stainless steel finish

Drivers P_862

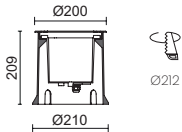

 Connectors P_861



Marco cuadrado disponible 
Square frame available

Sistema AcquaStop en el interior del prensaestopas.
AcquaStop system inside the cable gland.

LED SMD 12W 1650lm

	1023F-L1412FX-30	15°
	1023F-L1412F3X-30	35°
	1023F-L1412F6X-30	60°

 **Alimentador – Power supply**
100W (max. 7 unit.)
B02R-X33AIF-01

90V 264V AC	24V DC	IP 67
IN	OUT	

 **Resistencia de terminación DMX (120ohm)**
DMX terminating resistor (120ohm)

 RES-1089A-38

 Kit Controlador y mando a distancia para RGB/RGBW
Controller and remote control kit for RGB/RGBW

CONT.R9+XC

Controller
Control: RF 2.4Ghz
Exit sign: DMX512
Input Voltage: 5-24Vdc
10 static colors
32 dynamics modes

Telecomando
Control: 1 zone (30m)
power supply: 1xCR2032 non inclue (3Vdc)
Exit sign: RF 2.4Ghz

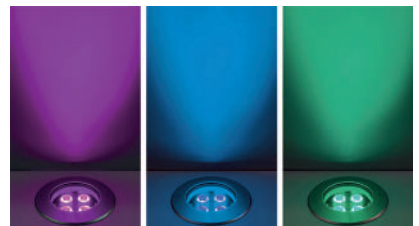

Evite siempre colocar las luminarias en vaguadas o depresiones del terreno. Es indispensable realizar un drenaje.
Always avoid placing the lights in valleys or depressions of the ground. It is essential to carry out an efficient drainage.

MALVA

TILT



Acabado inox – Stainless steel finish

Connectors P_861

Marco cuadrado disponible Square frame available

Sistema AcquaStop en el interior del prensaestopas.
AcquaStop system inside the cable gland.

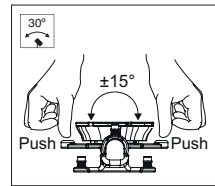
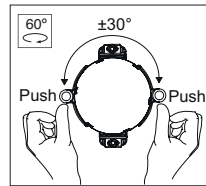
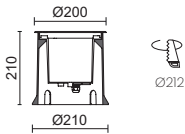

LED COB 16W 2400lm 2700K	LED COB 16W 2400lm 3000K	LED COB 16W 2550lm 4000K	
1023G-L3016B10-30	1023G-L3116B10-30	1023G-L3316B10-30	
1023G-L3016B30-30	1023G-L3116B30-30	1023G-L3316B30-30	
1023G-L3016B50-30	1023G-L3116B50-30	1023G-L3316B50-30	
1023G-L3016BP0-30	1023G-L3116BP0-30	1023G-L3316BP0-30	

LED COB 16W 2400lm 2700K	LED COB 16W 2400lm 3000K	LED COB 16W 2550lm 4000K	
1023G-L3016B1D-30	1023G-L3116B1D-30	1023G-L3316B1D-30	
1023G-L3016B3D-30	1023G-L3116B3D-30	1023G-L3316B3D-30	
1023G-L3016B5D-30	1023G-L3116B5D-30	1023G-L3316B5D-30	
1023G-L3016BPD-30	1023G-L3116BPD-30	1023G-L3316BPD-30	



Evite siempre colocar las luminarias en vaguadas o depresiones del terreno. Es indispensable realizar un drenaje.
Always avoid placing the lights in valleys or depressions of the ground. It is essential to carry out an efficient drainage.



MALVA



Acabado inox – Stainless steel finish

Connectors P_86I

Marco cuadrado disponible
Square frame available

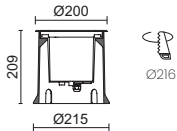

Sistema AcquaStop en el interior del prensaestopas.
AcquaStop system inside the cable gland.

LED COB 18W 2565lm 2700K	LED COB 18W 2700lm 3000K	LED COB 18W 2850lm 4000K	
1023B-L3018B10-30	1023B-L3118B10-30	1023B-L3318B10-30	15°
1023B-L3018B20-30	1023B-L3118B20-30	1023B-L3318B20-30	25°
1023B-L3018B30-30	1023B-L3118B30-30	1023B-L3318B30-30	36°

LED COB 18W 2565lm 2700K	LED COB 18W 2700lm 3000K	LED COB 18W 2850lm 4000K	
1023B-L3018B1D-30	1023B-L3118B1D-30	1023B-L3318B1D-30	15°
1023B-L3018B2D-30	1023B-L3118B2D-30	1023B-L3318B2D-30	25°
1023B-L3018B3D-30	1023B-L3118B3D-30	1023B-L3318B3D-30	36°



Evite siempre colocar las luminarias en vaguadas o depresiones del terreno. Es indispensable realizar un drenaje.
Always avoid placing the lights in valleys or depressions of the ground. It is essential to carry out an efficient drainage.

MALVA



Acabado inox – Stainless steel finish

Connectors P_861

Marco cuadrado disponible
Square frame available

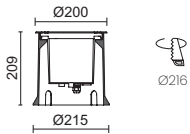

Sistema AcquaStop en el interior del prensaestopas.
AcquaStop system inside the cable gland.

LED COB 18W 2565lm **2700K** LED COB 18W 2700lm **3000K** LED COB 18W 2850lm **4000K**

1023B-L3018BZ0-30 1023B-L3118BZ0-30 1023B-L3318BZ0-30

LED COB 18W 2565lm **2700K** LED COB 18W 2700lm **3000K** LED COB 18W 2850lm **4000K**

1023B-L3018BZD-30 1023B-L3118BZD-30 1023B-L3318BZD-30



Évite siempre colocar las luminarias en vaguadas o depresiones del terreno. Es indispensable realizar un drenaje.
Always avoid placing the lights in valleys or depressions of the ground. It is essential to carry out an efficient drainage.

MALVA



Acabado inox – Stainless steel finish

Connectors P_86I

Consultar otras opciones de regulación
Consult other regulation options

Marco cuadrado disponible
Square frame available

Sistema AcquaStop en el interior del prensaestopas.
AcquaStop system inside the cable gland.

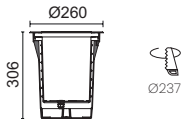

LED COB 32W 4605lm 2700K	LED COB 32W 4850lm 3000K	LED COB 32W 5100lm 4000K	
1023D-L3025B10-30	1023D-L3125B10-30	1023D-L3325B10-30	14°
1023D-L3025B30-30	1023D-L3125B30-30	1023D-L3325B30-30	32°
1023D-L3025B40-30	1023D-L3125B40-30	1023D-L3325B40-30	44°

LED COB 32W 4605lm 2700K	LED COB 32W 4850lm 3000K	LED COB 32W 5100lm 4000K	
1023D-L3025B1D-30	1023D-L3125B1D-30	1023D-L3325B1D-30	14°
1023D-L3025B3D-30	1023D-L3125B3D-30	1023D-L3325B3D-30	32°
1023D-L3025B4D-30	1023D-L3125B4D-30	1023D-L3325B4D-30	44°



Evite siempre colocar las luminarias en vaguadas o depresiones del terreno. Es indispensable realizar un drenaje.
Always avoid placing the lights in valleys or depressions of the ground. It is essential to carry out an efficient drainage.

MALVA



Acabado inox – Stainless steel finish

Connectors P_86i

Consultar otras opciones de regulación
Consult other regulation options

Marco cuadrado disponible
Square frame available

Sistema AcquaStop en el interior del prensaestopas.
AcquaStop system inside the cable gland.

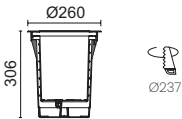

LED COB 26W 3365lm 2700K	LED COB 26W 3540lm 3000K	LED COB 26W 3670lm 4000K
1023E-L3025B30-30	1023E-L3125B30-30	1023E-L3325B30-30
LED COB 26W 3365lm 2700K	LED COB 26W 3540lm 3000K	LED COB 26W 3670lm 4000K
1023E-L3025B3D-30	1023E-L3125B3D-30	1023E-L3325B3D-30



Evite siempre colocar las luminarias en vaguadas o depresiones del terreno. Es indispensable realizar un drenaje.
Always avoid placing the lights in valleys or depressions of the ground. It is essential to carry out an efficient drainage.

NAT-LED



Acabado inox – Stainless steel finish
Luz blanco o azul – White or blue light

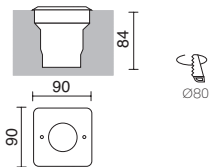

LED SMD 1,5W 180lm **3500K**

■ ○ 213A-LI0102F-30

LED SMD 1,5W **Azul – Blue**

■ ● 213A-LI002F-30

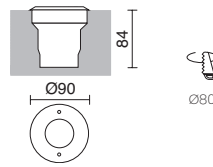

LED SMD 1,5W 180lm **3500K**

■ ○ 213B-LI0102F-30

LED SMD 1,5W **Azul – Blue**

■ ● 213B-LI002F-30

Alimentador – Power supply
15W (max. 8 unit.)
B02A-X33X2F-01

220V 240V AC	24V DC	IP 20
IN	OUT	

Alimentador – Power supply
12W (max. 6 unit.)
B02Q-X3312F-01

80V 225V AC	24V DC	IP 30
IN	OUT	

NODY



665B-
665C-



665E-
665F-

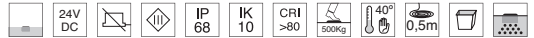

Acabado inox cepillado – Brushed stainless steel finish

Connectors P_861

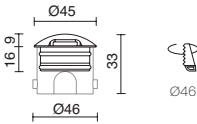

LED COB 1,5W 170lm **3000K**

LED COB 1,5W 180lm **4000K**

665B-L0102F-43

665B-L0202F-43



665E-L0102F-43

665E-L0202F-43

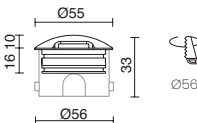

LED COB 2W 320lm **3000K**

LED COB 2W 340lm **4000K**

665C-L0102F-43

665C-L0202F-43



665F-L0102F-43

665F-L0202F-43



Alimentador – Power supply

max. 12W (0x5)

B02Q-X3312F-01

max. 35W (0x14)

B02Q-X3335F-01

110V 240V AC	24V DC	50Hz 60Hz	IP 42
IN		OUT	



Evite siempre colocar las luminarias en vaguadas o depresiones del terreno. Es indispensable realizar un drenaje. Always avoid placing the lights in valleys or depressions of the ground. It is essential to carry out an efficient drainage.

GARDA



1070A-



1070B-



1070C-



Acabado antracita – Anthracite finish
 Opciones de acabado a consultar
 Finish options available for consultation

Drivers P_862

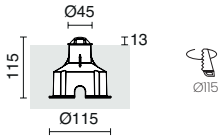

LED SMD 2W 170lm **2700K**

■ 1070A-L3002FX0-04

LED SMD 2W 170lm **3000K**

■ 1070A-L3102FX0-04

LED SMD 2W 190lm **4000K**

■ 1070A-L3302FX0-04



LED SMD 2W 170lm **2700K**

■ 1070B-L3002FX0-04

LED SMD 2W 170lm **3000K**

■ 1070B-L3102FX0-04

LED SMD 2W 190lm **4000K**

■ 1070B-L3302FX0-04



LED SMD 2W 170lm **2700K**

■ 1070C-L3002FX0-04

LED SMD 2W 170lm **3000K**

■ 1070C-L3102FX0-04

LED SMD 2W 190lm **4000K**

■ 1070C-L3302FX0-04



Alimentador – Power supply
 100W (max. 40 unit.)
 B02R-X33A1F-01

90V 264V AC	24V DC	IP 67
IN	OUT	

Sistema AcquaStop en el interior del prensaestopas.
 AcquaStop system inside the cable gland.



Evite siempre colocar las luminarias en vaguadas o depresiones del terreno. Es indispensable realizar un drenaje.
 Always avoid placing the lights in valleys or depressions of the ground. It is essential to carry out an efficient drainage.

GARDA



1070D-

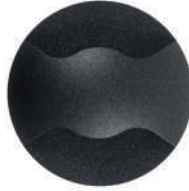

1070E-



1070F-



Acabado antracita – Anthracite finish
 Opciones de acabado a consultar
 Finish options available for consultation

Drivers P_862

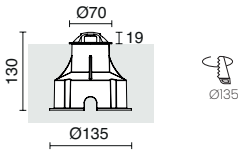

LED SMD 6W 690lm **2700K**

■ 1070D-L3006FX0-04



LED SMD 6W 690lm **2700K**

■ 1070E-L3006FX0-04



LED SMD 6W 690lm **2700K**

■ 1070F-L3006FX0-04

LED SMD 6W 690lm **3000K**

■ 1070D-L3106FX0-04

LED SMD 6W 690lm **3000K**

■ 1070E-L3106FX0-04

LED SMD 6W 690lm **3000K**

■ 1070F-L3106FX0-04

LED SMD 6W 750lm **4000K**

■ 1070D-L3306FX0-04

LED SMD 6W 750lm **4000K**

■ 1070E-L3306FX0-04

LED SMD 6W 750lm **4000K**

■ 1070F-L3306FX0-04



Alimentador – Power supply
 100W (max. 14 unit.)
 B02R-X33A1F-01

90V 264V AC	24V DC	IP 67
IN	OUT	

Sistema AcquaStop en el interior del prensaestopas.
 AcquaStop system inside the cable gland.



Evite siempre colocar las luminarias en vaguadas o depresiones del terreno. Es indispensable realizar un drenaje.
 Always avoid placing the lights in valleys or depressions of the ground. It is essential to carry out an efficient drainage.

SURI



302A-



302B-



302C-



Acabado antracita – Anthracite finish

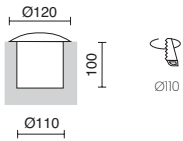

LED SMD AC 4W 500lm **3000K**

■ 302A-L0105B-04



LED SMD AC 4W 500lm **3000K**

■ 302B-L0105B-04



LED SMD AC 4W 500lm **3000K**

■ 302C-L0105B-04



LED SMD AC 4W 510lm **4000K**

■ 302A-L0205B-04



LED SMD AC 4W 510lm **4000K**

■ 302B-L0205B-04



LED SMD AC 4W 510lm **4000K**

■ 302C-L0205B-04



Evite siempre colocar las luminarias en vaguadas o depresiones del terreno. Es indispensable realizar un drenaje.
Always avoid placing the lights in valleys or depressions of the ground. It is essential to carry out an efficient drainage.

SURI BIG



303A-



303B-



303C-



Acabado antracita – Anthracite finish

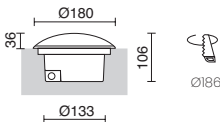

LED SMD 6W 800lm **3000K**

■ 303A-L0106A-04

LED SMD 6W 800lm **4000K**

■ 303A-L0206A-04



LED SMD 6W 800lm **3000K**

■ 303B-L0106A-04

LED SMD 6W 800lm **4000K**

■ 303B-L0206A-04



LED SMD 6W 800lm **3000K**

■ 303C-L0106A-04

LED SMD 6W 800lm **4000K**

■ 303C-L0206A-04



Evite siempre colocar las luminarias en vaguadas o depresiones del terreno. Es indispensable realizar un drenaje.
Always avoid placing the lights in valleys or depressions of the ground. It is essential to carry out an efficient drainage.

Wall Washer_

LANCE



Acabado antracita – Anthracite finish

Conector IP67 incluido
IP67 connector included

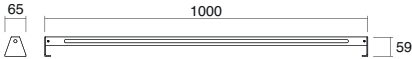

LED SMD AC 15W 1500lm **3000K**

■ 1024C-L3115BX0-04

LED SMD AC 15W 1620lm **4000K**

■ 1024C-L3315BX0-04



P_718

P_802



WALK



Video



Acabado gris – Grey finish



Connectors P_861

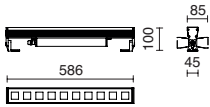

LED SMD 24W 3600lm **3000K**

LED SMD 24W 3780lm **4000K**

920A-L3122B-03

920A-L3322B-03



920B-L3122B-03

920B-L3322B-03

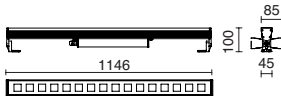

LED SMD 52W 7200lm **3000K**

LED SMD 52W 7560lm **4000K**

920C-L3147B-03

920C-L3347B-03



920D-L3147B-03

920D-L3347B-03



P_782



Sistema AcquaStop en el interior del prensaestopas – AcquaStop system inside the cable gland.

Consultar otras longitudes, ópticas y versiones regulables disponibles.

Consult other available lengths, optics, and adjustable versions.

WALK

RGB+W (6500K)



Video



ALU GLASS TRANS
24V DC
DMX
IP 67
IK 07
24°
180°
0,5m

Acabado gris – Grey finish

Connectors P_861

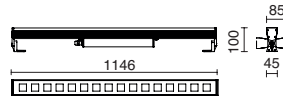
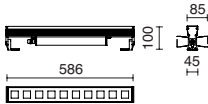

LED SMD **24W** 3300lm

920A-L1440F-03

LED SMD **48W** 6600lm

920C-L1480F-03

Kit Controlador y mando a distancia para RGB/RGBW
Controller and remote control kit for RGB/RGBW

CONT.R9+XC

Controller Control: RF 2.4Ghz Exit sign: DMX512 Input Voltage: 5-24Vdc 10 statics colors 32 dynamics modes	Telecomando Control: 1 zone (30m) power supply: IXCR2032 non include (3Vdc) Exit sign: RF 2.4Ghz
--	---

Resistencia de terminación DMX (120ohm)
DMX terminating resistor (120ohm)

RES-1089A-38

Led Driver 24V DC remotos a consultar – Remote Led Driver 24V DC under request.

Sistema AcquaStop en el interior del prensaestopas – AcquaStop system inside the cable gland.

Sistema control DMX integrado – Integrated DMX control system.

Led Driver 24V DC remotos a consultar – Remote Led Driver 24V DC under request.

Consultar otras longitudes, ópticas y versiones regulables disponibles.

Consult other available lengths, optics, and adjustable versions.



WALK



Video



920G-
920H-



920M- / 920N-
920O- / 920P-



Acabado inox – Stainless steel finish

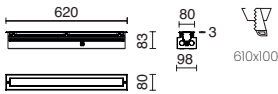

3000K

LED SMD 12W 1740lm

■ 920G-L3112B-30

4000K

LED SMD 12W 1840lm

■ 920G-L3312B-30



LED SMD 24W 3600lm

■ 920M-L3122B-30

LED SMD 24W 3780lm

■ 920M-L3322B-30



■ 920N-L3122B-30

■ 920N-L3322B-30

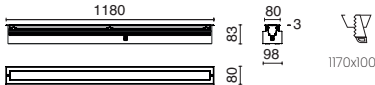

3000K

LED SMD 24W 3480lm

■ 920H-L3124B-30

4000K

LED SMD 24W 3680lm

■ 920H-L3324B-30



LED SMD 52W 7200lm

■ 920O-L3147B-30

LED SMD 52W 7560lm

■ 920O-L3347B-30



■ 920P-L3147B-30

■ 920P-L3347B-30



Evite siempre colocar las luminarias en vaguadas o depresiones del terreno. Es indispensable realizar un drenaje. Always avoid placing the lights in valleys or depressions of the ground. It is essential to carry out an efficient drainage.

Sistema AcquaStop en el interior del prensaestopas – AcquaStop system inside the cable gland.

Consultar otras longitudes, ópticas y versiones regulables disponibles
Consult other available lengths, optics, and adjustable versions

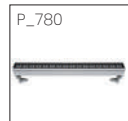

WALK

RGB+W (6500K)



Video



Acabado inox — Stainless steel finish

Connectors P_861

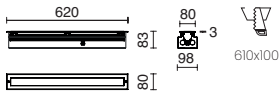

LED SMD **24W** 3300lm

920M-L1440F-30

LED SMD **48W** 6600lm

920C-L1480F-30



Kit Controlador y mando a distancia para RGB/RGBW
Controller and remote control kit for RGB/RGBW

CONT.R9+XC

Controller
Control: RF 2.4Ghz
Exit sign: DMX512
Input Voltage: 5-24Vdc
10 statics colors
32 dynamics modes

Telecomando
Control: 1 zone (30m)
power supply: IxCR2032
non include (3Vdc)
Exit sign: RF 2.4Ghz



Resistencia de terminación DMX (120ohm)
DMX terminating resistor (120ohm)

RES-1089A-38

Led Driver 24V DC remotos a consultar — Remote Led Driver 24V DC under request.



Evite siempre colocar las luminarias en vaguadas o depresiones del terreno. Es indispensable realizar un drenaje.
Always avoid placing the lights in valleys or depressions of the ground. It is essential to carry out an efficient drainage.

Sistema AcquaStop en el interior del prensaestopas — AcquaStop system inside the cable gland.

Consultar otras longitudes, ópticas y versiones regulables disponibles
Consult other available lengths, optics, and adjustable versions



Solar_

INTI

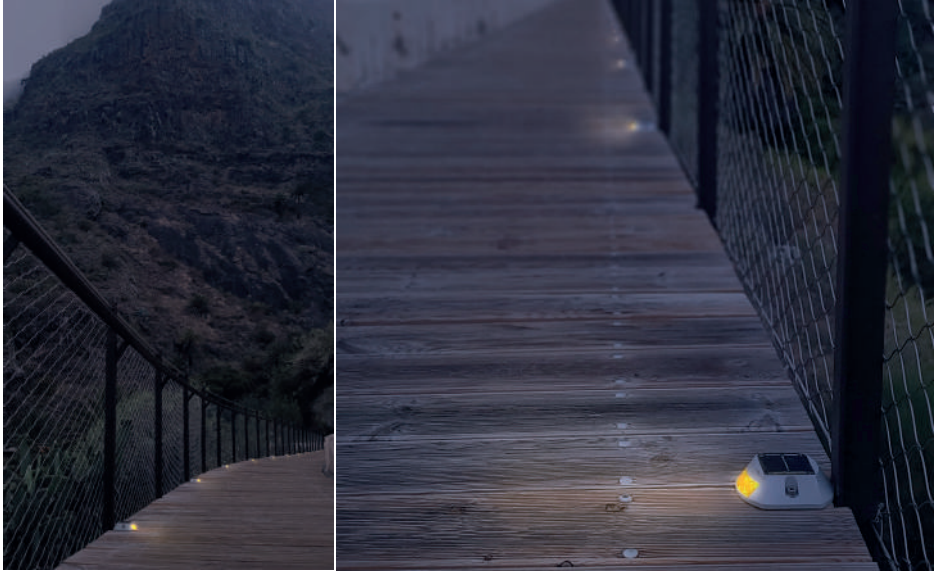

Acabado gris — Grey finish

Luz blanco o naranja — White or orange light

Consultar otros colores disponibles — Check other available colors

Nuevo acabado anticorrosión
New anti-corrosion finish

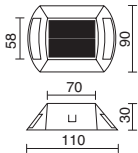

Pseudo-Condensador Pseudo-Capacitor
Vida útil — Life span >100.000 Ciclos — Cycles
100% Seguro — Safety -40°C / 75°C

Intermitente — Flashing

Fijo — Steady

- ☐ 152A-L02XIK-03S
- 152A-L07XIK-03S

- ☐ 152B-L02XIK-03S
- 152B-L07XIK-03S

3 LED

- ☐ 152C-L02XIK-03S
- 152C-L07XIK-03S

- ☐ 152D-L02XIK-03S
- 152D-L07XIK-03S

3+3 LED

Tiempo de carga: 3/8h. Duración carga completa: 16h. Nivel sensor: 150/350 lux.
Loading time: 3/8h. Full load duration: 16h. Sensor level: 150/350 lux

MITRA



Acabado gris — Grey finish
Luz blanco o naranja — White or orange light

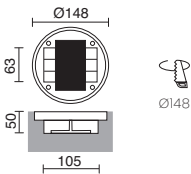

Pseudo-Condensador
Pseudo-Capacitor

Vida útil — Life span
>100.000 Ciclos — Cycles
100% Seguro — Safety
-40°C / 75°C

Intermitente — Flashing

- ☐ ○ 208A-L02XIK-03
- ☐ ● 208A-L07XIK-03

Fijo — Steady

- ☐ ○ 208B-L02XIK-03
- ☐ ● 208B-L07XIK-03



- ☐ ○ 208C-L02XIK-03
- ☐ ● 208C-L07XIK-03

- ☐ ○ 208D-L02XIK-03
- ☐ ● 208D-L07XIK-03



Tiempo de carga: 3/8h. Duración carga completa: 16h. Nivel sensor: 150/350 lux.
Loading time: 3/8h. Full load duration: 16h. Sensor level: 150/350 lux



Evite siempre colocar las luminarias en vaguadas o depresiones del terreno. Es indispensable realizar un drenaje.
Always avoid placing the lights in valleys or depressions of the ground. It is essential to carry out an efficient drainage.

Spotlights_

FUJI

RGB+W (3000K)



Acabado negro – Black finish

Incorpora válvula depresora para evitar la entrada de humedad
It incorporates a depressor valve to prevent the entry of moisture

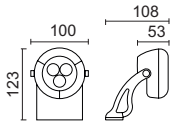

LED SMD DMX 6W RGBW

■ 1089A-L1406FIX-02	15°
■ 1089A-L1406FKX-02	15x30°
■ 1089A-L1406F2X-02	25°
■ 1089A-L1406F6X-02	60°

Piqueta Spike PVC

■ A05A-1089A-02

Aro fijación cincado
Zinc plated fastening ring

A06A-1089A-38

Resistencia de terminación DMX (120ohm)
DMX terminating resistor (120ohm)

■ RES-1089A-38

Kit Controlador y mando a distancia para RGB/RGBW
Controller and remote control kit for RGB/RGBW

CONT.R9+XC

<p>Controller Control: RF 2.4Ghz Exit sign: DMX512 Input Voltage: 5-24Vdc 10 statics colors 32 dynamics modes</p>	<p>Telecomando Control: I zone (30m) Power supply: ICR2032 non include (3Vdc) Exit sign: RF 2.4Ghz</p>
--	---



KALOS



Acabado antracita – Anthracite finish

Connectors P_861

Cable con dispositivo AcquaStop
Cable with AcquaStop device

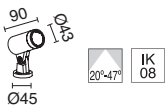

2700K
LED COB 5W 460lm
■ 1052A-L3806BV0-04

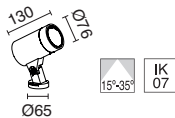

2700K
LED COB 10,5W 1140lm
■ 1052B-L3812BV0-04

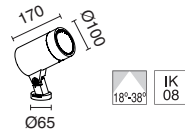

2700K
LED COB 24,5W 2580lm
■ 1052C-L3828BV0-04

3000K
LED COB 5W 485lm
■ 1052A-L3906BV0-04

3000K
LED COB 10,5W 1240lm
■ 1052B-L3912BV0-04

3000K
LED COB 24,5W 3035lm
■ 1052C-L3928BV0-04

4000K
LED COB 5W 505lm
■ 1052A-L4006BV0-04

4000K
LED COB 10,5W 1260lm
■ 1052B-L4012BV0-04

4000K
LED COB 24,5W 3160lm
■ 1052C-L4028BV0-04

For 1052A

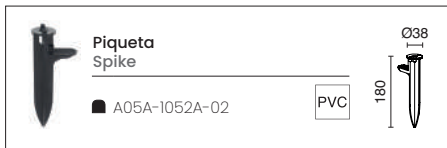

For 1052B-1052C

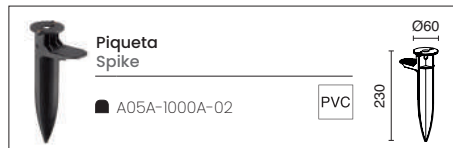



STONE

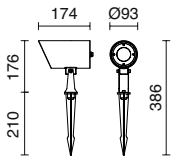

Conector IP67 incluido
IP67 connector included
Lamps P_860

No utilizar atornillador mecánico
Never use mechanical screwdriver



GU10 7W max.

- 965H-G2IX1A-NB
- 965H-G2IX1A-NN

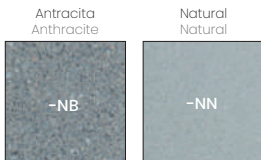



DISC



Acabado blanco o antracita – White or anthracite finish

Consultar opciones de regulación

Consult regulation options

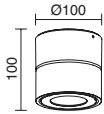

2700K

LED COB **9W** 1098lm

- 1000A-L3009B10-01
- 1000A-L3009B10-04

- 1000A-L3009B30-01
- 1000A-L3009B30-04

- 1000A-L3009B50-01
- 1000A-L3009B50-04

3000K

LED COB **9W** 1155lm

- 1000A-L3109B10-01
- 1000A-L3109B10-04

- 1000A-L3109B30-01
- 1000A-L3109B30-04

- 1000A-L3109B50-01
- 1000A-L3109B50-04

4000K

LED COB **9W** 1200lm

- 1000A-L3309B10-01
- 1000A-L3309B10-04

- 1000A-L3309B30-01
- 1000A-L3309B30-04

- 1000A-L3309B50-01
- 1000A-L3309B50-04



2700K

LED COB **13W** 1405lm

- 1000A-L3013B10-01
- 1000A-L3013B10-04

- 1000A-L3013B30-01
- 1000A-L3013B30-04

- 1000A-L3013B50-01
- 1000A-L3013B50-04

3000K

LED COB **13W** 1480lm

- 1000A-L3113B10-01
- 1000A-L3113B10-04

- 1000A-L3113B30-01
- 1000A-L3113B30-04

- 1000A-L3113B50-01
- 1000A-L3113B50-04

4000K

LED COB **13W** 1540lm

- 1000A-L3313B10-01
- 1000A-L3313B10-04

- 1000A-L3313B30-01
- 1000A-L3313B30-04

- 1000A-L3313B50-01
- 1000A-L3313B50-04





DADO



Acabado antracita – Anthracite finish
 Opciones de acabado a consultar
 Finish options available for consultation

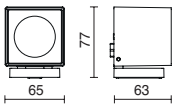

LED COB AC 7W 680lm **3000K**

LED COB AC 7W 700lm **4000K**

■ 922A-L3108B-04

■ 922A-L3308B-04



■ 922B-L3108B-04

■ 922B-L3308B-04

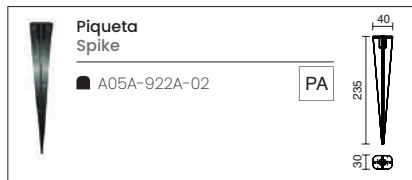

DADO



Acabado antracita – Anthracite finish

Opciones de acabado a consultar – Finish options available for consultation

Consultar opciones de regulación

Consult regulation options

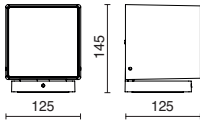

LED COB 12W 1700lm **3000K**

LED COB 12W 1780lm **4000K**

■ 922C-L3114B-04	■ 922C-L3314B-04	10°
■ 922C-L31RDB-04	■ 922C-L33RDB-04	10°
■ 922D-L3114B-04	■ 922D-L3314B-04	56°
■ 922D-L31RDB-04	■ 922D-L33RDB-04	56°



GIBSON



Acabado negro – Black finish

Conector IP67 incluido
IP67 connector included

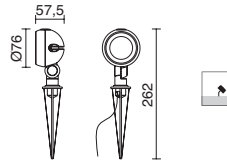
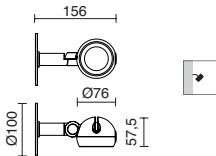

LED 6W 680lm 3000K

■ 998A-L3106E-02



LED 6W 680lm 4000K

■ 998A-L3306E-02



LED 10W 1200lm 3000K

■ 998B-L3110E-02



LED 10W 1200lm 4000K

■ 998B-L3310E-02



LED 6W 680lm 3000K

■ 998C-L3106E-02



LED 6W 680lm 4000K

■ 998C-L3306E-02



LED 10W 1200lm 3000K

■ 998D-L3110E-02



LED 10W 1200lm 4000K

■ 998D-L3310E-02



Alimentador – Power supply

max. 30W

B02E-X3330E-00

max. 75W

B02E-X3375E-00





LANCE



Acabado antracita – Anthracite finish
 Opciones de acabado a consultar
 Finish options available for consultation

Conector IP67 incluido
 IP67 connector included

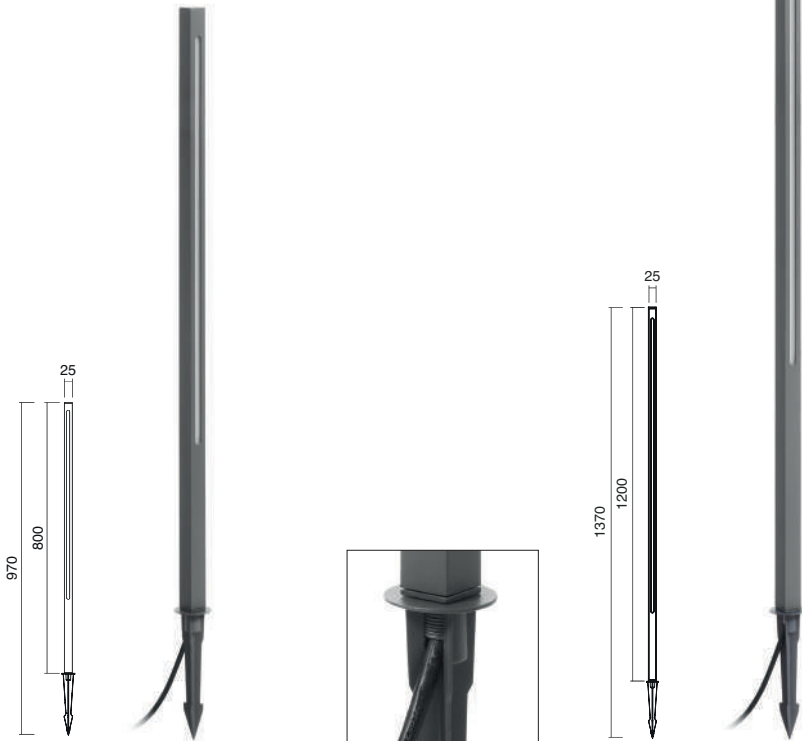

LED SMD AC 12W 1150lm **3000K**
 ■ 1024A-L3112BX0-04

LED SMD AC 18W 1800lm **3000K**
 ■ 1024A-L3118BX0-04

LED SMD AC 12W 1280lm **4000K**
 ■ 1024A-L3312BX0-04

LED SMD AC 18W 2000lm **4000K**
 ■ 1024A-L3318BX0-04

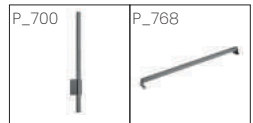



TIR



Acabado negro o gris – Black or grey finish

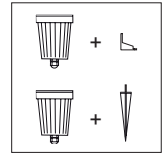
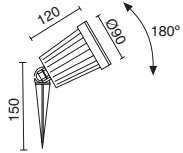

GU10 LED 5W 3000K 345lm (36°)

■ 319A-L2105A-02

■ 319A-L2105A-03

ABBI



Acabado antracita – Anthracite finish

Lamps P_860

Connectors P_861

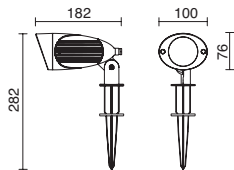

GU10 Led/Hal 50W max.

■ 485A-G21X1A-04

BAMBOLA

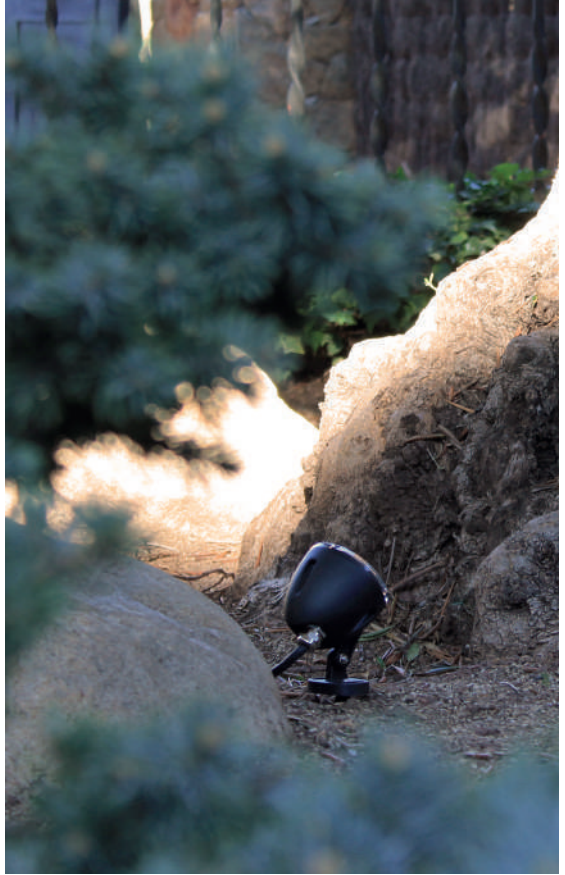

TERMO PLASTIC	PMMA (TRANS)	▶	◀	▼	220V 240V AC	LED	IP 67	IK 08	70.000h L80 B10	CRI >80	145°	2m	IP44	SEA SIDE SUITABLE
---------------	--------------	---	---	---	--------------------	-----	-------	-------	--------------------	---------	------	----	------	----------------------

Acabado negro – Black finish

 Connectors P_861

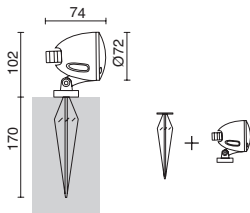

LED COB 4W 534lm **3000K**

LED COB 4W 561lm **4000K**

■ 025C-L3106B10-02

■ 025C-L3306B10-02



■ 025C-L3106B30-02

■ 025C-L3306B30-02



¿Cómo instalar una baliza?



How to install a bollard?



Bollards_

PALAU



Acabado negro – Black finish

Conector IP67 incluido
IP67 connector included

Con tornillos antirrobo
With anti-theft screws

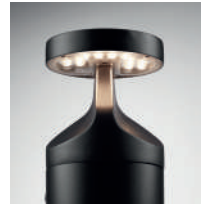
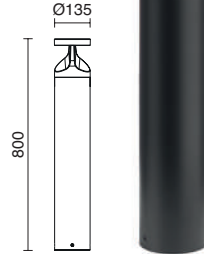
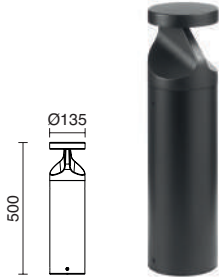

LED SMD 21W 2500lm **2200K**

■ 1051A-L2925AB0-02

■ 1051A-L2925ABD-02



■ 1051A-L2925ABG-02



LED SMD 21W 2500lm **2200K**

■ 1051B-L2925AB0-02

■ 1051B-L2925ABD-02



■ 1051B-L2925ABG-02



LED SMD 21W 2900lm **2700K**

■ 1051A-L3025AB0-02

■ 1051A-L3025ABD-02



■ 1051A-L3025ABG-02



LED SMD 21W 2900lm **2700K**

■ 1051B-L3025AB0-02

■ 1051B-L3025ABD-02



■ 1051B-L3025ABG-02



LED SMD 21W 3100lm **3000K**

■ 1051A-L3125AB0-02

■ 1051A-L3125ABD-02



■ 1051A-L3125ABG-02



LED SMD 21W 3100lm **3000K**

■ 1051B-L3125AB0-02

■ 1051B-L3125ABD-02



■ 1051B-L3125ABG-02



LED SMD 21W 3100lm **4000K**

■ 1051A-L3325AB0-02

■ 1051A-L3325ABD-02



■ 1051A-L3325ABG-02



LED SMD 21W 3100lm **4000K**

■ 1051B-L3325AB0-02

■ 1051B-L3325ABD-02



■ 1051B-L3325ABG-02



 Instalar sobre suelo rígido. En césped o tierra, añadir pilastra de cemento.
Install on rigid ground. On grass or earth, add pilaster cement.

Versión con sensor PIR o kit de emergencia a consultar
Version with PIR sensor or emergency kit to be consulted



DUOMO

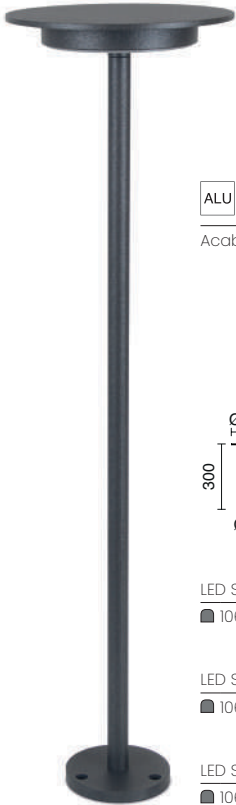

Acabado antracita – Anthracite finish

Drivers P_862

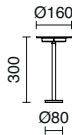

LED SMD 11W 1420lm **2700K**
 ■ 1069B-L3011FC0-04

LED SMD 11W 1420lm **3000K**
 ■ 1069B-L3111FC0-04

LED SMD 11W 1510lm **4000K**
 ■ 1069B-L3311FC0-04



LED SMD 11W 1420lm **2700K**
 ■ 1069C-L3011FC0-04

LED SMD 11W 1420lm **3000K**
 ■ 1069C-L3111FC0-04

LED SMD 11W 1510lm **4000K**
 ■ 1069C-L3311FC0-04

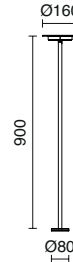

LED SMD 11W 1420lm **2700K**
 ■ 1069D-L3011FC0-04

LED SMD 11W 1420lm **3000K**
 ■ 1069D-L3111FC0-04

LED SMD 11W 1510lm **4000K**
 ■ 1069D-L3311FC0-04

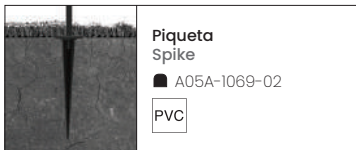



 Instalar sobre suelo rígido. En césped o tierra, añadir pilastra de cemento.
 Install on rigid ground. On grass or earth, add pilaster cement.



BUCKET

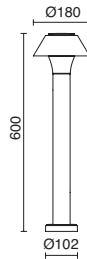
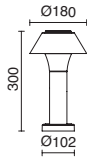

Acabado antracita – Anthracite finish



LED SMD 10,5W 1680lm **3000K**

■ 976B-L3110B-04

LED SMD 10,5W 1770lm **4000K**

■ 976B-L3310B-04

LED SMD 10,5W 1680lm **3000K**

■ 976B-L31RCB-04



LED SMD 10,5W 1770lm **4000K**

■ 976B-L33RCB-04



LED SMD 10,5W 1680lm **3000K**

■ 976C-L3110B-04

LED SMD 10,5W 1770lm **4000K**

■ 976C-L3310B-04

LED SMD 10,5W 1680lm **3000K**

■ 976C-L31RCB-04



LED SMD 10,5W 1770lm **4000K**

■ 976C-L33RCB-04



Instalar sobre suelo rígido. En césped o tierra, añadir pilastra de cemento.
Install on rigid ground. On grass or earth, add pilaster cement.

P_710





STONE



Conector IP67 incluido
IP67 connector included

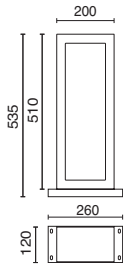

LED SMD 6W 400lm 3000K

- 965F-L3106B-NB
- 965F-L3106B-NN

 Instalar sobre suelo rígido. En césped o tierra, añadir pilastra de cemento.
Install on rigid ground. On grass or earth, add pilaster cement.

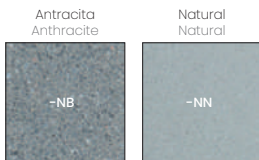



DION

by Jordi Blasi



Acabado antracita – Anthracite finish

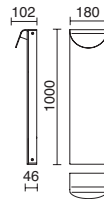
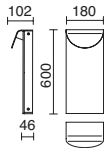
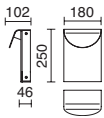

LED SMD 8,5W 1500lm 3000K

- 926A-L3109B-80
- 926A-L3109B-81
- 926A-L3109B-82
- 926A-L3109B-83

LED SMD 8,5W 1500lm 3000K

- 926B-L3109B-80
- 926B-L3109B-81
- 926B-L3109B-82
- 926B-L3109B-83

LED SMD 8,5W 1500lm 3000K

- 926C-L3109B-80
- 926C-L3109B-81
- 926C-L3109B-82
- 926C-L3109B-83

 Instalar sobre suelo rígido. En césped o tierra, añadir pilastra de cemento.
Install on rigid ground. On grass or earth, add pilaster cement.

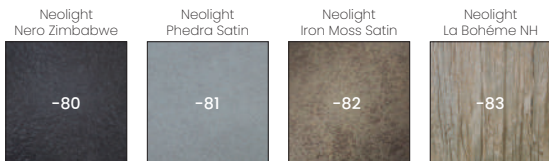



DAIN



Acabado blanco, negro, gris o marrón óxido
White, black, grey or oxide brown finish

Disponible en 91°
Available in 91°

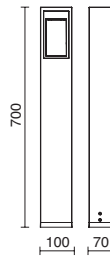
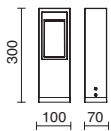

LED SMD 4,5W 500lm 3000K

- 929C-L3105B-02
- 929C-L3105B-03
- 929C-L3105B-90

LED SMD 4,5W 500lm 3000K

- 929D-L3105B-02
- 929D-L3105B-03
- 929D-L3105B-90

Reflector decorativo opcional – Optional decorative reflector

- A13B-929-01
- A13B-929-02
- A13B-929-03
- A13B-929-47
- A13B-929-90

Blanco – White

Negro – Black

Gris – Grey

Oro – Gold

Marrón óxido
Oxide brown

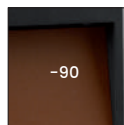
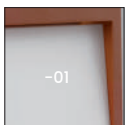

P_736



Instalar sobre suelo rígido. En césped o tierra, añadir pilastro de cemento.
Install on rigid ground. On grass or earth, add plaster cement.



TURRET



Acabado antracita – Anthracite finish

Conector IP67 incluido
IP67 connector included

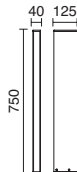

LED SMD 10W 1300lm **3000K**

■ 1018A-L3109AA0-04

LED SMD 13W 1750lm **3000K**

■ 1018B-L3112AA0-04

LED SMD 10W 1400lm **4000K**

■ 1018A-L3309AA0-04

LED SMD 13W 1850lm **4000K**

■ 1018B-L3312AA0-04



Instalar sobre suelo rígido. En césped o tierra, añadir pilastra de cemento.
Install on rigid ground. On grass or earth, add pilaster cement.



AURA



Acabado negro o marrón óxido — Black or oxide brown finish

Consultar opciones de regulación
Consult regulation options

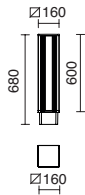
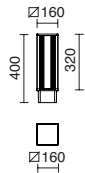
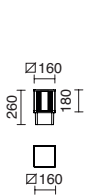

LED SMD 12W 1760lm **3000K**

- 932C-L3114B-02
- 932C-L3114B-90

- 932C-L31RDB-02
- 932C-L31RDB-90

LED SMD 23W 3480lm **3000K**

- 932D-L3125B-02
- 932D-L3125B-90

- 932D-L31RDB-02
- 932D-L31RDB-90

LED SMD 34W 5000lm **3000K**

- 932A-L3133B-02
- 932A-L3133B-90

- 932A-L31RDB-02
- 932A-L31RDB-90



LED SMD 12W 1840lm **4000K**

- 932C-L3314B-02
- 932C-L3314B-90

- 932C-L33RDB-02
- 932C-L33RDB-90

LED SMD 23W 3680lm **4000K**

- 932D-L3325B-02
- 932D-L3325B-90

- 932D-L33RDB-02
- 932D-L33RDB-90

LED SMD 34W 5240lm **4000K**

- 932A-L3333B-02
- 932A-L3333B-90

- 932A-L33RDB-02
- 932A-L33RDB-90



Instalar sobre suelo rígido. En césped o tierra, añadir pilastra de cemento.
Install on rigid ground. On grass or earth, add pilaster cement.

AURA



Video



Acabado negro o marrón óxido – Black or oxide brown finish

Consultar opciones de regulación
Consult regulation options

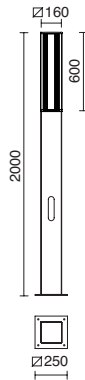

LED SMD 34W 5000lm **3000K**

- 932B-L3133B-02
- 932B-L3133B-90
- 932B-L31RDB-02
- 932B-L31RDB-90

LED SMD 34W 5240lm **4000K**

- 932B-L3333B-02
- 932B-L3333B-90
- 932B-L33RDB-02
- 932B-L33RDB-90



Instalar sobre suelo rígido. En césped o tierra, añadir pilastra de cemento.
Install on rigid ground. On grass or earth, add pilaster cement.

MAXIMA



Acabado antracita – Anthracite finish
 Disponible con difusor opal – Available with opal diffuser
 Opciones de acabado a consultar
 Finish options available for consultation

Disponible en 4000K – Available in 4000K

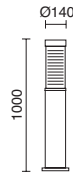
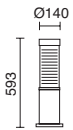

LED SMD 24W 3870lm **2700K**

LED SMD 24W 3870lm **2700K**

■ 388A-L3020B-04

■ 388B-L3020B-04

■ 388A-L30RDB-04

■ 388B-L30RDB-04



LED SMD 24W 3964lm **3000K**

LED SMD 24W 3964lm **3000K**

■ 388A-L3120B-04

■ 388B-L3120B-04

■ 388A-L31RDB-04

■ 388B-L31RDB-04



Instalar sobre suelo rígido. En césped o tierra, añadir pilastra de cemento.
 Install on rigid ground. On grass or earth, add pilaster cement.

MAXIMA

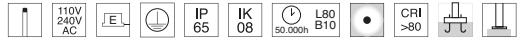

Acabado antracita – Anthracite finish
 Disponible con difusor opal – Available with opal diffuser
 Opciones de acabado a consultar
 Finish options available for consultation

Disponible en 4000K – Available in 4000K

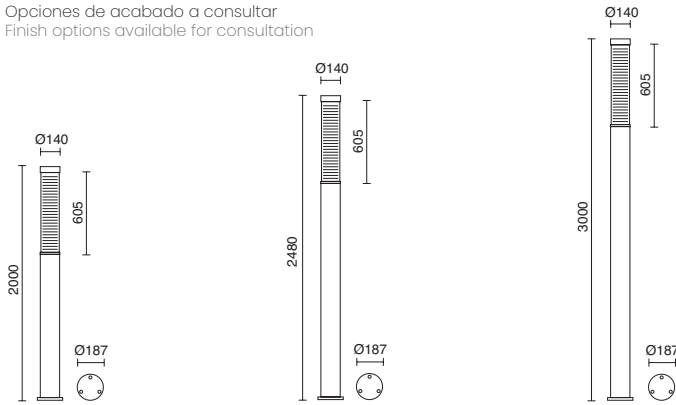

LED SMD 42W 6193lm **2700K**

LED SMD 42W 6193lm **2700K**

LED SMD 42W 6193lm **2700K**

■ 388C-L3036B-04

■ 388D-L3036B-04

■ 388E-L3036B-04

■ 388C-L30RDB-04

■ 388D-L30RDB-04

■ 388E-L30RDB-04



LED SMD 42W 6342lm **3000K**

LED SMD 42W 6342lm **3000K**

LED SMD 42W 6342lm **3000K**

■ 388C-L3136B-04

■ 388D-L3136B-04

■ 388E-L3136B-04

■ 388C-L31RDB-04

■ 388D-L31RDB-04

■ 388E-L31RDB-04



Versión con puerta de registro. Consulte disponibilidad.
 Available with inspection door. Please ask availability.



Instalar sobre suelo rígido. En césped o tierra, añadir pilastra de cemento.
 Install on rigid ground. On grass or earth, add pilaster cement.

BINDELLA



500 h
LAB SALT TEST

Acabado antracita – Anthracite finish

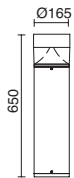

LED SMD 7W 960lm 3000K

■ 554A-L0108A-04

■ 554A-L01RDB-04



Instalar sobre suelo rígido. En césped o tierra, añadir pilastra de cemento.
Install on rigid ground. On grass or earth, add pilaster cement.

Versión con kit de emergencia a consultar
Version with emergency kit to be consulted



CLINA

by Novolux Technical Studio



Acabado negro o marrón óxido – Black or oxide brown finish

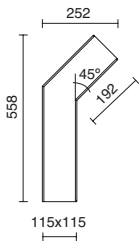

LED COB AC 10W 830lm **2700K**

- 492A-L3805B-02
- 492A-L3805B-90

LED COB AC 10W 900lm **3000K**

- 492A-L0105B-02
- 492A-L0105B-90

LED COB AC 10W 940lm **4000K**

- 492A-L0205B-02
- 492A-L0205B-90



Instalar sobre suelo rígido. En césped o tierra, añadir pilastra de cemento.
Install on rigid ground. On grass or earth, add pilaster cement.

MINI NICO



Acabado gris, antracita o marrón óxido – Grey, anthracite or oxide brown finish

Lamps P_859

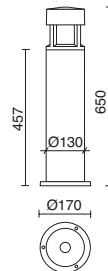
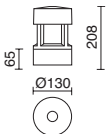

E27 Led/Hal/Fluo 70W max.

- 201A-G05X1A-03
- 201A-G05X1A-04
- 201A-G05X1A-90

E27 Led 15W max.

- 201B-G05X1A-03
- 201B-G05X1A-04
- 201B-G05X1A-90



Instalar sobre suelo rígido. En césped o tierra, añadir pilastra de cemento.
Install on rigid ground. On grass or earth, add pilaster cement.

NOVA



Acabado negro – Black finish

Consultar otras opciones de acabado
Consult other finishing options

Lamps P_859

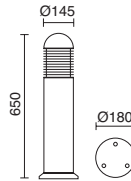
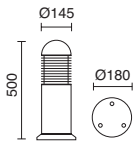

LED SMD AC 15W 2300lm **3000K**

■ 222B-L3115B-02



LED SMD AC 15W 2300lm **3000K**

■ 222C-L3115B-02



LED SMD AC 15W 2300lm **4000K**

■ 222B-L3315B-02



LED SMD AC 15W 2300lm **4000K**

■ 222C-L3315B-02



E27 Led 15W max.

■ 222B-G05XIA-02



E27 Led 15W max.

■ 222C-G05XIA-02



 Instalar sobre suelo rígido. En césped o tierra, añadir pilastra de cemento.
Install on rigid ground. On grass or earth, add pilaster cement.

COK

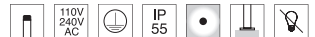

Acabado negro o antracita – Black or anthracite finish

Consultar otras opciones de acabado
Consult other finishing options

Lamps P_859

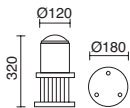

E27 Led/Hal/Fluo 70W max.

- 068A-G05X1A-02
- 068A-G05X1A-04

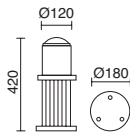

E27 Led/Hal/Fluo 70W max.

- 068B-G05X1A-02
- 068B-G05X1A-04

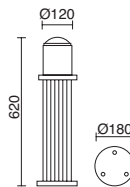

E27 Led/Hal/Fluo 70W max.

- 068C-G05X1A-02
- 068C-G05X1A-04

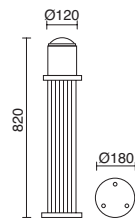

E27 Led/Hal/Fluo 70W max.

- 068D-G05X1A-02
- 068D-G05X1A-04



Instalar sobre suelo rígido. En césped o tierra, añadir pilastra de cemento.
Install on rigid ground. On grass or earth, add pilaster cement.

MIRCO

PPH



Acabado negro – Black finish

Lamps P_859

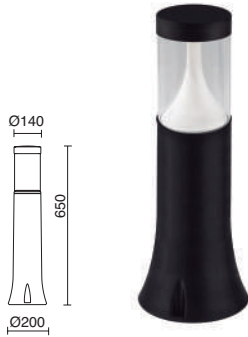

LED SMD 10,5W 1530lm **3000K**

LED SMD 10,5W 1590lm **4000K**

■ 669B-L0113B-02

■ 669B-L0213B-02

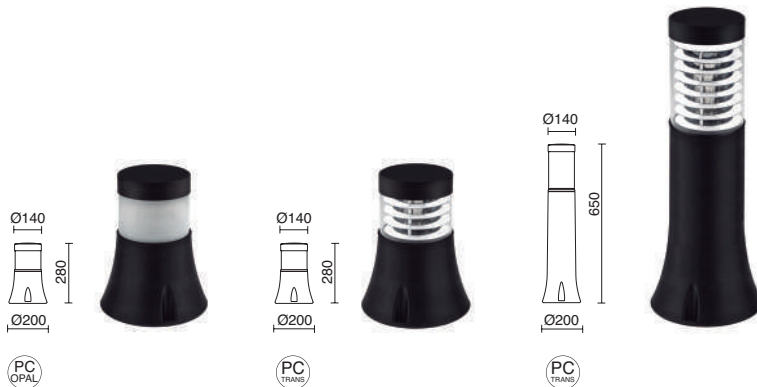

PC OPAL

PC TRANS

PC TRANS

E27 Led/Fluo 11W max.

E27 Led/Fluo 11W max.

E27 Led/Fluo 23W max.

■ 669C-G05XIA-02

■ 669D-G05XIA-02

■ 669A-G05XIA-02



 Instalar sobre suelo rígido. En césped o tierra, añadir pilastra de cemento.
Install on rigid ground. On grass or earth, add pilaster cement.



Urban Lights_

FANAL



Acabado negro – Black finish

Disponibile **MidNight**
Multi-Step Dimming

Postes – Poles P_ 844-845

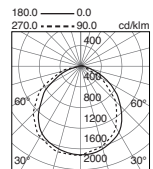
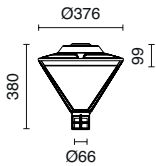

LED SMD 47W 8240lm **3000K**

LED SMD 47W 9050lm **4000K**

■ 1035A-L3150AA0-02

■ 1035A-L3350AA0-02





VENT



Video



Acabado antracita – Anthracite finish

Consultar otras opciones de regulación
Consult other regulation options

Disponible **MidNight**
Multi-Step Dimming

Postes – Poles P_844-845



LED SMD **36W** 5770lm **3000K**

■ 1001A-L3140A90-04

■ 1001A-L3140A9D-04

LED SMD **68W** 10750lm **3000K**

■ 1001A-L3175A90-04

■ 1001A-L3175A9D-04

LED SMD **36W** 6000lm **4000K**

■ 1001A-L3340A90-04

■ 1001A-L3340A9D-04

LED SMD **68W** 11800lm **4000K**

■ 1001A-L3375A90-04

■ 1001A-L3375A9D-04

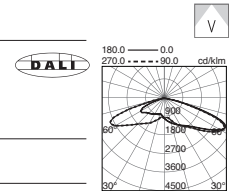

LED SMD **36W** 5770lm **3000K**

■ 1001B-L3140A90-04

■ 1001B-L3140A9D-04

LED SMD **68W** 10750lm **3000K**

■ 1001B-L3175A90-04

■ 1001B-L3175A90-D4

LED SMD **36W** 6000lm **4000K**

■ 1001B-L3340A90-04

■ 1001B-L3340A9D-04

LED SMD **68W** 11800lm **4000K**

■ 1001B-L3375A90-04

■ 1001B-L3375A9D-04

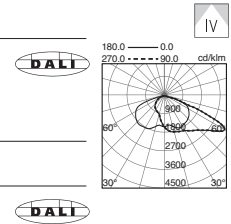

Incorpora válvula depresora para evitar la entrada de humedad.
It incorporates a depressor valve to prevent the entry of moisture.



FENDER



Video



Acabado antracita – Anthracite finish (RAL7037)

Conector IP67 incluido – IP67 connector included
 Consultar opciones de regulación – Consult regulation options

Postes – Poles P_ 844-845

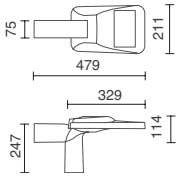

LED SMD **21W** 3025lm **3000K**

■ 999A-L0125A-04

LED SMD **21W** 3505lm **4000K**

■ 999A-L0225A-04

LED SMD **47W** 6770lm **3000K**

■ 999A-L0150A-04

LED SMD **47W** 7615lm **4000K**

■ 999A-L0250A-04

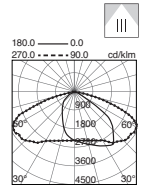

LED SMD **21W** 3025lm **3000K**

■ 999B-L0125A-04

LED SMD **21W** 3505lm **4000K**

■ 999B-L0225A-04

LED SMD **47W** 6770lm **3000K**

■ 999B-L0150A-04

LED SMD **47W** 7615lm **4000K**

■ 999B-L0250A-04

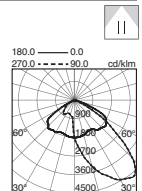

2 posiciones y orientación de $\pm 15^\circ$
 2 positions and $\pm 15^\circ$ orientable



ARYA

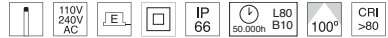

Acabado aluminio anodizado – Anodized aluminium finish

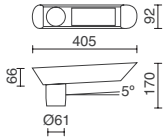

IK06 (lente – lens)

IK10 (cubierta – cover)

Consultar opciones de regulación
Consult regulation options

Postes – Poles P_ 844-845

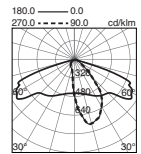

LED SMD 27W 4450lm **2700K**

■ 673A-L3024A-39

LED SMD 27W 4700lm **3500K**

■ 673A-L0224A-39

LED SMD 27W 4150lm **2700K**

■ 673A-L3024AAD-39

LED SMD 27W 4400lm **3500K**

■ 673A-L3224AAD-39



LED SMD 36W 5350lm **2700K**

■ 673A-L3036A-39

LED SMD 36W 5700lm **3500K**

■ 673A-L0236A-39

LED SMD 36W 5550lm **2700K**

■ 673A-L3036AAD-39

LED SMD 36W 5900lm **3500K**

■ 673A-L3236AAD-39



VICO



Acabado antracita – Anthracite finish

Disponibile  MidNight

Postes – Poles P_ 844-845

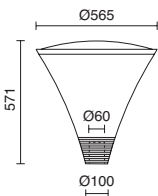

LED SMD 32W 4040lm **3000K**

■ 568A-L0135B-04

LED SMD 32W 4230lm **4000K**

■ 568A-L0235B-04

LED SMD 50W 5530lm **3000K**

■ 568A-L0150B-04

LED SMD 50W 5785lm **4000K**

■ 568A-L0250B-04

POSTES — POLES

ALU
ANOD



SEA SIDE
SUITABLE



Acabado negro o aluminio anodizado — Black or anodised aluminium finish

Consultar disponibilidad de acabados pintados RAL

Consult availability of RAL painted finishes

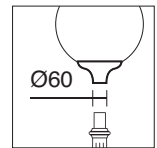
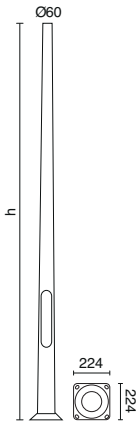

- C02B-32-02 (h3000)
- C02C-32-02 (h3500)
- C02D-32-02 (h4000)
- C02F-32-02 (h5000)

- C03B-32-39 (h3000)
- C03C-32-39 (h3500)
- C03D-32-39 (h4000)
- C03F-32-39 (h5000)



Anclaje — Anchorage

A02D-004-00



Caja de conexión opcional
Optional junction box

500V 80A D01/E14-16A (273x90x76cm)

B03F-X33X1A-29



IP
54



Instalar sobre suelo rígido. En césped o tierra, añadir pilastra de cemento.
Install on rigid ground. On grass or earth, add pilaster cement.

POSTES — POLES

RESIN

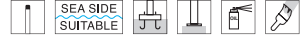

Acabado negro — Black finish

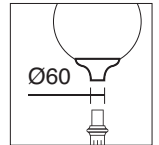
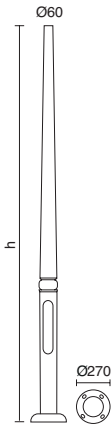

- C04A-32-02 (h3000)
- C04B-32-02 (h3500)
- C04C-32-02 (h4000)
- C04D-32-02 (h4500)
- C04E-32-02 (h5000)















Instalar sobre suelo rígido. En césped o tierra, añadir pilastra de cemento.
Install on rigid ground. On grass or earth, add pilaster cement.

Underwater_

CONTROL RGB



- | | | |
|--|--|---|
|  WiFi wireless Control |  TUYA APP Control |  Remote Control |
|  Bluetooth Control |  20 Scene Mode |  Support scene customization |
|  Voice control Alexa, Google, etc |  Device sharing |  Brightness Adjustment |
|  Music Rhythm |  Speed Adjustment |  Timer Shedule |

B05Q-X33X2X-03

- Máximo 1 controlador para conectar 20 luminarias (potencia máxima 600W)
 - Máximo 1 amplificador para conectar 10 luminarias (potencia máxima 300W)
 - Utilice el amplificador para mejorar la señal si conecta más de 20 luminarias.
 - Asegúrese de que la línea de alimentación pueda soportar una tensión de 12V AC.
 - Para mantener una buena señal WiFi, por favor, elija un router 2.4G.
- 1 controller maximum connect with 20pcs lamps (max power 600W)
 - 1 amplifier maximum connect with 10pcs lamps (max power 300W)
 - Use the amplifier to enhance the signal if lamps more than 20pcs
 - Make sure the power line is strong enough to carry the voltage 12V AC).
 - To maintain good WiFi signal, please choose 2.4G router

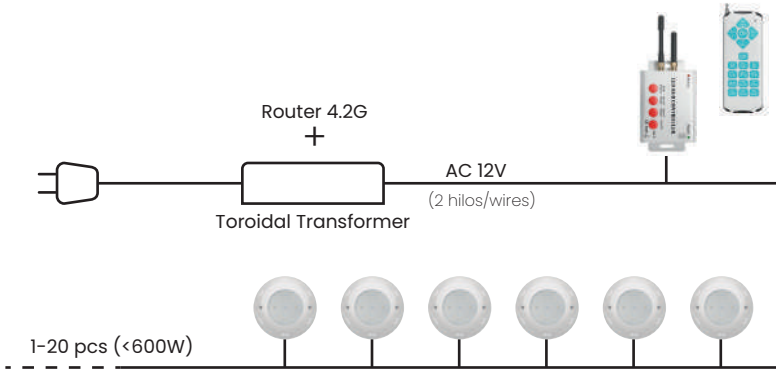

¿Cómo sustituir o instalar una lámpara RGB de piscina y su sistema de control?



How to replace or install an RGB pool light and its control system?



CONTROL DMX RGB NEW



Controlador DMX RGB
DMX RGB controller (190 x 125 x 40 mm)

CONT.DMX512_5CBL

- Controlador LED RGB DMX512 (tarjeta incluida).
- Conexión de 5 cables.
- 30 tipos de programas (por defecto).
- Un controlador puede conectar entre 1 y 20 luminarias DMX.
- RGB DMX512 LED controller (card included).
- 5 wire connection.
- 30 program types (default).
- One controller can connect between 1 and 20 DMX luminaires.

110V
240V
AC



Amplificador DMX RGB
DMX RGB amplifier (103 x 34 x 21 mm)

CONT.AMPL_DM512_5CBL

- Conexión de 5 cables.
- 30 tipos de programas (por defecto).
- Un amplificador puede conectar entre 1 y 10 luminarias DMX.
- 5 wire connection.
- 30 program types (default).
- One amplifier can connect between 1 and 10 DMX luminaires.

12V
DC

24V
DC



Descodificador DMX RGB
DMX RGB decoder (73 x 45 x 19 mm)

CONT.DEC_DM512_5CBL

- Configuración de la dirección DMX para cada luminaria.
- Conexión de 5 cables.
- DMX address configuration for each luminaire.
- 5 wire connection.

12V
DC

24V
DC

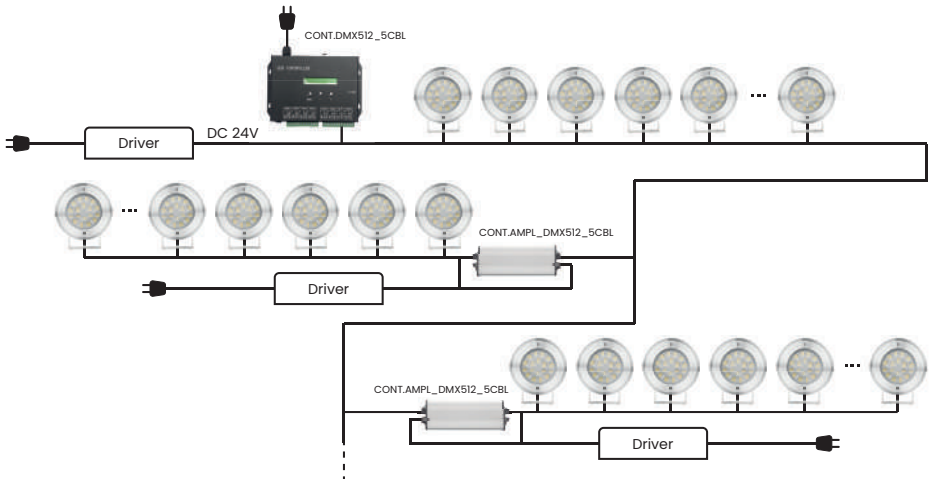

PAR56



Acabado blanco – White finish

En funcionamiento SIEMPRE SUMERGIDA (hasta 2m).
Keep ALWAYS UNDER WATER when ON (up to 2m).



6500K

LED SMD 18W 2500lm

□ 233D-L0318D-01



RGB (2 hilos/wires)

LED SMD 18W 730lm

□ 233D-L0418D-01



BELT



Acabado blanco – White finish

Instalación en piscinas hormigonadas.
En funcionamiento SIEMPRE SUMERGIDA (hasta 2m).

Suitable for installation in concrete pools.
Keep ALWAYS UNDER WATER when ON (up to 2m).

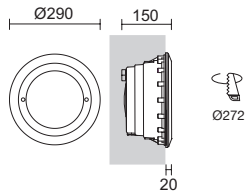

6500K

LED SMD 18W 2500lm

□ 030D-L0318D-01



RGB (2 hilos/wires)

LED SMD 18W 730lm

□ 030D-L0418D-01



Alimentador – Power supply

Max. 350W (160x130x100mm)

Max. 700W (210x140x110mm)

B02I-X33F9D-02

B02I-X33G1D-02

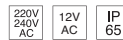

IN OUT



MINI PRAGA

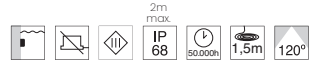

Acabado blanco – White finish

Instalación en piscinas hormigonadas.
En funcionamiento SIEMPRE SUMERGIDA (hasta 2m).

Suitable for installation in concrete pools.
Keep ALWAYS UNDER WATER when ON (up to 2m).

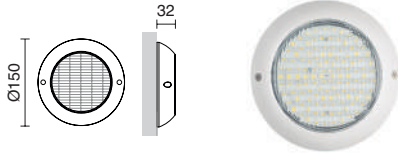

6500K

LED SMD 12W 1680lm

□ 253D-L0312D-01



RGB (2 hilos/wires)

LED SMD 12W 530lm

□ 253D-L0412D-01



PRAGA

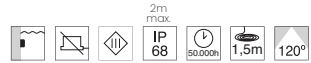

Acabado blanco – White finish

Instalación en piscinas hormigonadas.
En funcionamiento SIEMPRE SUMERGIDA (hasta 2m).

Suitable for installation in concrete pools.
Keep ALWAYS UNDER WATER when ON (up to 2m).

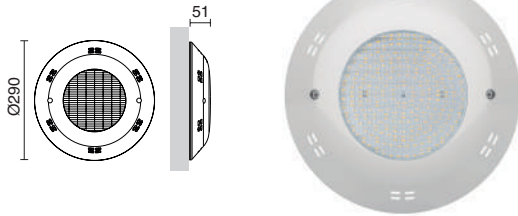

6500K

LED SMD 18W 2500lm

□ 253E-L0318D-01



RGB (2 hilos/wires)

LED SMD 18W 730lm

□ 253E-L0418D-01



Alimentador – Power supply

Max. 350W (160x130x100mm)

Max. 700W (210x140x110mm)

B02I-X33F9D-02

B02I-X33G1D-02

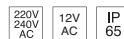

IN OUT

PAL NEW

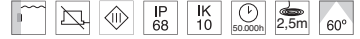

Acabado inox – Stainless steel finish

Instalación en piscinas hormigonadas.
Suitable for installation in concrete pools.

En funcionamiento SIEMPRE SUMERGIDA (hasta 2m).
Keep ALWAYS UNDER WATER when ON (up to 2m).

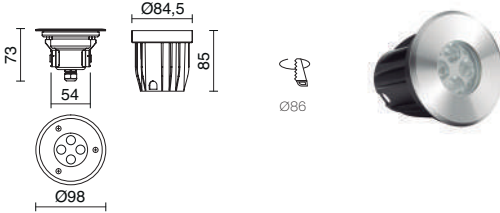

6500K

LED SMD 3W 300lm



RGB (2 hilos/wires)

LED SMD 3W 130lm



661B-L0303D-30

661B-L0403D-30



Alimentador – Power supply

Max. 350W (160x130x100mm)

Max. 700W (210x140x110mm)

B02I-X33F9D-02

B02I-X33G1D-02

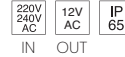

CUP

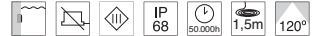

Acabado blanco – White finish

Instalación en piscinas hormigonadas.
Suitable for installation in concrete pools.

En funcionamiento SIEMPRE SUMERGIDA (hasta 2m).
Keep ALWAYS UNDER WATER when ON (up to 2m).

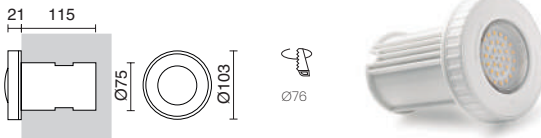

6500K

LED SMD 3W 420lm



RGB (2 hilos/wires)

LED SMD 3W 90lm



077C-L0303D-01

077C-L0403D-01



Alimentador – Power supply

Max. 350W (160x130x100mm)

Max. 700W (210x140x110mm)

B02I-X33F9D-02

B02I-X33G1D-02

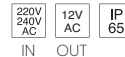

GAMBLE NEW



Acabado inox – Stainless steel finish

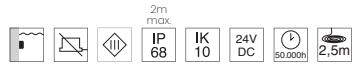

2m max.
 Instalación en piscinas hormigonadas.
 En funcionamiento SIEMPRE SUMERGIDA (hasta 2m).

Suitable for installation in concrete pools.
 Keep ALWAYS UNDER WATER when ON (up to 2m).

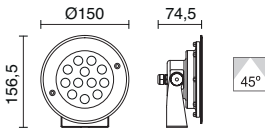

5700K

LED SMD 18W 1600lm

■ 382C-L0318D-30

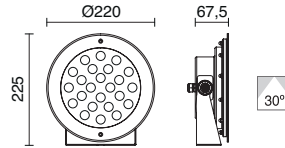

5700K

LED SMD 24W 2200lm

■ 382D-L0324D-30



Mando Universal – Universal remote control

CONT.RT10

info p_230



Controlador RGB/RGBW

RGB / RGBW controller (175 x 45 x 27 mm)

CONT.V4WP

IP67

info p_234

RGB (4 hilos/wires)
 LED SMD 18W 600lm

■ 382C-L0418D-30

RGB (4 hilos/wires)
 LED SMD 24W 900lm

■ 382D-L0424D-30

RGB DMX (5 hilos/wires)
 LED SMD 18W 600lm

■ 382C-L04DMX-30



RGB DMX (5 hilos/wires)
 LED SMD 24W 900lm

■ 382D-L04DMX-30



Controlador, amplificador y descodificador DMX RGB
 DMX RGB controller, amplifier and decoder

info p_849

FOCUS

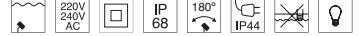

Acabado negro – Black finish

En funcionamiento SIEMPRE SUMERGIDA (hasta 2m).
Keep ALWAYS UNDER WATER when ON (up to 2m).

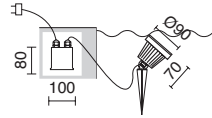

GU5,3 LED 3000K 5W (36°)

■ 113A-L2305D-02



GU5,3 LED 3000K 5W (36°)

■ 113A-L2305B-02

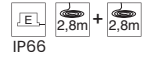

Alimentador – Power supply
Max. 50W (80x78x60mm)
B02J-X3350D-02

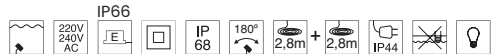
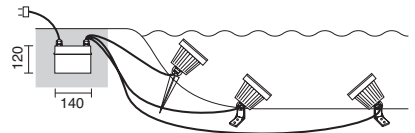
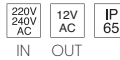

Acabado negro – Black finish

En funcionamiento SIEMPRE SUMERGIDA (hasta 2m).
Keep ALWAYS UNDER WATER when ON (up to 2m).

GU5,3 LED 3000K 3x5W (36°)

■ 113B-L2305B-02



LED T2

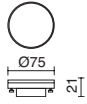

GX53 LED T2 3W 350lm **3000K/4000K/6500K**

378A-L4103A-01

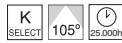

GX53 LED T2 3W 350lm **4000K**

378A-L3103A-02

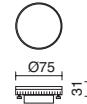
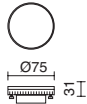

GX53 LED T2 6W 480lm **3000K**

378A-L3106A-01

GX53 LED T2 6W 480lm **4000K**

378A-L3106A-02

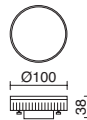
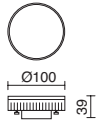

GX53 LED T2 7W 700lm **4000K**

378B-L3107A-02

GX53 LED T2 10W 1200lm **3000K/4000K/6500K**

378B-L5210A-01

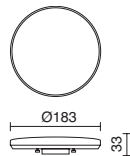
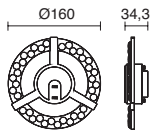

GX53 LED T2 15W/9W 1300lm **2700K/4000K**

378C-L4115A-01



GX53 LED T2 11W 1300lm **3000K**

378C-L3111A-01

GX53 LED T2 11W 900lm **4000K**

378C-L3111A-02

LED FILAMENT

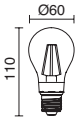

E27 LED 6W 800lm **2700K**
632C-L0506B-01



E27 LED 6W 800lm **4000K**
632C-L0506B-02



E27 LED 4W 450lm 2000K-2700K (Ø45)
632H-L0504B-01

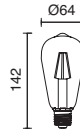

E27 LED 4W 470lm **2700K**
632G-L0504B-01



E27 LED 3W 330lm (Ø45) **3000K**
632J-L0503B-01

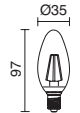

E14 LED 4W 470lm **2700K**
632D-L0404B-01

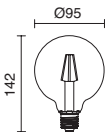

E27 LED 4W 470lm **2700K**
632F-L0504B-01



E14 LED 4W 470lm **2700K**
632E-L0404B-01

LED PRO

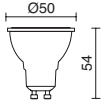

GU10 LED 3,5W 350lm **2700K/4000K**
578A-L4104A-01

GU10 LED 3,5W 400lm **4000K**
578A-L2104A-02

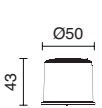

LED MODUL 6W 570lm/650lm **2700K/4000K**
578C-L4106B-01



G9



G9 LED 2,5W 160lm **3000K**
369D-L2003B-01

G9 LED 2,5W 160lm **4000K**
369D-L2003B-02



G9 LED 1,7W 150lm **3000K**
967A-L0102A-01

G9 LED 1,7W 150lm **4000K**
967A-L0102A-02

R7s



R7s LED 3,5W
968A-L4104A-02

2700K	325lm
4000K	365lm
6500K	365lm

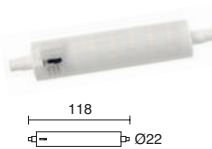

R7s LED 7,5W
968B-L4108A-02

2700K	680lm
4000K	775lm
6500K	790lm

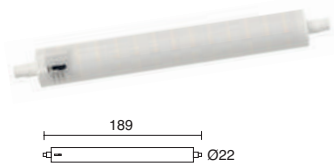

R7s LED 10,5W
968C-L4111A-02

2700K	1000lm
4000K	1130lm
6500K	1160lm

CONECTORES — CONNECTORS



Doble conector (3 polos) para cables-manguera entre Ø5-13 mm.
Double connector (3 poles) for wires-hoses between Ø5-13 mm.

B03A-X33X2A-02

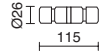

Triple conector (3 polos) para cables-manguera entre Ø9-12 mm.
Triple connector (3 poles) for wires-hoses between Ø9-12 mm.

B03N-X33X2A-02

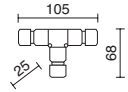

Triple conector (3 polos) para cables-manguera de Ø13,5 mm.
Triple connector (3 poles) for wires-hoses between Ø13,5 mm.

B03C-X33X2A-02

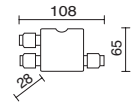

Triple conector (3 polos) para cables-manguera de Ø13,5 mm.
Triple connector (3 poles) for wires-hoses between Ø13,5 mm.

B03D-X33X2A-02

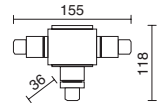

Doble conector (2 polos) para cables-manguera entre Ø5-9 mm.
Double connector (2 poles) for wires-hoses between Ø5-9 mm.

B03K-X33X2A-02

IP
68

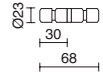

Doble conector (3 polos) para cables-manguera entre Ø5-9 mm.
Double connector (3 poles) for wires-hoses between Ø5-9 mm.

B03L-X33X2A-02

IP
68

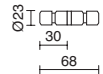

Doble conector (4 polos) para cables-manguera entre Ø5-9 mm.
Double connector (4 poles) for wires-hoses between Ø5-9 mm.

B03M-X33X2A-02

IP
68

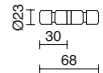

Doble conector (5 polos) para cables-manguera entre Ø5-13 mm.
Double connector (5 poles) for wires-hoses between Ø5-13 mm.

B03I-X33X2A-02



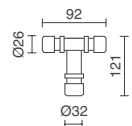

Triple conector (5 polos) para cables-manguera entre Ø7-13,5 mm.
Double connector (5 poles) for wires-hoses between Ø7-13,5 mm.

B03J-X33X2A-02













ALIMENTADORES — POWER SUPPLIES

	REF.	OUT				IN		SIZES	IP
		V	C	220-240V	110-127V	V	Freq.		
	B02A-X3316HN-01	-	350 mA DC	0-16W	-	220-240V AC	50/60 Hz	138x30x21	20
	B02A-X3323IN-01	-	500 mA DC	1,3-23W					
	B02A-X3323JN-01	-	700 mA DC	1,8-23W					
	B02G-X3306J-01	-	700 mA DC	6W	-	100-240V AC	50/60 Hz	58x40x20	20
	B02N-X3330J-01	-	700 mA DC	30W	-	220-240V AC	50/60 Hz	147x44x22	20











Corriente de salida ajustable – Adjustable output current

	REF.	OUT				IN		SIZES	IP
		V	C	220-240V	110-127V	V	Freq.		
	B02N-X3340M-01	-	800 mA DC 900 mA DC 1050 mA DC	40W	-	220-240V AC	50/60 Hz	147x43x30	20
	B02P-X3326HI-01	-	350 mA DC 500 mA DC 700 mA DC	26W	26W	100-240V AC	50/60 Hz	108x64x32	67
	B02P-X3340JM-01	-	500 mA DC 700 mA DC 1050 mA DC	40W	40W	100-240V AC	50/60 Hz	116x64x32	67





	REF.	OUT				IN		SIZES	IP
		V	C	220-240V	110-127V	V	Freq.		
	B02B-X3360B-01	12V AC	-	60W	-	220-240V AC	50/60 Hz	22x36x103	20
	B02B-X33A4B-01		-	150W	-			33x37x185	20
	B02E-X3330E-00	12V DC	-	30W	-	220-240V AC	50/60 Hz	131x42x34	67
	B02E-X3375E-00		-	75W	-			155x50x32	65
	B02J-X3350D-02	12V AC	-	50W	-	220-240V AC	50/60 Hz	80x78x60	65
	B02M-X33A5D-03	12V AC	-	200W	-	230V AC	50/60 Hz	108x104x99	20
	B02M-X33A9D-03		-	500W	-			120x132x108	20
	B02C-X33A7D-02	12V AC	-	300W	-	230V AC	50 Hz	120x140	66
	B02F-X33F9D-02	12V AC	-	350W	-	220-240V AC	50/60 Hz	175x155x110	65
	B02F-X33G1D-02	12V AC	-	700W	-	220-240V AC	50/60 Hz	175x155x110	65
	B02F-X33A8D-32	12V AC	-	400W	-	230V AC	50 Hz	220x110	20

ALIMENTADORES — POWER SUPPLIES

24V DC	REF.	OUT				IN		SIZES	IP
		V	C	220-240V	110-127V	V	Freq.		
	B02A-X33X2F-01	24V DC	-	15W	-	200-240V AC	50/60 Hz	111,5x44x19,1	20
	B02Q-X3335F-00	24V DC	-	35W	35W	90-264V AC	50/60 Hz	84x57x29,5	42
	B02Q-X3312F-01	24V DC	-	12W	12W	90-264V AC	50/60 Hz	77x40x29	42
	B02Q-X3396F-00	24V DC	-	96W	96W	90-264V AC	50/60 Hz	200,5x69,5x35	20
	B02C-X3330F-00	24V DC	-	30W	-	220-240V AC	50/60 Hz	153x41x32	20
	B02C-X3360F-00		-	60W	-	220-240V AC	50/60 Hz	180x52x30	20
	B02C-X3375F-00		-	75W	-	220-240V AC	50/60 Hz	180x52x30	20
	B02C-X33A3F-00		-	120W	-	220-240V AC	50/60 Hz	330x40x30	20
	B02L-X3340F-00 DALI - PUSH	24V DC	-	40W	-	220-240V AC	50/60 Hz	187x45x31	20
	B02L-X3380F-00 DALI - PUSH		-	80W	-	220-240V AC	50/60 Hz	290x45x31	20
	B02L-X33A4F-00 DALI - PUSH		-	150W	-	220-240V AC	50/60 Hz	290x45x31	20
	B02L-X33A6F-00 DALI - PUSH		-	250W	-	220-240V AC	50/60 Hz	431x45x31	20

	B02D-X3312F-00	24V DC	-	12W	-	220-240V AC	50/60 Hz	50x49x24	65
	B02R-X3335F-00	24V DC	-	35W	35W	90-264V AC	50/60 Hz	148x40x30	67
	B02R-X3360F-00		-	60W	60W	90-264V AC	50/60 Hz	162,5x42,5x32	67
	B02R-X33A1F-01		-	100W	100W	90-264V AC	50/60 Hz	191x63x37,5	67
	B02R-X33A4F-00		-	150W	-	180-305V AC	50/60 Hz	191x63x37,5	67
	B02H-X3360F-00 DALI	24V DC	-	60W	60W	90-305V AC	50/60 Hz	150x53x35	67
	B02H-X3390F-00 DALI		-	90W	90W	90-305V AC	50/60 Hz	171x63x37,5	67
	B02H-X33A3F-00 DALI		-	120W	120W	90-305V AC	50/60 Hz	190x52x37,5	67
	B02H-X33A5F-00 DALI		-	200W	200W	100-305V AC	50/60 Hz	195x63x39,5	67









































Más opciones de alimentadores de tensión constante de 24V en pag. 239
More 24V constant voltage power supply options on page 239









































48V DC	REF.	OUT				IN		SIZES	IP
		V	C	220-240V	110-127V	V	Freq.		
	B02V-X3375V-00	48V DC	-	75W	-	220-240 V AC	50/60 Hz	180x52x30	20
	B02V-X33J5V-00	48V DC	-	120W	-	220-240 V AC	50/60 Hz	300x40x30	20
	B32N-X33A1V-01	48V DC	-	100W	-	220-240 V AC	50/60 Hz	207,5x16x19	20
	B32N-X33A1V-02		-	100W	-	220-240 V AC	50/60 Hz	207,5x16x19	20
	B32N-X33A6V-01	48V DC	-	250W	-	220-240 V AC	50/60 Hz	268x22x43,5	20
	B32N-X33A6V-02		-	250W	-	220-240 V AC	50/60 Hz	268x22x43,5	20

ACABADOS — FINISHES

Los artículos de este catálogo se suministran según el modelo, con diferentes acabados. Estos vienen representados por las dos últimas cifras del código o en algunos modelos, podremos encontrar incluso 4 cifras de acabado y un recuadro de color. El color en las fotografías de producto es orientativo debido a las variaciones de las tonalidades que ocasiona el proceso de impresión.

Articles in this catalogue are supplied in different finishes. They are represented by the last two digits of the code or in some models, we can even find 4 finishing digits and a colored inset. The color in the product photographs is a guiding one due to the variations in the color tones caused by the printing process.

 -01	Blanco — White	 -39	Aluminio anodizado — Anodized aluminum
 -01T	Blanco texturado — White textured	 -40	Aluminio cepillado — Brushed aluminum
 -02	Negro — Black	 -41	Acero Galvanizado — Galvanized Steel
 -02T	Negro texturado — Black textured	 -43	Inox cepillado — Brushed stainless steel
 -03	Gris — Grey	 -45	Cromado mate — Matt chrome
 -04	Antracita — Anthracite	 -46	Oro mate — Matt gold
 -05	Verde — Green	 -47	Oro — Gold
 -06	Azul — Blue	 -48	Níquel mate — Matt nickel
 -07	Rojo — Red	 -50	Madera Haya — Beech Wood
 -09	Beige — Beige	 -51	Madera Roble — Oak Wood
 -14	Marrón — Brown	 -57	Madera Arce — Maple Wood
 -27	Cristal Opal — Opal Glass	 -58	Ratón Gráfico — Graphite rattan
 -28	Matizado — Frosted	 -59	Madera Nogal — Walnut Wood
 -29	Transparente — Transparent	 -80	Neolith Nero Zimbabwe
 -30	Inox — Stainless steel	 -81	Neolith Phedra Satin
 -32	Cromo — Chrome	 -82	Neolith Iron Moss Satin
 -33	Latón envejecido — Antique brass	 -83	Neolith La Bohème NH
 -34	Latón — Laiton	 -90	Marrón óxido — Oxide brown
 -35	Níquel satinado — Satin nickel	 -91	Marrón cobrizo — Copper brown
 -37	Cobre — Copper	 -92	Cristal transparente — Transparent glass
 -38	Acero cincado — Zinc-plated Steel		

 -BL	Azul claro – Light blue	 -NB	Hormigón antracita – Antracite concrete
 -BR	Bronze – Bronze	 -NN	Hormigón natural – Natural concrete
 -CA	Cotton White	 -NR	Hormigón rojo – Red concrete
 -CB	Cotton Black	 -NW	Hormigón blanco – White concrete
 -CC	Cotton Beige	 -PK	Rosa – Pink
 -CE	Cotton Capuccino	 -RI	Rafia Bali – Bali Raffia
 -CG	Cotton Earth	 -RA	Ribbon wrapped white
 -CJ	Cotton Red	 -RB	Ribbon wrapped Black
 -CK	Cotton Grey	 -RC	Ribbon wapped beige
 -CR	Crema – Cream	 -SA	Synthetic white
 -D1	White synthetic fabric	 -SB	Synthetic black
 -D2	Beige synthetic fabric	 -SC	Lino Marrón – Brown Linen
 -D3	Brown synthetic fabric	 -SG	Synthetic gold
 -D4	Black synthetic fabric	 -SL	Salmón – Salmon
 -DC	Eco Beige	 -SH	Sherry
 -FG	Gris Fourné	 -SM	Synthetic Copper
 -HC	Yute Beige	 -T1	Trama 1 – Pattern 1
 -MI	Mimbre claro – Light wicker	 -W1	Madera oscura – Dark wood
 -M2	Mimbre oscuro – Dark wicker	 -W2	Madera clara – Light wood
 -MK	Moka – Moka	 -W3	Madera natural – Natural wood

ACABADOS ESPECIALES SPECIAL FINISHES



Todos nuestros modelos con acabados en color negro, pueden suministrarse patinados a mano. La uniformidad de esta técnica es aleatoria debido al proceso artesanal y tienen un recargo del 18% y un plazo de entrega máximo de 6 días hábiles posteriores a la entrega standard.

All of our models in black aluminium, polyamide, nylon or glass can be supplied in hand-polished finishes (special finishes). The uniformity of this technique is random due to the manual processes involved. A surcharge of 18% is applicable to these special finishes, and their delivery term is six days.

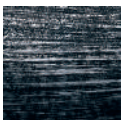

* Negro-plata patinado
Black-silver



* Negro-marrón patinado
Black-brown

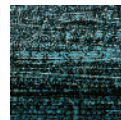

* Negro-verde patinado
Black-green

* Acabado no garantizado por 3 años, ya que se puede deteriorar con el contacto del agua y la radiación solar.

* Finish not guaranteed for 3 years, as it can be deteriorated with contact with water and solar radiation.

MATERIALES — MATERIALS

 Cuerpo – Body
  Marco (Aro) – Frame (Ring)
  Reflector – Reflector
  Difusor – Diffusor

ABS	Plástico ABS	ABS plastic
ACER	Acero	Steel
ALU	Aluminio	Aluminium
ALU ANOD	Aluminio anodizado	Anodized aluminum
ALU FACET	Aluminio facetado	Faceted aluminum
BRASS	Latón	Brass
CERAMIC	Cerámica	Ceramic
COTTON	Algodón	Cotton
CONCRETE	Hormigón	Concrete
Cu	Cobre	Copper
GLASS	Cristal	Glass
GLASS ALABAS	Cristal alabastro	Alabaster glass
GLASS AMBER	Cristal ambar	Amber glass
GLASS FACET	Cristal facetado	Faceted glass
GLASS MAT	Cristal matizado	Frosted glass
GLASS OPAL	Cristal opalizado	Opal glass
GLASS PRISM	Cristal prismático	Prismatic glass
GLASS TRANS	Cristal transparente	Transparent glass
INOX	Acero inoxidable	Stainless steel
LINEN	Lino	Linen
NAT FIBER	Fibra natural	Natural fiber
PA	Poliamida	Polyamide
PC	Polycarbonato	Polycarbonate
PC MAT	Polycarbonato matizado	Frosted polycarbonate
PC OPAL	Polycarbonato opalizado	Opal polycarbonate
PC PRISM	Polycarbonato prismático	Prismatic polycarbonate
PC TRANS	Polycarbonato transparente	Transparent polycarbonate
PE	Poliétileno	Polyethylene
PES	Poliéster	Polyester
PLASTER	Yeso	Plaster
PMMA	Metacrilato	Methacrylate
PMMA FUME	Metacrilato ahumado	Smoked methacrylate
PMMA MAT	Metacrilato matizado	Frosted methacrylate
PMMA OPAL	Metacrilato opalizado	Opal methacrylate
PMMA PRISM	Metacrilato prismático	Prismatic methacrylate
PMMA TRANS	Metacrilato transparente	Transparent methacrylate
PPH	Polipropileno homopolímero	Polypropylene homopolymer
PS	Poliestireno	Polyesthylene
PVC	Policloruro de vinilo	Polyvinylchloride
RAFIA	Rafia	Raffia
RATAN	Ratán	Rattan
RESIN	Resina	Resin
RIBBON WRAPPED	Cinta envuelta	Ribbon wrapped
SILICON	Silicona	Silicone
STONE	Piedra	Stone
SYNT	Sintética	Syntetic
SYNT FIBER	Fibra sintética	Syntetic fiber
TECNO POLIM	Tecnopolímero	Technopolymer
TERMO PLASTIC	Termoplástico	Thermoplastic
WOOD	Madera	Wood
ZAMAK	Aleación Zamak	Zamak Alloy

MATERIALES — MATERIALS

Productos de acero inoxidable

El acero inoxidable es un tipo de acero resistente a la corrosión, dado que el cromo que contiene posee gran afinidad por el oxígeno y reacciona con él formando una capa pasiva de aproximadamente un átomo de grosor, evitando así la corrosión del hierro. Sin embargo, esta capa puede ser afectada por algunos ácidos, dando lugar a que el hierro sea atacado y oxidado por mecanismos intergranulares o picaduras generalizadas.

El acero inoxidable que nosotros normalmente usamos para nuestros productos es el tipo AISI 304, AISI 316 y AISI 316L con un acabado satinado o brillante. Este tipo de acabado garantiza una actuación excelente por lo que se refiere a la durabilidad, fuerza, además de su fácil limpieza.

Sobre el acero inoxidable pueden aparecer pequeñas manchas como resultado del contacto con la atmósfera marina, ambientes húmedos, así como la cal proveniente de los riegos. Este tipo de contaminación sobre el acero inoxidable se eliminará con la aplicación de productos limpiadores que contengan ácido fosfórico.

Productos en aluminio

El aluminio es un elemento químico, de símbolo Al y número atómico 13. Se trata de un metal no ferroso. Es el tercer elemento más común encontrado en la corteza terrestre. Los compuestos de aluminio forman el 8% de la corteza de la tierra y se encuentran presentes en la mayoría de las rocas, de la vegetación y de los animales. En estado natural se encuentra en muchos silicatos (feldespatos, plagioclasas y micas). Como metal se extrae del mineral conocido con el nombre de bauxita, por transformación primero en alúmina mediante el proceso Bayer y a continuación en aluminio mediante electrólisis. Nuestros artículos han sido protegidos con cromatización y acabados con pinturas de poliéster y su deterioro puede producirse por: **1.** Contacto continuado con aguas de alto porcentaje de sal o aguas ácidas contaminadas por abonos o insecticidas. / **2.** La electrólisis producida por el contacto del aluminio con los tornillos de sujeción si son de acero (se aconsejan de acero inoxidable). / **3.** La corriente vagante existente en el terreno, únicamente evitable con una correcta toma-tierra. / **4.** La no protección rápida del aluminio en el caso de verse arrancada la pintura por roce o golpe.

Productos poliamida

Una poliamida es un tipo de polímero que contiene enlaces de tipo amida. Las poliamidas se pueden encontrar en la naturaleza, como la lana o la seda, y también ser sintéticas, como el nylon o el Kevlar. La poliamida, de uso cada vez más frecuente en la industria, agrupa materiales como el Policarbonato, Polivinilo o el Nylon. Todos ellos con unas características comunes: su difícil destrucción y su larga duración. Considerado uno de los materiales más adecuados en productos expuestos a temperaturas extremas, a la humedad, al salitre del mar, a los rayos UV y a los fertilizantes químicos. La composición de los materiales poliamida, son garantía de una larga duración, tanto en zonas secas como húmedas. Su deterioro puede producirse por: **1.** Maltrato o fuerte impacto. / **2.** Aproximación a espacios de alta temperatura. / **3.** Contacto con productos químicos de mucha acidez.

Stainless steel products



Stainless steel is a type of steel resistant to corrosion, since the chromium it contains has a great affinity for oxygen and reacts with it to form a passive layer approximately one atom thick, thus preventing the corrosion of iron. However, this layer can be affected by some acids, leading to the iron being attacked and oxidized by intergranular mechanisms or generalized pitting.

The stainless steel that we normally use for our products is AISI 304, AISI 316 and AISI 316L with a satin or bright finish. This type of finish guarantees excellent performance in terms of durability, strength, as well as easy cleaning.

Small stains may appear on stainless steel as a result of contact with the marine atmosphere, humid environments, as well as lime from irrigation. This type of contamination on stainless steel will be eliminated with the application of cleaning products that contain phosphoric acid.

Aluminium products



Aluminum is a chemical element, with the symbol Al and atomic number 13. It is a non-ferrous metal. It is the third most common element found in the earth's cortex. Aluminum compounds make up 8% of the earth's cortex and they are present in most rocks, vegetation, and animals. In its natural state it is found in many silicates (feldspars, plagioclase and micas). As a metal, it is extracted from the mineral known as bauxite, by transformation first into alumina through the Bayer process and then into aluminum through electrolysis. Our articles have been protected with chromatinization and finished with polyester paints and their deterioration can be caused by: **1.** Continuous contact with waters with a high percentage of salt or acid waters contaminated by fertilizers or insecticides. / **2.** The electrolysis produced by the contact of the aluminum with the fixing screws if they are made of steel (stainless steel is recommended). / **3.** The existing wandering current in the land, avoidable only with a correct grounding. / **4.** The non-rapid protection of the aluminum in the event of the paint being torn off by rubbing or hitting.

Produits en polyamide



A polyamide is a type of polymer that contains amide-type linkages. Polyamides can be found in nature, like wool or silk, and can also be synthetic, like nylon or Kevlar. Polyamide, increasingly used in industry, groups materials such as Polycarbonate, Polyvinyl or Nylon. All of them with some common characteristics: its difficult destruction and its long duration. Considered one of the most suitable materials in products exposed to extreme temperatures, humidity, sea salt, UV rays and chemical fertilizers. The composition of the polyamide materials is a guarantee of a long life, both in dry and humid areas. Its deterioration can be caused by: **1.** Mistreatment or strong impact. / **2.** Approach to high temperature spaces. / **3.** Contact with highly acidic chemicals.

MATERIALES — MATERIALS

Productos de resina

Resin products



Las luminarias fabricadas con resina destacan por estas cualidades: **1.** Protegidas contra la corrosión química en un amplio rango de ácidos, bases, cloruros, sales y solventes orgánicos. / **2.** Protegidas contra el impacto en la pintura de los rayos UV. / **3.** Excelente comportamiento en aislamiento térmico y eléctrico (doble aislamiento). / **4.** Sobresaliente resistencia al impacto y a la fatiga. / **5.** Fabricadas con materiales ignífugos. **6.** Ligeras y fáciles de transportar. **7.** Mantenimiento mínimo: precisa de mantenimiento periódico con aceite sintético para recuperar el brillo.

Luminaires made of resin stand out for these qualities:

1. Protected against chemical corrosion in a wide range of acids, bases, chlorides, salts and organic solvents. / **2.** Protected against the impact of UV rays on the paint. / **3.** Excellent behavior in thermal and electrical insulation (double insulation). / **4.** Outstanding resistance to impact and fatigue. **5.** Made with fireproof materials. / **6.** Light and easy to transport. / **7.** Minimal maintenance: requires periodic maintenance with synthetic oil to restore shine.

Composición de nuestras columnas de resina — Composition of our resin posts

1. Resina exterior: poste de una sola pieza, resistente a golpes, UV, ignífugo y sin agentes corrosivos. — 1. Outdoor resin: one-piece post, shock-resistant, UV-protected, fireproof, and free of corrosive agents.



2. Relleno de poliuretano expandido
2. Expanded polyurethane filling

3. Estructura de acero galvanizado Mediante inmersión en bañera de zinc.
3. Steel structure galvanised By means of zinc bath immersion.

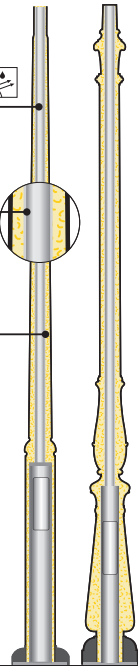

CONSEJOS USO E INSTALACIÓN

USAGE AND INSTALLATION TIPS

Empotrables de suelo y balizas

Floor recessed and bollards



En instalaciones de luminarias empotradas, deberán ser realizadas por personal cualificado, teniendo la máxima precaución y de acuerdo con las instrucciones de montaje adjuntadas con el producto y conforme a las normas de instalación electrónica de la normativa vigente. Para tener en cuenta en este tipo de instalaciones: **1.** Evite colocar las luminarias en vaguadas o depresiones del terreno. **/ 2.** Es indispensable realizar un drenaje para todos los aparatos (arena de gravilla de 25 a 30 mm) con el objetivo de evitar el estancamiento de agua en el fondo del surco donde se instalan los aparatos. Un drenaje correcto debe permitir la absorción de 5 litros de agua en 8 minutos. **/ 3.** En lo referente a los aparatos encastrados en cemento u hormigón y habida cuenta de la tendencia de estos materiales a sufrir dilatación o compresión debido a los cambios de temperatura, es preciso prever un recubrimiento de dilatación y asegurarse de que el surco esté nivelado con el pavimento. **/ 4.** La conexión entre los aparatos debe efectuarse mediante cable flexible tipo H05RN-F o H07RN-F con el fin de facilitar su mantenimiento y evitar los esfuerzos sobre los pasacables durante la instalación. Se tiene que evitar la instalación de varios cables por una sola salida o la instalación con cables unipolares. Al igual que se recomienda la utilización de conectores estancos en instalaciones soterradas con el fin de evitar posibles daños por humedad.

Para conservar balizas/postes, instáloslos sobre una pilastra elevada, nunca a nivel del suelo, tierra o césped. Los cambios de presión por condiciones ambientales y altitud pueden ser causados por el calor al encender y enfriar la luminaria o por golpes térmicos de lluvia, nieve o lavado.

Para reducir la condensación en aparatos con alto IP, opere la luminaria 1 hora sin el cristal de protección y luego ciérrela de inmediato. Las decisiones técnicas deben ser tomadas por el responsable del departamento técnico, limitando sugerencias externas.

For recessed lighting installations, they must be carried out by qualified personnel, with the utmost caution and in accordance with the assembly instructions provided with the product and in compliance with the current electrical installation regulations. Points to consider for such installations: **1.** Avoid placing the lights in dips or depressions in the ground. **/ 2.** It is essential to ensure effective drainage for all fixtures (gravel sand of 25 to 30 mm) to prevent water from pooling at the bottom of the trench where the fixtures are installed. Proper drainage should absorb 5 liters of water in 8 minutes. **/ 3.** For fixtures embedded in concrete or cement, considering the tendency of these materials to expand or contract due to temperature changes, a dilation covering must be provided, and the trench must be level with the pavement. **/ 4.** The connection between fixtures should be made using flexible cable type H05RN-F or H07RN-F to facilitate maintenance and avoid stress on cable glands during installation. Avoid installing multiple cables through a single outlet or using single-core cables. It is also recommended to use waterproof connectors in buried installations to prevent potential damage from moisture.

To preserve bollards/poles, install them on an elevated pedestal, never at ground level, on soil or grass. Pressure changes due to environmental conditions and altitude can be caused by heat from turning the light on and off or by thermal shocks from rain, snow, or washing.

To reduce condensation in high IP-rated fixtures, operate the light for 1 hour without the protective glass, then close it immediately. Technical decisions should be made by the technical department head, limiting external suggestions.

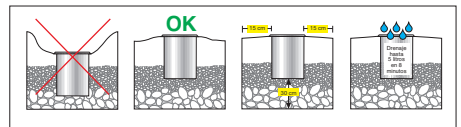

En el cambio de las lámparas y antes de cerrar las luminarias se debe limpiar las juntas para evitar que se depositen restos de tierra y/o hierba. — When changing the lamps, the joints should be cleaned prior to closing the luminaire to avoid the accumulation of earth and/or grass.

No instalar más de un cable por cada salida. Instalar sobre una pilastra a un nivel superior. — Do not install more than one cable in each outlet. Install on a plinth at a higher level.

CONSEJOS USO E INSTALACIÓN TIRAS LED

1. NO doblar la tira u otros componentes ya que podría dañar el conexionado. (1) / NO tocar ni ejercer presión sobre los LEDS durante la instalación. (2)

2. NO conecte directamente la tira de LED a la red eléctrica. Sólo debe conectarse a un controlador adecuado de 24V.

3. Evitar ubicar las tiras en zonas con temperatura elevada o luz directa del sol. Se recomienda el uso de perfiles de aluminio para reducir la temperatura de trabajo. (Imprescindible para tiras de más de 5W/m).

4. Los productos pueden dañarse por descarga electrostática (ESD). La puesta a tierra evita los efectos dañinos de la ESD. Durante el montaje, use un sistema de puesta a tierra personal para evitar la acumulación de carga estática.

5. Dependiendo de la superficie, utilice un limpiador multiuso (por ejemplo, alcohol isopropílico) para proporcionar una superficie de montaje limpia y seca, libre de aceites, revestimientos antiadherentes y partículas de suciedad.

6. Si el producto necesita ser cortado a medida; por favor mida cuidadosamente y corte en ángulo recto las marcas de corte señaladas usando solamente unas tijeras afiladas.

USAGE AND INSTALLATION TIPS LED STRIPS

1. DO NOT touch or press the LED strips or other components during the installation. (1) / DO NOT twist or bend the LED strip, or connection may be damaged. (2)

2. DO NOT connect the LED strip directly to mains supply. It must only be connected to a suitable 24V LED driver.

3. Avoid placing the strips in areas with high temperature or direct sunlight. We recommend the use of aluminum profile to reduce the temperature. (Required for more than 5W/m strips).

4. Products can be damaged by electrostatic discharge (ESD). Grounding prevents the harmful effects of ESD. During assembly, use a personal grounding system to avoid static charge buildup.

5. Depending on the surface, use a multi-purpose cleaner (e.g. isopropyl alcohol) to provide a clean and dry mounting surface which is free of oils, release coatings and dirt particles.

6. If the product needs to be custom cut; please measure carefully and cut at right angle by the appropriate cut marks by using a sharp scissors.

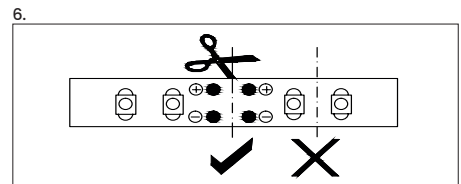
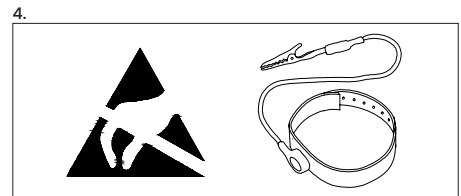
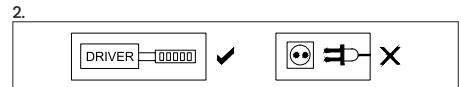
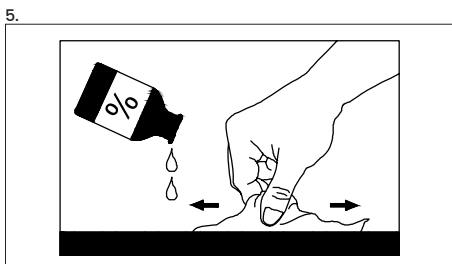
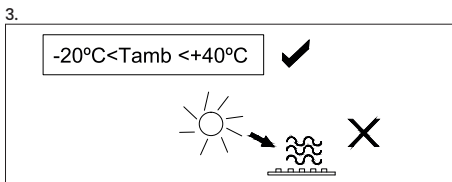
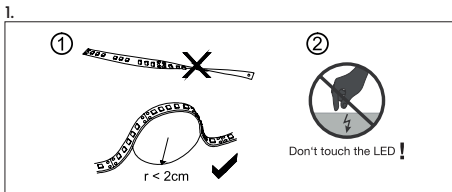

CONSEJOS USO E INSTALACIÓN TIRAS LED

La máxima distancia posible del convertidor a las tiras vendrá dada por la sección del cable utilizado. No se debe exceder la caída de tensión de 2V en el conductor entre la tira o tiras en el convertidor. La sección (S) en mm² del cable necesario viene determinado por la siguiente fórmula, siendo:

- "r" la resistividad (Cu = 0,017)
- "L" la longitud en metros de la línea
- "I" la intensidad en Amperios
- "V" la caída de tensión máxima admisible

Los convertidores deben contemplar las pérdidas en la distribución, es aconsejable sobredimensionar la potencia de éstos en un 20% para cubrir estas pérdidas.

USAGE AND INSTALLATION TIPS LED STRIPS

The longest distance from the converter to the strips will be given by the section of the cable to be used. The 2V voltage drop in the conductor between the strip(s) and the converter should not be exceeded. The section (S) in mm² of the required cable is determined by the following formula, they are:

- "r" the resistivity (Cu = 0,017)
- "L" Line length in meters
- "I" Intensity in amps
- "V" the maximum allowable voltage drop

The converters must consider the losses in the distribution, it is advisable to oversize their power by 20% to cover these losses.

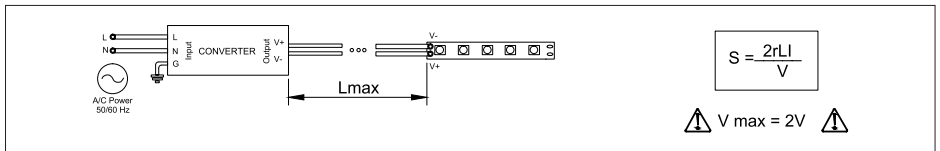

PICTOGRAFÍA — SYMBOLOGY

ICONOGRAFÍA GENÉRICA	GENERIC ICONOGRAPHY
N Novedad	New
E Extensión de gama	Range extension
U Actualización de producto	Product update

APLICACIONES	APPLICATIONS
 Luminaria para superficie en pared	Wall-mounted luminaire
 Luminaria para superficie en techo	Ceiling surface-mounted luminaire
 Luminaria para superficie en suelo	Ceiling floor luminaire
 Luminaria para empotrar en pared	Recessed wall luminaire
 Luminaria para empotrar en techo	Recessed ceiling luminaire
 Luminaria para empotrar en suelo	Recessed floor luminaire
 Luminaria de suspensión	Pendant luminaire
 Luminaria de pie	Floor lamps
 Luminaria de sobremesa	Table lamps
 Baliza o luminaria de sobremuro	Bollard or wall-top luminaire
 Luminaria de columna	Column Luminaire
 Proyector de pared	Spotlight for wall
 Proyector de suelo	Spotlight for floor
 Proyector de techo	Ceiling projector
 Proyector para empotrar	Recessed projector
 Luminaria de suspensión para carril	Pendant luminaire for track
 Proyector para carril	Projector for track
 Ventilador con luz.	Fan with lamp.
 Ventilador	Fan
 Proyector sumergible	Underwater lights
 Luminaria sumergible para superficie en pared	Ceiling wall underwater luminaire
 Luminaria sumergible para empotrar en pared	Recessed wall underwater luminaire







PICTOGRAFÍA — SYMBOLOGY

ICONOGRAFIA TÉCNICA

TECHNICAL ICONOGRAPHY

Alimentación

Power supply

	Luminaria con alimentación solar	Solar-powered luminaire
	Corriente de la luminaria en corriente continua	Luminaire current in direct current
	Voltaje de la luminaria en corriente continua	DC voltage of the luminaire
	Voltaje de la luminaria en corriente alterna	AC voltage of the luminaire
	Frecuencia	Frequency
	Motor con corriente alterna	Alternate current motor
	Motor con corriente continua	Direct current motor





Equipo

Equipment

	Equipo electrónico incluido / NO incluido	Luminaire with electronic equipment included /not included
---	---	--

Dimerización

Dimerization

	Regulación por Corte al final de fase	Trailing Edge dimming
	Regulación por Corte en inicio y/o final de fase	Dimmable Trailing and Leading Edge dimming
	Regulable mediante protocolo DMX	Dimmable by DMX protocol
	Regulable mediante protocolo DMX-RDM	Dimmable by DMX-RDM protocol
	Regulable mediante pulsador	Dimmable by push
	Regulable mediante protocolo 1-10V	Dimmable by 1-10V protocol

 Aplicación que permite a los usuarios conectar y gestionar dispositivos inteligentes en sus hogares. Application that allows users to connect and manage smart devices in their homes.



 Control de iluminación inalámbrico CASAMBI CASAMBI wireless lighting control

 Regulable mediante protocolo DALI Dimmable by DALI protocol

 La función MidNight regula la luz automáticamente sin control externo, permitiendo ajustar los niveles de salida según el horario o un reloj astronómico. The MidNight function automatically regulates the light without external control, allowing output levels to be adjusted based on a schedule or an astronomical clock.

Clase

Class

	Clase I; Luminaria provista de dispositivos de toma-tierra	Class I; luminaire fitted with earth-ground devices
	Clase II; Luminaria que aísla doblemente las partes con tensión y no precisa dispositivos de toma-tierra	Class II; luminaire that doubly insulates the electrified parts and does not require an earth-ground device
	Clase III; Luminaria alimentada a muy baja tensión y que no debe tener dispositivos toma-tierra	Class III; luminaire with very low voltage power supply which does not require earth-ground devices.

PICTOGRAFÍA — SYMBOLOGY

Grado de protección IP



Según la normativa EN 60598-1, las luminarias se clasifican en función de la protección derivada de sus elementos conliza mediante las letras IP seguidas de tres cifras, aunque sólo se muestren las dos primeras.

1ª cifra: Indica la protección del material contra el ingreso de objetos sólidos externos, así como de las personas respecto a la tensión de los componentes de la luminaria.

- 0- No protegido
- 1- > 50 mm diámetro
- 2- > 12,5 mm diámetro
- 3- > 2,5 mm diámetro
- 4- > 1,0 mm diámetro
- 5- Polvo-protegido
- 6- Hermético al polvo

2ª cifra: Indica la protección contra el ingreso de agua con efectos perjudiciales

- 0- (no-protegida)
- 1- Goteando verticalmente
- 2- Goteando (inclinado 15°)
- 3- Rociando
- 4- Salpicando
- 5- Chorreado
- 6- Chorro de gran alcance
- 7- Inmersión transitoria
- 8- Inmersión continua

Degree of IP protection

In accordance with standard EN 60598-1, luminaires are classified on the basis of the protection derived from their elements of construction. The degree of protection is indicated by the letters IP followed by a 3-figure number, though only the first two numbers are shown.

1st figure: Indicates the protection of the material against ingress of solid foreign objects, as well of people coming into contact with live parts in the device.

- 0- Not Protected.
- 1- > 50 mm diameter
- 2- > 12,5 mm diameter
- 3- > 2,5 mm diameter
- 4- > 1,0 mm diameter
- 5- Dust protected
- 6- Dust tight

2nd figure: Indicates the protection of the material against ingress of water with harmful effects

- 0- Not Protected.
- 1- Vertically dripping
- 2- Dripping (15° tilted)
- 3- Spraying
- 4- Splashing
- 5- Jetting
- 6- Powerful jetting
- 7- Temporary immersion
- 8- Continuous immersion

Grado de protección IK



Código IK
Sistema de codificación para indicar el grado de protección proporcionado por una envolvente contra los impactos mecánicos nocivos.
Energía de impacto (J)

IK01	IK02	IK03	IK04	IK05	IK06	IK07	IK08	IK09	IK10
0,15	0,2	0,35	0,5	0,7	1	2	5	10	20

Degree of IK protection

IK Code
The IK code is an international numerical classification for the degree of protection provided by enclosures for electrical equipment against external mechanical impact. Impact energy (J)

Vida



Vida útil (horas)

Life

Life (hours)



Mantenimiento del flujo luminoso LED

LED luminous flux maintenance



Luminaria recargable

Rechargeable luminaire



Autonomía de la batería (horas)









Battery Autonomy (hours)



Tiempo de carga completa (horas)

Charge Time (hours)

PICTOGRAFÍA — SYMBOLOGY



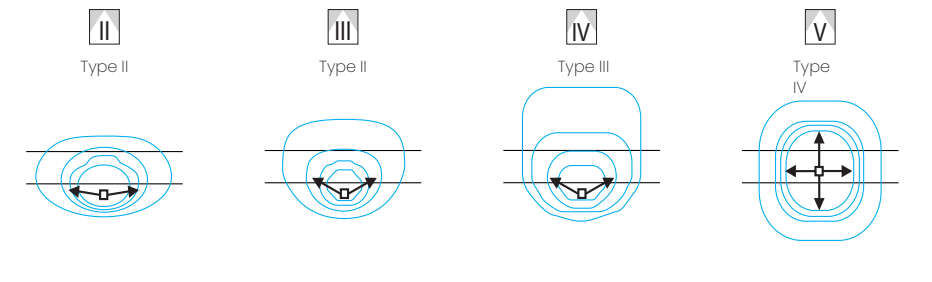

Haz de luz	Light beam
 Emisión de luz directa o indirecta	Emission of direct or indirect light
 Emisión de luz directa y indirecta	Emission of direct and indirect light
 Emisión de luz periférica	Periferic emission light
 Emisión de luz asimétrica	Asymmetric light emission
 Multi-emisión de luz	Multi-emission light
 Ángulo de emisión de luz	Light emission angle
 Flujo hacia el hemisferio superior	Upward light ratio
 Índice de deslumbramiento unificado	Unified glare rating

Tipos de distribución luminica para iluminación exterior Lighting Distribution Types for Outdoor Area Light





















CRI	CRI
 Índice de reproducción cromática	Color rendering index









Step	Step
 Consistencia del color	Color consistency



Resistencia	Resistance
 Luminaria adaptada para tránsito no rodado	Luminaire adapted for non-vehicular traffic
 Luminaria adaptada para tránsito rodado	Luminaire adapted for vehicular traffic
 Luminaria con una excelente resistencia a la corrosión (aluminio con doble recubrimiento de pintura, acero con proceso de galvanizado, resina o poliamida)	Luminaire with excellent resistance to corrosion (aluminum with double painting process, steel galvanizing process, resin or polyamide)
 Temperatura máxima de la superficie de la luminaria (°C)	Maximum temperature (°C) of the glass surface at an average room temperature
 Luminarias con alta resistencia a los rayos Ultra Violeta para evitar que el color se deteriore	luminaires with high resistance to Ultra-Violet rays to prevent color deterioration

PICTOGRAFÍA — SYMBOLOGY





Funcionalidades	Features
 K SELECT	Luminaria con opción de seleccionar la temperatura de color Light fixture with option to select the color temperature
 W SELECT	Luminaria con opción de seleccionar la potencia. Light fixture with option to select the power
	Dimerable Dimmable
	Ángulo máximo de basculación de la luminaria Maximum angle of tilting of the lamp.
	Ángulo de rotación máximo Maximum angle of rotation
	Luminaria con sensor de Movimiento Luminaire with sensor motion detection
	Luminaria con sensor Crepuscular Luminaire with twilight sensor
	Luminaria con sensor Crepuscular Subordinado a la Detección de Movimiento Luminaire with twilight sensor subordinated to motion detection
	Luminaria con luz de emergencia Luminaire with emergency light
	Luminaria con conexión USB (5V max 2A) Luminaire with USB port (5V max. 2A)
	Función inversa para usarlo todo el año Inverse function to use it the whole year





Equipamiento para instalación	Installation equipment
	Luminaria con una salida de cable Luminaire with one cable outlets
	Luminaria con dos salidas de cable Luminaire with two cable outlets
	Longitud en metros de cable conductor suministrado Longueur en mètres du câble conducteur fourni
	Luminaria con cable clavija incorporada Lighting with plug-electrical wire Included
	Luminaria con toma corriente IP44 Luminaire with IP44 plug
	Luminaria con interruptor Incorporado Lighting with switch Included
	Número de aspas del ventilador Number of fan blades.



Características de instalación	Installation features
	Medidas de empotramiento (mm) Recess dimensions (mm)
	Caja de empotrar Incluida Recessing box Included
	Precisa drenaje Requires drainage
	Anclaje Incluido Anchorage Included
	Instalar sobre una pilastra a un nivel superior Install on a plinth at a higher level
	No utilizar atornilladores mecánicos Never use mechanical screwdrivers
	Adecuado al lado del mar Sea side suitable
	Resistencia a la sal y la corrosión hasta 1000 horas Salt and corrosion resistance up to 1000 hours
	Resistencia a la sal y la corrosión hasta 500 horas Salt and corrosion resistance up to 500 hours





Clásico	Classic
	Globo con cierre bayoneta Globe with bayonet fitting
	Globo con cierre hermético Hermetically sealed globe
	Poste con registro Post with inspection chamber





PICTOGRAFÍA — SYMBOLOGY

Mantenimiento	Maintenance
 Luminaria de acero inoxidable que precisa de un mantenimiento periódico	Stainless steel luminaire which requires periodical maintenance
 Luminaria de latón que precisa de mantenimiento periódico con pulimento específico para recuperar el brillo	Brass luminaires require a periodic maintenance with specific polishing to restore the brightness
 Luminaria o poste de resina que precisa de mantenimiento periódico con aceite sintético para recuperar el brillo	Resin luminaries or posts that require a periodic maintenance with synthetic oil to restore the brightness
 Luminaria de acero inoxidable que precisa de un mantenimiento periódico	Stainless steel luminaire which requires periodical maintenance
 Posibilidad de aplicar acabados especiales	Possibility of special finishings

Tiras LED	LED Stripes
 Longitud de la tira led (mínima unidad de venta)	Standard length (Minimum Order)
 Tramo mínimo de corte	Minimum cutting section
 Incorpora cinta autoadhesiva 3M en el dorso	Includes 3M self-adhesive tape on the back
 Conectar a red Wifi de banda 2,4 GHz	Connect to a 2.4 GHz Wi-Fi network

Sumergibles	Waterproof
 No apto para piscinas	Not suitable for swimming pool
 Número de colores	Number of colors
 Número de secuencias de cambio de color	Number of color change sequences

Accesorios	Accessories
 Luminaria con lámpara Incluida	Luminaire with lamp included
 Luminaria con lámpara NO Incluida	Luminaire with lamp NOT included
 Pantalla incluida	Shade included
 Incluye mando a distancia	Include remote control
 Carga inalámbrica para dispositivos móviles	Wireless charging for mobile devices
 Luminaria con packaging corporativo	Luminaire with corporate packaging

Filtros	Filters
 Verdura	Vegetables
 Pescado	Fish
 Marisco	Seafood
 Pan	Bread
 Carne	Meat
 Fashion	Fashion

NOVOLUX LIGHTING S.L. se reserva el derecho a realizar las variaciones que considere oportunas a sus productos no siendo responsable de la posible información errada que aparezca en dicho catálogo.

Todas las solicitudes realizadas a Novolux Lighting, S.L. (en adelante, 'NOVOLUX') suponen la aceptación plena e incondicional por parte del comprador de las presentes Condiciones Generales de Venta, salvo que existan acuerdos de colaboración o condiciones particulares previamente pactadas.

1. Precios

- Todos los pedidos, ya sean de **Oferta Comercial Estándar o Bajo Pedido (referencias incluidas en catálogo)**, estarán sujetos a las tarifas y condiciones comerciales vigentes en la fecha de recepción del pedido.
- Para pedidos de servicios **Ejecuciones Especiales (sin referencias en catálogo)**, será imprescindible la presentación de una oferta por escrito por parte de NOVOLUX, junto con el compromiso de aceptación por parte del cliente. Estos pedidos no tendrán opción de devolución/cancelación una vez iniciado el proceso de fabricación.
- Únicamente serán válidos los **precios especiales reflejados en las ofertas** por escrito, siempre y cuando el pedido se realice en su totalidad conforme a dicha oferta. Cualquier modificación por parte del cliente sobre la oferta original íntegra podrá implicar una revisión de las condiciones iniciales de la venta.

2. Gestión de Pedidos

- Un pedido no se considerará recibido de manera efectiva hasta que todos sus elementos (referencias, color, accesorios, P.V.P., etc.) hayan sido correctamente especificados.
- La formalización de un pedido a NOVOLUX expresará la voluntad de compra del cliente. En caso de que no sea posible atender el pedido por cualquier motivo, NOVOLUX informará al cliente de dicha circunstancia a la mayor brevedad posible. Los pedidos que contengan precios incorrectos o discrepancias con las condiciones registradas y/o acordadas con NOVOLUX no serán procesados hasta obtener una confirmación por escrito de ambas partes. NOVOLUX solicitará esta confirmación y aceptación a través del correo electrónico especificado en el pedido enviado por el cliente.
- Todo pedido que incluya referencias que impliquen Ejecuciones Especiales y/o Bajo Pedido requerirá la aceptación previa de NOVOLUX, confirmando la viabilidad de producción, precio y plazo de entrega antes de su procesamiento. NOVOLUX exigirá un anticipo no inferior al 30% del valor total del pedido (incluyendo impuestos).
- Para todos los pedidos inferiores a **100€** con destino en la zona del Barcelonés y sus centros logísticos en Barcelona provincia, se aplicará un cargo de transporte. Para pedidos que superen este importe, los costos de envío serán asumidos por NOVOLUX.
- Los pedidos recibidos, salvo que se indique lo contrario, podrán ser entregados parcialmente en caso de que no haya disponibilidad de stock para la totalidad de los artículos solicitados. En tal caso, los gastos de envío mantendrán las mismas condiciones que el pedido original, y el resto de los artículos pendientes será enviado con portes pagados si el pedido original cumplía con dicha condición.
- Para aquellos pedidos en los que no se especifique de manera expresa un plazo de entrega, se gestionarán conforme al punto anterior. Si el cumplimiento del plazo de entrega total o parcial es un requisito indispensable para el cliente, este deberá solicitarlo por escrito a NOVOLUX.
- **No se aceptarán o tramitarán** pedidos inferiores a **100€ netos**. Sujeto a condiciones comerciales autorizadas por dirección. Tendrán un cargo por gestión de **15€**, además del cargo por transporte.
- Las condiciones a portes pagados serán todos aquellos pedidos que superen; en **Península** a partir de **600€** netos, **Portugal** a partir de **400€** netos y en **Canarias** serán de **1000€** netos, excepto pedidos sujetos a verificación comercial por su gran volumen (consultar condiciones).

3. Política de Devoluciones

- No está permitida ninguna devolución sin la autorización previa de NOVOLUX. Para proceder, el cliente debe proporcionar el número de autorización asignado previamente por el Departamento de Incidencias (incidencias@novoluxlighting.com). Cualquier devolución que no incluya dicho número será rechazada en nuestras instalaciones.
- No se aceptarán devoluciones de productos fabricados bajo ejecuciones especiales, por pedido específico o descatalogados, incluso si el cliente propone una depreciación. Los productos para devolver deben haber sido facturados en un plazo no mayor a 60 días desde la fecha de venta. De no cumplir con esta condición, NOVOLUX se reserva el derecho de rechazar la solicitud de devolución.
- Los productos devueltos deben estar en perfectas condiciones, incluyendo su embalaje original. En caso contrario, si el cliente solicita la devolución del material rechazado, el envío correrá a su cargo (portes debidos).
- Una vez autorizada la devolución, el material debe ser enviado a NOVOLUX en un plazo máximo de 30 días.
- A toda devolución autorizada se le aplicará la siguiente depreciación sin excepción:
 - Para solicitudes dentro de los primeros 30 días desde la fecha de factura: se aplicará una depreciación del 15% sobre el valor de la devolución, con un cargo mínimo de 30€ por gestión administrativa.
- No se aceptará ningún envío de devolución que llegue a portes debidos.
- Si se recibe material no autorizado, en mal estado o sin cumplir con las condiciones establecidas, se notificará al cliente que debe retirar el producto de las instalaciones de NOVOLUX en un plazo máximo de 15 días desde la notificación. Pasado este plazo, el material se considerará abandonado y será destruido, sin responsabilidad para NOVOLUX.

4. Entregas y Transporte

- Para envíos internacionales, los mercancías viajarán bajo la responsabilidad y riesgo del comprador, en condiciones **EXW (Ex Works)**, salvo que se acuerden otros términos entre ambas partes.
- Los importes de transporte se establecerán según la zona de venta correspondiente (consulte las tarifas de su zona). El servicio será a portes pagados y dichos costes se reflejarán en la factura.
- Cualquier incidencia, rotura o falta de material deberá constar explícitamente en el albarán de entrega del transportista. La falta de esta información exime de toda responsabilidad tanto al transportista como a NOVOLUX.
- No se aceptarán reclamaciones por roturas o incidencias relacionadas con el transporte después de **5 días naturales** desde la recepción de la mercancía.
- NOVOLUX solo asumirá la responsabilidad por incidencias en la entrega cuando el envío se haya contratado a cargo de NOVOLUX.
- Los riesgos relacionados con la devolución de mercancías no autorizadas por NOVOLUX serán siempre asumidos por el comprador.

5. Plazos de Disponibilidad (EXW - Franco Fábrica)

- Los plazos de disponibilidad proporcionados por NOVOLUX son siempre aproximados y pueden estar sujetos a variaciones derivadas de los propios procesos de gestión de pedidos, producción o de factores externos, como el transporte de mercancías y el suministro de componentes por terceros.
- Cualquier variación en los plazos de entrega no implicará, en ningún caso, la aceptación de responsabilidad ni la aplicación de penalizaciones por demora por parte de NOVOLUX.

6. Servicio Especial CRISTHER en 1 Hora

- (Incluye todas las marcas: CRISTHER, DOPO, EXO, INDELUX)
- Nuestro servicio especial garantiza la preparación del pedido y su disponibilidad para el transitario o transportista designado en un plazo de 1 hora.
- Este servicio conlleva un recargo del 6% sobre los artículos solicitados.
- Los plazos de transporte no son responsabilidad de NOVOLUX.

7. Proyectos de Iluminación

- Como servicio adicional para nuestros clientes, ponemos a su disposición nuestro propio **Departamento Técnico de Proyectos**, especializado en asesoramiento para cualquier necesidad lumínica, tanto de interior como de exterior.
- El nivel de prestación de nuestros servicios se ajusta a las particularidades de cada proyecto. Nos reservamos el derecho de aplicar un coste en aquellos proyectos de especial relevancia, que podrá ser bonificado en el pedido final de compra del material.

8. Muestras

- Las muestras de material deberán ser solicitadas a través de un pedido formal y serán facturadas.
- El plazo máximo para la devolución de las muestras a NOVOLUX es de **60 días** desde la fecha de entrega, y su devolución deberá realizarse a portes pagados por el cliente.
- No se aceptarán muestras devueltas que no se encuentren en condiciones óptimas para la venta, es decir, en perfecto estado y con su embalaje original.

9. Calidad

- Los productos suministrados por NOVOLUX cumplen con la Directiva RoHS 2011/65/UE y con la Directiva 2014/35/UE, según lo establecido en la normativa europea. Esta conformidad está claramente indicada tanto en el producto como en su embalaje exterior. Además, todos los productos han pasado rigurosos controles de calidad que garantizan su correcto funcionamiento.
- En NOVOLUX trabajamos con un enfoque de mejora continua, adaptando nuestros productos al mercado actual y cumpliendo con las normativas vigentes.
- Por lo tanto, nos reservamos el derecho de modificar, suprimir o ampliar nuestro catálogo de productos sin previo aviso, sin que ello pueda ser motivo de reclamaciones.
- Para asegurar la máxima durabilidad y rendimiento de los productos, NOVOLUX recomienda seguir las instrucciones adjuntas y realizar el mantenimiento adecuado con la periodicidad recomendada, teniendo en cuenta los materiales de fabricación.

10. Garantía

- Todos los productos de NOVOLUX cuentan con un periodo de garantía de 3 años a partir de la fecha de factura emitida por NOVOLUX.
- Bajo solicitud, se podrá evaluar una extensión de la garantía o la posibilidad de ofrecer una garantía personalizada para proyectos, según las condiciones específicas de aplicación.
- Cualquier reparación realizada por técnicos de NOVOLUX tendrá una garantía adicional de 6 meses sobre la pieza reparada o sustituida.
- En el caso de las lámparas, se garantiza un periodo de 6 meses, al ser consideradas consumibles, siempre y cuando se cumplan las siguientes condiciones de uso:
 - Temperatura ambiente entre -10°C y +40°C.
 - Al menos 10 mm de espacio libre alrededor del cuerpo de la lámpara.
 - La instalación eléctrica no debe estar sujeta a fluctuaciones de tensión que superen el rango nominal de la red de +/- 10%.
 - Un máximo de 50,000 conmutaciones rápidas (intervalo entre encendido y apagado inferior a 30 segundos).
- Si no se cumplen estas condiciones, se aplicará la garantía legal de 6 meses por defectos de fabricación.
- El Departamento Técnico de NOVOLUX es el único autorizado para determinar, tras un análisis, si un producto presenta un defecto de fabricación. Para ello, es necesario que el cliente envíe por escrito la incidencia, acompañada de fotografías del equipo y su ubicación, junto con la factura de compra para verificar la fecha de venta.
- La responsabilidad de NOVOLUX se limita a la sustitución del producto defectuoso por el mismo modelo o uno similar, o al reembolso de su valor si el modelo ya no se fabrica o no está disponible. No se asumirá ninguna otra responsabilidad adicional bajo ningún concepto, salvo la establecida en esta garantía.

- NOVOLUX no se hará cargo de los costes de mano de obra para la sustitución o renovación de los materiales cubiertos por la garantía, una condición que se acepta al momento de la compra de nuestros productos.
- NOVOLUX no asume responsabilidad por el uso indebido o la incorrecta aplicación de sus productos. La garantía se invalidará en caso de manipulación inadecuada o instalación incorrecta. Quedan excluidos de la garantía los defectos y daños ocasionados por desgaste normal, causas de fuerza mayor, mantenimiento deficiente o uso inadecuado del producto que no esté especificado ni autorizado por el vendedor.
- Las intervenciones realizadas en virtud de la garantía no extenderán la duración de la misma.

Garantía de Productos – NOVOLUX LIGHTING

En cumplimiento con la Ley para la Defensa de los Consumidores, NOVOLUX LIGHTING garantiza que los productos adquiridos están protegidos contra posibles **vicios ocultos o defectos de fabricación**. La durabilidad y correcto funcionamiento de los productos dependerán del cumplimiento de las siguientes condiciones:

- **Instalación de empotrables de suelo:** Está estrictamente prohibido el uso de atornilladores mecánicos en estos productos, ya que podría causar roturas o aplicar un **par de apriete incorrecto** en los tornillos.
- **Uso de cableado:** Es obligatorio utilizar el cable recomendado por el fabricante o uno de calidad superior. En ningún caso deben dejarse cables expuestos o sin protección, para evitar daños graves o problemas relacionados con la humedad o la capilaridad.
- **Sustitución de piezas:** Cualquier sustitución de una pieza **NO** original suministrada por el fabricante (incluyendo la tornillería) **anulará automáticamente la garantía** del producto.
- **Uso de silicona:** La aplicación de silicona exime a NOVOLUX de toda responsabilidad sobre el producto.
- **Manipulación no autorizada:** La manipulación del producto por personal no cualificado o sin la debida autorización **anulará automáticamente la garantía**.
- **Racor (prensaestopas):** Un uso incorrecto del racor **anulará la garantía** del producto.
- **Responsabilidad del instalador:** NOVOLUX recuerda a sus clientes que la instalación de sus productos en lugares de concurrencia pública es responsabilidad exclusiva del **prescriptor o instalador**, ya que NOVOLUX se dedica únicamente a la venta de iluminación para interiores y exteriores residenciales.
- **Selección del material:** La correcta selección del material es responsabilidad del cliente. Cualquier aplicación incorrecta del mismo **exime a NOVOLUX de responsabilidad**.
- **Responsabilidad limitada:** NOVOLUX solo se hará responsable de la calidad de sus productos si se siguen las recomendaciones indicadas. Queda exonerada de cualquier responsabilidad en casos de:
 - Aplicación incorrecta de las luminarias o lámparas.
 - Suministro eléctrico inadecuado.
 - Incumplimiento de las instrucciones de instalación y mantenimiento.
 - Cualquier daño causado por agentes externos.

• **Gastos adicionales:** Los costos derivados de la solución de problemas ajenos a la calidad de la luminaria (como desplazamientos de técnicos o reparaciones no relacionadas con defectos del producto) **serán facturados al cliente**.

11. Reserva de Propiedad

- NOVOLUX se reserva el derecho de propiedad sobre todos los materiales suministrados hasta que el comprador haya realizado el pago total de los mismos.

12. Jurisdicción

- Para cualquier discrepancia o litigio que surja de las presentes Condiciones Generales de Venta, ambas partes se someten a la jurisdicción de los Juzgados y Tribunales de Barcelona, renunciando expresamente a su propio fuero.

REF.	FAM.	BRAND	PAG.
003A-G05X1A-30	ABREGO	DOPO	523
003B-G05X1A-30	ABREGO	DOPO	622
025C-L3106B10-02	BAMBOLA	CRISTHER	805
025C-L3106B30-02	BAMBOLA	CRISTHER	805
025C-L3306B10-02	BAMBOLA	CRISTHER	805
025C-L3306B30-02	BAMBOLA	CRISTHER	805
030D-L0318D-01	BELT	CRISTHER	847
030D-L0418D-01	BELT	CRISTHER	847
036A-G05X1A-01T	BOOM	DOPO	652
036A-G05X1A-02T	BOOM	DOPO	652
036B-G05X1A-01T	BOOM	DOPO	652
036B-G05X1A-02T	BOOM	DOPO	652
036D-G05X1A-01T	BOOM	DOPO	653
036D-G05X1A-02T	BOOM	DOPO	653
036E-G05X1A-01T	BOOM	DOPO	653
036E-G05X1A-02T	BOOM	DOPO	653
036F-G05X1A-01T	BOOM	DOPO	653
036F-G05X1A-02T	BOOM	DOPO	653
037A-G21X1A-30	BORA	DOPO	556
037B-G21X1A-30	BORA	DOPO	556
037D-G21X1A-30	BORA	DOPO	556
046C-G05X1A-01T	CAST	DOPO	654
046C-G05X1A-02T	CAST	DOPO	654
046E-G05X1A-01T	CAST	DOPO	654
046E-G05X1A-02T	CAST	DOPO	654
046G-G05X1A-01T	CAST	DOPO	654
046G-G05X1A-02T	CAST	DOPO	654
051A-G05X1A-04	CICLON	DOPO	517
051B-G05X1A-04	CICLON	DOPO	517
056B-G05X1A-02	CITY INDURA	DOPO	679
056D-G05X1A-02	CITY INDURA	DOPO	679
057B-G05X1A-02	INDURA GLOBO	DOPO	656
057D-G05X1A-02	INDURA GLOBO	DOPO	659
057E-G05X1A-02	INDURA GLOBO	DOPO	659
057F-G05X1A-02	INDURA GLOBO	DOPO	659
059A-G05X1A-01	CLIC-CLAC 4	DOPO	676
059A-G05X1A-02	CLIC-CLAC 4	DOPO	676
059B-G05X1A-01	CLIC-CLAC 4	DOPO	677
059B-G05X1A-02	CLIC-CLAC 4	DOPO	677
059C-G05X1A-01	CLIC-CLAC 4	DOPO	677
059C-G05X1A-02	CLIC-CLAC 4	DOPO	677
059G-G05X1A-01	CLIC-CLAC 4	DOPO	676
059G-G05X1A-02	CLIC-CLAC 4	DOPO	676
059H-G05X1A-01	CLIC-CLAC 4	DOPO	676
059H-G05X1A-02	CLIC-CLAC 4	DOPO	676
059I-G05X1A-01	CLIC-CLAC 4	DOPO	676
059I-G05X1A-02	CLIC-CLAC 4	DOPO	676
059J-G05X1A-01	CLIC-CLAC 4	DOPO	677
059J-G05X1A-02	CLIC-CLAC 4	DOPO	677
060A-G05X1A-01	CLIC-CLAC 6	DOPO	688
060A-G05X1A-02	CLIC-CLAC 6	DOPO	688
060B-G05X1A-01	CLIC-CLAC 6	DOPO	688
060B-G05X1A-02	CLIC-CLAC 6	DOPO	688
060D-G05X1A-01	CLIC-CLAC 6	DOPO	689
060D-G05X1A-02	CLIC-CLAC 6	DOPO	689
060E-G05X1A-01	CLIC-CLAC 6	DOPO	689
060E-G05X1A-02	CLIC-CLAC 6	DOPO	689

REF.	FAM.	BRAND	PAG.
060G-G05X1A-01	CLIC-CLAC 6	DOPO	688
060G-G05X1A-02	CLIC-CLAC 6	DOPO	688
060H-G05X1A-01	CLIC-CLAC 6	DOPO	688
060H-G05X1A-02	CLIC-CLAC 6	DOPO	688
060J-G05X1A-01	CLIC-CLAC 6	DOPO	689
060J-G05X1A-02	CLIC-CLAC 6	DOPO	689
061B-G05X1A-01	CLIC-CLAC GLOBO	DOPO	662
061B-G05X1A-02	CLIC-CLAC GLOBO	DOPO	662
061D-G05X1A-01	CLIC-CLAC GLOBO	DOPO	663
061D-G05X1A-02	CLIC-CLAC GLOBO	DOPO	663
061E-G05X1A-01	CLIC-CLAC GLOBO	DOPO	663
061E-G05X1A-02	CLIC-CLAC GLOBO	DOPO	663
061G-G05X1A-01	CLIC-CLAC GLOBO	DOPO	662
061G-G05X1A-02	CLIC-CLAC GLOBO	DOPO	662
061H-G05X1A-01	CLIC-CLAC GLOBO	DOPO	662
061H-G05X1A-02	CLIC-CLAC GLOBO	DOPO	662
061I-G05X1A-01	CLIC-CLAC GLOBO	DOPO	662
061I-G05X1A-02	CLIC-CLAC GLOBO	DOPO	662
061J-G05X1A-01	CLIC-CLAC GLOBO	DOPO	663
061J-G05X1A-02	CLIC-CLAC GLOBO	DOPO	663
063A-G05X1A-01	COC	CRISTHER	744
063A-G05X1A-02	COC	CRISTHER	744
063B-G05X1A-01	COC	CRISTHER	744
063B-G05X1A-02	COC	CRISTHER	744
068A-G05X1A-02	COK	CRISTHER	831
068A-G05X1A-04	COK	CRISTHER	831
068B-G05X1A-02	COK	CRISTHER	831
068B-G05X1A-04	COK	CRISTHER	831
068C-G05X1A-02	COK	CRISTHER	831
068C-G05X1A-04	COK	CRISTHER	831
068D-G05X1A-02	COK	CRISTHER	831
068D-G05X1A-04	COK	CRISTHER	831
077C-L0303D-01	CUP	CRISTHER	853
077C-L0403D-01	CUP	CRISTHER	853
084A-G31X1A-01	DEVON	DOPO	837
084A-G31X1A-02	DEVON	DOPO	837
084A-G31X1A-03	DEVON	DOPO	837
084A-G31X2A-01	DEVON	DOPO	837
084A-G31X2A-02	DEVON	DOPO	837
084A-G31X2A-03	DEVON	DOPO	837
084B-G31X2A-02	DEVON	DOPO	539
084B-G31X2A-03	DEVON	DOPO	539
084C-G31X1A-01	DEVON	DOPO	538
084C-G31X1A-03	DEVON	DOPO	538
084C-G31X2A-01	DEVON	DOPO	538
084C-G31X2A-02	DEVON	DOPO	538
084C-G31X2A-03	DEVON	DOPO	539
084D-G31X1A-02	DEVON	DOPO	539
084D-G31X1A-03	DEVON	DOPO	539
084F-G31X1A-02	DEVON	DOPO	539
084F-G31X1A-03	DEVON	DOPO	539
084G-G31X1A-01	DEVON	DOPO	837
084G-G31X1A-02	DEVON	DOPO	837
084G-G31X1A-03	DEVON	DOPO	837
084I-G31X1A-01	DEVON	DOPO	538
084I-G31X1A-02	DEVON	DOPO	538
084I-G31X1A-03	DEVON	DOPO	538

REF.	FAM.	BRAND	PAG.
084K-G31X1A-02	DEVON	DOPO	536
084K-G31X1A-03	DEVON	DOPO	536
084Q-G31X1A-02	DEVON	DOPO	536
084Q-G31X1A-03	DEVON	DOPO	536
084U-G31X2A-01	DEVON	DOPO	536
084U-G31X2A-02	DEVON	DOPO	536
084U-G31X2A-03	DEVON	DOPO	536
096A-G04X1A-01T	ELITE 6	DOPO	690
096A-G04X1A-02T	ELITE 6	DOPO	690
096B-G05X1A-01T	ELITE 6	DOPO	691
096B-G05X1A-02T	ELITE 6	DOPO	691
096C-G05X1A-01T	ELITE 6	DOPO	691
096C-G05X1A-02T	ELITE 6	DOPO	691
096D-G05X1A-01T	ELITE 6	DOPO	690
096D-G05X1A-02T	ELITE 6	DOPO	690
096E-G05X1A-01T	ELITE 6	DOPO	690
096E-G05X1A-02T	ELITE 6	DOPO	690
096F-G05X1A-01T	ELITE 6	DOPO	690
096F-G05X1A-02T	ELITE 6	DOPO	690
096G-G05X1A-01T	ELITE 6	DOPO	690
096G-G05X1A-02T	ELITE 6	DOPO	690
096H-G05X1A-01T	ELITE 6	DOPO	690
096H-G05X1A-02T	ELITE 6	DOPO	690
096I-G05X1A-01T	ELITE 6	DOPO	690
096I-G05X1A-02T	ELITE 6	DOPO	690
096J-G05X1A-01T	ELITE 6	DOPO	690
096J-G05X1A-02T	ELITE 6	DOPO	690
096K-G05X1A-01T	ELITE 6	DOPO	691
096K-G05X1A-02T	ELITE 6	DOPO	691
096L-G05X1A-01T	ELITE 6	DOPO	691
096L-G05X1A-02T	ELITE 6	DOPO	691
096M-G05X1A-01T	ELITE 6	DOPO	691
096M-G05X1A-02T	ELITE 6	DOPO	691
096N-G05X1A-01T	ELITE 6	DOPO	691
096N-G05X1A-02T	ELITE 6	DOPO	691
096O-G05X1A-01T	ELITE 6	DOPO	691
096O-G05X1A-02T	ELITE 6	DOPO	691
096P-G05X1A-01T	ELITE 6	DOPO	691
096P-G05X1A-02T	ELITE 6	DOPO	691
096Q-G05X1A-01T	ELITE 6	DOPO	692
096Q-G05X1A-02T	ELITE 6	DOPO	692
096R-G05X1A-01T	ELITE 6	DOPO	692
096R-G05X1A-02T	ELITE 6	DOPO	692
096S-G05X1A-01T	ELITE 6	DOPO	692
096S-G05X1A-02T	ELITE 6	DOPO	692
096T-G05X1A-01T	ELITE 6	DOPO	692
096T-G05X1A-02T	ELITE 6	DOPO	692
096U-G05X1A-01T	ELITE 6	DOPO	692
096U-G05X1A-02T	ELITE 6	DOPO	692
096V-G05X1A-01T	ELITE 6	DOPO	692
096V-G05X1A-02T	ELITE 6	DOPO	692
107B-G05X1A-01	FAR	DOPO	534
107B-G05X1A-02	FAR	DOPO	534
107G-G05X1A-01	FAR	DOPO	534
107G-G05X1A-02	FAR	DOPO	534
107H-G05X1A-01	FAR	DOPO	534
107H-G05X1A-02	FAR	DOPO	534

REF.	FAM.	BRAND	PAG.
107I-L0212B-01	FAR	DOPO	532
107I-L0212B-02	FAR	DOPO	532
107J-L0212B-01	FAR	DOPO	532
107J-L0212B-02	FAR	DOPO	532
107K-L0212R-01	FAR	DOPO	532
107L-L0212R-01	FAR	DOPO	532
113A-L2105A-02	FOCUS	CRISTHER	760
113A-L2305B-02	FOCUS	CRISTHER	855
113A-L2305D-02	FOCUS	CRISTHER	855
113B-L2305B-02	FOCUS	CRISTHER	855
117B-G05X1A-30	GALERNA	DOPO	623
117C-G05X1A-30	GALERNA	DOPO	523
127G-G05X1A-01T	GLOBI	DOPO	661
127G-G05X1A-02T	GLOBI	DOPO	661
127K-G05X1A-01T	GLOBI	DOPO	661
127K-G05X1A-02T	GLOBI	DOPO	661
129E-G05X1A-02	GLOU	DOPO	642
129F-G05X1A-02	GLOU	DOPO	642
129G-G05X1A-02	GLOU	DOPO	642
129H-G05X1A-02	GLOU	DOPO	642
144B-G05X1A-02	INDURA BIG 6	DOPO	686
144D-G05X1A-02	INDURA BIG 6	DOPO	687
144E-G05X1A-02	INDURA BIG 6	DOPO	687
144F-G05X1A-02	INDURA BIG 6	DOPO	687
144G-G05X1A-02	INDURA BIG 6	DOPO	686
145I-G05X1A-02	INDURA GLOBO	DOPO	657
146B-G05X1A-02	INDURA MEDIUM 4	DOPO	680
146D-G05X1A-02	INDURA MEDIUM 4	DOPO	680
146D-G31X1A-02	INDURA MEDIUM 4	DOPO	680
146E-G05X1A-02	INDURA MEDIUM 4	DOPO	680
146E-G31X1A-02	INDURA MEDIUM 4	DOPO	680
146H-G05X1A-02	INDURA MEDIUM 4	DOPO	680
147A-G05X1A-02	INDURA MEDIUM 6	DOPO	684
147B-G05X1A-02	INDURA MEDIUM 6	DOPO	684
147D-G05X1A-02	INDURA MEDIUM 6	DOPO	685
147E-G05X1A-02	INDURA MEDIUM 6	DOPO	685
147F-G05X1A-02	INDURA MEDIUM 6	DOPO	685
147H-G05X1A-02	INDURA MEDIUM 6	DOPO	684
147I-G05X1A-02	INDURA MEDIUM 6	DOPO	684
148D-G05X1A-02	INDURA GLOBO	DOPO	658
148E-G05X1A-02	INDURA GLOBO	DOPO	658
148H-G05X1A-02	INDURA GLOBO	DOPO	657
149B-G05X1A-02	INDURA MINI 4	DOPO	682
149G-G05X1A-02	INDURA MINI 4	DOPO	682
149H-G05X1A-02	INDURA MINI 4	DOPO	682
149I-G05X1A-02	INDURA MINI 4	DOPO	682
150B-G05X1A-02	INDURA MINI 6	DOPO	683
150C-G05X1A-02	INDURA MINI 6	DOPO	683
150H-G05X1A-02	INDURA MINI 6	DOPO	683
150I-G05X1A-02	INDURA MINI 6	DOPO	683
151A-G05X1A-02	INDURA GLOBO	DOPO	656
151D-G05X1A-02	INDURA GLOBO	DOPO	658
151E-G05X1A-02	INDURA GLOBO	DOPO	658
151H-G05X1A-02	INDURA GLOBO	DOPO	657
151I-G05X1A-02	INDURA GLOBO	DOPO	657
152A-L02X1K-03S	INTI	CRISTHER	786
152A-L07X1K-03S	INTI	CRISTHER	786

REF.	FAM.	BRAND	PAG.
152B-L02XIK-03S	INTI	CRISTHER	786
152B-L07XIK-03S	INTI	CRISTHER	786
152C-L02XIK-03S	INTI	CRISTHER	786
152C-L07XIK-03S	INTI	CRISTHER	786
152D-L02XIK-03S	INTI	CRISTHER	786
152D-L07XIK-03S	INTI	CRISTHER	786
157A-H20XIA-01	ISORA	CRISTHER	721
157A-H20XIA-02	ISORA	CRISTHER	721
157A-H20XIA-03	ISORA	CRISTHER	721
157A-H20XIA-04	ISORA	CRISTHER	721
157A-H20XIA-91	ISORA	CRISTHER	720
157A-L0105B-01	ISORA	CRISTHER	720
157A-L0105B-02	ISORA	CRISTHER	720
157A-L0105B-03	ISORA	CRISTHER	720
157A-L0105B-04	ISORA	CRISTHER	720
157A-L0105B-91	ISORA	CRISTHER	720
157A-L0205B-01	ISORA	CRISTHER	720
157A-L0205B-02	ISORA	CRISTHER	720
157A-L0205B-03	ISORA	CRISTHER	720
157A-L0205B-04	ISORA	CRISTHER	720
157A-L0205B-91	ISORA	CRISTHER	720
157A-L3805B-01	ISORA	CRISTHER	720
157A-L3805B-02	ISORA	CRISTHER	720
157A-L3805B-03	ISORA	CRISTHER	720
157A-L3805B-04	ISORA	CRISTHER	720
157A-L3805B-91	ISORA	CRISTHER	720
157B-H20XIA-01	ISORA	CRISTHER	721
157B-H20XIA-02	ISORA	CRISTHER	721
157B-H20XIA-03	ISORA	CRISTHER	721
157B-H20XIA-04	ISORA	CRISTHER	721
157B-H20XIA-91	ISORA	CRISTHER	721
157B-L01G8B-01	ISORA	CRISTHER	720
157B-L01G8B-02	ISORA	CRISTHER	720
157B-L01G8B-03	ISORA	CRISTHER	720
157B-L01G8B-04	ISORA	CRISTHER	720
157B-L01G8B-91	ISORA	CRISTHER	720
157B-L02G8B-01	ISORA	CRISTHER	720
157B-L02G8B-02	ISORA	CRISTHER	720
157B-L02G8B-03	ISORA	CRISTHER	720
157B-L02G8B-04	ISORA	CRISTHER	720
157B-L02G8B-91	ISORA	CRISTHER	720
157B-L38G8B-01	ISORA	CRISTHER	720
157B-L38G8B-02	ISORA	CRISTHER	720
157B-L38G8B-03	ISORA	CRISTHER	720
157B-L38G8B-04	ISORA	CRISTHER	720
157B-L38G8B-91	ISORA	CRISTHER	720
157C-G05XIA-01	ISORA	CRISTHER	723
157C-G05XIA-02	ISORA	CRISTHER	723
157C-G05XIA-03	ISORA	CRISTHER	723
157C-G05XIA-04	ISORA	CRISTHER	723
157C-G05XIA-91	ISORA	CRISTHER	723
157C-L0109B-01	ISORA	CRISTHER	722
157C-L0109B-02	ISORA	CRISTHER	722
157C-L0109B-03	ISORA	CRISTHER	722
157C-L0109B-04	ISORA	CRISTHER	722
157C-L0109B-91	ISORA	CRISTHER	722
157C-L01RDB-01	ISORA	CRISTHER	722

REF.	FAM.	BRAND	PAG.
157C-L01RDB-02	ISORA	CRISTHER	722
157C-L01RDB-03	ISORA	CRISTHER	722
157C-L01RDB-04	ISORA	CRISTHER	722
157C-L01RDB-91	ISORA	CRISTHER	722
157C-L0209B-01	ISORA	CRISTHER	722
157C-L0209B-02	ISORA	CRISTHER	722
157C-L0209B-03	ISORA	CRISTHER	722
157C-L0209B-04	ISORA	CRISTHER	722
157C-L0209B-91	ISORA	CRISTHER	722
157C-L02RDB-01	ISORA	CRISTHER	722
157C-L02RDB-02	ISORA	CRISTHER	722
157C-L02RDB-03	ISORA	CRISTHER	722
157C-L02RDB-04	ISORA	CRISTHER	722
157C-L02RDB-91	ISORA	CRISTHER	722
157C-L3006B-01	ISORA	CRISTHER	722
157C-L3006B-02	ISORA	CRISTHER	722
157C-L3006B-03	ISORA	CRISTHER	722
157C-L3006B-04	ISORA	CRISTHER	722
157C-L3006B-91	ISORA	CRISTHER	722
157C-L30RDB-01	ISORA	CRISTHER	722
157C-L30RDB-02	ISORA	CRISTHER	722
157C-L30RDB-03	ISORA	CRISTHER	722
157C-L30RDB-04	ISORA	CRISTHER	722
157C-L30RDB-91	ISORA	CRISTHER	722
157D-G05XIA-01	ISORA	CRISTHER	723
157D-G05XIA-02	ISORA	CRISTHER	723
157D-G05XIA-03	ISORA	CRISTHER	723
157D-G05XIA-04	ISORA	CRISTHER	723
157D-G05XIA-91	ISORA	CRISTHER	723
157D-L01G9B-01	ISORA	CRISTHER	722
157D-L01G9B-02	ISORA	CRISTHER	722
157D-L01G9B-03	ISORA	CRISTHER	722
157D-L01G9B-04	ISORA	CRISTHER	722
157D-L01G9B-91	ISORA	CRISTHER	722
157D-L01RDB-01	ISORA	CRISTHER	722
157D-L01RDB-02	ISORA	CRISTHER	722
157D-L01RDB-03	ISORA	CRISTHER	722
157D-L01RDB-04	ISORA	CRISTHER	722
157D-L01RDB-91	ISORA	CRISTHER	722
157D-L02G9B-01	ISORA	CRISTHER	722
157D-L02G9B-02	ISORA	CRISTHER	722
157D-L02G9B-03	ISORA	CRISTHER	722
157D-L02G9B-04	ISORA	CRISTHER	722
157D-L02G9B-91	ISORA	CRISTHER	722
157D-L02RDB-01	ISORA	CRISTHER	722
157D-L02RDB-02	ISORA	CRISTHER	722
157D-L02RDB-03	ISORA	CRISTHER	722
157D-L02RDB-04	ISORA	CRISTHER	722
157D-L02RDB-91	ISORA	CRISTHER	722
157D-L30G6B-01	ISORA	CRISTHER	722
157D-L30G6B-02	ISORA	CRISTHER	722
157D-L30G6B-03	ISORA	CRISTHER	722
157D-L30G6B-04	ISORA	CRISTHER	722
157D-L30G6B-91	ISORA	CRISTHER	722
157D-L30RDB-01	ISORA	CRISTHER	722
157D-L30RDB-02	ISORA	CRISTHER	722
157D-L30RDB-03	ISORA	CRISTHER	722

REF.	FAM.	BRAND	PAG.
157D-L30RDB-04	ISORA	CRISTHER	722
157D-L30RDB-91	ISORA	CRISTHER	722
159A-G05X1A-03	JASMIN	DOPO	616
159A-G05X1A-04	JASMIN	DOPO	616
166A-L0109B-01	KAPPA	DOPO	535
166A-L0109B-02	KAPPA	DOPO	535
166A-L0209B-01	KAPPA	DOPO	535
166A-L0209B-02	KAPPA	DOPO	535
166B-L0109B-01	KAPPA	DOPO	535
166B-L0109B-02	KAPPA	DOPO	535
166B-L0209B-01	KAPPA	DOPO	535
166B-L0209B-02	KAPPA	DOPO	535
167A-G05X1A-02T	KEO	DOPO	649
167B-G05X1A-02T	KEO	DOPO	649
167H-G05X1A-02T	KEO	DOPO	649
169A-G05X1A-03	KIRA	DOPO	522
169A-G05X1A-04	KIRA	DOPO	522
169C-G05X1A-04	KIRA	DOPO	522
172A-G21X1A-30	KOBE	DOPO	580
194A-G05X1A-01T	MEDI	DOPO	649
194A-G05X1A-02T	MEDI	DOPO	649
194B-G05X1A-01T	MEDI	DOPO	649
194B-G05X1A-02T	MEDI	DOPO	649
200AS-L0407FC0-00	NILO RGB	INDELUZ	212
200AS-L0414FC0-00	NILO RGB	INDELUZ	212
200AS-L1416FC0-00	NILO RGB+W	INDELUZ	214
200AS-L3805FC0-00	NILO 8-10	INDELUZ	206
200AS-L3810FC0-00	NILO 8-10	INDELUZ	206
200AS-L3814FC0-00	NILO 8-10	INDELUZ	207
200AS-L3819FC0-00	NILO 8-10	INDELUZ	207
200AS-L3905FC0-00	NILO 8-10	INDELUZ	206
200AS-L3910FC0-00	NILO 8-10	INDELUZ	206
200AS-L3914FC0-00	NILO 8-10	INDELUZ	207
200AS-L3919FC0-00	NILO 8-10	INDELUZ	207
200AS-L4005FC0-00	NILO 8-10	INDELUZ	206
200AS-L4010FC0-00	NILO 8-10	INDELUZ	206
200AS-L4014FC0-00	NILO 8-10	INDELUZ	207
200AS-L4019FC0-00	NILO 8-10	INDELUZ	207
200DS-L0407FC0-00	NILO RGB	INDELUZ	213
200DS-L0414FC0-00	NILO RGB	INDELUZ	213
200DS-L1416FC0-00	NILO RGB+W	INDELUZ	214
200DS-L3805FC0-00	NILO 8-10	INDELUZ	208
200DS-L3810FC0-00	NILO 8-10	INDELUZ	208
200DS-L3814FC0-00	NILO 8-10	INDELUZ	209
200DS-L3819FC0-00	NILO 8-10	INDELUZ	209
200DS-L3905FC0-00	NILO 8-10	INDELUZ	208
200DS-L3910FC0-00	NILO 8-10	INDELUZ	208
200DS-L3914FC0-00	NILO 8-10	INDELUZ	209
200DS-L3919FC0-00	NILO 8-10	INDELUZ	209
200DS-L4005FC0-00	NILO 8-10	INDELUZ	208
200DS-L4010FC0-00	NILO 8-10	INDELUZ	208
200DS-L4014FC0-00	NILO 8-10	INDELUZ	209
200DS-L4019FC0-00	NILO 8-10	INDELUZ	209
201A-G05X1A-03	MINI NICO	CRISTHER	829
201A-G05X1A-04	MINI NICO	CRISTHER	829
201A-G05X1A-90	MINI NICO	CRISTHER	829
201AS-L1416FC0-00	NILO RGB+W	INDELUZ	214

REF.	FAM.	BRAND	PAG.
201AS-L3012FC0-00	NILO BASIC	INDELUZ	204
201AS-L3112FC0-00	NILO BASIC	INDELUZ	204
201AS-L3312FC0-00	NILO BASIC	INDELUZ	204
201B-G05X1A-03	MINI NICO	CRISTHER	829
201B-G05X1A-04	MINI NICO	CRISTHER	829
201B-G05X1A-90	MINI NICO	CRISTHER	829
201DS-L1416FC0-00	NILO RGB+W	INDELUZ	214
201DS-L3012FC0-00	NILO BASIC	INDELUZ	205
201DS-L3112FC0-00	NILO BASIC	INDELUZ	205
201DS-L3312FC0-00	NILO BASIC	INDELUZ	205
202AC-L3810FC0-00	RINS	INDELUZ	218
202AC-L3814FC0-00	RINS	INDELUZ	218
202AC-L3910FC0-00	RINS	INDELUZ	218
202AC-L3914FC0-00	RINS	INDELUZ	218
202AC-L4010FC0-00	RINS	INDELUZ	218
202AC-L4014FC0-00	RINS	INDELUZ	218
202AS-L1416FC0-00	NILO RGB+W	INDELUZ	214
202DC-L3810FC0-00	RINS	INDELUZ	219
202DC-L3814FC0-00	RINS	INDELUZ	219
202DC-L3910FC0-00	RINS	INDELUZ	219
202DC-L3914FC0-00	RINS	INDELUZ	219
202DC-L4010FC0-00	RINS	INDELUZ	219
202DC-L4014FC0-00	RINS	INDELUZ	219
202DS-L1416FC0-00	NILO RGB+W	INDELUZ	214
203AS-L3809FC0-00	NILO 5	INDELUZ	210
203AS-L3814FC0-00	NILO 5	INDELUZ	210
203AS-L3909FC0-00	NILO 5	INDELUZ	210
203AS-L3914FC0-00	NILO 5	INDELUZ	210
203AS-L4009FC0-00	NILO 5	INDELUZ	210
203AS-L4014FC0-00	NILO 5	INDELUZ	210
203B-G05X1A-01	MIR	DOPO	529
203B-G05X1A-02	MIR	DOPO	529
203DS-L3809FC0-00	NILO 5	INDELUZ	211
203DS-L3814FC0-00	NILO 5	INDELUZ	211
203DS-L3909FC0-00	NILO 5	INDELUZ	211
203DS-L3914FC0-00	NILO 5	INDELUZ	211
203DS-L4009FC0-00	NILO 5	INDELUZ	211
203DS-L4014FC0-00	NILO 5	INDELUZ	211
204AS-L3011FC0-00	NILO EFFICIENCY	INDELUZ	216
204AS-L3022FC0-00	NILO EFFICIENCY	INDELUZ	216
204AS-L3111FC0-00	NILO EFFICIENCY	INDELUZ	216
204AS-L3122FC0-00	NILO EFFICIENCY	INDELUZ	216
204AS-L3311FC0-00	NILO EFFICIENCY	INDELUZ	216
204AS-L3322FC0-00	NILO EFFICIENCY	INDELUZ	216
204CH-L3013BC0-00	VOLGA	INDELUZ	222
204CH-L3017BC0-00	VOLGA	INDELUZ	223
204CH-L3113BC0-00	VOLGA	INDELUZ	222
204CH-L3117BC0-00	VOLGA	INDELUZ	223
204CH-L3313BC0-00	VOLGA	INDELUZ	222
204CH-L3317BC0-00	VOLGA	INDELUZ	223
204DS-L3011FC0-00	NILO EFFICIENCY	INDELUZ	217
204DS-L3022FC0-00	NILO EFFICIENCY	INDELUZ	217
204DS-L3111FC0-00	NILO EFFICIENCY	INDELUZ	217
204DS-L3122FC0-00	NILO EFFICIENCY	INDELUZ	217
204DS-L3311FC0-00	NILO EFFICIENCY	INDELUZ	217
204DS-L3322FC0-00	NILO EFFICIENCY	INDELUZ	217
205CN-L0414FC0-00	SENA RGB	INDELUZ	221

REF.	FAM.	BRAND	PAG.
205CN-L3012FC0-00	SENA	INDELIZ	220
205CN-L3112FC0-00	SENA	INDELIZ	220
205CN-L3312FC0-00	SENA	INDELIZ	220
206AS-L5213FC0-00	NILO DUAL	INDELIZ	215
207CN-L3012FC0-00	SENA	INDELIZ	220
207CN-L3112FC0-00	SENA	INDELIZ	220
207CN-L3312FC0-00	SENA	INDELIZ	220
208A-L02XIK-03	MITRA	CRISTHER	787
208A-L07XIK-03	MITRA	CRISTHER	787
208B-L02XIK-03	MITRA	CRISTHER	787
208B-L07XIK-03	MITRA	CRISTHER	787
208C-L02XIK-03	MITRA	CRISTHER	787
208C-L07XIK-03	MITRA	CRISTHER	787
208D-L02XIK-03	MITRA	CRISTHER	787
208D-L07XIK-03	MITRA	CRISTHER	787
213A-L10102F-30	NAT-LED	CRISTHER	770
213A-L1002F-30	NAT-LED	CRISTHER	770
213B-L10102F-30	NAT-LED	CRISTHER	770
213B-L1002F-30	NAT-LED	CRISTHER	770
222B-G05XIA-02	NOVA	CRISTHER	830
222B-L3115B-02	NOVA	CRISTHER	830
222B-L3315B-02	NOVA	CRISTHER	830
222C-G05XIA-02	NOVA	CRISTHER	830
222C-L3115B-02	NOVA	CRISTHER	830
222C-L3315B-02	NOVA	CRISTHER	830
228A-G05XIA-01	OMO	DOPO	618
228A-G05XIA-02	OMO	DOPO	618
228A-G05XIA-04	OMO	DOPO	618
228A-G05XIA-05	OMO	DOPO	618
228A-G05XIA-91	OMO	DOPO	618
228B-G05XIA-01	OMO	DOPO	618
228B-G05XIA-02	OMO	DOPO	618
228B-G05XIA-04	OMO	DOPO	618
228B-G05XIA-05	OMO	DOPO	618
228B-G05XIA-91	OMO	DOPO	618
228C-G05XIA-01	OMO	DOPO	618
228C-G05XIA-02	OMO	DOPO	618
228C-G05XIA-04	OMO	DOPO	618
228C-G05XIA-05	OMO	DOPO	618
228C-G05XIA-91	OMO	DOPO	618
228D-G05XIA-01	OMO	DOPO	618
228D-G05XIA-02	OMO	DOPO	618
228D-G05XIA-04	OMO	DOPO	618
228D-G05XIA-05	OMO	DOPO	618
228D-G05XIA-91	OMO	DOPO	618
232A-G05XIA-01	PAMPERO	DOPO	519
232A-G05XIA-03	PAMPERO	DOPO	519
233D-L0318D-01	PAR56	CRISTHER	850
233D-L0418D-01	PAR56	CRISTHER	850
240A-G05XIA-01	PLAFF	CRISTHER	739
240A-G05XIA-02	PLAFF	CRISTHER	739
240B-G05XIA-01	PLAFF	CRISTHER	739
240B-G05XIA-02	PLAFF	CRISTHER	739
240C-G05XIA-01	PLAFF	CRISTHER	739
240C-G05XIA-02	PLAFF	CRISTHER	739
240D-G05XIA-01	PLAFF	CRISTHER	739
240D-G05XIA-02	PLAFF	CRISTHER	739

REF.	FAM.	BRAND	PAG.
240E-G05XIA-01	PLAFF	CRISTHER	739
240E-G05XIA-02	PLAFF	CRISTHER	739
253D-L0312D-01	MINI PRAGA	CRISTHER	852
253D-L0412D-01	MINI PRAGA	CRISTHER	852
253E-L0318D-01	PRAGA	CRISTHER	852
253E-L0418D-01	PRAGA	CRISTHER	852
261A-L0109B-04	RIMA	CRISTHER	731
261A-L0209B-04	RIMA	CRISTHER	731
261C-L0105B-04	RIMA	CRISTHER	731
261C-L0205B-04	RIMA	CRISTHER	731
264A-G05XIA-01T	ROB	DOPO	672
264A-G05XIA-02T	ROB	DOPO	672
264B-G05XIA-01T	ROB	DOPO	672
264B-G05XIA-02T	ROB	DOPO	672
264C-G05XIA-01T	ROB	DOPO	672
264C-G05XIA-02T	ROB	DOPO	672
264D-G05XIA-01T	ROB	DOPO	672
264D-G05XIA-02T	ROB	DOPO	672
264E-G05XIA-01T	ROB	DOPO	672
264E-G05XIA-02T	ROB	DOPO	672
264G-G05XIA-01T	ROB	DOPO	673
264G-G05XIA-02T	ROB	DOPO	673
264H-G05XIA-01T	ROB	DOPO	673
264H-G05XIA-02T	ROB	DOPO	673
264K-G05XIA-01T	ROB	DOPO	673
264K-G05XIA-02T	ROB	DOPO	673
264L-G05XIA-01T	ROB	DOPO	673
264L-G05XIA-02T	ROB	DOPO	673
264M-G05XIA-01T	ROB	DOPO	674
264M-G05XIA-02T	ROB	DOPO	674
264N-G05XIA-01T	ROB	DOPO	674
264N-G05XIA-02T	ROB	DOPO	674
264O-G05XIA-01T	ROB	DOPO	674
264O-G05XIA-02T	ROB	DOPO	674
264P-G05XIA-01T	ROB	DOPO	674
264P-G05XIA-02T	ROB	DOPO	674
264Q-G05XIA-01T	ROB	DOPO	674
264Q-G05XIA-02T	ROB	DOPO	674
264R-G05XIA-01T	ROB	DOPO	674
264R-G05XIA-02T	ROB	DOPO	674
272A-G05XIA-02	SAURO	DOPO	621
272A-G31XIA-02	SAURO	DOPO	621
272B-G05XIA-02	SAURO	DOPO	621
272B-G31XIA-02	SAURO	DOPO	621
272C-G05XIA-02	SAURO	DOPO	621
272C-G31XIA-02	SAURO	DOPO	621
286A-G05XIA-03	SIROCO	DOPO	620
286A-G05XIA-04	SIROCO	DOPO	620
289B-L0104B-03	SLIM	CRISTHER	734
289B-L0104B-04	SLIM	CRISTHER	734
289B-L0204B-03	SLIM	CRISTHER	734
289B-L0204B-04	SLIM	CRISTHER	734
289C-L0110B-03	SLIM	CRISTHER	734
289C-L0110B-04	SLIM	CRISTHER	734
289C-L0210B-03	SLIM	CRISTHER	734
289C-L0210B-04	SLIM	CRISTHER	734
289D-L0104B-03	SLIM	CRISTHER	735

REF.	FAM.	BRAND	PAG.
289D-L0104B-04	SLIM	CRISTHER	735
289D-L0204B-03	SLIM	CRISTHER	735
289D-L0204B-04	SLIM	CRISTHER	735
289E-L0110B-03	SLIM	CRISTHER	735
289E-L0110B-04	SLIM	CRISTHER	735
289E-L0210B-03	SLIM	CRISTHER	735
289E-L0210B-04	SLIM	CRISTHER	735
302A-L0105B-04	SURI	CRISTHER	774
302A-L0205B-04	SURI	CRISTHER	774
302B-L0105B-04	SURI	CRISTHER	774
302B-L0205B-04	SURI	CRISTHER	774
302C-L0105B-04	SURI	CRISTHER	774
302C-L0205B-04	SURI	CRISTHER	774
303A-L0106A-04	SURI BIG	CRISTHER	775
303A-L0206A-04	SURI BIG	CRISTHER	775
303B-L0106A-04	SURI BIG	CRISTHER	775
303B-L0206A-04	SURI BIG	CRISTHER	775
303C-L0106A-04	SURI BIG	CRISTHER	775
303C-L0206A-04	SURI BIG	CRISTHER	775
317A-G05X1A-01	TEIA	DOPO	531
317A-G05X1A-02	TEIA	DOPO	531
317A-G05X1A-03	TEIA	DOPO	531
317B-G05X1A-01	TEIA	DOPO	531
317B-G05X1A-02	TEIA	DOPO	531
317B-G05X1A-03	TEIA	DOPO	531
317C-G05X1A-01	TEIA	DOPO	531
317C-G05X1A-02	TEIA	DOPO	531
317C-G05X1A-03	TEIA	DOPO	531
319A-L2105A-02	TIR	CRISTHER	804
319A-L2105A-03	TIR	CRISTHER	804
332B-G05X1A-01T	TROM	DOPO	650
332B-G05X1A-02T	TROM	DOPO	650
332D-G05X1A-01T	TROM	DOPO	651
332D-G05X1A-02T	TROM	DOPO	651
332E-G05X1A-01T	TROM	DOPO	651
332E-G05X1A-02T	TROM	DOPO	651
332F-G05X1A-01T	TROM	DOPO	651
332F-G05X1A-02T	TROM	DOPO	651
332G-G05X1A-01T	TROM	DOPO	650
332G-G05X1A-02T	TROM	DOPO	650
344A-G05X1A-02	VIC	DOPO	660
344B-G05X1A-02	VIC	DOPO	660
344C-G05X1A-02	VIC	DOPO	660
344E-G05X1A-02	VIC	DOPO	660
345A-G05X1A-02	VIC	DOPO	660
345B-G05X1A-02	VIC	DOPO	660
345C-G05X1A-02	VIC	DOPO	660
345D-G05X1A-02	VIC	DOPO	660
346B-G05X1A-02T	VILLA BIG	DOPO	694
346D-G05X1A-02T	VILLA BIG	DOPO	695
348B-G05X1A-02T	VILLA CHAP	DOPO	678
348D-G05X1A-02T	VILLA CHAP	DOPO	678
349A-G05X1A-30	WALKER	DOPO	557
349A-L0107B-30	WALKER	DOPO	557
350A-G05X1A-01	XALOC	DOPO	543
350A-G05X1A-02	XALOC	DOPO	543
350C-G05X1A-30	XALOC	DOPO	543

REF.	FAM.	BRAND	PAG.
350D-G05X1A-30	XALOC	DOPO	543
369D-L2003B-01	G9	NX Lighting	860
369D-L2003B-02	G9	NX Lighting	860
372A-G31X1A-02	BELGRADO	DOPO	560
372B-G31X1A-02	BELGRADO	DOPO	560
372C-G31X1A-02	BELGRADO	DOPO	560
373A-G31X1A-02	BELGRADO	DOPO	560
373B-G31X1A-02	BELGRADO	DOPO	560
373C-G31X1A-02	BELGRADO	DOPO	560
378A-L3103A-02	LED T2	NX Lighting	858
378A-L3106A-01	LED T2	NX Lighting	858
378A-L3106A-02	LED T2	NX Lighting	858
378A-L4103A-01	LED T2	NX Lighting	858
378B-L3107A-02	LED T2	NX Lighting	858
378B-L5210A-01	LED T2	NX Lighting	858
378C-L3111A-01	LED T2	NX Lighting	858
378C-L3111A-02	LED T2	NX Lighting	858
378C-L4115A-01	LED T2	NX Lighting	858
379A-G31X1A-30	SIO	DOPO	553
379B-G31X1A-30	SIO	DOPO	553
382C-L0318D-30	GAMBLE 150	CRISTHER	854
382C-L0418D-30	GAMBLE 150	CRISTHER	854
382C-L04DMX-30	GAMBLE 150	CRISTHER	854
382D-L0324D-30	GAMBLE 220	CRISTHER	854
382D-L0424D-30	GAMBLE 220	CRISTHER	854
382D-L04DMX-30	GAMBLE 220	CRISTHER	854
388A-L3020B-04	MAXIMA	CRISTHER	824
388A-L30RDB-04	MAXIMA	CRISTHER	824
388A-L3120B-04	MAXIMA	CRISTHER	824
388A-L31RDB-04	MAXIMA	CRISTHER	824
388B-L3020B-04	MAXIMA	CRISTHER	824
388B-L30RDB-04	MAXIMA	CRISTHER	824
388B-L3120B-04	MAXIMA	CRISTHER	824
388B-L31RDB-04	MAXIMA	CRISTHER	824
388C-L3036B-04	MAXIMA	CRISTHER	825
388C-L30RDB-04	MAXIMA	CRISTHER	825
388C-L3136B-04	MAXIMA	CRISTHER	825
388C-L31RDB-04	MAXIMA	CRISTHER	825
388D-L3036B-04	MAXIMA	CRISTHER	825
388D-L30RDB-04	MAXIMA	CRISTHER	825
388D-L3136B-04	MAXIMA	CRISTHER	825
388D-L31RDB-04	MAXIMA	CRISTHER	825
388E-L3036B-04	MAXIMA	CRISTHER	825
388E-L30RDB-04	MAXIMA	CRISTHER	825
388E-L3136B-04	MAXIMA	CRISTHER	825
388E-L31RDB-04	MAXIMA	CRISTHER	825
405C-G05X1A-04	ROUND	DOPO	669
405D-G05X1A-04	ROUND	DOPO	669
406C-G05X1A-04	QUADRA	DOPO	670
406D-G05X1A-04	QUADRA	DOPO	670
407B-G31X1A-02	GUNTHER	DOPO	696
407D-G31X1A-02	GUNTHER	DOPO	697
407E-G31X1A-02	GUNTHER	DOPO	697
408B-G31X1A-02	GUNTHER	DOPO	698
408D-G31X1A-02	GUNTHER	DOPO	698
408E-G31X1A-02	GUNTHER	DOPO	698
410A-G21X1A-30	ESTAMBUL	CRISTHER	760

REF.	FAM.	BRAND	PAG.
536A-L0106A-04	CENADI	DOPO	516
537A-L0107A-04	CAIRO	DOPO	515
537B-L0107A-04	CAIRO	DOPO	604
538A-G21X1A-04	ABADIA	DOPO	566
539A-G21X1A-04	ARAMO	DOPO	579
543A-L0103A-03	DAMBEL	DOPO	540
543A-L0103A-04	DAMBEL	DOPO	540
543B-L0103A-03	DAMBEL	DOPO	540
543B-L0103A-04	DAMBEL	DOPO	540
546A-L0101A-30	DONISI	DOPO	545
551B-L0108A-04	BARNI	DOPO	572
552A-L0108A-04	ADRANO	DOPO	612
554A-L0108A-04	BINDELLA	CRISTHER	826
554A-L0108B-04	BINDELLA	CRISTHER	826
555C-G21X1A-01	CUB	DOPO	512
555C-G21X1A-02	CUB	DOPO	512
555C-G21X1A-03	CUB	DOPO	512
555C-G21X1A-04	CUB	DOPO	512
555D-G21X1A-01	CUB	DOPO	512
555D-G21X1A-02	CUB	DOPO	512
555D-G21X1A-03	CUB	DOPO	512
555D-G21X1A-04	CUB	DOPO	512
555E-G21X1A-01	CUB	DOPO	547
555E-G21X1A-02	CUB	DOPO	547
555E-G21X1A-03	CUB	DOPO	547
555E-G21X1A-04	CUB	DOPO	547
555F-G21X1A-01	CUB	DOPO	510
555F-G21X1A-04	CUB	DOPO	510
555G-G21X1A-01	CUB	DOPO	510
555G-G21X1A-04	CUB	DOPO	510
555H-G21X1A-01	CUB	DOPO	547
555H-G21X1A-04	CUB	DOPO	547
557A-G21X1A-02	BELGRADO	DOPO	560
557B-G21X1A-02	BELGRADO	DOPO	560
557C-G21X1A-02	BELGRADO	DOPO	560
559A-G31X1A-01	PIRO	DOPO	530
559A-G31X1A-03	PIRO	DOPO	530
559B-G31X1A-01	PIRO	DOPO	530
559B-G31X1A-02	PIRO	DOPO	530
559B-G31X1A-03	PIRO	DOPO	530
559C-G31X1A-01	PIRO	DOPO	530
559C-G31X1A-02	PIRO	DOPO	530
568A-L0135B-04	VICO	CRISTHER	843
568A-L0150B-04	VICO	CRISTHER	843
568A-L0235B-04	VICO	CRISTHER	843
568A-L0250B-04	VICO	CRISTHER	843
572A-G21X1A-02	LULU	DOPO	568
573A-G05X1A-34	OTTONE	DOPO	648
573B-G05X1A-34	OTTONE	DOPO	648
575A-G05X1A-01	DAIRA	CRISTHER	738
575A-G05X1A-04	DAIRA	CRISTHER	738
575A-L0129R-01	DAIRA	CRISTHER	738
575A-L0129R-04	DAIRA	CRISTHER	738
575B-G05X1A-01	DAIRA	CRISTHER	738
575B-G05X1A-04	DAIRA	CRISTHER	738
575B-L0118B-01	DAIRA	CRISTHER	738
575B-L0118B-04	DAIRA	CRISTHER	738

REF.	FAM.	BRAND	PAG.
575C-G05X1A-01	DAIRA	CRISTHER	738
575C-G05X1A-04	DAIRA	CRISTHER	738
575C-L0118B-01	DAIRA	CRISTHER	738
575C-L0118B-04	DAIRA	CRISTHER	738
578A-L2104A-02	LED PRO	NX Lighting	860
578A-L4104A-01	LED PRO	NX Lighting	860
578C-L4106B-01	LED PRO	INDELUZ	860
580A-L0104B-03	SUM	CRISTHER	732
580A-L0104B-04	SUM	CRISTHER	732
580A-L0204B-03	SUM	CRISTHER	732
580A-L0204B-04	SUM	CRISTHER	732
580B-L0110B-03	SUM	CRISTHER	732
580B-L0110B-04	SUM	CRISTHER	732
580B-L0210B-03	SUM	CRISTHER	732
580B-L0210B-04	SUM	CRISTHER	732
580C-L0104B-03	SUM	CRISTHER	733
580C-L0104B-04	SUM	CRISTHER	733
580C-L0204B-03	SUM	CRISTHER	733
580C-L0204B-04	SUM	CRISTHER	733
580D-L0110B-03	SUM	CRISTHER	733
580D-L0110B-04	SUM	CRISTHER	733
580D-L0210B-03	SUM	CRISTHER	733
580D-L0210B-04	SUM	CRISTHER	733
583C-L13140B-01	HIMMEL	INDELUZ	260
583C-L13340B-01	HIMMEL	INDELUZ	260
585A-G05X1A-02	VINTAGE	EXO	401
588A-L0104A-02	BOOK	EXO	325
595A-G05X1A-35-2ACA	EASY	EXO	404
595A-G05X1A-35-2ACB	EASY	EXO	404
595A-G05X1A-35-2ACC	EASY	EXO	404
618A-G05X1A-02	TANNA	EXO	402
620A-G05X1A-02	VINTAGE	EXO	401
621A-G05X1A-50-9BCA	WOOD	EXO	434
621A-G05X1A-50-9BCG	WOOD	EXO	434
621A-G05X1A-50-9BDC	WOOD	EXO	434
621B-G05X1A-50-9CCA	WOOD	EXO	434
621B-G05X1A-50-9CCG	WOOD	EXO	434
621B-G05X1A-50-9CDC	WOOD	EXO	434
621C-G05X1A-50-CA	COMPACT	EXO	316
621C-G05X1A-50-CG	COMPACT	EXO	316
621C-G05X1A-50-DC	COMPACT	EXO	316
621D-G05X1A-50-CA	COMPACT	EXO	432
621D-G05X1A-50-CG	COMPACT	EXO	432
621D-G05X1A-50-DC	COMPACT	EXO	432
621E-G05X1A-50-CA	COMPACT	EXO	432
621E-G05X1A-50-CG	COMPACT	EXO	432
621E-G05X1A-50-DC	COMPACT	EXO	432
632C-L0506B-01	LED FILAMENT	NX Lighting	859
632C-L0506B-02	LED FILAMENT	NX Lighting	859
632D-L0404B-01	LED FILAMENT	NX Lighting	859
632E-L0404B-01	LED FILAMENT	NX Lighting	859
632F-L0504B-01	LED FILAMENT	NX Lighting	859
632G-L0504B-01	LED FILAMENT	NX Lighting	859
632H-L0504B-01	LED FILAMENT	NX Lighting	859
632J-L0503B-01	LED FILAMENT	NX Lighting	859
634A-L0113B-01	IONA	EXO	342
634A-L0113B-02	IONA	EXO	342

REF.	FAM.	BRAND	PAG.
634A-L013B-03	IONA	EXO	342
634B-L013B-01	IONA	EXO	342
634B-L013B-02	IONA	EXO	342
634B-L013B-03	IONA	EXO	342
634C-G05XIA-01	IONA	EXO	342
634C-G05XIA-02	IONA	EXO	342
634C-G05XIA-03	IONA	EXO	342
642A-G231XD-30	SEDNA	DOPO	581
642A-L0203D-30	SEDNA	DOPO	581
643A-L0109A-04	AMBERES	DOPO	542
645A-L0107A-04	MARTINA	DOPO	561
645A-L0207A-04	MARTINA	DOPO	561
645B-L0107A-04	MARTINA	DOPO	561
645B-L0207A-04	MARTINA	DOPO	561
646A-G05XIA-01	CALM	DOPO	526
646A-G05XIA-02	CALM	DOPO	526
646A-G05XIA-03	CALM	DOPO	526
646B-G05XIA-01	CALM	DOPO	526
646B-G05XIA-02	CALM	DOPO	526
646B-G05XIA-03	CALM	DOPO	526
655A-G31XIA-02	GUNTHER	DOPO	699
661B-L0303D-30	PAL 98 SLIM	CRISTHER	853
661B-L0403B-30	PAL 98 SLIM	CRISTHER	853
665B-L0102F-43	NODY	CRISTHER	771
665B-L0202F-43	NODY	CRISTHER	771
665C-L0102F-43	NODY	CRISTHER	771
665C-L0202F-43	NODY	CRISTHER	771
665E-L0102F-43	NODY	CRISTHER	771
665E-L0202F-43	NODY	CRISTHER	771
665F-L0102F-43	NODY	CRISTHER	771
665F-L0202F-43	NODY	CRISTHER	771
669A-G05XIA-02	MIRCO	CRISTHER	832
669B-L013B-02	MIRCO	CRISTHER	832
669B-L0213B-02	MIRCO	CRISTHER	832
669C-G05XIA-02	MIRCO	CRISTHER	832
669D-G05XIA-02	MIRCO	CRISTHER	832
673A-L0224A-39	ARYA	CRISTHER	842
673A-L0236A-39	ARYA	CRISTHER	842
673A-L3024A-39	ARYA	CRISTHER	842
673A-L3024AAD-39	ARYA	CRISTHER	842
673A-L3036A-39	ARYA	CRISTHER	842
673A-L3036AAD-39	ARYA	CRISTHER	842
673A-L3224AAD-39	ARYA	CRISTHER	842
673A-L3236AAD-39	ARYA	CRISTHER	842
684A-G05XIA-02	ELGA	EXO	400
685A-G05XIA-02	BAGUET	EXO	398
685B-G05XIA-02	BAGUET	EXO	398
695A-L0112B-01	DENEB	EXO	341
703A-G05XIA-02-9BCA	KARA	EXO	436
703A-G05XIA-02-9BCB	KARA	EXO	436
703A-G05XIA-02-9BCG	KARA	EXO	436
703A-G05XIA-02-9BDC	KARA	EXO	436
703A-G05XIA-50-9BCA	KARA	EXO	436
703A-G05XIA-50-9BCB	KARA	EXO	436
703A-G05XIA-50-9BCG	KARA	EXO	436
703A-G05XIA-50-9BDC	KARA	EXO	436
703B-G05XIA-02-9CCA	KARA	EXO	436

REF.	FAM.	BRAND	PAG.
703B-G05XIA-02-9CCB	KARA	EXO	436
703B-G05XIA-02-9CCG	KARA	EXO	436
703B-G05XIA-02-9CCD	KARA	EXO	436
703B-G05XIA-50-9CCA	KARA	EXO	436
703B-G05XIA-50-9CCB	KARA	EXO	436
703B-G05XIA-50-9CCG	KARA	EXO	436
703B-G05XIA-50-9CCD	KARA	EXO	436
704A-L0103B-01	DIRK	EXO	326
704A-L0103B-02	DIRK	EXO	326
704A-L0103B-02-46	DIRK	EXO	326
704B-L0103B-01	DIRK	EXO	326
704B-L0103B-02	DIRK	EXO	326
704B-L0103B-02-46	DIRK	EXO	326
704C-L0103B-01	DIRK	EXO	326
704C-L0103B-02	DIRK	EXO	326
704C-L0103B-02-46	DIRK	EXO	326
706A-L0103B-01	LIGUR	INDELUX	269
706A-L0103B-39	LIGUR	INDELUX	269
706B-L0103B-01	LIGUR	INDELUX	269
706B-L0103B-39	LIGUR	INDELUX	269
715A-L0125A-01	FRED	EXO	392
715A-L0125A-02	FRED	EXO	392
715A-L0125A-03	FRED	EXO	392
715B-L3135A-01	FRED	EXO	392
715B-L3135A-02	FRED	EXO	392
715B-L3135A-03	FRED	EXO	392
717D-G05XIA-01	A TU ESTILO	EXO	396
717D-G05XIA-02	A TU ESTILO	EXO	396
717D-G05XIA-32	A TU ESTILO	EXO	396
717E-G05XIA-01	A TU ESTILO	EXO	396
717E-G05XIA-02	A TU ESTILO	EXO	396
717E-G05XIA-32	A TU ESTILO	EXO	396
717F-G05XIA-01	A TU ESTILO	EXO	396
717F-G05XIA-02	A TU ESTILO	EXO	396
717F-G05XIA-32	A TU ESTILO	EXO	396
726A-L0103B-01	WINDOW 2	INDELUX	268
726A-L0103B-39	WINDOW 2	INDELUX	268
727G-L0103B-01	BALTIC	EXO	334
727G-L0103B-02	BALTIC	EXO	334
731B-L4118B-01	CARME	INDELUX	263
731C-L4130B-01	CARME	INDELUX	263
731D-L4118B-28	CARME	INDELUX	263
731E-L4130B-28	CARME	INDELUX	263
731F-L4118B-28	CARME	INDELUX	263
731G-L4130B-28	CARME	INDELUX	263
738F-G18RCB-01	ATOLON	INDELUX	246
738F-G18RCB-02	ATOLON	INDELUX	246
738F-G18RCB-03	ATOLON	INDELUX	246
738F-G21XIB-01	ATOLON	INDELUX	246
738F-G21XIB-02	ATOLON	INDELUX	246
738F-G21XIB-03	ATOLON	INDELUX	246
738Q-L3117B1M-01	ATOLON	INDELUX	120
738Q-L3117B1M-02	ATOLON	INDELUX	120
738Q-L3117B1M-03	ATOLON	INDELUX	120
738Q-L3125B-01	ATOLON	INDELUX	120
738Q-L3125B-02	ATOLON	INDELUX	120
738Q-L3125B-03	ATOLON	INDELUX	120

REF.	FAM.	BRAND	PAG.
738Q-L31R2B-01	ATOLON	INDELUZ	120
738Q-L31R2B-02	ATOLON	INDELUZ	120
738Q-L31R2B-03	ATOLON	INDELUZ	120
738Q-L3317B1M-01	ATOLON	INDELUZ	120
738Q-L3317B1M-02	ATOLON	INDELUZ	120
738Q-L3317B1M-03	ATOLON	INDELUZ	120
738Q-L3325B-01	ATOLON	INDELUZ	120
738Q-L3325B-02	ATOLON	INDELUZ	120
738Q-L3325B-03	ATOLON	INDELUZ	120
738Q-L33R2B-01	ATOLON	INDELUZ	120
738Q-L33R2B-02	ATOLON	INDELUZ	120
738Q-L33R2B-03	ATOLON	INDELUZ	120
738R-L3117B2M-01	ATOLON	INDELUZ	120
738R-L3117B2M-02	ATOLON	INDELUZ	120
738R-L3117B2M-03	ATOLON	INDELUZ	120
738R-L3125B-01	ATOLON	INDELUZ	120
738R-L3125B-02	ATOLON	INDELUZ	120
738R-L3125B-03	ATOLON	INDELUZ	120
738R-L31R2B-01	ATOLON	INDELUZ	120
738R-L31R2B-02	ATOLON	INDELUZ	120
738R-L31R2B-03	ATOLON	INDELUZ	120
738R-L3317B2M-01	ATOLON	INDELUZ	120
738R-L3317B2M-02	ATOLON	INDELUZ	120
738R-L3317B2M-03	ATOLON	INDELUZ	120
738R-L3325B-01	ATOLON	INDELUZ	120
738R-L3325B-02	ATOLON	INDELUZ	120
738R-L3325B-03	ATOLON	INDELUZ	120
738R-L33R2B-01	ATOLON	INDELUZ	120
738R-L33R2B-02	ATOLON	INDELUZ	120
738R-L33R2B-03	ATOLON	INDELUZ	120
741A-	MINI LUNA	INDELUZ	109
741A-G23X1D-01	MINI LUNA	INDELUZ	251
741A-G23X1D-02	MINI LUNA	INDELUZ	251
741A-G23X1D-03	MINI LUNA	INDELUZ	251
741A-G23X1D-32	MINI LUNA	INDELUZ	251
741A-G23X1D-45	MINI LUNA	INDELUZ	251
741A-G23X1D-48	MINI LUNA	INDELUZ	251
741A-G42X1B-01	MINI LUNA	INDELUZ	251
741A-G42X1B-02	MINI LUNA	INDELUZ	251
741A-G42X1B-03	MINI LUNA	INDELUZ	251
741A-G42X1B-32	MINI LUNA	INDELUZ	251
741A-G42X1B-45	MINI LUNA	INDELUZ	251
741A-G42X1B-48	MINI LUNA	INDELUZ	251
749B-G23X1D-01	KOS	INDELUZ	255
749B-G42X1B-01	KOS	INDELUZ	255
750A-	PALMA	INDELUZ	103
750A-G23X1D-01	PALMA	INDELUZ	250
750A-G23X1D-02	PALMA	INDELUZ	250
750A-G23X1D-30	PALMA	INDELUZ	250
750A-G23X1D-32	PALMA	INDELUZ	250
750A-G23X1D-45	PALMA	INDELUZ	250
750A-G23X1D-48	PALMA	INDELUZ	250
750A-G42X1B-01	PALMA	INDELUZ	250
750A-G42X1B-02	PALMA	INDELUZ	250
750A-G42X1B-30	PALMA	INDELUZ	250
750A-G42X1B-32	PALMA	INDELUZ	250
750A-G42X1B-45	PALMA	INDELUZ	250

REF.	FAM.	BRAND	PAG.
750A-G42X1B-48	PALMA	INDELUZ	250
752A-	LEDA	INDELUZ	117
752A-G23X1D-01	LEDA	INDELUZ	257
752A-G23X1D-02	LEDA	INDELUZ	257
752A-G23X1D-03	LEDA	INDELUZ	257
752A-G42X1B-01	LEDA	INDELUZ	257
752A-G42X1B-02	LEDA	INDELUZ	257
752A-G42X1B-03	LEDA	INDELUZ	257
753A-L3202B-01	IBIZA	INDELUZ	262
753A-L3202B-02	IBIZA	INDELUZ	262
753A-L3202B-32	IBIZA	INDELUZ	262
753A-L3202B-45	IBIZA	INDELUZ	262
753B-L3202B-01	IBIZA	INDELUZ	262
753B-L3202B-02	IBIZA	INDELUZ	262
753B-L3202B-32	IBIZA	INDELUZ	262
753B-L3202B-45	IBIZA	INDELUZ	262
757B-L3108B-01	KALE	INDELUZ	256
757C-L3120B-01	KALE	INDELUZ	256
772A-G21X1B-01	HAITI	INDELUZ	277
772A-G21X1B-02	HAITI	INDELUZ	277
772A-G21X1B-03	HAITI	INDELUZ	277
772B-G18RCB-01	HAITI	INDELUZ	276
772B-G18RCB-02	HAITI	INDELUZ	276
772B-G18RCB-03	HAITI	INDELUZ	276
772B-G21X1B-01	HAITI	INDELUZ	277
772B-G21X1B-02	HAITI	INDELUZ	277
772B-G21X1B-03	HAITI	INDELUZ	277
772B-H18RCB-01	HAITI	INDELUZ	276
772B-H18RCB-02	HAITI	INDELUZ	276
772B-H18RCB-03	HAITI	INDELUZ	276
772L-L3125B-01	HAITI	INDELUZ	184
772L-L3125B-02	HAITI	INDELUZ	184
772L-L3125B-03	HAITI	INDELUZ	184
772L-L31RDB-01	HAITI	INDELUZ	184
772L-L31RDB-02	HAITI	INDELUZ	184
772L-L31RDB-03	HAITI	INDELUZ	184
772L-L3325B-01	HAITI	INDELUZ	184
772L-L3325B-02	HAITI	INDELUZ	184
772L-L3325B-03	HAITI	INDELUZ	184
772L-L33RDB-01	HAITI	INDELUZ	184
772L-L33RDB-02	HAITI	INDELUZ	184
772L-L33RDB-03	HAITI	INDELUZ	184
772M-L3125B-01	HAITI	INDELUZ	184
772M-L3125B-02	HAITI	INDELUZ	184
772M-L3125B-03	HAITI	INDELUZ	184
772M-L31RDB-01	HAITI	INDELUZ	184
772M-L31RDB-02	HAITI	INDELUZ	184
772M-L31RDB-03	HAITI	INDELUZ	184
772M-L3325B-01	HAITI	INDELUZ	184
772M-L3325B-02	HAITI	INDELUZ	184
772M-L3325B-03	HAITI	INDELUZ	184
772M-L33RDB-01	HAITI	INDELUZ	184
772M-L33RDB-02	HAITI	INDELUZ	184
772M-L33RDB-03	HAITI	INDELUZ	184
772Q-L3117B10-01	HAITI	INDELUZ	185
772Q-L3117B10-02	HAITI	INDELUZ	185
772Q-L3117B10-03	HAITI	INDELUZ	185

REF.	FAM.	BRAND	PAG.
772Q-L3117B1D-01	HAITI	INDELUZ	185
772Q-L3117B1D-02	HAITI	INDELUZ	185
772Q-L3117B1D-03	HAITI	INDELUZ	185
772Q-L3117B1M-01	HAITI	INDELUZ	185
772Q-L3117B1M-02	HAITI	INDELUZ	185
772Q-L3117B1M-03	HAITI	INDELUZ	185
772Q-L3317B1O-01	HAITI	INDELUZ	185
772Q-L3317B1O-02	HAITI	INDELUZ	185
772Q-L3317B1O-03	HAITI	INDELUZ	185
772Q-L3317B1D-01	HAITI	INDELUZ	185
772Q-L3317B1D-02	HAITI	INDELUZ	185
772Q-L3317B1D-03	HAITI	INDELUZ	185
772Q-L3317B1M-01	HAITI	INDELUZ	185
772Q-L3317B1M-02	HAITI	INDELUZ	185
772Q-L3317B1M-03	HAITI	INDELUZ	185
772R-L3117B2O-01	HAITI	INDELUZ	185
772R-L3117B2O-02	HAITI	INDELUZ	185
772R-L3117B2O-03	HAITI	INDELUZ	185
772R-L3117B2D-01	HAITI	INDELUZ	185
772R-L3117B2D-02	HAITI	INDELUZ	185
772R-L3117B2D-03	HAITI	INDELUZ	185
772R-L3117B2M-01	HAITI	INDELUZ	185
772R-L3117B2M-02	HAITI	INDELUZ	185
772R-L3117B2M-03	HAITI	INDELUZ	185
772R-L3317B2O-01	HAITI	INDELUZ	185
772R-L3317B2O-02	HAITI	INDELUZ	185
772R-L3317B2O-03	HAITI	INDELUZ	185
772R-L3317B2D-01	HAITI	INDELUZ	185
772R-L3317B2D-02	HAITI	INDELUZ	185
772R-L3317B2D-03	HAITI	INDELUZ	185
772R-L3317B2M-01	HAITI	INDELUZ	185
772R-L3317B2M-02	HAITI	INDELUZ	185
772R-L3317B2M-03	HAITI	INDELUZ	185
780A-	NIX	INDELUZ	113
780A-G23X1D-01	NIX	INDELUZ	252
780A-G23X1D-02	NIX	INDELUZ	252
780A-G23X1D-45	NIX	INDELUZ	252
780A-G23X1D-48	NIX	INDELUZ	252
780A-G42X1B-02	NIX	INDELUZ	252
780A-G42X1B-21	NIX	INDELUZ	252
780A-G42X1B-45	NIX	INDELUZ	252
780A-G42X1B-48	NIX	INDELUZ	252
780B-	NIX	INDELUZ	113
780B-G23X1D-01	NIX	INDELUZ	252
780B-G23X1D-02	NIX	INDELUZ	252
780B-G23X1D-45	NIX	INDELUZ	252
780B-G23X1D-48	NIX	INDELUZ	252
780B-G42X1B-02	NIX	INDELUZ	252
780B-G42X1B-21	NIX	INDELUZ	252
780B-G42X1B-45	NIX	INDELUZ	252
780B-G42X1B-48	NIX	INDELUZ	252
780E-	NIX	INDELUZ	113
780E-G23X1D-01	NIX	INDELUZ	252
780E-G23X1D-02	NIX	INDELUZ	252
780E-G23X1D-45	NIX	INDELUZ	252
780E-G23X1D-48	NIX	INDELUZ	252
780E-G42X1B-02	NIX	INDELUZ	252

REF.	FAM.	BRAND	PAG.
780F-G42X1B-21	NIX	INDELUZ	252
780F-G42X1B-45	NIX	INDELUZ	252
780F-G42X1B-48	NIX	INDELUZ	252
780F-	NIX	INDELUZ	113
780F-G23X1D-01	NIX	INDELUZ	252
780F-G23X1D-02	NIX	INDELUZ	252
780F-G23X1D-45	NIX	INDELUZ	252
780F-G23X1D-48	NIX	INDELUZ	252
780F-G42X1B-02	NIX	INDELUZ	252
780F-G42X1B-21	NIX	INDELUZ	252
780F-G42X1B-45	NIX	INDELUZ	252
780F-G42X1B-48	NIX	INDELUZ	252
781B-	CARPO	INDELUZ	106
781B-G23X1D-01	CARPO	INDELUZ	254
781B-G42X1B-01	CARPO	INDELUZ	254
791A-L0112A-04	ARLEN	DOPO	500
791B-L0112A-04	ARLEN	DOPO	608
793A-G21X1A-01	ESTEL	DOPO	524
793A-G21X1A-02	ESTEL	DOPO	524
793A-G21X1A-03	ESTEL	DOPO	524
796A-L3110I-01	DUBE	INDELUZ	172
796A-L3110I-02	DUBE	INDELUZ	172
796B-L3110I-01	DUBE	INDELUZ	172
796B-L3110I-02	DUBE	INDELUZ	172
798B-	LEN	INDELUZ	119
798B-G21X1B-01	LEN	INDELUZ	248
798C-	LEN	INDELUZ	119
798C-G21X1B-01	LEN	INDELUZ	248
801A-L3148B-01	BILOG	INDELUZ	130
801A-L3148B-02	BILOG	INDELUZ	130
801A-L31RDB-01	BILOG	INDELUZ	130
801A-L31RDB-02	BILOG	INDELUZ	130
801A-L3348B-01	BILOG	INDELUZ	130
801A-L3348B-02	BILOG	INDELUZ	130
801A-L33RDB-01	BILOG	INDELUZ	130
801A-L33RDB-02	BILOG	INDELUZ	130
801B-L31A3B-01	BILOG	INDELUZ	130
801B-L31A3B-02	BILOG	INDELUZ	130
801B-L31RDB-01	BILOG	INDELUZ	130
801B-L31RDB-02	BILOG	INDELUZ	130
801B-L33A3B-01	BILOG	INDELUZ	130
801B-L33A3B-02	BILOG	INDELUZ	130
801B-L33RDB-01	BILOG	INDELUZ	130
801B-L33RDB-02	BILOG	INDELUZ	130
801C-L3148B-01	BILOG	INDELUZ	132
801C-L3148B-02	BILOG	INDELUZ	132
801C-L31RDB-01	BILOG	INDELUZ	132
801C-L31RDB-02	BILOG	INDELUZ	132
801C-L3348B-01	BILOG	INDELUZ	132
801C-L3348B-02	BILOG	INDELUZ	132
801C-L33RDB-01	BILOG	INDELUZ	132
801C-L33RDB-02	BILOG	INDELUZ	132
801D-L31A3B-01	BILOG	INDELUZ	132
801D-L31A3B-02	BILOG	INDELUZ	132
801D-L31RDB-01	BILOG	INDELUZ	132
801D-L31RDB-02	BILOG	INDELUZ	132
801D-L33A3B-01	BILOG	INDELUZ	132

REF.	FAM.	BRAND	PAG.
801D-L33A3B-02	BILOG	INDELUZ	132
801D-L33RDB-01	BILOG	INDELUZ	132
801D-L33RDB-02	BILOG	INDELUZ	132
803A-L3135B-01	ENIGMA	INDELUZ	183
803A-L3135B-02	ENIGMA	INDELUZ	183
803A-L3335B-01	ENIGMA	INDELUZ	183
803A-L3335B-02	ENIGMA	INDELUZ	183
803B-L4125B6F-01	ENIGMA	INDELUZ	182
803B-L4125B6F-02	ENIGMA	INDELUZ	182
805A-L3115B-01	BUIS	INDELUZ	124
805A-L3115B-02	BUIS	INDELUZ	124
805A-L3115B-03	BUIS	INDELUZ	124
805A-L3315B-01	BUIS	INDELUZ	124
805A-L3315B-02	BUIS	INDELUZ	124
805A-L3315B-03	BUIS	INDELUZ	124
805B-L3125B-01	BUIS	INDELUZ	124
805B-L3125B-02	BUIS	INDELUZ	124
805B-L3125B-03	BUIS	INDELUZ	124
805B-L3325B-01	BUIS	INDELUZ	124
805B-L3325B-02	BUIS	INDELUZ	124
805B-L3325B-03	BUIS	INDELUZ	124
805C-L3135B-01	BUIS	INDELUZ	124
805C-L3135B-02	BUIS	INDELUZ	124
805C-L3135B-03	BUIS	INDELUZ	124
805C-L3335B-01	BUIS	INDELUZ	124
805C-L3335B-02	BUIS	INDELUZ	124
805C-L3335B-03	BUIS	INDELUZ	124
806A-L3118R-01	VALGUS	INDELUZ	122
806A-L3118Z-01	VALGUS	INDELUZ	122
806A-L31RCA-01	VALGUS	INDELUZ	122
806A-L3318R-01	VALGUS	INDELUZ	122
806A-L3318Z-01	VALGUS	INDELUZ	122
806A-L33RCA-01	VALGUS	INDELUZ	122
806B-L31RCB-01	VALGUS	INDELUZ	122
806B-L33RCB-01	VALGUS	INDELUZ	122
809A-L3844B40-01-01	SIGMA	INDELUZ	155
809A-L3844B40-01-02	SIGMA	INDELUZ	155
809A-L3844B40-03-01	SIGMA	INDELUZ	155
809A-L3844B40-03-02	SIGMA	INDELUZ	155
809A-L3844B4D-01-01	SIGMA	INDELUZ	155
809A-L3844B4D-01-02	SIGMA	INDELUZ	155
809A-L3844B4D-03-01	SIGMA	INDELUZ	155
809A-L3844B4D-03-02	SIGMA	INDELUZ	155
809A-L3944B40-01-01	SIGMA	INDELUZ	155
809A-L3944B40-01-02	SIGMA	INDELUZ	155
809A-L3944B40-03-01	SIGMA	INDELUZ	155
809A-L3944B40-03-02	SIGMA	INDELUZ	155
809A-L3944B4D-01-01	SIGMA	INDELUZ	155
809A-L3944B4D-01-02	SIGMA	INDELUZ	155
809A-L3944B4D-03-01	SIGMA	INDELUZ	155
809A-L3944B4D-03-02	SIGMA	INDELUZ	155
809A-L4044B40-01-01	SIGMA	INDELUZ	155
809A-L4044B40-01-02	SIGMA	INDELUZ	155
809A-L4044B40-03-01	SIGMA	INDELUZ	155
809A-L4044B40-03-02	SIGMA	INDELUZ	155
809A-L4044B4D-01-01	SIGMA	INDELUZ	155
809A-L4044B4D-01-02	SIGMA	INDELUZ	155

REF.	FAM.	BRAND	PAG.
809A-L4044B4D-03-01	SIGMA	INDELUZ	155
809A-L4044B4D-03-02	SIGMA	INDELUZ	155
809B-L3857B40-01-01	SIGMA	INDELUZ	155
809B-L3857B40-01-02	SIGMA	INDELUZ	155
809B-L3857B40-03-01	SIGMA	INDELUZ	155
809B-L3857B40-03-02	SIGMA	INDELUZ	155
809B-L3857B4D-01-01	SIGMA	INDELUZ	155
809B-L3857B4D-01-02	SIGMA	INDELUZ	155
809B-L3857B4D-03-01	SIGMA	INDELUZ	155
809B-L3857B4D-03-02	SIGMA	INDELUZ	155
809B-L3957B40-01-01	SIGMA	INDELUZ	155
809B-L3957B40-01-02	SIGMA	INDELUZ	155
809B-L3957B40-03-01	SIGMA	INDELUZ	155
809B-L3957B40-03-02	SIGMA	INDELUZ	155
809B-L3957B4D-01-01	SIGMA	INDELUZ	155
809B-L3957B4D-01-02	SIGMA	INDELUZ	155
809B-L3957B4D-03-01	SIGMA	INDELUZ	155
809B-L3957B4D-03-02	SIGMA	INDELUZ	155
809B-L4057B40-01-01	SIGMA	INDELUZ	155
809B-L4057B40-01-02	SIGMA	INDELUZ	155
809B-L4057B40-03-01	SIGMA	INDELUZ	155
809B-L4057B40-03-02	SIGMA	INDELUZ	155
809B-L4057B4D-01-01	SIGMA	INDELUZ	155
809B-L4057B4D-01-02	SIGMA	INDELUZ	155
809B-L4057B4D-03-01	SIGMA	INDELUZ	155
809B-L4057B4D-03-02	SIGMA	INDELUZ	155
809C-L3806B40-01-01	SIGMA	INDELUZ	151
809C-L3806B40-01-02	SIGMA	INDELUZ	151
809C-L3806B40-03-01	SIGMA	INDELUZ	151
809C-L3806B40-03-02	SIGMA	INDELUZ	151
809C-L3806B4M-01-01	SIGMA	INDELUZ	151
809C-L3806B4M-01-02	SIGMA	INDELUZ	151
809C-L3806B4M-03-01	SIGMA	INDELUZ	151
809C-L3806B4M-03-02	SIGMA	INDELUZ	151
809C-L3906B40-01-01	SIGMA	INDELUZ	151
809C-L3906B40-01-02	SIGMA	INDELUZ	151
809C-L3906B40-03-01	SIGMA	INDELUZ	151
809C-L3906B40-03-02	SIGMA	INDELUZ	151
809C-L3906B4M-01-01	SIGMA	INDELUZ	151
809C-L3906B4M-01-02	SIGMA	INDELUZ	151
809C-L3906B4M-03-01	SIGMA	INDELUZ	151
809C-L3906B4M-03-02	SIGMA	INDELUZ	151
809C-L4006B40-01-01	SIGMA	INDELUZ	151
809C-L4006B40-01-02	SIGMA	INDELUZ	151
809C-L4006B40-03-01	SIGMA	INDELUZ	151
809C-L4006B40-03-02	SIGMA	INDELUZ	151
809C-L4006B4M-01-01	SIGMA	INDELUZ	151
809C-L4006B4M-01-02	SIGMA	INDELUZ	151
809C-L4006B4M-03-01	SIGMA	INDELUZ	151
809C-L4006B4M-03-02	SIGMA	INDELUZ	151
809D-L3813B40-01-01	SIGMA	INDELUZ	151
809D-L3813B40-01-02	SIGMA	INDELUZ	151
809D-L3813B40-03-01	SIGMA	INDELUZ	151
809D-L3813B40-03-02	SIGMA	INDELUZ	151
809D-L3813B4M-01-01	SIGMA	INDELUZ	151
809D-L3813B4M-01-02	SIGMA	INDELUZ	151
809D-L3813B4M-03-01	SIGMA	INDELUZ	151

REF.	FAM.	BRAND	PAG.
809H-L3925B40-01-02	SIGMA	INDELUZ	153
809H-L3925B40-03-01	SIGMA	INDELUZ	153
809H-L3925B40-03-02	SIGMA	INDELUZ	153
809H-L3925B4D-01-01	SIGMA	INDELUZ	153
809H-L3925B4D-01-02	SIGMA	INDELUZ	153
809H-L3925B4D-03-01	SIGMA	INDELUZ	153
809H-L3925B4D-03-02	SIGMA	INDELUZ	153
809H-L3925B4M-01-01	SIGMA	INDELUZ	153
809H-L3925B4M-01-02	SIGMA	INDELUZ	153
809H-L3925B4M-03-01	SIGMA	INDELUZ	153
809H-L3925B4M-03-02	SIGMA	INDELUZ	153
809H-L4025B40-01-01	SIGMA	INDELUZ	153
809H-L4025B40-01-02	SIGMA	INDELUZ	153
809H-L4025B40-03-01	SIGMA	INDELUZ	153
809H-L4025B40-03-02	SIGMA	INDELUZ	153
809H-L4025B4D-01-01	SIGMA	INDELUZ	153
809H-L4025B4D-01-02	SIGMA	INDELUZ	153
809H-L4025B4D-03-01	SIGMA	INDELUZ	153
809H-L4025B4D-03-02	SIGMA	INDELUZ	153
809H-L4025B4M-01-01	SIGMA	INDELUZ	153
809H-L4025B4M-01-02	SIGMA	INDELUZ	153
809H-L4025B4M-03-01	SIGMA	INDELUZ	153
809H-L4025B4M-03-02	SIGMA	INDELUZ	153
818C-L3808B30-01	JANO	INDELUZ	249
818C-L3808B3D-01	JANO	INDELUZ	249
818C-L3908B30-01	JANO	INDELUZ	249
818C-L3908B3D-01	JANO	INDELUZ	249
818C-L4008B30-01	JANO	INDELUZ	249
818C-L4008B3D-01	JANO	INDELUZ	249
835A-L4125B2F-01-01	HIDRA	INDELUZ	178
835A-L4125B2F-01-02	HIDRA	INDELUZ	178
835A-L4125B2F-01-47	HIDRA	INDELUZ	178
835A-L4125B2F-02-02	HIDRA	INDELUZ	178
835A-L4125B2F-02-47	HIDRA	INDELUZ	178
835A-L4125B3F-01-01	HIDRA	INDELUZ	178
835A-L4125B3F-01-02	HIDRA	INDELUZ	178
835A-L4125B3F-01-47	HIDRA	INDELUZ	178
835A-L4125B3F-02-02	HIDRA	INDELUZ	178
835A-L4125B3F-02-47	HIDRA	INDELUZ	178
835A-L4125B6F-01-01	HIDRA	INDELUZ	178
835A-L4125B6F-01-47	HIDRA	INDELUZ	178
835B-L4125B2F-01-01	HIDRA	INDELUZ	128
835B-L4125B2F-01-02	HIDRA	INDELUZ	128
835B-L4125B2F-01-47	HIDRA	INDELUZ	128
835B-L4125B2F-02-02	HIDRA	INDELUZ	128
835B-L4125B2F-02-47	HIDRA	INDELUZ	128
835B-L4125B3F-01-01	HIDRA	INDELUZ	128
835B-L4125B3F-01-02	HIDRA	INDELUZ	128
835B-L4125B3F-01-47	HIDRA	INDELUZ	128
835B-L4125B3F-02-02	HIDRA	INDELUZ	128
835B-L4125B3F-02-47	HIDRA	INDELUZ	128
835B-L4125B6F-01-01	HIDRA	INDELUZ	128
835B-L4125B6F-01-02	HIDRA	INDELUZ	128
835B-L4125B6F-01-47	HIDRA	INDELUZ	128

REF.	FAM.	BRAND	PAG.
835B-L4125B6F-02-02	HIDRA	INDELUZ	128
835B-L4125B6F-02-47	HIDRA	INDELUZ	128
835C-L4125B2F-01-01	HIDRA	INDELUZ	176
835C-L4125B2F-01-02	HIDRA	INDELUZ	176
835C-L4125B2F-01-47	HIDRA	INDELUZ	176
835C-L4125B2F-02-02	HIDRA	INDELUZ	176
835C-L4125B2F-02-47	HIDRA	INDELUZ	176
835C-L4125B3F-01-01	HIDRA	INDELUZ	176
835C-L4125B3F-01-02	HIDRA	INDELUZ	176
835C-L4125B3F-01-47	HIDRA	INDELUZ	176
835C-L4125B3F-02-02	HIDRA	INDELUZ	176
835C-L4125B3F-02-47	HIDRA	INDELUZ	176
835C-L4125B6F-01-01	HIDRA	INDELUZ	176
835C-L4125B6F-01-02	HIDRA	INDELUZ	176
835C-L4125B6F-01-47	HIDRA	INDELUZ	176
835C-L4125B6F-02-02	HIDRA	INDELUZ	176
835C-L4125B6F-02-47	HIDRA	INDELUZ	176
835D-L4125B2F-01-01	HIDRA	INDELUZ	176
835D-L4125B2F-01-02	HIDRA	INDELUZ	176
835D-L4125B2F-01-47	HIDRA	INDELUZ	176
835D-L4125B2F-02-02	HIDRA	INDELUZ	176
835D-L4125B2F-02-47	HIDRA	INDELUZ	176
835D-L4125B3F-01-01	HIDRA	INDELUZ	176
835D-L4125B3F-01-02	HIDRA	INDELUZ	176
835D-L4125B3F-01-47	HIDRA	INDELUZ	176
835D-L4125B3F-02-02	HIDRA	INDELUZ	176
835D-L4125B3F-02-47	HIDRA	INDELUZ	176
835E-L4125B2F-01-01	HIDRA	INDELUZ	126
835E-L4125B2F-01-02	HIDRA	INDELUZ	126
835E-L4125B2F-01-47	HIDRA	INDELUZ	126
835E-L4125B2F-02-02	HIDRA	INDELUZ	126
835E-L4125B2F-02-47	HIDRA	INDELUZ	126
835E-L4125B3F-01-01	HIDRA	INDELUZ	126
835E-L4125B3F-01-02	HIDRA	INDELUZ	126
835E-L4125B3F-01-47	HIDRA	INDELUZ	126
835E-L4125B3F-02-02	HIDRA	INDELUZ	126
835E-L4125B3F-02-47	HIDRA	INDELUZ	126
835E-L4125B6F-01-01	HIDRA	INDELUZ	126
835E-L4125B6F-01-02	HIDRA	INDELUZ	126
835E-L4125B6F-01-47	HIDRA	INDELUZ	126
835E-L4125B6F-02-02	HIDRA	INDELUZ	126
835E-L4125B6F-02-47	HIDRA	INDELUZ	126
842A-L10103B-01	TOSCANA	EXO	335
842A-L10103B-02	TOSCANA	EXO	335
842A-L10103B-35	TOSCANA	EXO	335
844A-G05X1A-01	VALAN	EXO	377
844A-G05X1A-BL	VALAN	EXO	377
844A-G05X1A-MK	VALAN	EXO	377
846B-G05X1A-01	VALAN	EXO	321
846B-G05X1A-BL	VALAN	EXO	321
846B-G05X1A-MK	VALAN	EXO	321
846C-G05X1A-01	VALAN	EXO	444

REF.	FAM.	BRAND	PAG.
846C-G05X1A-BL	VALAN	EXO	444
846C-G05X1A-MK	VALAN	EXO	444
846D-G05X1A-01	VALAN	EXO	444
846D-G05X1A-BL	VALAN	EXO	444
846D-G05X1A-MK	VALAN	EXO	444
847A-L0107B-01	ABAR	DOPO	518
847A-L0107B-02	ABAR	DOPO	518
847A-L0107B-04	ABAR	DOPO	518
848A-L0109A-04	ADAY	DOPO	496
848B-L0118A-04	ADAY	DOPO	606
848C-L0118A-04	ADAY	DOPO	606
851A-L3107A-04	NAGORE	DOPO	566
851B-L3107A-04	NAGORE	DOPO	566
853A-L01X1K-04	SOLEI	DOPO	636
853B-L01X1K-04	SOLEI	DOPO	636
854A-L0104A-01	LARA	DOPO	541
854A-L0104A-04	LARA	DOPO	541
854B-L0104A-01	LARA	DOPO	541
854B-L0104A-04	LARA	DOPO	541
855A-G05X1A-01-SA	DIAGONAL	EXO	423
855A-G05X1A-02-SB	DIAGONAL	EXO	423
855A-G05X1A-37-SM	DIAGONAL	EXO	423
855B-G05X1A-01-SA	DIAGONAL	EXO	422
855B-G05X1A-02-SB	DIAGONAL	EXO	422
855B-G05X1A-37-SM	DIAGONAL	EXO	422
855C-G05X1A-01-SA	DIAGONAL	EXO	422
855C-G05X1A-02-SB	DIAGONAL	EXO	422
855C-G05X1A-37-SM	DIAGONAL	EXO	422
855D-G05X1A-01-SA	DIAGONAL	EXO	376
855D-G05X1A-02-SB	DIAGONAL	EXO	376
855D-G05X1A-37-SM	DIAGONAL	EXO	376
855E-G05X1A-01-SA	DIAGONAL	EXO	306
855E-G05X1A-02-SB	DIAGONAL	EXO	306
855E-G05X1A-37-SM	DIAGONAL	EXO	306
857A-G05X1A-58	NELL	EXO	474
857B-G05X1A-58	NELL	EXO	474
857C-L3102L-58	NELL	EXO	474
857C-L3106B-58	NELL	EXO	474
857D-G05X1A-58	NELL	EXO	473
857H-L3106B-58	NELL	EXO	472
858A-G05X1B-02	PORTOFINO	DOPO	644
858AK-632H-01	PORTOFINO	DOPO	644
858AK-632J-01	PORTOFINO	DOPO	644
859A-G05X1A-35-RA	CORA	EXO	386
859A-G05X1A-35-RB	CORA	EXO	386
859A-G05X1A-35-RC	CORA	EXO	386
859B-G05X1A-01-RA	CORA	EXO	428
859B-G05X1A-02-RB	CORA	EXO	428
859C-G05X1A-01-RA	CORA	EXO	428
859C-G05X1A-02-RB	CORA	EXO	428
859D-G05X1A-01-RA	CORA	EXO	312
859D-G05X1A-02-RB	CORA	EXO	312
906A-G21X1A-01	TANIA	EXO	303
906A-G21X1A-02	TANIA	EXO	303
906A-G21X1A-37	TANIA	EXO	303
906A-G21X1A-47	TANIA	EXO	303
906A-G21X1A-AG	TANIA	EXO	303

REF.	FAM.	BRAND	PAG.
906B-G21X1A-01	TANIA	EXO	372
906B-G21X1A-02	TANIA	EXO	372
906B-G21X1A-37	TANIA	EXO	372
906B-G21X1A-47	TANIA	EXO	372
906B-G21X1A-AG	TANIA	EXO	372
906C-G21X1A-01	TANIA	EXO	372
906C-G21X1A-02	TANIA	EXO	372
906C-G21X1A-37	TANIA	EXO	372
906C-G21X1A-47	TANIA	EXO	372
906C-G21X1A-AG	TANIA	EXO	372
906D-L31H1B-01	TANIA	EXO	302
906D-L31H1B-02	TANIA	EXO	302
906D-L31H1B-37	TANIA	EXO	302
906D-L31H1B-47	TANIA	EXO	302
906D-L31H1B-AG	TANIA	EXO	302
906E-L3104B-01	TANIA	EXO	374
906E-L3104B-02	TANIA	EXO	374
906E-L3104B-37	TANIA	EXO	374
906E-L3104B-47	TANIA	EXO	374
906E-L3104B-AG	TANIA	EXO	374
906F-L3104B-01	TANIA	EXO	374
906F-L3104B-02	TANIA	EXO	374
906F-L3104B-37	TANIA	EXO	374
906F-L3104B-47	TANIA	EXO	374
906F-L3104B-AG	TANIA	EXO	374
906G-L3104B-01	TANIA	EXO	418
906G-L3104B-02	TANIA	EXO	418
906G-L3104B-37	TANIA	EXO	418
906G-L3104B-47	TANIA	EXO	418
906G-L3104B-AG	TANIA	EXO	418
906H-G21X1A-01	TANIA	EXO	370
906H-G21X1A-02	TANIA	EXO	370
906H-G21X1A-37	TANIA	EXO	370
906H-G21X1A-47	TANIA	EXO	370
906H-G21X1A-AG	TANIA	EXO	370
906J-G21X1A-01	TANIA	EXO	370
906J-G21X1A-02	TANIA	EXO	370
906J-G21X1A-37	TANIA	EXO	370
906J-G21X1A-47	TANIA	EXO	370
906J-G21X1A-AG	TANIA	EXO	370
906K-G21X1A-01	TANIA	EXO	370
906K-G21X1A-02	TANIA	EXO	370
906K-G21X1A-37	TANIA	EXO	370
906K-G21X1A-47	TANIA	EXO	370
906K-G21X1A-AG	TANIA	EXO	370
907A-G05X1A-02-CB	MONTECARLO	EXO	445
907B-G05X1A-02-CB	MONTECARLO	EXO	324
908A-L0112B-RA	VORADA	EXO	390
908A-L0112B-RB	VORADA	EXO	390
908A-L0112B-RC	VORADA	EXO	390
908B-L0125B-RA	VORADA	EXO	390
908B-L0125B-RB	VORADA	EXO	390
908B-L0125B-RC	VORADA	EXO	390
908C-L0129B-RA	VORADA	EXO	390
908C-L0129B-RB	VORADA	EXO	390
908C-L0129B-RC	VORADA	EXO	390
908D-L0112B-RA	VORADA	EXO	391

REF.	FAM.	BRAND	PAG.
908D-L012B-RB	VORADA	EXO	391
908D-L012B-RC	VORADA	EXO	391
908E-L0125B-RA	VORADA	EXO	391
908E-L0125B-RB	VORADA	EXO	391
908E-L0125B-RC	VORADA	EXO	391
908F-L0129B-RA	VORADA	EXO	391
908F-L0129B-RB	VORADA	EXO	391
908F-L0129B-RC	VORADA	EXO	391
908G-G05XIA-35-RA	AMSTERDAM	EXO	310
908G-G05XIA-35-RB	AMSTERDAM	EXO	310
908G-G05XIA-35-RC	AMSTERDAM	EXO	310
909A-G05XIA-01-9BCA	AMSTERDAM	EXO	426
909A-G05XIA-01-9BCB	AMSTERDAM	EXO	426
909A-G05XIA-01-9BCG	AMSTERDAM	EXO	426
909A-G05XIA-02-9BCA	AMSTERDAM	EXO	426
909A-G05XIA-02-9BCB	AMSTERDAM	EXO	426
909A-G05XIA-02-9BCG	AMSTERDAM	EXO	426
909B-G05XIA-01-9CCA	AMSTERDAM	EXO	426
909B-G05XIA-01-9CCB	AMSTERDAM	EXO	426
909B-G05XIA-01-9CCG	AMSTERDAM	EXO	426
909B-G05XIA-02-9CCA	AMSTERDAM	EXO	426
909B-G05XIA-02-9CCB	AMSTERDAM	EXO	426
909B-G05XIA-02-9CCG	AMSTERDAM	EXO	426
909C-G05XIA-35-CA	AMSTERDAM	EXO	310
909C-G05XIA-35-CB	AMSTERDAM	EXO	310
909C-G05XIA-35-CG	AMSTERDAM	EXO	310
912A-L0101F-30	BERNA	DOPO	552
914B-L0103L-01	LITTA	DOPO	640
914B-L0103L-02	LITTA	DOPO	640
916A-L0103K-04	COMO	DOPO	635
916B-L0103K-04	COMO	DOPO	634
916C-L0103K-04	COMO	DOPO	635
917A-G05XIA-02-CA	SINTRA	EXO	440
917B-G05XIA-02-CA	SINTRA	EXO	440
920A-L1440F-03	WALK	CRISTHER	781
920A-L3122B-03	WALK	CRISTHER	780
920A-L3322B-03	WALK	CRISTHER	780
920B-L3122B-03	WALK	CRISTHER	780
920B-L3322B-03	WALK	CRISTHER	780
920C-L1480F-03	WALK	CRISTHER	781
920C-L3147B-03	WALK	CRISTHER	780
920C-L3347B-03	WALK	CRISTHER	780
920D-L3147B-03	WALK	CRISTHER	780
920D-L3347B-03	WALK	CRISTHER	780
920G-L3112B-30	WALK	CRISTHER	782
920G-L3312B-30	WALK	CRISTHER	782
920H-L3124B-30	WALK	CRISTHER	782
920H-L3324B-30	WALK	CRISTHER	782
920M-L1440F-30	WALK	CRISTHER	783
920M-L3122B-30	WALK	CRISTHER	782
920M-L3322B-30	WALK	CRISTHER	782
920N-L3122B-30	WALK	CRISTHER	782
920N-L3322B-30	WALK	CRISTHER	782
920O-L1480F-30	WALK	CRISTHER	783
920O-L3147B-30	WALK	CRISTHER	782
920O-L3347B-30	WALK	CRISTHER	782
920P-L3147B-30	WALK	CRISTHER	782

REF.	FAM.	BRAND	PAG.
920P-L3347B-30	WALK	CRISTHER	782
922A-L3108B-04	DADO	CRISTHER	798
922A-L3308B-04	DADO	CRISTHER	798
922B-L3108B-04	DADO	CRISTHER	798
922B-L3308B-04	DADO	CRISTHER	798
922C-L3114B-04	DADO	CRISTHER	799
922C-L31RDB-04	DADO	CRISTHER	799
922C-L3314B-04	DADO	CRISTHER	799
922C-L33RDB-04	DADO	CRISTHER	799
922D-L3114B-04	DADO	CRISTHER	799
922D-L31RDB-04	DADO	CRISTHER	799
922D-L3314B-04	DADO	CRISTHER	799
922D-L33RDB-04	DADO	CRISTHER	799
923A-L3113B-04	RIMA	CRISTHER	730
923A-L3313B-04	RIMA	CRISTHER	730
923B-L3105B-04	RIMA	CRISTHER	730
923B-L3305B-04	RIMA	CRISTHER	730
926A-L3109B-80	DION	CRISTHER	816
926A-L3109B-81	DION	CRISTHER	816
926A-L3109B-82	DION	CRISTHER	816
926A-L3109B-83	DION	CRISTHER	816
926B-L3109B-80	DION	CRISTHER	816
926B-L3109B-81	DION	CRISTHER	816
926B-L3109B-82	DION	CRISTHER	816
926B-L3109B-83	DION	CRISTHER	816
926C-L3109B-80	DION	CRISTHER	816
926C-L3109B-81	DION	CRISTHER	816
926C-L3109B-82	DION	CRISTHER	816
926C-L3109B-83	DION	CRISTHER	712
926D-L3109B-80	DION	CRISTHER	712
926D-L3109B-81	DION	CRISTHER	712
926D-L3109B-82	DION	CRISTHER	712
926D-L3109B-83	DION	CRISTHER	712
929A-L3109B-01	DAIN	CRISTHER	736
929A-L3109B-02	DAIN	CRISTHER	736
929A-L3109B-03	DAIN	CRISTHER	736
929A-L3109B-90	DAIN	CRISTHER	736
929B-L3105B-01	DAIN	CRISTHER	736
929B-L3105B-02	DAIN	CRISTHER	736
929B-L3105B-03	DAIN	CRISTHER	736
929B-L3105B-90	DAIN	CRISTHER	736
929C-L3105B-02	DAIN	CRISTHER	818
929C-L3105B-03	DAIN	CRISTHER	818
929C-L3105B-90	DAIN	CRISTHER	818
929D-L3105B-02	DAIN	CRISTHER	818
929D-L3105B-03	DAIN	CRISTHER	818
929D-L3105B-90	DAIN	CRISTHER	818
932A-L3133B-02	AURA	CRISTHER	822
932A-L3133B-90	AURA	CRISTHER	822
932A-L31RDB-02	AURA	CRISTHER	822
932A-L31RDB-90	AURA	CRISTHER	822
932A-L3333B-02	AURA	CRISTHER	822
932A-L3333B-90	AURA	CRISTHER	822
932A-L33RDB-02	AURA	CRISTHER	822
932A-L33RDB-90	AURA	CRISTHER	822
932B-L3133B-02	AURA	CRISTHER	823
932B-L3133B-90	AURA	CRISTHER	823

REF.	FAM.	BRAND	PAG.
932B-L31RDB-02	AURA	CRISTHER	823
932B-L31RDB-90	AURA	CRISTHER	823
932B-L3333B-02	AURA	CRISTHER	823
932B-L3333B-90	AURA	CRISTHER	823
932B-L33RDB-02	AURA	CRISTHER	823
932B-L33RDB-90	AURA	CRISTHER	823
932C-L3114B-02	AURA	CRISTHER	822
932C-L3114B-90	AURA	CRISTHER	822
932C-L31RDB-02	AURA	CRISTHER	822
932C-L31RDB-90	AURA	CRISTHER	822
932C-L3314B-02	AURA	CRISTHER	822
932C-L3314B-90	AURA	CRISTHER	822
932C-L33RDB-02	AURA	CRISTHER	822
932C-L33RDB-90	AURA	CRISTHER	822
932D-L3125B-02	AURA	CRISTHER	822
932D-L3125B-90	AURA	CRISTHER	822
932D-L31RDB-02	AURA	CRISTHER	822
932D-L31RDB-90	AURA	CRISTHER	822
932D-L3325B-02	AURA	CRISTHER	822
932D-L3325B-90	AURA	CRISTHER	822
932D-L33RDB-02	AURA	CRISTHER	822
932D-L33RDB-90	AURA	CRISTHER	822
935A-L3105B-02	ARM	EXO	322
935B-L3105B-02	ARM	EXO	322
941A-L0106A-04	ODIN	DOPO	613
941B-L0106A-04	ODIN	DOPO	613
945A-L3110A-50	TWIST	EXO	408
945B-L3111A-50	TWIST	EXO	408
945C-L3110A-50	TWIST	EXO	354
945D-L3110A-50	TWIST	EXO	354
945E-L3111A-50	TWIST	EXO	408
947A-L3104A-01	STORM	DOPO	525
947A-L3104A-02	STORM	DOPO	525
947A-L3104A-03	STORM	DOPO	525
947B-L3109A-01	STORM	DOPO	525
947B-L3109A-02	STORM	DOPO	525
947B-L3109A-03	STORM	DOPO	525
947C-L3111A-01	STORM	DOPO	525
947C-L3111A-02	STORM	DOPO	525
947C-L3111A-03	STORM	DOPO	525
948A-L3110A-01	MIST	DOPO	546
948A-L3110A-02	MIST	DOPO	546
948A-L3110A-03	MIST	DOPO	546
949A-L3111A-01	WIND	DOPO	544
949A-L3111A-02	WIND	DOPO	544
949A-L3111A-03	WIND	DOPO	544
950A-L1002A-01	RAIN	DOPO	559
950A-L1002A-02	RAIN	DOPO	559
950A-L1002A-03	RAIN	DOPO	559
950A-L3102A-01	RAIN	DOPO	559
950A-L3102A-02	RAIN	DOPO	559
950A-L3102A-03	RAIN	DOPO	559
950B-L3102A-01	RAIN	DOPO	558
950B-L3102A-02	RAIN	DOPO	558
950B-L3102A-03	RAIN	DOPO	558
950C-L3102A-01	RAIN	DOPO	558
950C-L3102A-02	RAIN	DOPO	558

REF.	FAM.	BRAND	PAG.
950C-L3102A-03	RAIN	DOPO	558
950D-L1002A-01	RAIN	DOPO	559
950D-L1002A-02	RAIN	DOPO	559
950D-L1002A-03	RAIN	DOPO	559
950D-L3102A-01	RAIN	DOPO	559
950D-L3102A-02	RAIN	DOPO	559
950D-L3102A-03	RAIN	DOPO	559
951A-L3103A-04	SHINNY	DOPO	550
952A-L3107A-01	CLOUD	DOPO	508
952A-L3107A-04	CLOUD	DOPO	508
953A-L3108A-01	FROST	DOPO	508
953A-L3108A-04	FROST	DOPO	508
955A-L0102A-01	SKIN	EXO	330
955A-L0102A-02	SKIN	EXO	330
955A-L0102A-07	SKIN	EXO	330
955A-L0102A-14	SKIN	EXO	330
956A-G05X1A-01	TOSCA	EXO	368
956A-G05X1A-02	TOSCA	EXO	368
956A-G05X1A-06	TOSCA	EXO	368
956B-G05X1A-01	TOSCA	EXO	368
956B-G05X1A-02	TOSCA	EXO	368
956B-G05X1A-06	TOSCA	EXO	368
956C-G05X1A-01	TOSCA	EXO	300
956C-G05X1A-02	TOSCA	EXO	300
956C-G05X1A-06	TOSCA	EXO	300
956D-G05X1A-01	TOSCA	EXO	462
956D-G05X1A-02	TOSCA	EXO	462
956D-G05X1A-06	TOSCA	EXO	462
956E-G05X1A-01	TOSCA	EXO	462
956E-G05X1A-02	TOSCA	EXO	462
956E-G05X1A-06	TOSCA	EXO	462
959A-L0218B-01	TILT	EXO	448
959A-L0218B-02	TILT	EXO	448
959B-L0230B-01	TILT	EXO	448
959B-L0230B-02	TILT	EXO	448
960A-L3106B-01	BEAM	DOPO	502
960A-L3106B-02	BEAM	DOPO	502
960A-L3106B-04	BEAM	DOPO	502
960A-L3106B-90	BEAM	DOPO	502
960B-L3112B-01	BEAM	DOPO	504
960B-L3112B-02	BEAM	DOPO	504
960B-L3112B-04	BEAM	DOPO	504
960B-L3112B-90	BEAM	DOPO	504
962A-L3114B-02-W1	EYE	EXO	296
962A-L3114B-02-W2	EYE	EXO	296
962A-L3114B-02-W3	EYE	EXO	296
962B-L3114B-02-W1	EYE	EXO	296
962B-L3114B-02-W2	EYE	EXO	296
962B-L3114B-02-W3	EYE	EXO	296
962C-L3114B-02-W1	EYE	EXO	296
962C-L3114B-02-W2	EYE	EXO	296
962C-L3114B-02-W3	EYE	EXO	296
965A-G21X1A-NB	STONE	CRISTHER	714
965A-G21X1A-NN	STONE	CRISTHER	714
965A-G21X1A-NR	STONE	CRISTHER	714
965A-G21X1A-NW	STONE	CRISTHER	714
965B-G21X1A-NB	STONE	CRISTHER	714

REF.	FAM.	BRAND	PAG.
965B-G21X1A-NN	STONE	CRISTHER	714
965B-G21X1A-NR	STONE	CRISTHER	714
965B-G21X1A-NW	STONE	CRISTHER	714
965C-L3112A-NB	STONE	CRISTHER	716
965C-L3112A-NN	STONE	CRISTHER	716
965C-L3112A-NR	STONE	CRISTHER	716
965C-L3112A-NW	STONE	CRISTHER	716
965D-G21X1A-NB	STONE	CRISTHER	748
965D-G21X1A-NN	STONE	CRISTHER	748
965D-G21X1A-NR	STONE	CRISTHER	748
965D-G21X1A-NW	STONE	CRISTHER	748
965F-L3106B-NB	STONE	CRISTHER	814
965F-L3106B-NN	STONE	CRISTHER	814
965H-G21X1A-NB	STONE	CRISTHER	794
965H-G21X1A-NN	STONE	CRISTHER	794
967A-L0102A-01	G9	NX Lighting	860
967A-L0102A-02	G9	NX Lighting	860
968A-L4104A-02	R7s	NX Lighting	860
968B-L4108A-02	R7s	NX Lighting	860
968C-L4111A-02	R7s	NX Lighting	860
970A-L0206B-32	BLIZZARD	EXO	450
970B-L0208B-32	BLIZZARD	EXO	450
970D-L0215B-32	BLIZZARD	EXO	450
970E-L0218B-32	BLIZZARD	EXO	450
972D-L4106B-32	SLEET	EXO	452
972E-L4108B-32	SLEET	EXO	452
976A-L3110B-04	BUCKET	CRISTHER	710
976A-L31RCB-04	BUCKET	CRISTHER	710
976A-L3310B-04	BUCKET	CRISTHER	710
976A-L33RCB-04	BUCKET	CRISTHER	710
976B-L3110B-04	BUCKET	CRISTHER	812
976B-L31RCB-04	BUCKET	CRISTHER	812
976B-L3310B-04	BUCKET	CRISTHER	812
976B-L33RCB-04	BUCKET	CRISTHER	812
976C-L3110B-04	BUCKET	CRISTHER	812
976C-L31RCB-04	BUCKET	CRISTHER	812
976C-L3310B-04	BUCKET	CRISTHER	812
976C-L33RCB-04	BUCKET	CRISTHER	812
977A-L0103A-01	MINIMAL	EXO	328
977A-L0103A-02	MINIMAL	EXO	328
977A-L0103A-02-46	MINIMAL	EXO	328
980A-L0103H-30	NABUCO	CRISTHER	752
980B-L0104H-30	NABUCO	CRISTHER	752
980B-L0106H-30	NABUCO	CRISTHER	752
980H-L0103H-30	NABUCO	CRISTHER	758
980I-L0104H-30	NABUCO	CRISTHER	758
980I-L0106H-30	NABUCO	CRISTHER	758
982A-L3109A-02	LOOP	DOPO	495
982A-L3309A-02	LOOP	DOPO	495
982B-L3109A-02	LOOP	DOPO	598
982B-L3309A-02	LOOP	DOPO	598
982C-L3109A-02	LOOP	DOPO	598
982C-L3309A-02	LOOP	DOPO	598
983A-L41MPA-01	FALL	INDELUZ	180
983A-L41MPA-02	FALL	INDELUZ	180
984A-G05X1A-02	OXY	EXO	364
984A-G05X1A-02-27	OXY	EXO	364

REF.	FAM.	BRAND	PAG.
984A-G05X1A-32	OXY	EXO	364
984A-G05X1A-32-27	OXY	EXO	364
984A-G05X1A-47	OXY	EXO	364
984A-G05X1A-47-27	OXY	EXO	364
984B-G05X1A-02	OXY	EXO	364
984B-G05X1A-02-27	OXY	EXO	364
984B-G05X1A-32	OXY	EXO	364
984B-G05X1A-32-27	OXY	EXO	364
984B-G05X1A-47	OXY	EXO	364
984B-G05X1A-47-27	OXY	EXO	364
984C-G05X1A-02	OXY	EXO	364
984C-G05X1A-02-27	OXY	EXO	364
984C-G05X1A-32	OXY	EXO	364
984C-G05X1A-32-27	OXY	EXO	364
984C-G05X1A-47	OXY	EXO	364
984C-G05X1A-47-27	OXY	EXO	364
984D-G05X1A-02	OXY	EXO	364
984D-G05X1A-02-27	OXY	EXO	364
984D-G05X1A-32	OXY	EXO	364
984D-G05X1A-32-27	OXY	EXO	364
984D-G05X1A-47	OXY	EXO	364
984D-G05X1A-47-27	OXY	EXO	364
984E-G05X1A-02	OXY	EXO	364
984E-G05X1A-02-27	OXY	EXO	364
984E-G05X1A-32	OXY	EXO	364
984E-G05X1A-32-27	OXY	EXO	364
984E-G05X1A-47	OXY	EXO	364
984E-G05X1A-47-27	OXY	EXO	364
984F-G05X1A-02	OXY	EXO	304
984F-G05X1A-02-27	OXY	EXO	304
984F-G05X1A-32	OXY	EXO	304
984F-G05X1A-32-27	OXY	EXO	304
984F-G05X1A-47	OXY	EXO	304
984F-G05X1A-47-27	OXY	EXO	304
984H-G05X1A-02-27	OXY	EXO	366
984I-G05X1A-02-27	OXY	EXO	366
984J-G05X1A-02-27	OXY	EXO	366
984K-G05X1A-02-27	OXY	EXO	360
984K-G05X1A-02-LB	OXY	EXO	360
984L-G05X1A-02-27	OXY	EXO	360
984L-G05X1A-02-LB	OXY	EXO	360
984M-G05X1A-01-27	OXY	EXO	362
984M-G05X1A-01-LB	OXY	EXO	362
984N-G05X1A-01-27	OXY	EXO	362
984N-G05X1A-01-LB	OXY	EXO	362
984P-G05X1A-01-27	OXY	EXO	305
984P-G05X1A-01-LB	OXY	EXO	305
985A-G05X1A-02-RI	THAIS	EXO	380
985B-G05X1A-02-RI	THAIS	EXO	380
985C-G05X1A-02-RI	THAIS	EXO	380
985D-G05X1A-02-RI	THAIS	EXO	468
985E-G05X1A-02-RI	THAIS	EXO	468
985F-G05X1A-02-RI	THAIS	EXO	468
986A-G05X1A-35-CA	CLASSICAL	EXO	308
986A-G05X1A-47-CB	CLASSICAL	EXO	308
986B-G05X1A-35-CA	CLASSICAL	EXO	424
986B-G05X1A-47-CB	CLASSICAL	EXO	424

REF.	FAM.	BRAND	PAG.
986C-G05X1A-35-CA	CLASSICAL	EXO	424
986C-G05X1A-47-CB	CLASSICAL	EXO	424
987A-L0109B-01	COOPER	EXO	338
987A-L0109B-02	COOPER	EXO	338
987A-L0109B-46	COOPER	EXO	338
987A-L0109B-BR	COOPER	EXO	338
988A-L0109B-01	CIRCULAR	EXO	340
988A-L0109B-02	CIRCULAR	EXO	340
988B-L0113B-01	CIRCULAR	EXO	340
988B-L0113B-02	CIRCULAR	EXO	340
988C-L0128B-01	CIRCULAR	EXO	340
988C-L0128B-02	CIRCULAR	EXO	340
988D-L0140B-01	CIRCULAR	EXO	340
988D-L0140B-02	CIRCULAR	EXO	340
990A-G04X1A-01	MANTIS	EXO	442
992A-G04X1A-01	TAICHI	EXO	438
992A-G04X1A-02	TAICHI	EXO	438
992B-G04X1A-01	TAICHI	EXO	438
992B-G04X1A-02	TAICHI	EXO	438
995A-H20X1A-04	LUA	DOPO	614
996A-L2806C-04	TERRA	DOPO	576
996A-L3106B-04	TERRA	DOPO	576
996A-L3106B-05	TERRA	DOPO	576
996A-L3106B-90	TERRA	DOPO	576
996A-L3106C-04	TERRA	DOPO	576
996A-L3306B-04	TERRA	DOPO	576
997A-L4125B20-01	AMY	INDELUZ	274
997A-L4125B20-02	AMY	INDELUZ	274
997A-L4125B30-01	AMY	INDELUZ	274
997A-L4125B30-02	AMY	INDELUZ	274
997A-L4125B60-01	AMY	INDELUZ	274
997A-L4125B60-02	AMY	INDELUZ	274
997B-L4130B2F-01	AMY	INDELUZ	274
997B-L4130B2F-02	AMY	INDELUZ	274
997B-L4130B3F-01	AMY	INDELUZ	274
997B-L4130B3F-02	AMY	INDELUZ	274
997B-L4130B6F-01	AMY	INDELUZ	274
997B-L4130B6F-02	AMY	INDELUZ	274
998A-L3106E-02	GIBSON	CRISTHER	800
998A-L3306E-02	GIBSON	CRISTHER	800
998B-L310E-02	GIBSON	CRISTHER	800
998B-L3310E-02	GIBSON	CRISTHER	800
998C-L3106E-02	GIBSON	CRISTHER	800
998C-L3306E-02	GIBSON	CRISTHER	800
998D-L310E-02	GIBSON	CRISTHER	800
998D-L3310E-02	GIBSON	CRISTHER	800
999A-L0125A-04	FENDER	CRISTHER	840
999A-L0150A-04	FENDER	CRISTHER	840
999A-L0225A-04	FENDER	CRISTHER	840
999A-L0250A-04	FENDER	CRISTHER	840
999B-L0125A-04	FENDER	CRISTHER	840
999B-L0150A-04	FENDER	CRISTHER	840
999B-L0225A-04	FENDER	CRISTHER	840
999B-L0250A-04	FENDER	CRISTHER	840
1000A-L3009B10-01	DISC	CRISTHER	796
1000A-L3009B10-04	DISC	CRISTHER	796
1000A-L3009B30-01	DISC	CRISTHER	796

REF.	FAM.	BRAND	PAG.
1000A-L3009B30-04	DISC	CRISTHER	796
1000A-L3009B50-01	DISC	CRISTHER	796
1000A-L3009B50-04	DISC	CRISTHER	796
1000A-L3013B10-01	DISC	CRISTHER	796
1000A-L3013B10-04	DISC	CRISTHER	796
1000A-L3013B30-01	DISC	CRISTHER	796
1000A-L3013B30-04	DISC	CRISTHER	796
1000A-L3013B50-01	DISC	CRISTHER	796
1000A-L3013B50-04	DISC	CRISTHER	796
1000A-L3109B10-01	DISC	CRISTHER	796
1000A-L3109B10-04	DISC	CRISTHER	796
1000A-L3109B30-01	DISC	CRISTHER	796
1000A-L3109B30-04	DISC	CRISTHER	796
1000A-L3109B50-01	DISC	CRISTHER	796
1000A-L3109B50-04	DISC	CRISTHER	796
1000A-L3113B10-01	DISC	CRISTHER	796
1000A-L3113B10-04	DISC	CRISTHER	796
1000A-L3113B30-01	DISC	CRISTHER	796
1000A-L3113B30-04	DISC	CRISTHER	796
1000A-L3113B50-01	DISC	CRISTHER	796
1000A-L3113B50-04	DISC	CRISTHER	796
1000A-L3309B10-01	DISC	CRISTHER	796
1000A-L3309B10-04	DISC	CRISTHER	796
1000A-L3309B30-01	DISC	CRISTHER	796
1000A-L3309B30-04	DISC	CRISTHER	796
1000A-L3309B50-01	DISC	CRISTHER	796
1000A-L3309B50-04	DISC	CRISTHER	796
1000A-L3313B10-01	DISC	CRISTHER	796
1000A-L3313B10-04	DISC	CRISTHER	796
1000A-L3313B30-01	DISC	CRISTHER	796
1000A-L3313B30-04	DISC	CRISTHER	796
1000A-L3313B50-01	DISC	CRISTHER	796
1000A-L3313B50-04	DISC	CRISTHER	796
1001A-L3140A90-04	VENT	CRISTHER	838
1001A-L3140A9D-04	VENT	CRISTHER	838
1001A-L3175A90-04	VENT	CRISTHER	838
1001A-L3175A9D-04	VENT	CRISTHER	838
1001A-L3340A90-04	VENT	CRISTHER	838
1001A-L3340A9D-04	VENT	CRISTHER	838
1001A-L3375A90-04	VENT	CRISTHER	838
1001A-L3375A9D-04	VENT	CRISTHER	838
1001B-L3140A90-04	VENT	CRISTHER	838
1001B-L3140A9D-04	VENT	CRISTHER	838
1001B-L3175A90-04	VENT	CRISTHER	838
1001B-L3175A9D-04	VENT	CRISTHER	838
1001B-L3340A90-04	VENT	CRISTHER	838
1001B-L3340A9D-04	VENT	CRISTHER	838
1001B-L3375A90-04	VENT	CRISTHER	838
1001B-L3375A9D-04	VENT	CRISTHER	838
1002A-	TURT	INDELUZ	169
1003A-	ARROW	INDELUZ	170
1003B-	ARROW	INDELUZ	171
1004A-	SCOP	INDELUZ	93
1004B-	SCOP	INDELUZ	94
1005A-	QUO	INDELUZ	97
1005B-	QUO	INDELUZ	98
1005C-	QUO	INDELUZ	101

REF.	FAM.	BRAND	PAG.
1006A-	VIPI	INDELUZ	67
1007A-	VIP2	INDELUZ	75
1007B-	VIP2	INDELUZ	77
1008A-	VIP3	INDELUZ	83
1008B-	VIP3	INDELUZ	85
1009A-	VIPI T	INDELUZ	71
1010A-	VIP2 T	INDELUZ	81
1011A-	VIP3 T	INDELUZ	87
1013A-L3826B-01	FISH	EXO	352
1013A-L3826B-02	FISH	EXO	352
1013A-L3826B-50	FISH	EXO	352
1013A-L4026B-01	FISH	EXO	352
1013A-L4026B-02	FISH	EXO	352
1013A-L4026B-50	FISH	EXO	352
1013B-L3826A-01	FISH	EXO	350
1013B-L3826A-02	FISH	EXO	350
1013B-L3826A-50	FISH	EXO	350
1013B-L3826A-IR	FISH	EXO	464
1013B-L4026A-01	FISH	EXO	350
1013B-L4026A-02	FISH	EXO	350
1013B-L4026A-50	FISH	EXO	350
1015A-G05X1A-01	LUG	DOPO	494
1015A-G05X1A-04	LUG	DOPO	494
1015B-G05X1A-01	LUG	DOPO	596
1015B-G05X1A-04	LUG	DOPO	596
1015C-G05X1A-01	LUG	DOPO	596
1015C-G05X1A-04	LUG	DOPO	596
1016A-G05X1A-04	AVON	DOPO	496
1016B-G05X1A-04	AVON	DOPO	600
1017A-G05X1A-01-D1	NEMO	EXO	314
1017A-G05X1A-01-D2	NEMO	EXO	314
1017A-G05X1A-01-D3	NEMO	EXO	314
1017A-G05X1A-02-D4	NEMO	EXO	314
1017B-G05X1A-01-D1	NEMO	EXO	420
1017B-G05X1A-01-D2	NEMO	EXO	420
1017B-G05X1A-01-D3	NEMO	EXO	420
1017B-G05X1A-02-D4	NEMO	EXO	420
1017C-G05X1A-01-D1	NEMO	EXO	421
1017C-G05X1A-01-D2	NEMO	EXO	421
1017C-G05X1A-01-D3	NEMO	EXO	421
1017C-G05X1A-02-D4	NEMO	EXO	421
1017D-G05X1A-01-D1	NEMO	EXO	420
1017D-G05X1A-01-D2	NEMO	EXO	420
1017D-G05X1A-01-D3	NEMO	EXO	420
1017D-G05X1A-02-D4	NEMO	EXO	420
1018A-L3109AA0-04	TURRET	CRISTHER	820
1018A-L3309AA0-04	TURRET	CRISTHER	820
1018B-L312AA0-04	TURRET	CRISTHER	820
1018B-L3312AA0-04	TURRET	CRISTHER	820
1021A-G21X1A-01	TEN	INDELUZ	272
1021A-G21X1A-02	TEN	INDELUZ	272
1021B-G21X1A-01	TEN	INDELUZ	272
1021B-G21X1A-02	TEN	INDELUZ	272
1023A-L3007B10-30	MALVA	CRISTHER	762
1023A-L3007B20-30	MALVA	CRISTHER	762
1023A-L3007B50-30	MALVA	CRISTHER	762
1023A-L3107B10-30	MALVA	CRISTHER	762

REF.	FAM.	BRAND	PAG.
1023A-L3107B20-30	MALVA	CRISTHER	762
1023A-L3107B50-30	MALVA	CRISTHER	762
1023A-L3307B10-30	MALVA	CRISTHER	762
1023A-L3307B20-30	MALVA	CRISTHER	762
1023A-L3307B50-30	MALVA	CRISTHER	762
1023B-L3018B10-30	MALVA	CRISTHER	766
1023B-L3018B1D-30	MALVA	CRISTHER	766
1023B-L3018B20-30	MALVA	CRISTHER	766
1023B-L3018B2D-30	MALVA	CRISTHER	766
1023B-L3018B30-30	MALVA	CRISTHER	766
1023B-L3018B3D-30	MALVA	CRISTHER	766
1023B-L3018BZ0-30	MALVA	CRISTHER	767
1023B-L3018BZD-30	MALVA	CRISTHER	767
1023B-L3118B10-30	MALVA	CRISTHER	766
1023B-L3118B1D-30	MALVA	CRISTHER	766
1023B-L3118B20-30	MALVA	CRISTHER	766
1023B-L3118B2D-30	MALVA	CRISTHER	766
1023B-L3118B30-30	MALVA	CRISTHER	766
1023B-L3118B3D-30	MALVA	CRISTHER	766
1023B-L3118BZ0-30	MALVA	CRISTHER	767
1023B-L3118BZD-30	MALVA	CRISTHER	767
1023B-L3318B10-30	MALVA	CRISTHER	766
1023B-L3318B1D-30	MALVA	CRISTHER	766
1023B-L3318B20-30	MALVA	CRISTHER	766
1023B-L3318B2D-30	MALVA	CRISTHER	766
1023B-L3318B30-30	MALVA	CRISTHER	766
1023B-L3318B3D-30	MALVA	CRISTHER	766
1023B-L3318BZ0-30	MALVA	CRISTHER	767
1023B-L3318BZD-30	MALVA	CRISTHER	767
1023D-L3025B10-30	MALVA	CRISTHER	768
1023D-L3025B1D-30	MALVA	CRISTHER	768
1023D-L3025B30-30	MALVA	CRISTHER	768
1023D-L3025B3D-30	MALVA	CRISTHER	768
1023D-L3025B40-30	MALVA	CRISTHER	768
1023D-L3025B4D-30	MALVA	CRISTHER	768
1023D-L3125B10-30	MALVA	CRISTHER	768
1023D-L3125B1D-30	MALVA	CRISTHER	768
1023D-L3125B30-30	MALVA	CRISTHER	768
1023D-L3125B3D-30	MALVA	CRISTHER	768
1023D-L3125B40-30	MALVA	CRISTHER	768
1023D-L3125B4D-30	MALVA	CRISTHER	768
1023D-L3325B10-30	MALVA	CRISTHER	768
1023D-L3325B1D-30	MALVA	CRISTHER	768
1023D-L3325B30-30	MALVA	CRISTHER	768
1023D-L3325B3D-30	MALVA	CRISTHER	768
1023D-L3325B40-30	MALVA	CRISTHER	768
1023D-L3325B4D-30	MALVA	CRISTHER	768
1023E-L3025B30-30	MALVA	CRISTHER	769
1023E-L3025B3D-30	MALVA	CRISTHER	769
1023E-L3125B30-30	MALVA	CRISTHER	769
1023E-L3125B3D-30	MALVA	CRISTHER	769
1023F-L1412F3X-30	MALVA	CRISTHER	763
1023F-L1412F3X-30	MALVA	CRISTHER	763
1023F-L1412F6X-30	MALVA	CRISTHER	763
1023F-L1412F6X-30	MALVA	CRISTHER	763
1023G-L3016B10-30	MALVA	CRISTHER	764

REF.	FAM.	BRAND	PAG.
1030A-G05XIA-01-RA	MOLN	EXO	384
1030B-G05XIA-01-RA	MOLN	EXO	384
1031A-L3106B-01	SERENE	EXO	332
1031A-L3106B-02	SERENE	EXO	332
1031B-L3106B-01	SERENE	EXO	332
1031B-L3106B-02	SERENE	EXO	332
1031C-L3106B-01	SERENE	EXO	332
1031C-L3106B-02	SERENE	EXO	332
1032A-L3807V20-01	CRETEI	INDELUZ	186
1032A-L3807V20-02	CRETEI	INDELUZ	186
1032A-L3807V2D-01	CRETEI	INDELUZ	186
1032A-L3807V2D-02	CRETEI	INDELUZ	186
1032A-L3807V30-01	CRETEI	INDELUZ	186
1032A-L3807V30-02	CRETEI	INDELUZ	186
1032A-L3807V3D-01	CRETEI	INDELUZ	186
1032A-L3807V3D-02	CRETEI	INDELUZ	186
1032A-L3907V20-01	CRETEI	INDELUZ	186
1032A-L3907V20-02	CRETEI	INDELUZ	186
1032A-L3907V2D-01	CRETEI	INDELUZ	186
1032A-L3907V2D-02	CRETEI	INDELUZ	186
1032A-L3907V30-01	CRETEI	INDELUZ	186
1032A-L3907V30-02	CRETEI	INDELUZ	186
1032A-L3907V3D-01	CRETEI	INDELUZ	186
1032A-L3907V3D-02	CRETEI	INDELUZ	186
1032A-L4007V20-01	CRETEI	INDELUZ	186
1032A-L4007V20-02	CRETEI	INDELUZ	186
1032A-L4007V2D-01	CRETEI	INDELUZ	186
1032A-L4007V2D-02	CRETEI	INDELUZ	186
1032A-L4007V30-01	CRETEI	INDELUZ	186
1032A-L4007V30-02	CRETEI	INDELUZ	186
1032A-L4007V3D-01	CRETEI	INDELUZ	186
1032A-L4007V3D-02	CRETEI	INDELUZ	186
1032B-L3811V10-01	CRETEI	INDELUZ	187
1032B-L3811V10-02	CRETEI	INDELUZ	187
1032B-L3811V1D-01	CRETEI	INDELUZ	187
1032B-L3811V1D-02	CRETEI	INDELUZ	187
1032B-L3811V20-01	CRETEI	INDELUZ	187
1032B-L3811V20-02	CRETEI	INDELUZ	187
1032B-L3811V2D-01	CRETEI	INDELUZ	187
1032B-L3811V2D-02	CRETEI	INDELUZ	187
1032B-L3811V30-01	CRETEI	INDELUZ	187
1032B-L3811V30-02	CRETEI	INDELUZ	187
1032B-L3811V3D-01	CRETEI	INDELUZ	187
1032B-L3811V3D-02	CRETEI	INDELUZ	187
1032B-L3911V10-01	CRETEI	INDELUZ	187
1032B-L3911V10-02	CRETEI	INDELUZ	187
1032B-L3911V1D-01	CRETEI	INDELUZ	187
1032B-L3911V1D-02	CRETEI	INDELUZ	187
1032B-L3911V20-01	CRETEI	INDELUZ	187
1032B-L3911V20-02	CRETEI	INDELUZ	187
1032B-L3911V2D-01	CRETEI	INDELUZ	187
1032B-L3911V2D-02	CRETEI	INDELUZ	187
1032B-L3911V30-01	CRETEI	INDELUZ	187
1032B-L3911V30-02	CRETEI	INDELUZ	187
1032B-L3911V3D-01	CRETEI	INDELUZ	187
1032B-L3911V3D-02	CRETEI	INDELUZ	187
1032B-L4011V10-01	CRETEI	INDELUZ	187

REF.	FAM.	BRAND	PAG.
1032B-L4011V10-02	CRETEI	INDELUZ	187
1032B-L4011VID-01	CRETEI	INDELUZ	187
1032B-L4011VID-02	CRETEI	INDELUZ	187
1032B-L4011V20-01	CRETEI	INDELUZ	187
1032B-L4011V20-02	CRETEI	INDELUZ	187
1032B-L4011V2D-01	CRETEI	INDELUZ	187
1032B-L4011V2D-02	CRETEI	INDELUZ	187
1032B-L4011V30-01	CRETEI	INDELUZ	187
1032B-L4011V30-02	CRETEI	INDELUZ	187
1032B-L4011V3D-01	CRETEI	INDELUZ	187
1032B-L4011V3D-02	CRETEI	INDELUZ	187
1032C-L3818V20-01	CRETEI	INDELUZ	188
1032C-L3818V20-02	CRETEI	INDELUZ	188
1032C-L3818V2D-01	CRETEI	INDELUZ	188
1032C-L3818V2D-02	CRETEI	INDELUZ	188
1032C-L3818V30-01	CRETEI	INDELUZ	188
1032C-L3818V30-02	CRETEI	INDELUZ	188
1032C-L3818V3D-01	CRETEI	INDELUZ	188
1032C-L3818V3D-02	CRETEI	INDELUZ	188
1032C-L3918V20-01	CRETEI	INDELUZ	188
1032C-L3918V20-02	CRETEI	INDELUZ	188
1032C-L3918V2D-01	CRETEI	INDELUZ	188
1032C-L3918V2D-02	CRETEI	INDELUZ	188
1032C-L3918V30-01	CRETEI	INDELUZ	188
1032C-L3918V30-02	CRETEI	INDELUZ	188
1032C-L3918V3D-01	CRETEI	INDELUZ	188
1032C-L3918V3D-02	CRETEI	INDELUZ	188
1032C-L4018V20-01	CRETEI	INDELUZ	188
1032C-L4018V20-02	CRETEI	INDELUZ	188
1032C-L4018V2D-01	CRETEI	INDELUZ	188
1032C-L4018V2D-02	CRETEI	INDELUZ	188
1032C-L4018V30-01	CRETEI	INDELUZ	188
1032C-L4018V30-02	CRETEI	INDELUZ	188
1032C-L4018V3D-01	CRETEI	INDELUZ	188
1032C-L4018V3D-02	CRETEI	INDELUZ	188
1032D-L3813VV0-01	CRETEI	INDELUZ	189
1032D-L3813VV0-02	CRETEI	INDELUZ	189
1032D-L3813VVD-01	CRETEI	INDELUZ	189
1032D-L3813VVD-02	CRETEI	INDELUZ	189
1032D-L3913VV0-01	CRETEI	INDELUZ	189
1032D-L3913VV0-02	CRETEI	INDELUZ	189
1032D-L3913VVD-01	CRETEI	INDELUZ	189
1032D-L3913VVD-02	CRETEI	INDELUZ	189
1032D-L4013VV0-01	CRETEI	INDELUZ	189
1032D-L4013VV0-02	CRETEI	INDELUZ	189
1032D-L4013VVD-01	CRETEI	INDELUZ	189
1032D-L4013VVD-02	CRETEI	INDELUZ	189
1033B-G05XIA-01-CA	CERAMIC	EXO	416
1033B-G05XIA-02-CK	CERAMIC	EXO	416
1033B-G05XIA-47-SG	CERAMIC	EXO	416
1033C-G05XIA-01-CA	CERAMIC	EXO	416
1033C-G05XIA-02-CK	CERAMIC	EXO	416
1033C-G05XIA-47-SG	CERAMIC	EXO	416
1034A-L4106B-01	MURA	DOPO	486
1034A-L4106B-02	MURA	DOPO	486
1034B-L4110B-01	MURA	DOPO	486
1034B-L4110B-02	MURA	DOPO	486

REF.	FAM.	BRAND	PAG.
1035A-L3150AA0-02	FANAL	CRISTHER	836
1035A-L3350AA0-02	FANAL	CRISTHER	836
1036A-L4107BA0-01	KRAO	INDELUZ	242
1036B-L4105B30-01	KRAO	INDELUZ	242
1036C-L4109BAC-01	KRAO	INDELUZ	243
1036D-L4109B3C-01	KRAO	INDELUZ	243
1036E-L4108BAZ-01	KRAO	INDELUZ	243
1037A-G05X1A-02-M1	VIETNAM	EXO	382
1037A-G05X1A-02-M2	VIETNAM	EXO	382
1037B-G05X1A-02-M1	VIETNAM	EXO	382
1037B-G05X1A-02-M2	VIETNAM	EXO	382
1037C-G05X1A-02-M1	VIETNAM	EXO	470
1037C-G05X1A-02-M2	VIETNAM	EXO	470
1038A-L3808V10-01	CRETE2	INDELUZ	190
1038A-L3808V10-02	CRETE2	INDELUZ	190
1038A-L3808VID-01	CRETE2	INDELUZ	190
1038A-L3808VID-02	CRETE2	INDELUZ	190
1038A-L3808V30-01	CRETE2	INDELUZ	190
1038A-L3808V30-02	CRETE2	INDELUZ	190
1038A-L3808V3D-01	CRETE2	INDELUZ	190
1038A-L3808V3D-02	CRETE2	INDELUZ	190
1038A-L3808V50-01	CRETE2	INDELUZ	190
1038A-L3808V50-02	CRETE2	INDELUZ	190
1038A-L3808V5D-01	CRETE2	INDELUZ	190
1038A-L3808V5D-02	CRETE2	INDELUZ	190
1038A-L3908V10-01	CRETE2	INDELUZ	190
1038A-L3908V10-02	CRETE2	INDELUZ	190
1038A-L3908VID-01	CRETE2	INDELUZ	190
1038A-L3908VID-02	CRETE2	INDELUZ	190
1038A-L3908V30-01	CRETE2	INDELUZ	190
1038A-L3908V30-02	CRETE2	INDELUZ	190
1038A-L3908V3D-01	CRETE2	INDELUZ	190
1038A-L3908V3D-02	CRETE2	INDELUZ	190
1038A-L3908V50-01	CRETE2	INDELUZ	190
1038A-L3908V50-02	CRETE2	INDELUZ	190
1038A-L3908V5D-01	CRETE2	INDELUZ	190
1038A-L3908V5D-02	CRETE2	INDELUZ	190
1038A-L4008V10-01	CRETE2	INDELUZ	190
1038A-L4008V10-02	CRETE2	INDELUZ	190
1038A-L4008VID-01	CRETE2	INDELUZ	190
1038A-L4008VID-02	CRETE2	INDELUZ	190
1038A-L4008V30-01	CRETE2	INDELUZ	190
1038A-L4008V30-02	CRETE2	INDELUZ	190
1038A-L4008V3D-01	CRETE2	INDELUZ	190
1038A-L4008V3D-02	CRETE2	INDELUZ	190
1038A-L4008V50-01	CRETE2	INDELUZ	190
1038A-L4008V50-02	CRETE2	INDELUZ	190
1038A-L4008V5D-01	CRETE2	INDELUZ	190
1038A-L4008V5D-02	CRETE2	INDELUZ	190
1038B-L3815V10-01	CRETE2	INDELUZ	191
1038B-L3815V10-02	CRETE2	INDELUZ	191
1038B-L3815VID-01	CRETE2	INDELUZ	191
1038B-L3815VID-02	CRETE2	INDELUZ	191
1038B-L3815V30-01	CRETE2	INDELUZ	191
1038B-L3815V30-02	CRETE2	INDELUZ	191
1038B-L3815V3D-01	CRETE2	INDELUZ	191
1038B-L3815V3D-02	CRETE2	INDELUZ	191

REF.	FAM.	BRAND	PAG.
1038B-L3815V50-01	CRETE2	INDELUZ	191
1038B-L3815V50-02	CRETE2	INDELUZ	191
1038B-L3815V5D-01	CRETE2	INDELUZ	191
1038B-L3815V5D-02	CRETE2	INDELUZ	191
1038B-L3915V10-01	CRETE2	INDELUZ	191
1038B-L3915V10-02	CRETE2	INDELUZ	191
1038B-L3915VID-01	CRETE2	INDELUZ	191
1038B-L3915VID-02	CRETE2	INDELUZ	191
1038B-L3915V30-01	CRETE2	INDELUZ	191
1038B-L3915V30-02	CRETE2	INDELUZ	191
1038B-L3915V3D-01	CRETE2	INDELUZ	191
1038B-L3915V3D-02	CRETE2	INDELUZ	191
1038B-L3915V50-01	CRETE2	INDELUZ	191
1038B-L3915V50-02	CRETE2	INDELUZ	191
1038B-L3915V5D-01	CRETE2	INDELUZ	191
1038B-L3915V5D-02	CRETE2	INDELUZ	191
1038B-L4015V10-01	CRETE2	INDELUZ	191
1038B-L4015V10-02	CRETE2	INDELUZ	191
1038B-L4015VID-01	CRETE2	INDELUZ	191
1038B-L4015VID-02	CRETE2	INDELUZ	191
1038B-L4015V30-01	CRETE2	INDELUZ	191
1038B-L4015V30-02	CRETE2	INDELUZ	191
1038B-L4015V3D-01	CRETE2	INDELUZ	191
1038B-L4015V3D-02	CRETE2	INDELUZ	191
1038B-L4015V50-01	CRETE2	INDELUZ	191
1038B-L4015V50-02	CRETE2	INDELUZ	191
1038B-L4015V5D-01	CRETE2	INDELUZ	191
1038B-L4015V5D-02	CRETE2	INDELUZ	191
1038C-L3806VB0-01	CRETE2	INDELUZ	192
1038C-L3806VB0-02	CRETE2	INDELUZ	192
1038C-L3806VBD-01	CRETE2	INDELUZ	192
1038C-L3806VBD-02	CRETE2	INDELUZ	192
1038C-L3906VB0-01	CRETE2	INDELUZ	192
1038C-L3906VB0-02	CRETE2	INDELUZ	192
1038C-L3906VBD-01	CRETE2	INDELUZ	192
1038C-L3906VBD-02	CRETE2	INDELUZ	192
1038C-L4006VB0-01	CRETE2	INDELUZ	192
1038C-L4006VB0-02	CRETE2	INDELUZ	192
1038C-L4006VBD-01	CRETE2	INDELUZ	192
1038C-L4006VBD-02	CRETE2	INDELUZ	192
1038D-L3813VB0-01	CRETE2	INDELUZ	192
1038D-L3813VB0-02	CRETE2	INDELUZ	192
1038D-L3813VBD-01	CRETE2	INDELUZ	192
1038D-L3813VBD-02	CRETE2	INDELUZ	192
1038D-L3913VB0-01	CRETE2	INDELUZ	192
1038D-L3913VB0-02	CRETE2	INDELUZ	192
1038D-L3913VBD-01	CRETE2	INDELUZ	192
1038D-L3913VBD-02	CRETE2	INDELUZ	192
1038D-L4013VB0-01	CRETE2	INDELUZ	192
1038D-L4013VB0-02	CRETE2	INDELUZ	192
1038D-L4013VBD-01	CRETE2	INDELUZ	192
1038D-L4013VBD-02	CRETE2	INDELUZ	192
1038E-L3825VB0-01	CRETE2	INDELUZ	192
1038E-L3825VB0-02	CRETE2	INDELUZ	192
1038E-L3825VBD-01	CRETE2	INDELUZ	192
1038E-L3825VBD-02	CRETE2	INDELUZ	192
1038E-L3925VB0-01	CRETE2	INDELUZ	192

REF.	FAM.	BRAND	PAG.
1038E-L3925VB0-02	CRETE2	INDELUZ	192
1038E-L3925VBD-01	CRETE2	INDELUZ	192
1038E-L3925VBD-02	CRETE2	INDELUZ	192
1038E-L4025VB0-01	CRETE2	INDELUZ	192
1038E-L4025VB0-02	CRETE2	INDELUZ	192
1038E-L4025VBD-01	CRETE2	INDELUZ	192
1038E-L4025VBD-02	CRETE2	INDELUZ	192
1040A-L3109H30-01	ATIC	CRISTHER	750
1040A-L3309H30-01	ATIC	CRISTHER	750
1040B-L3118I50-01	ATIC	CRISTHER	750
1040B-L3118I50-02	ATIC	CRISTHER	750
1040C-L3124J70-01	ATIC	CRISTHER	751
1040C-L3324J70-01	ATIC	CRISTHER	751
1040D-L3137M90-01	ATIC	CRISTHER	751
1040D-L3337M90-01	ATIC	CRISTHER	751
1041A-L4103K-02	VERSA	DOPO	628
1042A-L4106K-02	TONA	DOPO	632
1042B-L4106K-02	TONA	DOPO	632
1043A-L4103K-02	LUMBER	DOPO	630
1044A-L4105K-02	ERGO	DOPO	626
1044B-L4105K-02	ERGO	DOPO	626
1044C-L4105K-02	ERGO	DOPO	626
1045A-G05X1A-02	FLAKE	EXO	367
1046A-L3336B-01	OFFICE	INDELUZ	270
1046A-L3336B-02	OFFICE	INDELUZ	270
1046B-L3336B-01	OFFICE	INDELUZ	270
1046B-L3336B-02	OFFICE	INDELUZ	270
1047A-L3130B-02	KERO	DOPO	564
1047A-L3330B-02	KERO	DOPO	564
1047A-L3730B-02	KERO	DOPO	564
1047B-L3150B-02	KERO	DOPO	564
1047B-L3350B-02	KERO	DOPO	564
1047B-L3750B-02	KERO	DOPO	564
1047C-L31A1B-02	KERO	DOPO	564
1047C-L33A1B-02	KERO	DOPO	564
1047C-L37A1B-02	KERO	DOPO	564
1047D-L31A4B-02	KERO	DOPO	564
1047D-L33A4B-02	KERO	DOPO	564
1047D-L37A4B-02	KERO	DOPO	564
1047E-L31A5B-02	KERO	DOPO	564
1047E-L33A5B-02	KERO	DOPO	564
1048A-L33RAB-04	LAUTAN	INDELUZ	264
1048A-L37RAB-04	LAUTAN	INDELUZ	264
1048B-L37RAB-04	LAUTAN	INDELUZ	264
1048C-L33RAB-04	LAUTAN	INDELUZ	264
1048C-L37RAB-04	LAUTAN	INDELUZ	264
1049A-L3120B-01	FLOC	DOPO	520
1049A-L3120B-02	FLOC	DOPO	520
1049B-L3130B-01	FLOC	DOPO	520
1049B-L3130B-02	FLOC	DOPO	520
1050A-L3113B-04	EVEN	DOPO	488
1051A-L2925AB0-02	PALAU	CRISTHER	808
1051A-L2925ABD-02	PALAU	CRISTHER	808
1051A-L2925ABG-02	PALAU	CRISTHER	808
1051A-L3025AB0-02	PALAU	CRISTHER	808
1051A-L3025ABD-02	PALAU	CRISTHER	808
1051A-L3025ABG-02	PALAU	CRISTHER	808

REF.	FAM.	BRAND	PAG.
1051A-L3125AB0-02	PALAU	CRISTHER	808
1051A-L3125ABD-02	PALAU	CRISTHER	808
1051A-L3125ABG-02	PALAU	CRISTHER	808
1051A-L325AB0-02	PALAU	CRISTHER	808
1051A-L325ABD-02	PALAU	CRISTHER	808
1051A-L325ABG-02	PALAU	CRISTHER	808
1051B-L2925AB0-02	PALAU	CRISTHER	808
1051B-L2925ABD-02	PALAU	CRISTHER	808
1051B-L2925ABG-02	PALAU	CRISTHER	808
1051B-L3025AB0-02	PALAU	CRISTHER	808
1051B-L3025ABD-02	PALAU	CRISTHER	808
1051B-L3025ABG-02	PALAU	CRISTHER	808
1051B-L3125AB0-02	PALAU	CRISTHER	808
1051B-L3125ABD-02	PALAU	CRISTHER	808
1051B-L3125ABG-02	PALAU	CRISTHER	808
1051B-L325AB0-02	PALAU	CRISTHER	808
1051B-L325ABD-02	PALAU	CRISTHER	808
1051B-L325ABG-02	PALAU	CRISTHER	808
1051B-L3325ABD-02	PALAU	CRISTHER	808
1051B-L3325ABG-02	PALAU	CRISTHER	808
1052A-L3806BV0-04	KALOS	CRISTHER	792
1052A-L3906BV0-04	KALOS	CRISTHER	792
1052A-L4006BV0-04	KALOS	CRISTHER	792
1052B-L3812BV0-04	KALOS	CRISTHER	792
1052B-L3912BV0-04	KALOS	CRISTHER	792
1052B-L4012BV0-04	KALOS	CRISTHER	792
1052C-L3828BV0-04	KALOS	CRISTHER	792
1052C-L3928BV0-04	KALOS	CRISTHER	792
1052C-L4028BV0-04	KALOS	CRISTHER	792
1053A-L4102B90-01	COVER	INDELUZ	266
1054A-L3110B-04	ORBITA	DOPO	484
1054B-L3110B-04	ORBITA	DOPO	590
1055x-	UKU	INDELUZ	161-167
1056x-	UKU	INDELUZ	161-167
1057x-	UKU	INDELUZ	161-167
1058x-	UKU	INDELUZ	161-167
1059x-	UKU	INDELUZ	161-167
1060x-	UKU	INDELUZ	161-167
1061x-	FENIX	INDELUZ	147
1062x-	FENIX	INDELUZ	141
1063x-	FENIX	INDELUZ	145
1064x-	FENIX	INDELUZ	149
1065x-	FENIX	INDELUZ	143
1066x-	FENIX	INDELUZ	139
1069A-L3011FC0-04	DUOMO	CRISTHER	708
1069A-L3111FC0-04	DUOMO	CRISTHER	708
1069A-L3112AC0-04	DUOMO	CRISTHER	708
1069A-L3311FC0-04	DUOMO	CRISTHER	708
1069B-L3011FC0-04	DUOMO	CRISTHER	810
1069B-L3111FC0-04	DUOMO	CRISTHER	810
1069B-L3311FC0-04	DUOMO	CRISTHER	810
1069C-L3011FC0-04	DUOMO	CRISTHER	810
1069C-L3111FC0-04	DUOMO	CRISTHER	810
1069D-L3011FC0-04	DUOMO	CRISTHER	810
1069D-L3111FC0-04	DUOMO	CRISTHER	810
1069D-L3311FC0-04	DUOMO	CRISTHER	810
1069D-L3311FC0-04	DUOMO	CRISTHER	810
1070A-L3002FX0-04	GARDA	CRISTHER	772
1070A-L3102FX0-04	GARDA	CRISTHER	772

REF.	FAM.	BRAND	PAG.
1070A-L3302FX0-04	GARDA	CRISTHER	772
1070B-L3002FX0-04	GARDA	CRISTHER	772
1070B-L3102FX0-04	GARDA	CRISTHER	772
1070B-L3302FX0-04	GARDA	CRISTHER	772
1070C-L3002FX0-04	GARDA	CRISTHER	772
1070C-L3102FX0-04	GARDA	CRISTHER	772
1070C-L3302FX0-04	GARDA	CRISTHER	772
1070D-L3006FX0-04	GARDA	CRISTHER	773
1070D-L3106FX0-04	GARDA	CRISTHER	773
1070D-L3306FX0-04	GARDA	CRISTHER	773
1070E-L3006FX0-04	GARDA	CRISTHER	773
1070E-L3106FX0-04	GARDA	CRISTHER	773
1070E-L3306FX0-04	GARDA	CRISTHER	773
1070F-L3006FX0-04	GARDA	CRISTHER	773
1070F-L3106FX0-04	GARDA	CRISTHER	773
1070F-L3306FX0-04	GARDA	CRISTHER	773
1071A-L4110BBF-01	CROMA	DOPO	491
1071A-L4110BBF-02	CROMA	DOPO	491
1071B-L4115BBF-01	CROMA	DOPO	491
1071B-L4115BBF-02	CROMA	DOPO	491
1072A-L4108BBF-02	IKONA	DOPO	490
1072B-L4108BBF-02	IKONA	DOPO	592
1072C-L4108BBF-02	IKONA	DOPO	592
1073A-L3110A-50	TEC	EXO	410
1073B-L3110A-50	TEC	EXO	294
1073C-L3110A-50	TEC	EXO	348
1074A-VX35B-01-01	MISTRAL	EXO	458
1074A-VX35B-01-57	MISTRAL	EXO	458
1074A-VX35B-01-59	MISTRAL	EXO	458
1074A-VX35B-02-02	MISTRAL	EXO	458
1074A-VX35B-02-57	MISTRAL	EXO	458
1074A-VX35B-02-59	MISTRAL	EXO	458
1074B-W4135B-01-01	MISTRAL	EXO	456
1074B-W4135B-01-57	MISTRAL	EXO	456
1074B-W4135B-01-59	MISTRAL	EXO	456
1074B-W4135B-02-02	MISTRAL	EXO	456
1074B-W4135B-02-57	MISTRAL	EXO	456
1074B-W4135B-02-59	MISTRAL	EXO	456
1075A-H20X1A-01	GEOMETRICAL	EXO	412
1075A-H20X1A-50	GEOMETRICAL	EXO	412
1076A-L3105B-01	SIGN	EXO	292
1076A-L3105B-02	SIGN	EXO	292
1076A-L3105B-46	SIGN	EXO	292
1076B-L3105B-01	SIGN	EXO	292
1076B-L3105B-02	SIGN	EXO	292
1076B-L3105B-46	SIGN	EXO	292
1077A-L3132B-01-02	VINYL	EXO	394
1077A-L3132B-01-47	VINYL	EXO	394
1077A-L3132B-01-50	VINYL	EXO	394
1077A-L3132B-01-71	VINYL	EXO	394
1077B-L3144B-01-02	VINYL	EXO	394
1077B-L3144B-01-47	VINYL	EXO	394
1077B-L3144B-01-50	VINYL	EXO	394
1077B-L3144B-01-71	VINYL	EXO	394
1078A-L3002FC0-04	TASCA	CRISTHER	728
1078A-L3102FC0-04	TASCA	CRISTHER	728
1078A-L3302FC0-04	TASCA	CRISTHER	728

REF.	FAM.	BRAND	PAG.
1078B-L3004FC0-04	TASCA	CRISTHER	728
1078B-L3104FC0-04	TASCA	CRISTHER	728
1078B-L3304FC0-04	TASCA	CRISTHER	728
1078C-L3006FC0-04	TASCA	CRISTHER	728
1078C-L3106FC0-04	TASCA	CRISTHER	728
1078C-L3306FC0-04	TASCA	CRISTHER	728
1079A-G05X1A-01-27	LANTERN	EXO	290
1079A-G05X1A-01-29	LANTERN	EXO	290
1079A-G05X1A-02-27	LANTERN	EXO	290
1079A-G05X1A-02-29	LANTERN	EXO	290
1079A-G05X1A-37-27	LANTERN	EXO	290
1079A-G05X1A-37-29	LANTERN	EXO	290
1079A-G05X1A-47-27	LANTERN	EXO	290
1079A-G05X1A-47-29	LANTERN	EXO	290
1079A-G05X1A-AG-27	LANTERN	EXO	290
1079A-G05X1A-AG-29	LANTERN	EXO	290
1079B-G05X1A-01-27	LANTERN	EXO	290
1079B-G05X1A-01-29	LANTERN	EXO	290
1079B-G05X1A-02-27	LANTERN	EXO	290
1079B-G05X1A-02-29	LANTERN	EXO	290
1079B-G05X1A-37-27	LANTERN	EXO	290
1079B-G05X1A-37-29	LANTERN	EXO	290
1079B-G05X1A-47-27	LANTERN	EXO	290
1079B-G05X1A-47-29	LANTERN	EXO	290
1079B-G05X1A-AG-27	LANTERN	EXO	290
1079B-G05X1A-AG-29	LANTERN	EXO	290
1080A-L4107B-01	CALYPSO3	INDELUZ	258
1080B-L4113B-01	CALYPSO3	INDELUZ	258
1080C-L4118B-01	CALYPSO3	INDELUZ	258
1080D-L4125B-01	CALYPSO3	INDELUZ	258
1081A-L1406E2T-02	TEVA	DOPO	574
1082A-L3105F10-30	CROSCAT	CRISTHER	756
1082A-L3105F40-30	CROSCAT	CRISTHER	756
1082A-L3305F10-30	CROSCAT	CRISTHER	756
1082A-L3305F40-30	CROSCAT	CRISTHER	756
1083A-L3106A-30	CLOT	DOPO	554
1083B-L3116A-30	CLOT	DOPO	554
1084A-L3008A10-04	BUIT	CRISTHER	724
1084A-L3008A10-90	BUIT	CRISTHER	724
1084A-L3008A20-04	BUIT	CRISTHER	724
1084A-L3008A20-90	BUIT	CRISTHER	724
1084A-L3008A30-04	BUIT	CRISTHER	724
1084A-L3008A30-90	BUIT	CRISTHER	724
1084A-L3108A10-04	BUIT	CRISTHER	724
1084A-L3108A10-90	BUIT	CRISTHER	724
1084A-L3108A20-04	BUIT	CRISTHER	724
1084A-L3108A20-90	BUIT	CRISTHER	724
1084A-L3108A30-04	BUIT	CRISTHER	724
1084A-L3108A30-90	BUIT	CRISTHER	724
1084A-L3308A10-04	BUIT	CRISTHER	724
1084A-L3308A10-90	BUIT	CRISTHER	724
1084A-L3308A20-04	BUIT	CRISTHER	724
1084A-L3308A20-90	BUIT	CRISTHER	724
1084A-L3308A30-04	BUIT	CRISTHER	724
1084A-L3308A30-90	BUIT	CRISTHER	724
1084B-L3102A10-04	BUIT	CRISTHER	724
1084B-L3102A10-90	BUIT	CRISTHER	724

REF.	FAM.	BRAND	PAG.
1084B-L3012A20-04	BUIT	CRISTHER	724
1084B-L3012A20-90	BUIT	CRISTHER	724
1084B-L3012A30-04	BUIT	CRISTHER	724
1084B-L3012A30-90	BUIT	CRISTHER	724
1084B-L3112A10-04	BUIT	CRISTHER	724
1084B-L3112A10-90	BUIT	CRISTHER	724
1084B-L3112A20-04	BUIT	CRISTHER	724
1084B-L3112A20-90	BUIT	CRISTHER	724
1084B-L3112A30-04	BUIT	CRISTHER	724
1084B-L3112A30-90	BUIT	CRISTHER	724
1084B-L3312A10-04	BUIT	CRISTHER	724
1084B-L3312A10-90	BUIT	CRISTHER	724
1084B-L3312A20-04	BUIT	CRISTHER	724
1084B-L3312A20-90	BUIT	CRISTHER	724
1084B-L3312A30-04	BUIT	CRISTHER	724
1084B-L3312A30-90	BUIT	CRISTHER	724
1084C-L3012A10-04	BUIT	CRISTHER	726
1084C-L3012A10-90	BUIT	CRISTHER	726
1084C-L3012A20-04	BUIT	CRISTHER	726
1084C-L3012A20-90	BUIT	CRISTHER	726
1084C-L3012A30-04	BUIT	CRISTHER	726
1084C-L3012A30-90	BUIT	CRISTHER	726
1084C-L3112A10-04	BUIT	CRISTHER	726
1084C-L3112A10-90	BUIT	CRISTHER	726
1084C-L3112A20-04	BUIT	CRISTHER	726
1084C-L3112A20-90	BUIT	CRISTHER	726
1084C-L3112A30-04	BUIT	CRISTHER	726
1084C-L3112A30-90	BUIT	CRISTHER	726
1084C-L3312A10-04	BUIT	CRISTHER	726
1084C-L3312A10-90	BUIT	CRISTHER	726
1084C-L3312A20-04	BUIT	CRISTHER	726
1084C-L3312A20-90	BUIT	CRISTHER	726
1084C-L3312A30-04	BUIT	CRISTHER	726
1084C-L3312A30-90	BUIT	CRISTHER	726
1084D-L3026A10-04	BUIT	CRISTHER	726
1084D-L3026A10-90	BUIT	CRISTHER	726
1084D-L3026A20-04	BUIT	CRISTHER	726
1084D-L3026A20-90	BUIT	CRISTHER	726
1084D-L3026A30-04	BUIT	CRISTHER	726
1084D-L3026A30-90	BUIT	CRISTHER	726
1084D-L3126A10-04	BUIT	CRISTHER	726
1084D-L3126A10-90	BUIT	CRISTHER	726
1084D-L3126A20-04	BUIT	CRISTHER	726
1084D-L3126A20-90	BUIT	CRISTHER	726
1084D-L3126A30-04	BUIT	CRISTHER	726
1084D-L3126A30-90	BUIT	CRISTHER	726
1084D-L3326A10-04	BUIT	CRISTHER	726
1084D-L3326A10-90	BUIT	CRISTHER	726
1084D-L3326A20-04	BUIT	CRISTHER	726
1084D-L3326A20-90	BUIT	CRISTHER	726
1084D-L3326A30-04	BUIT	CRISTHER	726
1084D-L3326A30-90	BUIT	CRISTHER	726
1085A-G21X1A-02	BRANCA	DOPO	570
1085B-G21X1A-02	BRANCA	DOPO	570
1085C-G21X1A-02	BRANCA	DOPO	570
1086A-L3105A90-04	FLAT	DOPO	482
1086B-L3109A90-04	FLAT	DOPO	588

REF.	FAM.	BRAND	PAG.
1086C-L3109A90-04	FLAT	DOPO	588
1087A-L3004AA0-04	TRAU	CRISTHER	742
1087A-L3104AA0-04	TRAU	CRISTHER	742
1087A-L3304AA0-04	TRAU	CRISTHER	742
1087B-L3004AA0-04	TRAU	CRISTHER	742
1087B-L3104AA0-04	TRAU	CRISTHER	742
1087B-L3304AA0-04	TRAU	CRISTHER	742
1088A-L3004F90-30	RUA	CRISTHER	740
1088A-L3104F90-30	RUA	CRISTHER	740
1088A-L3304F90-30	RUA	CRISTHER	740
1088B-L3004F90-30	RUA	CRISTHER	740
1088B-L3104F90-30	RUA	CRISTHER	740
1088B-L3304F90-30	RUA	CRISTHER	740
1088C-L3006F90-30	RUA	CRISTHER	740
1088C-L3106F90-30	RUA	CRISTHER	740
1088C-L3306F90-30	RUA	CRISTHER	740
1088D-L3006F90-30	RUA	CRISTHER	740
1088D-L3106F90-30	RUA	CRISTHER	740
1088D-L3306F90-30	RUA	CRISTHER	740
1089A-L1406FIX-02	FUJI	CRISTHER	790
1089A-L1406F2X-02	FUJI	CRISTHER	790
1089A-L1406F6X-02	FUJI	CRISTHER	790
1089A-L1406FKX-02	FUJI	CRISTHER	790
1090A-L14108BBF-02	DAU	CRISTHER	706
1090B-L14115BBF-02	DAU	CRISTHER	706
1092A-	VIPI MINI	INDELUZ	89
1093A-L4124A60-01	BASIC	DOPO	528
1093A-L4124NPO-01	BASIC	DOPO	528
1093A-L4124ZPO-01	BASIC	DOPO	528
A02A-004-00	POSTES	DOPO	651
A02A-406-00	ROUND	DOPO	669
A02B-004-00	POSTES	DOPO	651
A02C-004-00	POSTES	DOPO	651
A02D-004-00	POSTES	DOPO	667
A02F-004-00	POSTES	DOPO	667
A02G-004-00	POSTES	DOPO	667
A04M-796-02	DUBE	INDELUZ	172
A04P-1002-02	ACCESORIOS	INDELUZ	92
A04P-1003-02	ACCESORIOS	INDELUZ	171
A04P-1004-02	ACCESORIOS	INDELUZ	94
A04Q-1006-02	VIP	INDELUZ	66
A04Q-1092-02	VIPI MINI	INDELUZ	88
A04R-835.20.01	HIDRA	INDELUZ	126
A04R-835.20.02	HIDRA	INDELUZ	126
A04R-835.20.47	HIDRA	INDELUZ	126
A05A-1000A-02	DISC	CRISTHER	792
A05A-1052A-02	KALOS	CRISTHER	792
A05A-1069-02	DUOMO	CRISTHER	810
A05A-1089A-02	FUJI	CRISTHER	790
A05A-409-02	NAPOLIS-LULU	DOPO	568
A05A-922A-02	DADO	CRISTHER	798
A05A-922C-02	DADO	CRISTHER	799
A06A-004-01	ELITE 6	DOPO	690
A06A-004-02	ELITE 6	DOPO	690
A06A-1089A-38	FUJI	CRISTHER	790
A07A-128-00	GLOBOS	DOPO	665
A07A-406-39	ROUND	DOPO	669

REF.	FAM.	BRAND	PAG.
A08A-C07-01T	POSTES	DOPO	655
A08A-C07-02T	POSTES	DOPO	655
A13-1093A-02	BASIC	DOPO	528
A13A-	INEL	INDELUZ	115
A13A-1036-02	KRAO	INDELUZ	242
A13A-1053A-01	COVER	INDELUZ	266
A13A-631-01	INEL	INDELUZ	254
A13A-929-01	DAIN	CRISTHER	736
A13A-929-02	DAIN	CRISTHER	736
A13A-929-03	DAIN	CRISTHER	736
A13A-929-90	DAIN	CRISTHER	736
A13B-	INEL	INDELUZ	115
A13B-1036-01	KRAO	INDELUZ	242
A13B-1036-02	KRAO	INDELUZ	242
A13B-1053A-01	COVER	INDELUZ	266
A13B-631-01	INEL	INDELUZ	254
A13B-929-01	DAIN	CRISTHER	736
A13B-929-02	DAIN	CRISTHER	736
A13B-929-03	DAIN	CRISTHER	736
A13B-929-47	DAIN	CRISTHER	736
A13B-929-90	DAIN	CRISTHER	736
A13C-1036-02	KRAO	INDELUZ	243
A13C-1053A-01	COVER	INDELUZ	266
A13C-1053A-01	COVER	INDELUZ	266
A14A-409-05	NAPOLÉS-BELGRADO	DOPO	560
A14A-409-06	NAPOLÉS-BELGRADO	DOPO	560
A14A-409-08	NAPOLÉS-BELGRADO	DOPO	560
A14A-546-05	DONISI	DOPO	545
A14A-546-06	DONISI	DOPO	545
A14A-546-07	DONISI	DOPO	545
A14A-738-00	HAITI/ATOLON	INDELUZ	121
A14B-738-00	HAITI/ATOLON	INDELUZ	121
A14C-738-00	HAITI/ATOLON	INDELUZ	121
A20A-715-01	FRED	EXO	392
A20A-715-02	FRED	EXO	392
A20A-715-03	FRED	EXO	392
A20B-583-01	HIMMEL/SPLAT	INDELUZ	260
A20B-715-01	FRED	EXO	392
A20C-715-01	FRED	EXO	392
A22A-128-29	GLOBOS	DOPO	665
A22B-128-29	GLOBOS	DOPO	665
A22C-128-29	GLOBOS	DOPO	665
A22D-128-29	GLOBOS	DOPO	665
A22E-128-01	GLOBOS	DOPO	665
A22F-128-01	GLOBOS	DOPO	665
A22G-128-29	GLOBOS	DOPO	665
A22H-128-29	GLOBOS	DOPO	665
A23A-128-29	GLOBOS	DOPO	664
A23B-128-29	GLOBOS	DOPO	664
A23C-128-01	GLOBOS	DOPO	664
A23D-128-01	GLOBOS	DOPO	664
A23E-128-01	GLOBOS	DOPO	664
A23F-128-01	GLOBOS	DOPO	664
A23G-128-29	GLOBOS	DOPO	664
A23H-128-29	GLOBOS	DOPO	664
A23I-128-29	GLOBOS	DOPO	664
A44A-772-01	HAITI/ATOLON	INDELUZ	121

REF.	FAM.	BRAND	PAG.
A44A-772-02	HAITI/ATOLON	INDELUZ	121
A44A-772-03	HAITI/ATOLON	INDELUZ	121
A45A-738-01	ATOLON	INDELUZ	121
A45A-738-02	ATOLON	INDELUZ	121
A45A-738-03	ATOLON	INDELUZ	121
A45B-738-01	ATOLON	INDELUZ	121
A45B-738-02	ATOLON	INDELUZ	121
A45B-738-03	ATOLON	INDELUZ	121
A45C-738-01	ATOLON	INDELUZ	121
A45C-738-02	ATOLON	INDELUZ	121
A45C-738-03	ATOLON	INDELUZ	121
A45D-738-01	ATOLON	INDELUZ	121
A45D-738-02	ATOLON	INDELUZ	121
A45D-738-03	ATOLON	INDELUZ	121
A45E-738-01	ATOLON	INDELUZ	121
A45E-738-02	ATOLON	INDELUZ	121
A45E-738-03	ATOLON	INDELUZ	121
A47C-796-92	DUBE	INDELUZ	172
A47D-796-92	DUBE	INDELUZ	172
A47E-796-92	DUBE	INDELUZ	172
A47F-1002-92	ACCESORIOS	INDELUZ	92
A47G-1003-92	ACCESORIOS	INDELUZ	171
A47H-1004-92	ACCESORIOS	INDELUZ	94
A47Q-1006-92	VIP	INDELUZ	66
A47Q-1092-92	VIPI MINI	INDELUZ	88
A47R-1006-92	VIP	INDELUZ	66
A47R-1092-92	VIPI MINI	INDELUZ	88
A47T-1006-92	VIP	INDELUZ	74
A50-778-01-KIT-2M-OP	PERFILES	INDELUZ	224
A50-778-02-KIT-2M-OP	PERFILES	INDELUZ	224
A50-778-39-KIT-2M-OP	PERFILES	INDELUZ	224
A50-DIF-02	PERFILES	INDELUZ	224
A50-DIF-05	PERFILES	INDELUZ	224
A50-DIF-06	PERFILES	INDELUZ	224
A50-DIF-07	PERFILES	INDELUZ	224
A50-DIF-08	PERFILES	INDELUZ	224
A50-DIF-29	PERFILES	INDELUZ	224
A50-DIF-60D	PERFILES	INDELUZ	224
A50D-778-00	PERFILES	INDELUZ	225
A51-778-01-KIT-2M-OP	PERFILES	INDELUZ	224
A51-778-02-KIT-2M-OP	PERFILES	INDELUZ	224
A51-778-39-KIT-2M-OP	PERFILES	INDELUZ	224
A52-778-39-KIT-2M-OP	PERFILES	INDELUZ	225
A52-778-39-KIT-3M-OP	PERFILES	INDELUZ	225
A55A-796-02	DUBE	INDELUZ	172
A55A-796-45	DUBE	INDELUZ	172
A55A-796-46	DUBE	INDELUZ	172
A58C-808-41	FENIX	INDELUZ	149
A58E-1061-41	FENIX	INDELUZ	141
A58F-1065-41	FENIX	INDELUZ	143
A60C-1085-02	BRANCA	DOPO	570
A61A-786-01	TRACK	INDELUZ	279
A61A-786-02	TRACK	INDELUZ	279
A61A-786-03	TRACK	INDELUZ	279
A61B-786-01	TRACK	INDELUZ	279
A61B-786-02	TRACK	INDELUZ	279
A61B-786-03	TRACK	INDELUZ	279

REF.	FAM.	BRAND	PAG.
B02Q-X3396F-00	ALIMENTADORES	INDELUZ	239
B02R-X3335F-00	ALIMENTADORES	INDELUZ	239
B02R-X3360F-00	ALIMENTADORES	INDELUZ	239
B02R-X33A1F-01	ALIMENTADORES	INDELUZ	239
B02R-X33A4F-00	ALIMENTADORES	INDELUZ	239
B02V-X3375V-00	Track 48V	INDELUZ	863
B02V-X33J5F-00	ALIMENTADORES	INDELUZ	239
B02V-X33J5V-00	Track 48V	INDELUZ	863
B02W-X3340F-00	ALIMENTADORES	INDELUZ	239
B02W-X3380F-00	ALIMENTADORES	INDELUZ	239
B02W-X33A4F-00	ALIMENTADORES	INDELUZ	239
B02Y-X3335F-00	ALIMENTADORES	INDELUZ	239
B02Y-X3360F-00	ALIMENTADORES	INDELUZ	239
B02Y-X33A1F-00	ALIMENTADORES	INDELUZ	239
B02Y-X33A4F-00	ALIMENTADORES	INDELUZ	239
B02Y-X33A6F-00	ALIMENTADORES	INDELUZ	239
B03A-X33X2A-02	CONECTORES	NX Lighting	861
B03C-X33X2A-02	CONECTORES	NX Lighting	861
B03D-X33X2A-02	CONECTORES	NX Lighting	861
B03F-X33X1A-29	POSTES	DOPO	667
B03I-X33X2A-02	CONECTORES	NX Lighting	861
B03J-X33X2A-02	CONECTORES	NX Lighting	861
B03K-X33X2A-02	CONECTORES	NX Lighting	861
B03L-X33X2A-02	CONECTORES	NX Lighting	861
B03M-X33X2A-02	CONECTORES	NX Lighting	861
B03N-X33X2A-02	CONECTORES	NX Lighting	861
B05Q-X33X2X-03	CONTROL RGB	CRISTERH	848
B12A-G05X1A-02	GLOBOS	DOPO	665
B12F-G05X1A-02	GLOBOS	DOPO	665
B12G-G05X1A-02	GLOBOS	DOPO	665
B12H-G05X1A-02	GLOBOS	DOPO	665
B12I-G05X1A-02T	GLOBOS	DOPO	665
B12J-G05X1A-01T	GLOBOS	DOPO	664
B12J-G05X1A-02T	GLOBOS	DOPO	664
B12K-G05X1A-01T	GLOBOS	DOPO	664
B12K-G05X1A-02T	GLOBOS	DOPO	664
B12L-G05X1A-01T	GLOBOS	DOPO	664
B12L-G05X1A-02T	GLOBOS	DOPO	664
B12M-G05X1A-02T	GLOBOS	DOPO	665
B17F-X33X2B-01	TRACK	INDELUZ	279
B17F-X33X2B-02	TRACK	INDELUZ	279
B17F-X33X2B-03	TRACK	INDELUZ	279
B17O-X33X2B-01	TRACK	INDELUZ	279
B17O-X33X2B-02	TRACK	INDELUZ	279
B17P-X33X2B-01	ACCESORIOS	EXO	362
B17P-X33X2B-02	ACCESORIOS	EXO	362
B17P-X33X2B-03	ACCESORIOS	EXO	362
B19A-X3310B-01	DUBE	INDELUZ	173
B19A-X3310B-02	DUBE	INDELUZ	173
B19B-X3340B-01	DUBE	INDELUZ	173
B19B-X3340B-02	DUBE	INDELUZ	173
B19C-X3330B-01	DUBE	INDELUZ	173
B19C-X3330B-02	DUBE	INDELUZ	173
B19E-X3310B-01	DUBE	INDELUZ	173
B19E-X3310B-02	DUBE	INDELUZ	173
B19F-X3330B-01	DUBE	INDELUZ	173
B19F-X3330B-02	DUBE	INDELUZ	173

REF.	FAM.	BRAND	PAG.
B19G-X3315A-01	DUBE	INDELUZ	173
B19G-X3315A-02	DUBE	INDELUZ	173
B19G-X33R1B-01	DUBE	INDELUZ	173
B19G-X33R1B-02	DUBE	INDELUZ	173
B19G-X33RDB-01	DUBE	INDELUZ	173
B19G-X33RDB-02	DUBE	INDELUZ	173
B19G-X33RFB-01	DUBE	INDELUZ	173
B19G-X33RFB-02	DUBE	INDELUZ	173
B19G-X33RMB-01	DUBE	INDELUZ	173
B19G-X33RMB-02	DUBE	INDELUZ	173
B19H-X3310B-01	DUBE	INDELUZ	173
B19H-X3310B-02	DUBE	INDELUZ	173
B25-X33X2B-01	ENIGMA/FALL/LAND	INDELUZ	180
B25-X33X2B-02	ENIGMA/FALL/LAND	INDELUZ	180
B28A-X33X2B-01	TRACK	INDELUZ	278
B28A-X33X2B-02	TRACK	INDELUZ	278
B28A-X33X2B-39	TRACK	INDELUZ	278
B28B-X33X2B-01	TRACK	INDELUZ	278
B28B-X33X2B-02	TRACK	INDELUZ	278
B28B-X33X2B-39	TRACK	INDELUZ	278
B28C-X33X2B-01	TRACK	INDELUZ	278
B28C-X33X2B-02	TRACK	INDELUZ	278
B28C-X33X2B-39	TRACK	INDELUZ	278
B28D-X33X2B-01	TRACK	INDELUZ	278
B28D-X33X2B-02	TRACK	INDELUZ	278
B28D-X33X2B-03	TRACK	INDELUZ	278
B28E-X33X2B-01	TRACK	INDELUZ	278
B28E-X33X2B-02	TRACK	INDELUZ	278
B28E-X33X2B-03	TRACK	INDELUZ	278
B28G-X33X2B-01	TRACK	INDELUZ	278
B28G-X33X2B-03	TRACK	INDELUZ	278
B28H-X33X2B-01	TRACK	INDELUZ	278
B28H-X33X2B-02	TRACK	INDELUZ	278
B28H-X33X2B-03	TRACK	INDELUZ	278
B28I-X33X2B-01	TRACK	INDELUZ	278
B28I-X33X2B-02	TRACK	INDELUZ	278
B28I-X33X2B-03	TRACK	INDELUZ	278
B28J-X33X2B-01	TRACK	INDELUZ	278
B28J-X33X2B-02	TRACK	INDELUZ	278
B28J-X33X2B-03	TRACK	INDELUZ	278
B28K-X33X2B-01	TRACK	INDELUZ	278
B28K-X33X2B-02	TRACK	INDELUZ	278
B28K-X33X2B-03	TRACK	INDELUZ	278
B28L-X33X2B-01	TRACK	INDELUZ	278
B28L-X33X2B-02	TRACK	INDELUZ	278
B28L-X33X2B-03	TRACK	INDELUZ	278
B28M-X33X2B-01	TRACK	INDELUZ	278
B28M-X33X2B-02	TRACK	INDELUZ	278
B28M-X33X2B-03	TRACK	INDELUZ	278
B28N-X33X2B-01	TRACK	INDELUZ	278
B28N-X33X2B-02	TRACK	INDELUZ	278
B28N-X33X2B-03	TRACK	INDELUZ	278
B29A-X33X2U-01	TRACK	INDELUZ	280
B29A-X33X2U-02	TRACK	INDELUZ	280
B29A-X33X2U-39	TRACK	INDELUZ	280
B29B-X33X2U-01	TRACK	INDELUZ	280

REF.	FAM.	BRAND	PAG.	REF.	FAM.	BRAND	PAG.
B29B-X33X2U-02	TRACK	INDELUZ	280	B32D-X33X2V-02	TRACK 48V	INDELUZ	195
B29B-X33X2U-39	TRACK	INDELUZ	280	B32E-X33X2V-01	TRACK 48V	INDELUZ	195
B29C-X33X2U-01	TRACK	INDELUZ	280	B32E-X33X2V-02	TRACK 48V	INDELUZ	195
B29C-X33X2U-02	TRACK	INDELUZ	280	B32F-X33X2V-01	TRACK 48V	INDELUZ	195
B29C-X33X2U-39	TRACK	INDELUZ	280	B32F-X33X2V-02	TRACK 48V	INDELUZ	195
B29D-X33X2U-01	TRACK	INDELUZ	280	B32G-X33X2V-01	TRACK 48V	INDELUZ	195
B29D-X33X2U-02	TRACK	INDELUZ	280	B32G-X33X2V-02	TRACK 48V	INDELUZ	195
B29D-X33X2U-03	TRACK	INDELUZ	280	B32H-X33X2V-01	TRACK 48V	INDELUZ	195
B29E-X33X2U-01	TRACK	INDELUZ	280	B32H-X33X2V-02	TRACK 48V	INDELUZ	195
B29E-X33X2U-02	TRACK	INDELUZ	280	B32J-X33X2V-01	TRACK 48V	INDELUZ	195
B29E-X33X2U-03	TRACK	INDELUZ	280	B32J-X33X2V-02	TRACK 48V	INDELUZ	195
B29F-X33X2U-01	TRACK	INDELUZ	280	B32K-X33X2V-01	TRACK 48V	INDELUZ	195
B29F-X33X2U-02	TRACK	INDELUZ	280	B32K-X33X2V-02	TRACK 48V	INDELUZ	195
B29F-X33X2U-03	TRACK	INDELUZ	280	B32L-X33AIV-01	TRACK 48V	INDELUZ	195
B29H-X33X2U-01	TRACK	INDELUZ	280	B32L-X33AIV-02	TRACK 48V	INDELUZ	195
B29H-X33X2U-02	TRACK	INDELUZ	280	B32M-X33AIV-01	TRACK 48V	INDELUZ	195
B29H-X33X2U-03	TRACK	INDELUZ	280	B32M-X33AIV-02	TRACK 48V	INDELUZ	195
B29I-X33X2U-01	TRACK	INDELUZ	281	B32N-X33AIV-01	Track 48V	INDELUZ	863
B29I-X33X2U-02	TRACK	INDELUZ	281	B32N-X33AIV-02	Track 48V	INDELUZ	863
B29I-X33X2U-03	TRACK	INDELUZ	281	B32N-X33A6V-01	Track 48V	INDELUZ	863
B29J-X33X2U-01	TRACK	INDELUZ	280	B32N-X33A6V-02	Track 48V	INDELUZ	863
B29J-X33X2U-02	TRACK	INDELUZ	280	B33A-X33X2V-01	TRACK 48V	INDELUZ	198
B29J-X33X2U-03	TRACK	INDELUZ	280	B33A-X33X2V-02	TRACK 48V	INDELUZ	198
B29K-X33X2U-01	TRACK	INDELUZ	281	B33B-X33X2V-01	TRACK 48V	INDELUZ	198
B29K-X33X2U-02	TRACK	INDELUZ	281	B33B-X33X2V-02	TRACK 48V	INDELUZ	198
B29K-X33X2U-03	TRACK	INDELUZ	281	B33C-X33X2V-01	TRACK 48V	INDELUZ	198
B29L-X33X2U-01	TRACK	INDELUZ	280	B33C-X33X2V-02	TRACK 48V	INDELUZ	198
B29L-X33X2U-02	TRACK	INDELUZ	280	B34A-X33X2V-01	TRACK 48V	INDELUZ	196
B29L-X33X2U-03	TRACK	INDELUZ	280	B34A-X33X2V-02	TRACK 48V	INDELUZ	196
B29M-X33X2U-01	TRACK	INDELUZ	280	B34B-X33X2V-01	TRACK 48V	INDELUZ	196
B29M-X33X2U-02	TRACK	INDELUZ	280	B34B-X33X2V-02	TRACK 48V	INDELUZ	196
B29M-X33X2U-03	TRACK	INDELUZ	280	B34C-X33X2V-01	TRACK 48V	INDELUZ	196
B30A-X33X2B-01	TRACK	INDELUZ	278	B34C-X33X2V-02	TRACK 48V	INDELUZ	196
B30A-X33X2B-02	TRACK	INDELUZ	278	B35A-X33X2V-01	TRACK 48V	INDELUZ	200
B30A-X33X2B-39	TRACK	INDELUZ	278	B35A-X33X2V-02	TRACK 48V	INDELUZ	200
B30B-X33X2B-01	TRACK	INDELUZ	278	B35B-X33X2V-01	TRACK 48V	INDELUZ	200
B30B-X33X2B-02	TRACK	INDELUZ	278	B35B-X33X2V-02	TRACK 48V	INDELUZ	200
B30B-X33X2B-39	TRACK	INDELUZ	278	B35C-X33X2V-01	TRACK 48V	INDELUZ	200
B30C-X33X2B-01	TRACK	INDELUZ	278	B35C-X33X2V-02	TRACK 48V	INDELUZ	200
B30C-X33X2B-02	TRACK	INDELUZ	278	B61A-	FENIX	INDELUZ	141
B30C-X33X2B-39	TRACK	INDELUZ	278	B64A-	FENIX	INDELUZ	149
B31A-X33X2U-01	TRACK	INDELUZ	280	B65A-	FENIX	INDELUZ	143
B31A-X33X2U-02	TRACK	INDELUZ	280	base-NbT	POSTES	DOPO	651
B31A-X33X2U-39	TRACK	INDELUZ	280	base-NnT	POSTES	DOPO	651
B31B-X33X2U-01	TRACK	INDELUZ	280	Base-RbT	POSTES	DOPO	651
B31B-X33X2U-02	TRACK	INDELUZ	280	Base-RnT	POSTES	DOPO	651
B31B-X33X2U-39	TRACK	INDELUZ	280	Base-VbT	POSTES	DOPO	651
B31C-X33X2U-01	TRACK	INDELUZ	280	Base-VnT	POSTES	DOPO	651
B31C-X33X2U-02	TRACK	INDELUZ	280	C02B-32-02	POSTES	DOPO	667
B31C-X33X2U-39	TRACK	INDELUZ	280	C02C-32-02	POSTES	DOPO	667
B32A-X33X2V-01	TRACK 48V	INDELUZ	194	C02D-32-02	POSTES	DOPO	667
B32A-X33X2V-02	TRACK 48V	INDELUZ	194	C02F-32-02	POSTES	DOPO	667
B32B-X33X2V-01	TRACK 48V	INDELUZ	194	C03B-32-39	POSTES	DOPO	667
B32B-X33X2V-02	TRACK 48V	INDELUZ	194	C03C-32-39	POSTES	DOPO	667
B32C-X33X2V-01	TRACK 48V	INDELUZ	194	C03D-32-39	POSTES	DOPO	667
B32C-X33X2V-02	TRACK 48V	INDELUZ	194	C03F-32-39	POSTES	DOPO	667
B32D-X33X2V-01	TRACK 48V	INDELUZ	195	C04A-32-02	POSTES	DOPO	666

REF.	FAM.	BRAND	PAG.
C04B-32-02	POSTES	DOPO	666
C04C-32-02	POSTES	DOPO	666
C04D-32-02	POSTES	DOPO	666
C04E-32-02	POSTES	DOPO	666
C06A-31-02	POSTES	DOPO	666
C06B-31-02	POSTES	DOPO	666
C07A-11-01T	POSTES	DOPO	655
C07A-11-02T	POSTES	DOPO	655
C07B-12-01T	POSTES	DOPO	655
C07B-12-02T	POSTES	DOPO	655
C07C-12-01T	POSTES	DOPO	655
C07C-12-02T	POSTES	DOPO	655
C07D-42-02T	POSTES	DOPO	668
C07E-42-02T	POSTES	DOPO	668
C07F-42-02T	POSTES	DOPO	668
C08B-31-02	POSTES	DOPO	658
C08C-31-02	POSTES	DOPO	658
C10A-31-02	POSTES	DOPO	659
C10B-31-02	POSTES	DOPO	659
C12A-32-02	POSTES	DOPO	679
C12B-32-02	POSTES	DOPO	679
C12C-32-02	POSTES	DOPO	679
C30B-31-38	POSTES	DOPO	667
C30D-31-38	POSTES	DOPO	667
C30E-31-38	POSTES	DOPO	667
C30F-31-38	POSTES	DOPO	667
C30G-32-38	POSTES	DOPO	667
CAB.SET.I3.VOLGA	VOLGA	INDELUZ	222
CAB.SET.I9.VOLGA	VOLGA	INDELUZ	223
CEM-1069-02	DIJOMO	CRISTHER	810
CONAC-B03A-KIT	CONECTORES	INDELUZ	218
CONAC-B03B-KIT	CONECTORES	INDELUZ	218
CONAS-B03A-KIT	CONECTORES	INDELUZ	204
CONAS-B03B-KIT	CONECTORES	INDELUZ	204
CONDS-B03A-KIT	CONECTORES	INDELUZ	205
CONDS-B03B-KIT	CONECTORES	INDELUZ	205
CONT.AMPL_DMx512_5CBL	AMPLIFICADOR DMX	CRISTHER	849
CONT.CBU-PWM4	CONTROLADORES	INDELUZ	234
CONT.DA1	CONTROLADORES	INDELUZ	238
CONT.DA4	CONTROLADORES	INDELUZ	238
CONT.DEC_DMx512_5CBL	DESCODIFICADOR	CRISTHER	849
CONT.DMX512_5CBL	CONTROL DMX	CRISTHER	849
CONT.DT	CONTROLADORES	INDELUZ	238
CONT.EV1-S	CONTROLADORES	INDELUZ	238
CONT.EV4	CONTROLADORES	INDELUZ	238
CONT.LIWT	CONTROLADORES	INDELUZ	237
CONT.R9+XC	CONTROLADORES	INDELUZ	790
CONT.RT10	CONTROLADORES	INDELUZ	230
CONT.T15	CONTROLADORES	INDELUZ	230
CONT.V1	CONTROLADORES	INDELUZ	231
CONT.V2-L	CONTROLADORES	INDELUZ	231
CONT.V4	CONTROLADORES	INDELUZ	232
CONT.V4WP	CONTROLADORES	INDELUZ	234
CONT.V5	CONTROLADORES	INDELUZ	233
CONT.WT1	CONTROLADORES	INDELUZ	235

REF.	FAM.	BRAND	PAG.
CONT.WT5	CONTROLADORES	INDELUZ	236
D20-824-01-01	NOK20	INDELUZ	244
D20-824-02-02	NOK20	INDELUZ	244
D20-824-47-47	NOK20	INDELUZ	244
D30-824-01-01	NOK30	INDELUZ	245
D30-824-02-02	NOK30	INDELUZ	245
D30-824-47-47	NOK30	INDELUZ	245
GRA_205CN_8x12	SENA	INDELUZ	220
GRA_207CN	SENA	INDELUZ	220
RES-1089A-38	FUJI	CRISTHER	763
TAP.SET.IP65.SENA205CN	SENA	INDELUZ	220
TAP.SET.IP65.SENA207CN	SENA	INDELUZ	220
TAP.SET.IP65.SENARGB	SENA	INDELUZ	221

