

EN

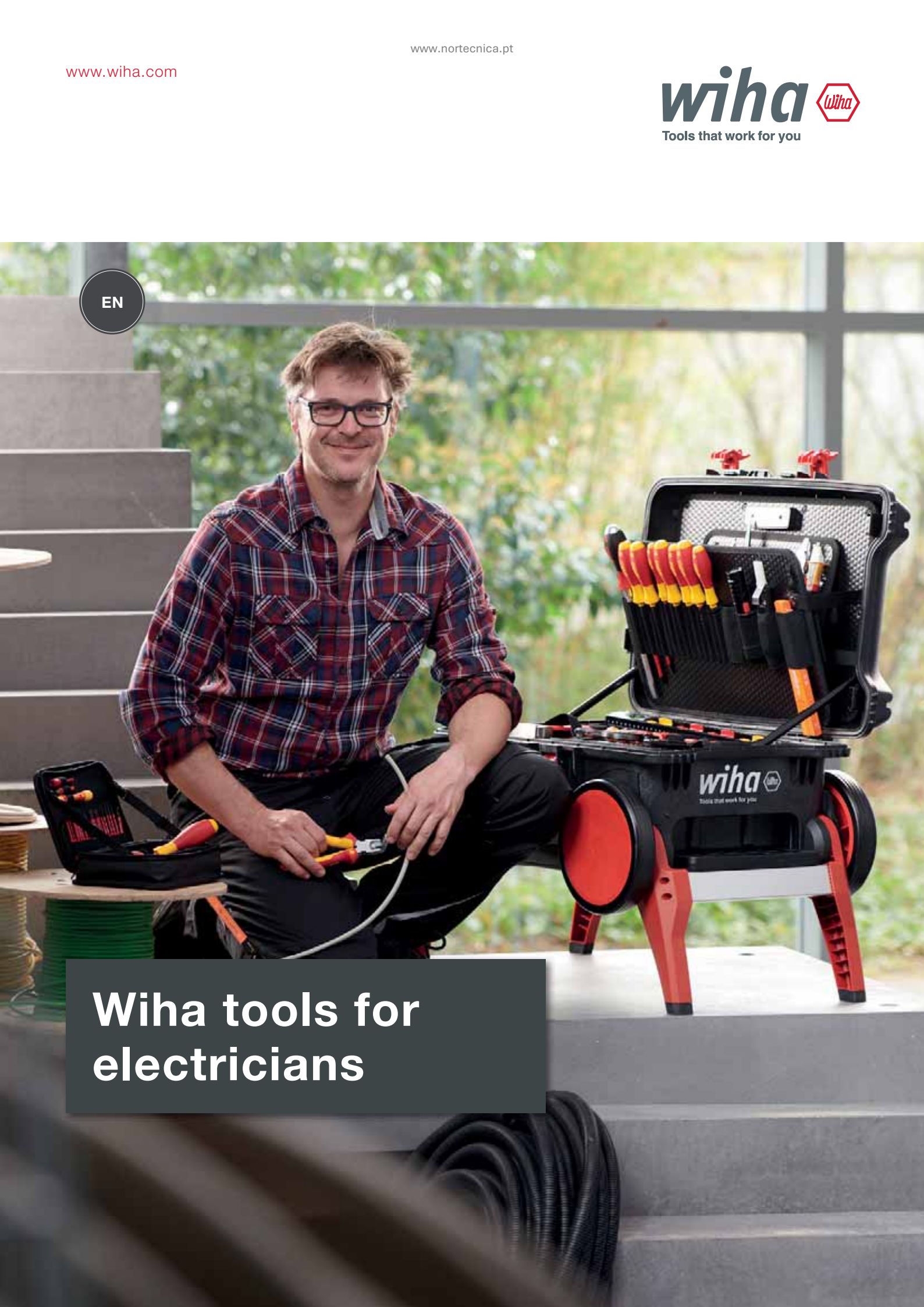

**Wiha tools for  
electricians**



## Wiha – our goal: your success

- **Your guarantee for quality**



- **Reliable and dependable**  
German family-owned company with more than 80 years of experience.
- **Your advantage**  
Customised problem-solving for professionals.
- **Cutting-edge technology**  
Award-winning innovations valued by professionals throughout the world.

What makes your work easier? Tools that increase your efficiency, reduce costs and preserve your health. This is why Wiha develops, designs and manufactures products that meet the highest functionality, durability and ergonomic demands.

Founded over 80 years ago as a small family-owned business for standard parts and screws, Wiha has grown to become a global company with factories all over Europe, Asia and the United States and are still owner-operated by the Hahn family.

Wiha offers the professional a wide range of high-quality premium tools, characterized by their use of the latest manufacturing technologies, application-oriented innovations, ergonomic superiority, top quality, absolute reliability and long service life. In short, tools that make your work noticeably easier - tools that work for you.

Learn more about Wiha on our website: [www.wiha.com](http://www.wiha.com)

# Maximum power transmission, comfortable to use and without loss.

## To work safer, more efficiently and with less strain on the body.

### Certified safety – from our own safety testing procedure according to IEC standards.

**Voltage testing:** All Wiha VDE-tools, which have special markings, are individually tested at 10,000 V AC and are approved for 1,000 V AC and 1,500 V DC.

**Cold shock test:** Cooling down to -25° C. The skinning material must retain its toughness, so that it doesn't break when subjected to shock and knocks.

**Test of electrical skinning properties:** 24 hours storage in water, then 3 minutes test at 10,000 V AC. There must neither be flashover nor disruptive discharge.

**Test of the adhesion of the skinning material coating:** 168 hours storage at 70° C, then test of adhesion at 500 N.

**Pressure tests:** Test at 20 N pressure load, 70° C temperature and 5,000 V AC test voltage. No disruptive discharge may occur.

**Test of combustion behaviour:** The tools are subjected to a flame for 10 seconds. The skinning material must then extinguish and not continue to burn.

### Safety note

The following equipment is required for all work on or around live components and should be appropriate for the specific task

- insulating personal protective equipment
- insulating safety mechanisms
- insulated tools

Before starting work, you must disconnect all active, live components of electrical machines and equipment and ensure that they remain disconnected while you carry out the work.

This is achieved by complying with the five safety rules:

- disconnect
- secure against reconnection
- ensure power is switched off
- earth and short-circuit

cover or block off adjacent live components

Certified by the VDE Testing and Certification Institute and individually tested according to the international standard IEC 60900.



---

As an internationally recognized institute, the VDE is responsible for the testing and certification of electrotechnical products. Wiha provides the professional with a broad range of VDE products, developed and continuously optimized specifically for electricians, which also provide application-oriented solutions for everyday use.

The Wiha quality-management system according to ISO 9001:2015 ensures that only first-class products are manufactured – and that you can work with products of excellent quality. To ensure maximum safety for the user, the entire Wiha VDE range must undergo the most stringent inspections and individual tests. All Wiha VDE-tools hold multiple certifications: The VDE-GSmark stands for safety with regard to any risk, from electrical right up to radiological. Products labelled with a double triangle and a voltage range are suitable for work with live parts.

The international standard IEC 60900 defines the construction, safety as well as single, series, and random testing of insulated tools. But with Wiha you don't just work safer, but also healthier and more efficiently. Specially developed ergonomic geometries ensure comfortable handling that protects the body from strain. The result: easier work, less signs of fatigue, more efficiency.



# SHOWTIME STARS FOR ALL APPLICATIONS



**STARS FOR ELECTRICIANS**





# STARS FOR MECHANICS



**Tool case set XXL III electric**  
Page 14



**Tool set service technician**  
Page 18



**Tool set slimVario® electric**  
Page 19



**Tool set electrician**  
Page 22



**E-screwdriver, speedE® II electric**  
Page 30



**Torque set easyTorque adapter electric**  
Page 42



**Screwdriver with bit magazine PocketMax® electric**  
Page 53



**Screwdriver with bit holder set electric slimVario®**  
Page 57



**Torque screwdriver set TorqueVario®-S electric**  
Page 39



**slimBit electric bit set**  
Page 43



**Screwdriver with bit magazine LiftUp electric**  
Page 52



**Fine screwdriver set PicoFinish® slimVario® electric**  
Page 57



**High-performance diagonal cutters BiCut® Professional with DynamicJoint®**  
Page 110



**Heavy-duty diagonal cutters Professional electric with DynamicJoint®**  
Page 112



**Cable cutter Professional electric**  
Page 112



**Combination pliers Professional electric with DynamicJoint® and OptiGrip**  
Page 113



**Needle nose pliers Professional electric**  
Page 119



**Combination pliers Professional electric with DynamicJoint® and OptiGrip**  
Page 119



**Water pump pliers Professional electric**  
Page 120



**Professional electric water pump pliers**  
Page 120



**Installation pliers TriCut® Professional electric**  
Page 130



**Stripping diagonal cutters Professional electric with DynamicJoint®**  
Page 131



**Stripping tool with self-rotating drag blade**  
Page 132



**Stripping tool automatic**  
Page 134



**Flashlight with LED, laser and UV light**  
Page 154



**Torque QuickCheck torque testing device set**  
Page 155



**Single-pole, non-contact volt detector, 12-1,000 V AC**  
Page 156



**Voltage tester SoftFinish® single-pole, 110-250 volts**  
Page 157



**SoftFinish® dowel racket set with dowels**  
Page 162



**Electrician's hammer**  
Page 162



**Tool set electrician**  
Page 23



**Ratchet wrench set insulated 1/2"**  
Page 24



**Single open-end spanner set, insulated 6-32 mm**  
Page 25



**Range of Applications**  
From page 10

**Torque screwdriver with T-handle TorqueVario®-S T electric**  
Page 48



**Screwdriver SoftFinish® electric slimFix**  
Page 66



**Screwdriver with bit magazine magnetic**  
Page 77



**Screwdriver with bit magazine LiftUp 25 magnetic**  
Page 77



**L-key set in ErgoStar holder**  
Page 94



**BitBuddy® TY bit set, 29 mm**  
Page 81



**Fastening / jamming**  
From page 26

**Precision mechanic's diagonal cutters Classic**  
Page 114



**Craftsman's cutters**  
Page 114



**Hacksaw electric**  
Page 114



**Trimming / cutting**  
From page 106

**Long flat-nose pliers Professional electric**  
Page 120



**Pliers wrench Professional electric**  
Page 121



**Circlip pliers Classic with MagicTips®**  
Page 125



**Supplying / holding**  
From page 116

**Automatic crimp tool**  
Page 136



**Automatic crimp tool**  
Page 136



**Stripping and crimping tool set 4-pcs.**  
Page 138



**Stripping/ insulating / crimping**  
From page 126

**Electrician's Longlife® folding ruler, 2 m**  
Page 157



**Electrician's spirit level**  
Page 157



**Surveying / marking / measuring / checking**  
From page 150

**Striking / chiselling**  
From page 158

Range of Applications

Fastening / jamming

Trimming / cutting

Supplying / holding

Stripping/ insulating / crimping

Surveying / marking / measuring / checking

Striking / chiselling

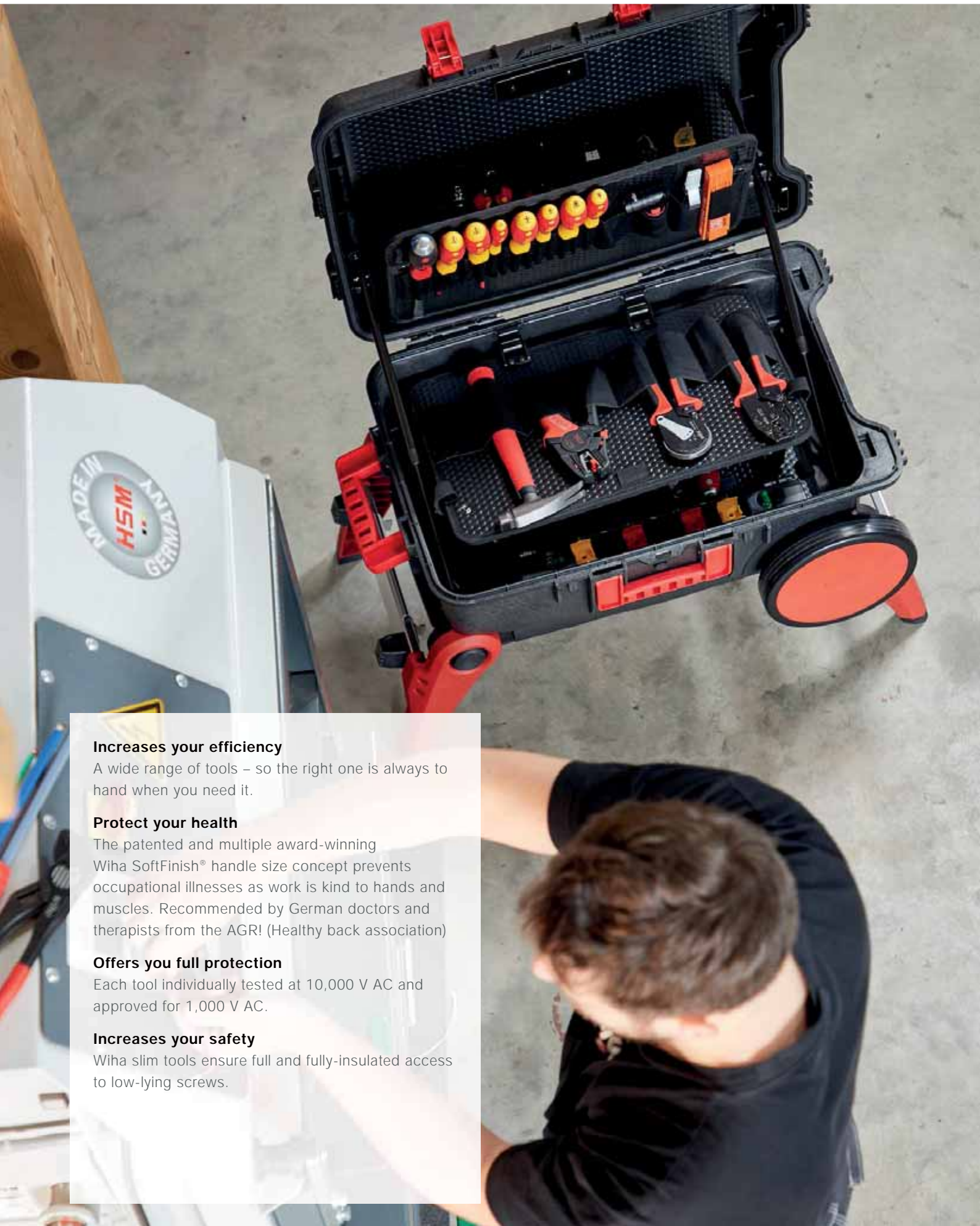

**Increases your efficiency**

A wide range of tools – so the right one is always to hand when you need it.

**Protect your health**

The patented and multiple award-winning Wiha SoftFinish® handle size concept prevents occupational illnesses as work is kind to hands and muscles. Recommended by German doctors and therapists from the AGR! (Healthy back association)

**Offers you full protection**

Each tool individually tested at 10,000 V AC and approved for 1,000 V AC.

**Increases your safety**

Wiha slim tools ensure full and fully-insulated access to low-lying screws.

# The range. Cases that really deliver.

The professional often has reservations about conventional tool boxes: too inaccessible, little storage space, not robust enough. Deficiencies that Wiha has taken to heart – and eliminated – in the development of its case sets. Wiha cases therefore combine many good qualities: Thanks to its extra large wheels it is very easy to conveniently pull the case along on rugged terrain or stairs. The durable PP-plastic with reinforced plastic elements ensures a long lifespan. Gas-filled shock absorbers hold the cover in all positions and reduce the risk of injury when closing. Tool trays ensure quick and easy access to the tool, the case itself provides a lot of extra storage space for small items and machines. And, last but not least, you can easily access the right tool, whenever it is needed.

**"A case with all major Wiha tools and innovations - like Christmas for the electrician!"**

Max Buhl



# Your entire workshop - now you can take it with you!

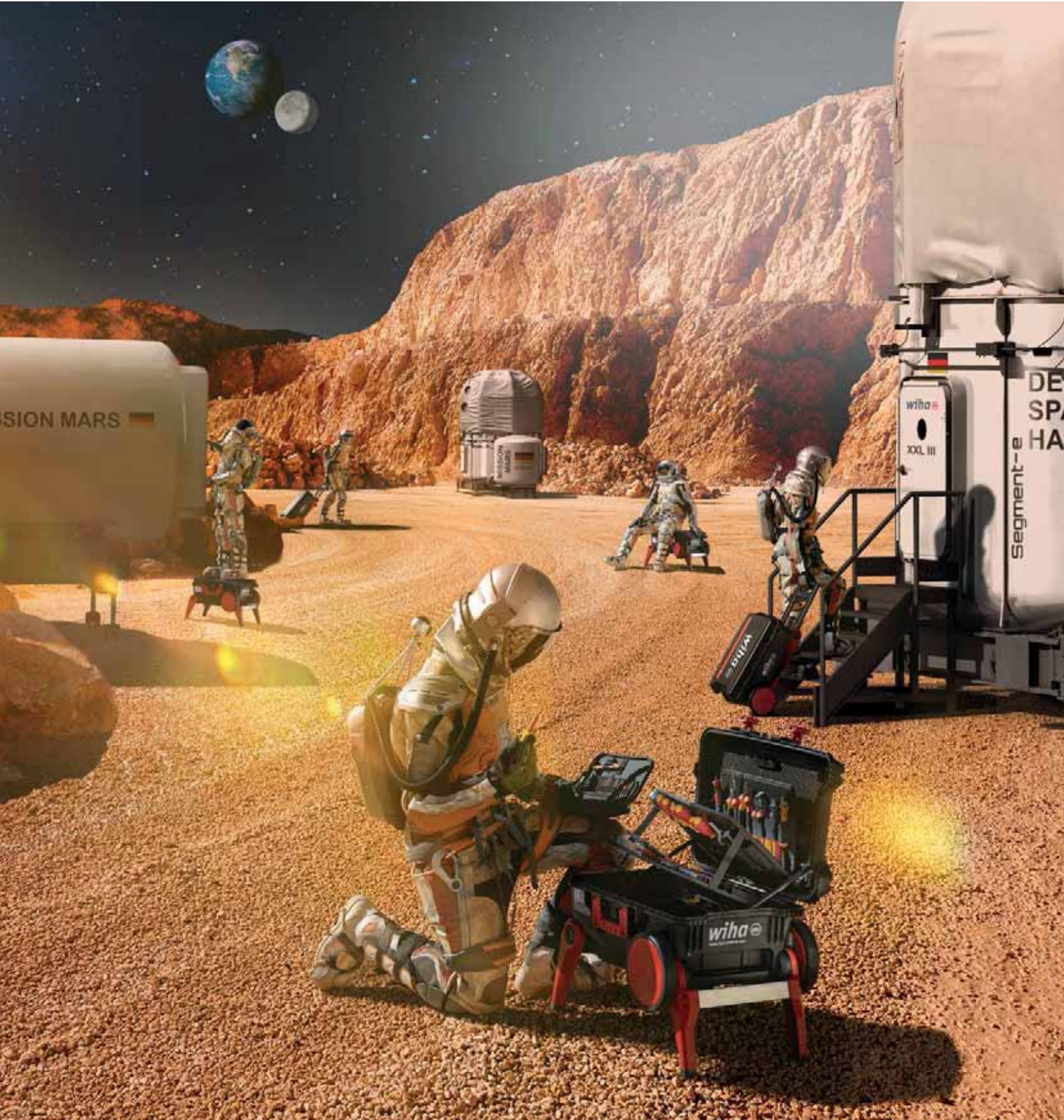

Whether next door or at the most remote site: It's great if the tool you need is quickly at hand. Compact, handy and robust, the Wiha toolbox set ensures access to the tools you require, at any time and in any situation. Specially compiled according to varying requirements and applications, the Wiha toolbox sets have one thing in common: All include high-quality tools in proven Wiha quality, guaranteeing easy and efficient working. Ergonomic in design, durable in material and processing, and safe thanks to rigorous and extensive safety test procedures, Wiha tools prove to be a practical and indispensable companion for the electrician, especially in their toolbox set.

- **Protects your health**

On stairs and rough terrain the trolley moves comfortably and smoothly thanks to its large wheels.

- **Simplifies your work**

When the legs are folded out, the case serves as a stable and slip-proof step for working on higher locations.

- **Increases the quality of your work**

Exact sawing of material at the construction site thanks to a V-shaped incision with a scale in the lid of the case.

- **Protects your health**

Elevated position for removing tools from the case due to the extendable legs.

- **Increases your flexibility**

Ample space for additional tools and lots of storage for small parts and machines.





**Protects your health:** On stairs and rough terrain the trolley moves comfortably and smoothly thanks to its large wheels. **Simplifies your work:** When the legs are folded out, the case serves as a stable and slip-proof step for working on higher locations. **Increases the quality of your work:** Exact sawing of material at the construction site thanks to a V-shaped incision with a scale in the lid of the case. **Protects your health:** Elevated position for removing tools from the case due to the extendable legs. **Protects your health:** Ergonomic handle design makes work easier and prevents occupational illnesses. **Increases your flexibility:** Ample space for additional tools and lots of storage for small parts and machines. **Increases your efficiency:** A comprehensive tool assortment, always having the right tool at hand when needed. **Increases your safety:** Internationally award-winning VDE-insulated tools, each individually tested at 10,000 V AC and approved for use at 1,000 V AC. **Protects your health:** Wiha pliers require less force and reduce pressure on wrists.

## assorted 106-pcs. incl. case

Order-No.



44128

1

## Fastening / Jamming

- Tool set slimVario® electric mixed, 32 pcs. incl. multifunctional bag (43465)  
 slimBit electric bit Slotted 2.0 mm x 75 mm (43115) / 3.5 mm x 75 mm (41159) / 5.5 mm x 75 mm (34581) / 6.5 mm x 75 mm (34582) / slimBit electric bit Phillips PH0 x 75 mm (43116) / PH1 x 75 mm (34583) / PH2 x 75 mm (34584) / slimBit electric bit PlusMinus/Pozidriv SL/PZ1 x 75 mm (34589) / SL/PZ2 x 75 mm (34590) / slimBit electric bit Pozidriv PZ1 x 75 mm (34585) / PZ2 x 75 mm (34586) / slimBit electric bit Hex 3.0 mm x 75 mm (37147) / 4.0 mm x 75 mm (37225) / 5.0 mm x 75 mm (37226) /  
 slimBit electric bit TORX® T10 x 75 mm (35507) / T15 x 75 mm (35508) / T20 x 75 mm (35509) / T25 x 75 mm (36071) /  
 Insulated nut driver insert 1/4" hexagon head 5.0 mm (43089) / 5.5 mm (43090) / 6.0 mm (43091) / 7.0 mm (43092) / 8.0 mm (43093) / 10.0 mm (43095) / 11.0 mm (43096) / 13.0 mm (43098) / slimVario® electric adapter for 1/4" nut driver (43139) /  
 Extension slimVario® electric for slimBits 6.0 mm (43292) / Screwdriver with bit holder SoftFinish® slimVario® electric / Torque screwdriver TorqueVario®-S electric variably adjustable torque limit / Screwdriver with bit holder SoftFinish® electric slimVario Stubby / multifunctional bag  
 XLSelector Y bit set, 25 mm Phillips, Pozidriv, TORX®, 32-pcs., 1/4" C6,3 (41832)  
 1 x Y-Bit 25 mm Phillips 1/4" PH1 / 4 x Y-Bit 25 mm Phillips 1/4" PH2 / 1 x Y-Bit 25 mm Phillips 1/4" PH3 / 2 x Y-Bit 25 mm Pozidriv 1/4" PZ1 / 4 x Y-Bit 25 mm Pozidriv 1/4" PZ2 / 2 x Y-Bit 25 mm Pozidriv 1/4" PZ3 / 2 x Y-Bit 25 mm TORX® 1/4" T10 / 3 x Y-Bit 25 mm TORX® 1/4" T15 / 3 x Y-Bit 25 mm TORX® 1/4" T20 / 3 x Y-Bit 25 mm TORX® 1/4" T25 / 3 x Y-Bit 25 mm TORX® 1/4" T30 / 2 x Y-Bit 25 mm TORX® 1/4" T40 / 1 x Bit holder magnetic 58 mm 1/4" / 1 x XLSelector  
 Universal key with double joint with triangular heads, square heads and double bit 7-9- 5 - 8- 3 - 5 (44001)  
 L-key set in ErgoStar holder hexagonal ball Magicring® 10-pcs. in fluorescent colour (41979)  
 1 x 1.5 mm / 1 x 2.0 mm / 1 x 2.5 mm / 1 x 3.0 mm / 1 x 4.0 mm / 1 x 5.0 mm / 1 x 6.0 mm / 1 x 8.0 mm / 1 x 10.0 mm / 1 x ErgoStar holder  
 Screwdriver SoftFinish® Slotted with one-piece hexagonal blade and solid steel cap 12.0 mm x 200 mm (03231)  
 Screwdriver SoftFinish® electric slimFix Slotted 3.5 mm x 100 mm (35446) / 5.5 mm x 125 mm (35391) / 6.5 mm x 150 mm (35392)  
 Screwdriver SoftFinish® electric slimFix Phillips PH1 x 80 mm (35393) / PH2 x 100 mm (35394)  
 Screwdriver SoftFinish® electric slimFix PlusMinus/Pozidriv SL/PZ1 x 80 mm (36329) / SL/PZ2 x 100 mm (36330)

## Supplying / holding

- Pliers wrench Classic 250 mm, 10" (40923)  
 Needle nose pliers Professional electric with cutting edge straight shape 200 mm, 8" (26727)

## Insulating / crimping

- Stripping tool automatic up to 16 mm<sup>2</sup> in blister pack 200 mm, 8" (42062)  
 Automatic crimp tool for wire-end sleeves hex crimping 210 mm (41246)

## Stripping/ insulating / crimping

- Crimping tools for insulated cable eyes and contacts 220 mm, 0.5 - 6 (33841)  
 Installation pliers TriCut Professional electric 170 mm, 7" (38552)  
 Stripping tool with self-rotating drag blade for round cables 165 mm (44618)

## Trimming / cutting

- Cable cutter Professional electric with switchable opening spring 180 mm, 7" (43660)  
 Professional BiCut® high-performance diagonal cutters with DynamicJoint® Switchable 200 mm, 8" (38191)  
 Professional electric diagonal cutters with DynamicJoint® 160 mm, 6 1/2" (43335)  
 Hacksaw electric insulated with three saw blades 150 mm 280 mm (43125)

## Surveying / marking / measuring / checking

- Single-pole, non-contact volt detector, 12–1,000 V AC Includes two AAA batteries (43797)  
 Flashlight with LED, laser and UV light in blister pack, including 3 AAA batteries 100 - 310 lm (41286)  
 Electrician's Longlife® folding ruler, 2 m metric, 10 segments 15 mm (42068)  
 Electrician's spirit level 40 cm 400 mm (42074)

## Striking / chiselling

- Electrician's hammer with 300 g hammer head in blister pack 283 mm (42071)  
 SoftFinish® dowel ratchet set with dowels with 6 mm round blade pack, 5-pcs. (41289)  
 1 x Dowel ratchet / 2 x 30 mm dowel / 2 x 40 mm dowel

## Various

- SoftFinish® bottle opener Perfect for workshop and kitchen. (04703)

## Storage

- Tool Case XXL III empty (44129)



**Meets your requirements:** Case: robust, large, stable and secure with lid brake. **Lowers your costs:** The right tool protects you from damaging materials and avoids subsequent work. **Increases your safety:** Internationally award-winning VDE-insulated tools, each individually tested at 10,000 V AC and approved for use at 1,000 V AC. **Increases your safety:** Gas-filled shock absorbers hold the lid in all positions and reduce the risk of injury when closing. **Protects your health:** Wiha pliers require less force and reduce pressure on wrists. Ergonomic handle design makes work easier and prevents occupational illnesses. **Protects your health:** Carry belt enables the simple transport of the tool case and keeps hands free for other materials. **Increases your efficiency:** A comprehensive tool assortment, always having the right tool at hand when needed. **Increases your efficiency:** The design and function of the tool trays guarantee quick and easy access to tools. **Increases your flexibility:** Ample space for additional tools and lots of storage for small parts and machines.

## assorted 83-pcs. incl. case

Order-No.



40523

1

**Fastening / Jamming**

- Screwdriver SoftFinish® electric Hex nut driver 5.5 mm x 125 mm (00856) / 7.0 mm x 125 mm (00858) / 8.0 mm x 125 mm (00859) / 10.0 mm x 125 mm (00861)
- ⊖ Screwdriver SoftFinish® electric slimFix Slotted 3.5 mm x 100 mm (35446) / 4.0 mm x 100 mm (35390) / 5.5 mm x 125 mm (35391) / 6.5 mm x 150 mm (35392)
- ⊕ Screwdriver SoftFinish® electric slimFix PlusMinus/Phillips SL/PH1 x 80 mm (35502) / SL/PH2 x 100 mm (35503)
- ⊗ Screwdriver SoftFinish® electric slimFix PlusMinus/Pozidriv SL/PZ1 x 80 mm (36329) / SL/PZ2 x 100 mm (36330)
- ⊕ Screwdriver SoftFinish® electric slimFix Phillips PH1 x 80 mm (35393) / PH2 x 100 mm (35394)
- ⊗ Screwdriver SoftFinish® electric slimFix Pozidriv PZ1 x 1 mm (35395) / PZ2 x 100 mm (35396)
- ⊖ Screwdriver SoftFinish® Slotted with one-piece hexagonal blade and solid steel cap 12.0 mm x 200 mm (03231)
- ⊖⊕⊗⊕ Switch cabinet key cross shape 7.0 mm- 9- 5 - 8- 3 - 5 (36114)
- ⊖⊕⊗⊕ Screwdriver with bit magazine LiftUp electric Phillips, PlusMinus/Pozidriv, slotted with 6 slimBits (38611)  
1 x 3.0 mm / 1 x 4.0 mm / 1 x 5.5 mm / 1 x PH1 / 1 x PH2 / 1 x SL/PZ2
- L-key set in Compact holder Hexagonal ball end matt chrome-plated 10-pcs. (01418)  
1.5 mm / 2.0 mm / 2.5 mm / 3.0 mm / 4.0 mm / 5.0 mm / 6.0 mm / 8.0 mm / 10.0 mm / Compact holder
- ⊖⊕⊗⊕ Bit set XLSelector Standard 25 mm assorted 32-pcs. 1/4" C6,3 (29417)  
1 x 4.5 mm / 1 x 5.5 mm / 1 x 6.5 mm / 2 x PH1 / 4 x PH2 / 1 x PH3 / 2 x PZ1 / 5 x PZ2 / 1 x PZ3 / 2 x T10 / 2 x T15 / 2 x T20 / 3 x T25 / 2 x T30 / 1 x T40 / 1 x Bit holder magnetic 58 mm 1/4" / 1 x XLSelector

**Trimming / cutting**

- ⌘ Professional BiCut® high-performance diagonal cutters with DynamicJoint® Switchable 200 mm, 8" (38191)
- ⌘ Precision mechanic's diagonal cutters Classic with opening spring 125 mm, 5" (36189)
- ⌘ Professional electric diagonal cutters with DynamicJoint® 180 mm, 7" (43340)

**Supplying / holding**

- Water pump pliers Professional electric with push button adjustment 250 mm (37450)
- Needle nose pliers Professional electric with cutting edge curved shape, approx. 40° 200 mm, 8" (26729)
- Combination pliers Professional electric with DynamicJoint® and OptiGrip with extra long cutting edge 180 mm, 7" (26708)
- Needle nose pliers Professional electric with cutting edge straight shape 200 mm, 8" (26727)

**Stripping/ insulating / crimping**

- ⌘ Installation pliers TriCut Professional electric 170 mm, 7" (38552)
- Automatic stripping tool up to 6 mm<sup>2</sup> 190 mm, 7 1/2" (44617)
- Stripping tool with self-rotating drag blade for round cables 165 mm (44618)
- Crimping tools for wire-end sleeves 220 mm, 0.14 - 16 (33844)

**Surveying / marking / measuring / checking**

- Single-pole, non-contact volt detector, 90–1,000 VAC Includes two AAA batteries (43798)
- ⊖ Voltage tester SoftFinish® single-pole, 110-250 volts Slotted transparent, with push-on clip 3.0 mm (34745)
- Folding ruler Longlife 2 m metric, 10 segments 15 mm (27057)
- Control cabinet spirit level 20 cm (36859)

**Storage**

case

## Tool set service technician



**Meets your requirements:** Carefully selected tool ranges for the most common applications. **Increases your safety:** Wiha slim blades ensure unlimited, protected access to deep-set screws. **Increases your safety:** Internationally award-winning VDE-insulated tools, each individually tested at 10,000 V AC and approved for use at 1,000 V AC. **Increases your efficiency:** Compact and space-saving tool bag can be removed from the complete set and used separately.

assorted 31-pcs. incl. bag

9300040

Order-No.



43879

1

#### Fastening / Jamming

- ⊖ Screwdriver SoftFinish® electric slimFix Slotted 3.5 mm x 100 mm (35446) / 5.5 mm x 125 mm (35391)
- ⊕ Screwdriver SoftFinish® electric slimFix Phillips PH1 x 80 mm (35393) / PH2 x 100 mm (35394)
- ⊕ Screwdriver SoftFinish® electric slimFix Pozidriv PZ1 x 1 mm (35395) / PZ2 x 100 mm (35396)
- ⊖ PicoFinish® fine screwdriver Slotted 1.5 mm x 40 mm (42384) / 2.0 mm x 40 mm (42388) / 2.5 mm x 50 mm (42391) / 3.0 mm x 50 mm (42394)
- ⊕ PicoFinish® fine screwdriver Phillips PH00 x 40 mm (42402) / PH0 x 50 mm (42401)
- ⊖ ⊕ ⊕ ⊕ ⊕ Switch cabinet key cross shape 7.0 mm- 9- 5 - 8- 3 - 5 (36114)
- L-key set in Compact holder Hexagonal ball end matt chrome-plated 10-pcs. (01418)  
1.5 mm / 2.0 mm / 2.5 mm / 3.0 mm / 4.0 mm / 5.0 mm / 6.0 mm / 8.0 mm / 10.0 mm / Compact holder

#### Trimming / cutting

- ⌘ Professional electric diagonal cutters with DynamicJoint® 160 mm, 6 1/2" (43335)
- ⌘ Electronic needle nose pliers narrow, short head straight form 135 mm, 5 1/3" (26801)
- ⌘ Electronic diagonal cutters wide, pointed head and wire trapping spring without bevelled edge 130 mm, 5 1/8" (26825)

#### Supplying / holding

- Needle nose pliers Professional electric with cutting edge straight shape 200 mm, 8" (26727)

#### Stripping/ insulating / crimping

- Automatic stripping tool up to 6 mm<sup>2</sup> 190 mm, 7 1/2" (44617)
- Stripping tool with self-rotating drag blade for round cables 165 mm (44618)

#### Surveying / marking / measuring / checking

- ⊖ Voltage tester SoftFinish® single-pole, 110-250 volts Slotted transparent, with push-on clip 3.0 mm (34745)

#### Storage

- Toolbag (mechanics/electricians)



**Simplifies your work:** All tools securely arranged in a robust, orderly bag. **Increases your efficiency:** Space saved thanks to extensive interchangeable bit system and nut driver inserts. **Protects your material:** Fully insulated nut driver reduces the risk of short circuits. **Offers you full protection:** Each tool individually tested at 10,000 V AC and approved for 1,000 V AC. **Increases your safety:** Wiha slimBits ensure good, protected access to deep-set screws.



mixed, 32 pcs. incl. multifunctional bag

7209NK2002

Order-No.



43465

1

#### Fastening / Jamming

- ⊖ slimBit electric bit Slotted 2.0 mm x 75 mm (43115) / 3.5 mm x 75 mm (41159) / 5.5 mm x 75 mm (34581) / 6.5 mm x 75 mm (34582)
- ⊕ slimBit electric bit Phillips PH0 x 75 mm (43116) / PH1 x 75 mm (34583) / PH2 x 75 mm (34584)
- ⊕⊖ slimBit electric bit PlusMinus/Pozidriv SL/PZ1 x 75 mm (34589) / SL/PZ2 x 75 mm (34590)
- ⊕⊖ slimBit electric bit Pozidriv PZ1 x 75 mm (34585) / PZ2 x 75 mm (34586)
- slimBit electric bit Hex 3.0 mm x 75 mm (37147) / 4.0 mm x 75 mm (37225) / 5.0 mm x 75 mm (37226)
- ⊕⊖ slimBit electric bit TORX® T10 x 75 mm (35507) / T15 x 75 mm (35508) / T20 x 75 mm (35509) / T25 x 75 mm (36071)
- Insulated nut driver insert 1/4" hexagon head 5.0 mm (43089) / 5.5 mm (43090) / 6.0 mm (43091) / 7.0 mm (43092) / 8.0 mm (43093) / 10.0 mm (43095) / 11.0 mm (43096) / 13.0 mm (43098)
- slimVario® electric adapter for 1/4" nut driver (43139)
- Extension slimVario® electric for slimBits 6.0 mm (43292)
- Screwdriver with bit holder SoftFinish® slimVario® electric
- Torque screwdriver TorqueVario®-S electric variably adjustable torque limit
- Screwdriver with bit holder SoftFinish® electric slimVario Stubby

#### Storage

multifunctional bag

Manufactured acc. to IEC 60900.

Functional bag



**Simplifies your work:** Robust, orderly bag offers a great deal of space to store Wiha tools. **Increases your efficiency:** Opened bag acts as a workbench stand to remove tools easily.

Empty

7209NRW

Order-No. 

43474 1

Tool set electrician



**Increases your efficiency:** Compact and space-saving tool range. **Protects your health:** With the patented SoftFinish® handle design, ensuring work is kind to hands and muscles. Recommended by doctors and therapists at German Campaign for Healthier Backs. **Offers you full protection:** Each tool individually tested at 10,000 V AC and approved for 1,000 V AC.

Screwdriver, diagonal cutters, 7-pcs. incl. tool pouch

9300018

Order-No. 

33969 1

Fastening / Jamming

 Screwdriver SoftFinish® electric Slotted 3.5 mm x 100 mm (00822) / 4.5 mm x 125 mm (00824) / 5.5 mm x 125 mm (00826)

 Screwdriver SoftFinish® electric Phillips PH1 x 80 mm (00847) / PH2 x 100 mm (00848)

Trimming / cutting

 Professional electric diagonal cutters with DynamicJoint® 160 mm, 6 1/2" (43335)

Storage

Tool kit

Tool set electrician



**Increases your efficiency:** Compact and space-saving tool range.  
**Offers you full protection:** Each tool individually tested at 10,000 V AC and approved for 1,000 V AC.

screwdriver, heavy-duty diagonal cutters, 6-pcs.  
 incl. tool folder

Z99000206

Order-No.  1  
 26755

**Fastening / Jamming**

- ⊖ Screwdriver SoftFinish® electric Slotted 3.5 mm x 100 mm (00822) / 5.5 mm x 125 mm (00826)
- ⊕ Screwdriver SoftFinish® electric Phillips PH2 x 100 mm (00848)

**Supplying / holding**

- Needle nose pliers Professional electric with cutting edge straight shape 200 mm, 8" (26727)

**Trimming / cutting**

- ✂ Professional electric diagonal cutters with DynamicJoint® 160 mm, 6 1/2" (43335)

**Storage**

Tool kit

Tool set electrician



**Increases your efficiency:** Compact and space-saving tool range.  
**Protects your health:** With the patented SoftFinish® handle design, ensuring work is kind to hands and muscles. Recommended by doctors and therapists at German Campaign for Healthier Backs. **Offers you full protection:** Each tool individually tested at 10,000 V AC and approved for 1,000 V AC. **Increases your safety:** Wiha slim blades ensure unlimited, protected access to deep-set screws.

Screwdriver, heavy-duty diagonal cutters, 8-pcs.  
 incl. tool pouch

9300031

Order-No.  1  
 38020

**Fastening / Jamming**

- ⊖ Screwdriver SoftFinish® electric slimFix Slotted 3.5 mm x 100 mm (35446) / 4.0 mm x 100 mm (35390) / 5.5 mm x 125 mm (35391)
- ⊕ Screwdriver SoftFinish® electric slimFix Phillips PH2 x 100 mm (35394)
- ⊕ Screwdriver SoftFinish® electric slimFix Pozidriv PZ2 x 100 mm (35396)
- ⊕ Screwdriver SoftFinish® electric slimFix PlusMinus/Pozidriv SL/PZ2 x 100 mm (36330)

**Supplying / holding**

- ✂ Heavy-duty diagonal cutters Professional electric with DynamicJoint® with switchable opening spring 160 mm, 6 1/2" (40921)

**Storage**

Tool kit

## Tool set electrician



**Meets your requirements:** Carefully selected tool ranges for the most common applications. **Increases your efficiency:** Compact and space-saving tool range. **Protects your health:** With the patented SoftFinish® handle design, ensuring work is kind to hands and muscles. Recommended by doctors and therapists at German Campaign for Healthier Backs. **Increases your safety:** Internationally award-winning VDE-insulated tools, each individually tested at 10,000 V AC and approved for use at 1,000 V AC.

**Mixed, 13-pcs. incl. tool pouch**

9300025

Order-No.



36389

1

**Fastening / Jamming**

- ⊖ Screwdriver SoftFinish® electric slimFix Slotted 3.5 mm x 100 mm (35446) / 4.5 mm x 125 mm (35501) / 5.5 mm x 125 mm (35391)
- ⊕ Screwdriver SoftFinish® electric slimFix Pozidriv PZ1 x 1 mm (35395) / PZ2 x 100 mm (35396)

**Trimming / cutting**

- ✂ Cable cutter Professional electric with switchable opening spring 210 mm, 8 1/4" (43662)

**Supplying / holding**

- Needle nose pliers Professional electric with cutting edge straight shape 200 mm, 8" (26727)
- ✂ Heavy-duty diagonal cutters Professional electric with DynamicJoint® with switchable opening spring 180 mm, 7" (41274)

**Stripping/ insulating / crimping**

- Automatic stripping tool up to 6 mm<sup>2</sup> 190 mm, 7 1/2" (44617)
- Stripping tool with self-rotating drag blade for round cables 165 mm (44618)

**Surveying / marking / measuring / checking**

- ⊖ Voltage tester SoftFinish® single-pole, 110-250 volts Slotted transparent, with push-on clip 3.0 mm (34745)
- Folding ruler LongLife Plus 2 m metric, 10 segments 15 mm (27059)

**Storage**

Tool kit

## Tool set electrician

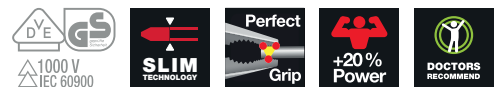

**Meets your requirements:** Carefully selected tool ranges for the most common applications. **Increases your efficiency:** Compact and space-saving tool range. **Protects your health:** With the patented SoftFinish® handle design, ensuring work is kind to hands and muscles. Recommended by doctors and therapists at German Campaign for Healthier Backs. **Increases your safety:** With slim blades ensure unlimited, protected access to deep-set screws. **Increases your safety:** Internationally award-winning VDE-insulated tools, each individually tested at 10,000 V AC and approved for use at 1,000 V AC.

**Mixed, 33-pcs. incl. tool pouch**

9300035

Order-No.



41241

1

**Fastening / Jamming**

- ⊖ Screwdriver SoftFinish® electric slimFix Slotted 3.5 mm x 100 mm (35446) / 5.5 mm x 125 mm (35391)
- ⊕ Screwdriver SoftFinish® electric slimFix Phillips PH1 x 80 mm (35393) / PH2 x 100 mm (35394)
- ⊕⊖ Screwdriver with bit magazine magnetic assorted with 8 bits, 1/4" (32901)  
1 x 6.5 mm / 1 x PH1 / 1 x PH2 / 1 x PH3 / 1 x PZ2 / 1 x T15 / 1 x T20 / 1 x T25
- ⊕⊖ Bit set FlipSelector Standard 25 mm Phillips, Pozidriv, TORX®, 14-pcs., 1/4" C6,3 (39040)  
2 x PH2 / 1 x PZ1 / 2 x PZ2 / 1 x PZ3 / 1 x T10 / 1 x T15 / 1 x T20 / 1 x T25 / 1 x T30 / 1 x T40 / 1 x Bit holder magnetic 58 mm 1/4" / 1 x FlipSelector

**Trimming / cutting**

- ✂ Professional electric diagonal cutters with DynamicJoint® 160 mm, 6 1/2" (43335)

**Supplying / holding**

- Combination pliers Professional electric with DynamicJoint® and OptiGrip with extra long cutting edge 180 mm, 7" (26708)

**Stripping/ insulating / crimping**

- Automatic stripping tool up to 6 mm<sup>2</sup> 190 mm, 7 1/2" (44617)

**Surveying / marking / measuring / checking**

- ⊖ Voltage tester SoftFinish® single-pole, 110-250 volts Slotted transparent, with push-on clip 3.0 mm (34745)
- Folding ruler Longlife 2 m metric, 10 segments 15 mm (27057)

**Storage**

Tool kit



**Simplifies your work:** Free hands and no damage to work trousers thanks to pouch attached to belt. **Increases your safety:** Wiha slim blades ensure unlimited, protected access to deep-set screws. **Increases your safety:** Internationally award-winning VDE-insulated tools, each individually tested at 10,000 V AC and approved for use at 1,000 V AC. **Protects your health:** With the patented SoftFinish® handle design, ensuring work is kind to hands and muscles. Recommended by doctors and therapists at German Campaign for Healthier Backs. **Increases your efficiency:** All main tools quickly available, always at hand.

#### mixed, 18-pcs. incl. belt pouch

930050005

Order-No.



44574

1

#### Stripping/ insulating / crimping

✂ Installation pliers TriCut Professional electric 170 mm, 7" (38552)

#### Supplying / holding

● Needle nose pliers Professional electric with cutting edge straight shape 200 mm, 8" (26727)

#### Trimming / cutting

✂ Professional electric diagonal cutters with DynamicJoint® 140 mm, 5 1/2" (43326)

#### Surveying / marking / measuring / checking

Electrician's Longlife® folding ruler, 2 m metric, 10 segments 15 mm (42068)

Flashlight with LED, laser and UV light in blister pack, including 3 AAA batteries 100 - 310 lm (41286)

⊖ Voltage tester SoftFinish® single-pole, 110-250 volts Slotted transparent, with push-on clip 3.0 mm (34745)  
measure tape 5 m

#### Fastening / Jamming

⊖ PicoFinish® electric fine screwdriver Slotted 1.5 mm x 50 mm (42374) / 2.5 mm x 65 mm (42376) / 3.5 mm x 100 mm (35446) / 4.0 mm x 100 mm (35390) / 5.5 mm x 125 mm (35391)

⊕ PicoFinish® electric fine screwdriver Phillips PH00 x 50 mm (42379) / PH0 x 65 mm (42378)

⊕ Screwdriver SoftFinish® electric slimFix Pozidriv PZ1 x 1 mm (35395)

⊕ Screwdriver SoftFinish® electric slimFix PlusMinus/Pozidriv SL/PZ2 x 100 mm (36330)

⊕ Screwdriver SoftFinish® electric slimFix TORX® T10 x 100 mm (36536)

#### Storage

Tool Belt Pouch

## Ratchet wrench set insulated 1/2"



**Increases your efficiency:** Various usage options for all fastening procedures and application areas. **Increases your flexibility:** Adjustable right or left rotation through switching lever. **Protects your material:** Fully insulated tool reduces the risk of short circuits. **Offers you full protection:** Each tool individually tested at 10,000 V AC and approved for 1,000 V AC. **Improved access:** Deep-set screws can be reached easily.

21-pcs. incl. case

7208NK2001

Order-No.



43024

1

## Fastening / Jamming

- T-handle insulated for nut driver (43063)
- Ratchet wrench insulated for nut drivers Switchable 1/2" (43053)
- Insulated extension 1/2" for nut driver inserts, insulated 250 mm (43056)
- Insulated extension 1/2" for nut driver inserts, insulated 125 mm (43055) / 10.0 mm (43077) / 11.0 mm (43078) / 12.0 mm (43079) / 13.0 mm (43080) / 14.0 mm (43081) / 17.0 mm (43082) / 19.0 mm (43083) / 22.0 mm (43084) / 24.0 mm (43085) / 27.0 mm (43086) / 32.0 mm (43087)
- Insulated nut driver insert 1/2" hexagon head 4.0 mm (43100) / 5.0 mm (43101) / 6.0 mm (43102) / 8.0 mm (43103) / 10.0 mm (43104)

## Storage

case

Manufactured according to EN/IEC 60900.  
DIN EN IEC 60900

## Ratchet wrench set insulated 3/8"



**Increases your efficiency:** Various usage options for all fastening procedures and application areas. **Increases your flexibility:** Adjustable right or left rotation through switching lever. **Protects your material:** Fully insulated tool reduces the risk of short circuits. **Offers you full protection:** Each tool individually tested at 10,000 V AC and approved for 1,000 V AC. **Improved access:** Deep-set screws can be reached easily.

21-pcs. incl. case

7207NK2001

Order-No.



43023

1

## Fastening / Jamming

- T-handle insulated for nut driver (43062)
- Ratchet wrench insulated for nut drivers Switchable 3/8" (43052)
- Insulated extension 3/8" for nut driver inserts, insulated 125 mm (43057)
- Insulated extension 3/8" for nut driver inserts, insulated 250 mm (43058)
- Insulated nut driver insert 3/8" hexagon head 8.0 mm (43065) / 10.0 mm (43066) / 11.0 mm (43067) / 12.0 mm (43068) / 13.0 mm (43069) / 14.0 mm (43070) / 16.0 mm (43071) / 17.0 mm (43072) / 18.0 mm (43073) / 19.0 mm (43074) / 21.0 mm (43075) / 22.0 mm (43076)
- Insulated nut driver insert 3/8" hexagon head 4.0 mm (43105) / 5.0 mm (43106) / 6.0 mm (43107) / 8.0 mm (43108)

## Storage

case

DIN EN IEC 60900

**Ratchet wrench set insulated, 1/4"**



**Increases your efficiency:** Various usage options for all fastening procedures and application areas. **Offers you full protection:** Each tool individually tested at 10,000 V AC and approved for 1,000 V AC. **Increases your flexibility:** Adjustable right or left rotation through switching lever. **Protects your material:** Fully insulated tool reduces the risk of short circuits.

21-pcs. in case

7209NK2001

Order-No.



43025

1

**Fastening / Jamming**

Ratchet wrench insulated for nut drivers 1/4" switchable (43054)

○ Insulated extension 1/4" for nut driver inserts, insulated 75 mm (43059) / 150 mm (43060)

○ Insulated nut driver insert 1/4" hexagon head 4.0 mm (43088) / 5.0 mm (43089) / 5.5 mm (43090) / 6.0 mm (43091) / 7.0 mm (43092) / 8.0 mm (43093) / 9.0 mm (43094) / 10.0 mm (43095) / 11.0 mm (43096) / 12.0 mm (43097) / 13.0 mm (43098) / 14.0 mm (43099)

● Insulated nut driver insert 1/4" internal hexagon 3.0 mm (43109) / 4.0 mm (43110) / 5.0 mm (43111) / 6.0 mm (43112) / 8.0 mm (43113)

**Storage**

case

IEC 60900

**Single open-end spanner set, insulated 6-32 mm**



**Protects your material:** Fully insulated tool reduces the risk of short circuits. **Offers you full protection:** Each tool individually tested at 10,000 V AC and approved for 1,000 V AC.

21-pcs. incl. case

5590NT20

Order-No.



43022

1

**Fastening / Jamming**

Single, insulated open-end spanner 6.0 mm, 90 mm (43026) / 7.0 mm, 90 mm (43027) / 8.0 mm, 100 mm (43028) / 9.0 mm, 100 mm (43029) / 10.0 mm, 110 mm (43030) / 11.0 mm, 110 mm (43031) / 12.0 mm, 130 mm (43032) / 13.0 mm, 135 mm (43033) / 14.0 mm, 145 mm (43034) / 15.0 mm, 150 mm (43035) / 16.0 mm, 160 mm (43036) / 17.0 mm, 160 mm (43037) / 18.0 mm, 175 mm (43038) / 19.0 mm, 175 mm (43039) / 22.0 mm, 195 mm (43040) / 24.0 mm, 225 mm (43041) / 27.0 mm, 250 mm (43042) / 30.0 mm, 290 mm (43043) / 32.0 mm, 310 mm (43044)

○ Adjustable spanner electric Adjustable between 0-30 mm 250 mm (43061)

**Storage**

case

DIN EN IEC 60900



**Increases your efficiency**

Wiha screwdrivers offer an optimal balance between power and control thanks to their unique handle size concept.

**Saves money**

By using the correct torque value, torque tools protect against material damage and reworking.

**Protect your health**

The patented and multiple award-winning Wiha SoftFinish® handle size concept prevents occupational illnesses as work is kind to hands and muscles. Recommended by German doctors and therapists from the AGR! (Healthy back association)

**Offers you full protection**

Each tool individually tested at 10,000 V AC and approved for 1,000 V AC.

**Increases your safety**

Wiha slim tools ensure full and fully-insulated access to lowlying screws.

# Fastening / jamming

## We have the know-how at the tip of our fingers.

The ergonomic quality of a tool is never quite so apparent as when fastening and clamping. Under the motto "A grasp on turning" Wiha presents an innovative handle size concept which breaks new ground in terms of individual user comfort. Many commonly available screwdrivers are not designed to meet the needs of users. This results in disadvantages in guiding the tool as well as in transmitting force while fastening. In contrast, the Wiha SoftFinish® concept works with four different handle sizes: Thus, each handle has a perfectly correlated ratio of guidance, speed and torque for any task. The Wiha slimTECHNOLOGY offers additional comfort, permitting unrestricted access to each screw with 33 % slimmer blades. The speedE® II e-screwdriver proves itself to be the ideal tool for virtually every screw-fastening task. Whether handling delicate fastenings, long screws or an extremely large number of screws, professionals can do their job faster while working with the e-screwdriver.

**"The speedE® II is my most trusted partner in my daily work. Especially at the end of a long workday, it not only saves energy but also time, as I can work significantly faster with it. In addition, it has two power transmission levels\* and due to the different colours of the bits, I immediately know which one to use without damaging the material. Thanks to the speedE® II, working error-free and gently is no longer the exception but the rule."**  
 Simon Furrer, WorldSkills 2017 World Champion in Abu Dhabi, Industrial Control Category



# Fast has never been this unique.

**THE  
ORIGINAL  
FROM WIHA**

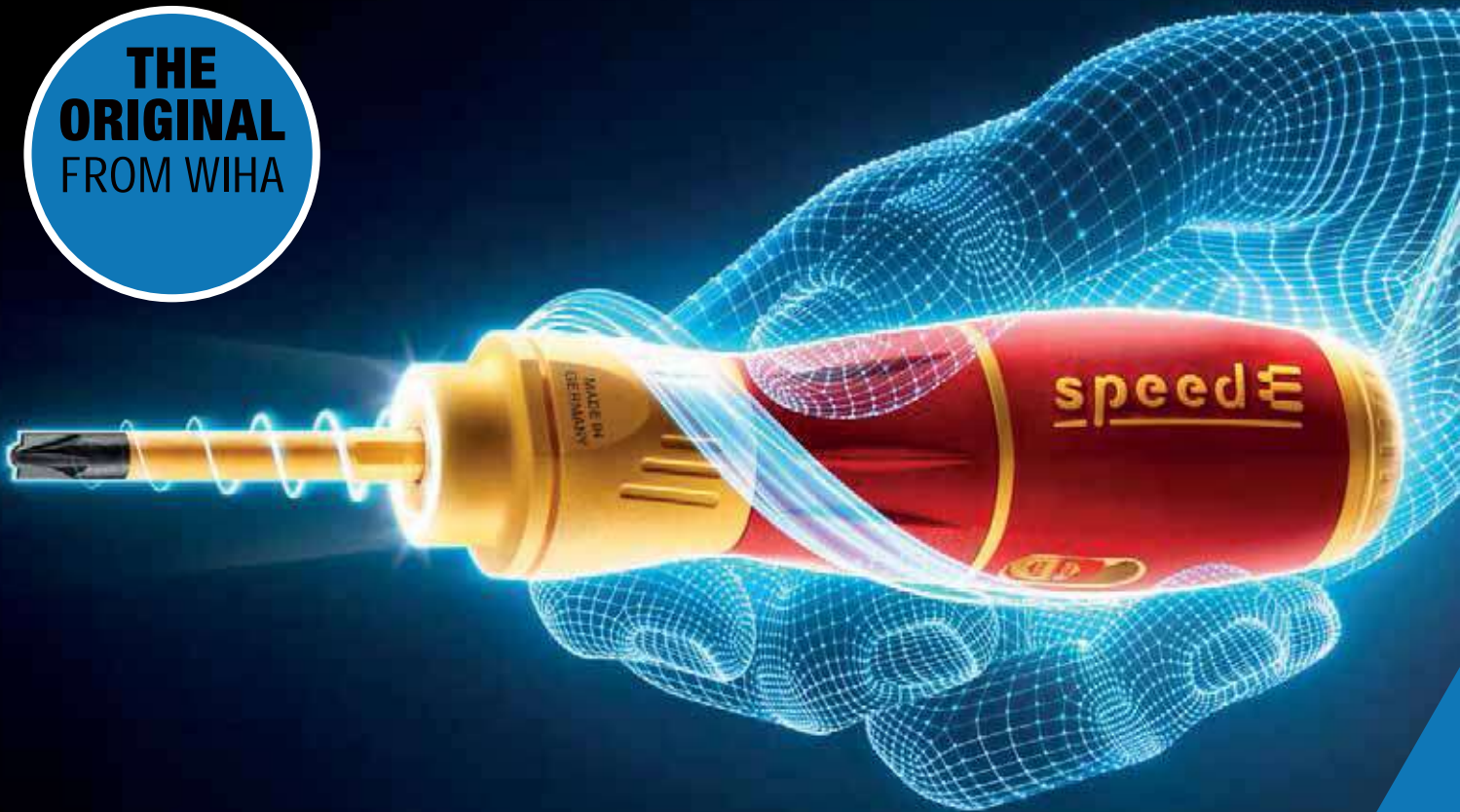

- **Increases your speed**

Work completed 3 times as fast thanks to the electric drive.

- **Protect your health**

Gentle on hands and muscles. Recommended by doctors and therapists at the German Campaign for Healthier Backs!

- **Offers you full protection**

slimBits tested at 10,000 V AC and approved for 1,000 V AC.

- **Protects your material**

Electric screw fastening with protective function to prevent damage to materials.

**NEW**  
**MORE  
POWER**

Several fastenings per day, hundreds of fastenings per week. Professional craftspeople invest a great amount of time and energy in recurring fastening tasks. The resulting pain in wrists is the body's natural reaction. Thanks to the electric drive of the e-screwdriver speedE® II, joints and tendons are protected, especially during continuous use. In addition, the required time is reduced to one-third. An extra highlight of the speedE® II is the integrated material function. Sensitive fastenings, for example, plastic socket covers, must not be tightened too hard or the material will be damaged. In such cases, the speedE II automatically switches off at 0.4 Nm and gives the user full control to carefully carry out the final fastening by hand. If there are fastening tasks that require more force, the second generation speedE® offers the option of increasing the electric force to 1.0 Nm via a sliding switch. The colour of the slimBits serves as an aid for adjusting the correct force level to the respective application. The red slimBits with the smaller profiles are used in the red slide position, while the yellow Power SlimBits with the larger profiles indicate that in this case, the more powerful yellow slide position can be used. However, if more force is required, the speedE® can be manually used up to 12 Nm without incurring any damage. During the fastening, the integrated LED light provides permanent illumination for an optimal view of

the screw. This way, in poorly lit work environments the powerful LED can be used as a flashlight by tapping on the ring switch. The enlarged ring switch and smooth rotation ensure even easier handling. Thanks to the combination of facilitated handling and the ergonomic SoftFinish® handle design, the e-screwdriver speedE® II is recommended by doctors and therapists from the German Campaign for Healthier Backs. The set contains both a red and yellow slimBit, a USB battery charger, as well as two standard 18500 batteries, which ensures continuous working.



E-screwdriver, speedE® II electric



**Increases your speed:** Work completed 3 times as fast thanks to the electric drive. **Protects your material:** Electric screw fastening with protective function to prevent damage to materials. **Offers you full protection:** slimBits tested at 10,000 V AC and approved for 1,000 V AC. **Increases your efficiency:** 100% compatible with the Wiha Electric Vario family. **Makes handling easier:** Unique ring work allows operation in all working positions. **Simplifies your work:** Maximum illumination of the working area thanks to the LED ring light. **Protects your health:** Gentle on hands and muscles. Recommended by doctors and therapists at the German Campaign for Healthier Backs! **Meets your requirements:** Quality and robustness made in Germany.



<b>7 pcs with slimBits, batteries and USB charger in L Boxx Mini</b>		591T101
Order-No.		
44318	1	
<b>Fastening / Jamming</b>		
	Bit Power slimBit electric - SL/PZ2	
	slimBit electric bit Slotted 3.5 mm x 75 mm (41159)	
	E-screwdriver handle speedE® II	
<b>Various</b>		
	Charger for battery type 18500 Li-Ion with USB	
	Battery set, 18500 Li-Ion 2 units in box (41914)	

E-screwdriver, starter set speedE® I electric



**Increases your speed:** Work twice as fast thanks to three-step process. **Protects your material:** Electric screw fastening with protection function to prevent damage to materials (max. 0.4 Nm). **Increases your control:** Fixing by hand with a deft touch. **Offers you full protection:** slimBits tested at 10,000 V AC and approved for 1,000 V AC. **Protects your health:** Gentle on hands and muscles. Recommended by doctors and therapists at the German Campaign for Healthier Backs!



<b>4-pcs. incl. slimBit, battery and USB charger</b>		590T401
Order-No.		
44351	1	
<b>Fastening / Jamming</b>		
	slimBit electric bit PlusMinus/Pozidriv SL/PZ1 x 75 mm (34589)	
	E-screwdriver handle speedE®	
<b>Various</b>		
	Charger for battery type 18500 Li-Ion with USB	
	18500 Li-Ion battery	

## Belt pouch



**Simplifies your work:** Offers room for a Wiha e-screwdriver as well as 4 slimBits. **Simplifies your work:** Eyelet at the bottom of the pouch allows storage of the e-screwdriver with inserted bit. **Makes handling easier:** Simple to hook on to work trousers thanks to the high quality clip holder.

for e-screwdriver speedE®

7209NEX

Order-No. 

44367 1

## INFOBOX: Wiha speedE® II



### E-screwdriver, speedE® II electric

- 3x faster than manual fastening.
- Made in Germany.
- Safe working up to 1,000 V AC.
- Manual torque fastening up to 12 Nm.
- Powerful ring LED light.
- Replaceable standard battery.
- Kind to hands and muscles.
- Fully compatible with the Wiha slimBit system.
- Thanks to the integrated material protection function, the electric assistance stops automatically at 0.4 Nm.

Battery set, 18500 Li-ion



2 units in box

599001

Order-No.



41914

6

Power plug



EU

599006

Order-No.



44363

1

speedE power plug EU

Charger for 18500 Li-ion batteries



with USB and Europlug

599002

Order-No.



41915

1

speedE power plug EU

Power plug



UK

599007

Order-No.



44364

1

speedE power plug UK

slimBit electric bit set







Power slimBit electric bit set











Fastening / jamming





**Makes handling easier:** Compact slimBit box with easy access and an optimal view of profiles. **Offers you full protection:** Each tool individually tested at 10,000 V AC and approved for 1,000 V AC. **Increases your safety:** Wiha slimBits ensure good, protected access to deep-set screws.

**Increases your safety:** Wiha Power slimBits ensure good, protected access to deep-set screws. **Makes handling easier:** Compact slimBit box with easy access and an optimal view of profiles. **Offers you full protection:** Each tool individually tested at 10,000 V AC and approved for 1,000 V AC.

<b>Slotted, Phillips, Pozidriv 7-pcs. incl. SlimBit box</b>	SB2831B903
Order-No.	
43160	1
 2.0 mm / 2.5 mm	
 PH0 / PH1	
 PZ0 / PZ1	
slimBit box	
Tested according to IEC 60900.	

<b>Slotted, hex, 7-pcs. incl. slimBit box</b>	SB2831PB901
Order-No.	
44107	1
 Bit Power slimBit electric - Slotted 6.5	
 Bit Power slimBit electric - Innensechskant 2.5 / Bit Power slimBit electric - Innensechskant 3 / Bit Power slimBit electric - Innensechskant 4 / Bit Power slimBit electric - Innensechskant 5 / Bit Power slimBit electric - Innensechskant 6	
slimBit box	
Tested according to IEC 60900.	

<b>Mixed 7-pcs. incl. slimBit box</b>	SB2831B904
Order-No.	
44366	1
 1 x 2.5 mm	
 1 x PH1	
 1 x PZ1	
 1 x SL/PZ1	
 1 x T9 / 1 x T10	
1 x slimBit box	
Tested according to IEC 60900.	

<b>Mixed 7-pcs. incl. slimBit box</b>	SB2831PB900
Order-No.	
44106	1
 Bit Power slimBit electric - Slotted 5.5	
 Bit Power slimBit electric - PH2	
 Bit Power slimBit electric - SL/PZ2	
 Bit Power slimBit electric - T15 / Bit Power slimBit electric - T20 / Bit Power slimBit electric - T25	
slimBit box	
Tested according to IEC 60900.	

There are moments when you need to control  
your power.



Power is good. Controlled power is better. The certified Wiha VDE torque screwdriver systems TorqueVario®-S and TorqueVario®-S TR and the insulated torque keys combine precision with safety. When reaching the desired torque, a click signal can be clearly felt and heard. With a release accuracy of +/-6% of the set scale value, Wiha VDE screwdrivers meet the accuracy requirements of EN ISO 6789. With two directions of rotation, this insulated torque key is ideal for powerful, yet controlled tightening. Uncompromising safety is ensured in production and testing according to IEC 60900, VDE/GS certification and testing of single parts at 10,000 V AC.

- **Increases your efficiency**  
Using the correct torque prevents from rework and damaged material.
- **Lowers your costs**  
The correct torque protects you from warranty claims.
- **Offers you full protection**  
Each tool individually tested at 10,000 V AC and approved for 1,000 V AC.
- **Increases your safety**  
Wiha slimBits grant unhindered, fully insulated access to deeplying screws.





## Torque screwdriver set TorqueVario®-S electric

1000 V  
IEC 60900

**Meets your requirements:** Variably adjustable torque covers a wide range of applications. **Simplifies your work:** All tools securely arranged in a robust, orderly bag. **Increases your efficiency:** The correct torque protects material from damage and means no follow-up work. **Protects your health:** With the patented SoftFinish® handle design, ensuring work is kind to hands and muscles. Recommended by doctors and therapists at German Campaign for Healthier Backs. **Lowers your costs:** The correct torque protects you from warranty claims. **Offers you full protection:** Each tool individually tested at 10,000 V AC and approved for 1,000 V AC. **Increases your safety:** Wiha slimBits ensure good, protected access to deep-set screws.

## 0,8-5,0 Nm mixed, variably adjustable torque limit, 19 pcs. incl. folding bag

2872T18

Order-No.



36791

1

- 1 x Torque screwdriver TorqueVario®-S electric variably adjustable torque limit
- 1 x Setting tool for torque screwdriver with long handle
- 1 x Adapter TorqueVario-S electric for slimBits
- ┌ 1 x 2.5 mm / 1 x 3.5 mm / 1 x 5.5 mm / 1 x 6.5 mm
- ⊕ 1 x PH1 / 1 x PH2
- ⊕ 1 x PZ1 / 1 x PZ2
- ⊕ 1 x SL/PZ1 / 1 x SL/PZ2
- ⊕ 1 x T9 / 1 x T10 / 1 x T15 / 1 x T20 / 1 x T25
- 1 x Folding bag

DIN EN ISO 6789.

Manufactured acc. to IEC 60900.



## Torque screwdriver set TorqueVario®-S electric

1000 V  
IEC 60900

**Meets your requirements:** Variably adjustable torque covers a wide range of applications. **Simplifies your work:** All tools securely arranged in a robust, orderly bag. **Increases your efficiency:** The correct torque protects material from damage and means no follow-up work. **Protects your health:** With the patented SoftFinish® handle design, ensuring work is kind to hands and muscles. Recommended by doctors and therapists at German Campaign for Healthier Backs. **Lowers your costs:** The correct torque protects you from warranty claims. **Offers you full protection:** Each tool individually tested at 10,000 V AC and approved for 1,000 V AC. **Increases your safety:** Wiha slimBits ensure good, protected access to deep-set screws.

**0,8-5,0 Nm mixed, variably adjustable torque limit, 14 pcs. incl. folding bag**

2872T13

Order-No.



40674

1

- 1 x Torque screwdriver TorqueVario®-S electric variably adjustable torque limit
- 1 x Setting tool for torque screwdriver with long handle
- 1 x Screwdriver with bit holder SoftFinish® electric slimVario for slimBits
- Adapter TorqueVario-S electric for slimBits
- ┘ 1 x 2.5 mm / 1 x 3.5 mm / 1 x 5.5 mm
- ⊕ 1 x PH1 / 1 x PH2
- ⊕ 1 x PZ1 / 1 x PZ2
- ⊕ 1 x SL/PZ1 / 1 x SL/PZ2
- 1 x Folding bag

DIN EN ISO 6789.

Manufactured acc. to IEC 60900.

## Torque key, electric



**Meets your requirements:** Variably adjustable torque covers a wide range of applications. **Increases your efficiency:** The correct torque protects material from damage and means no follow-up work. **Lowers your costs:** The correct torque protects you from warranty claims. **Offers you full protection:** Each tool individually tested at 10,000 V AC and approved for 1,000 V AC.

## for nut drivers, adjustable torque limit

2822

Order-No.	⌀"	Nm					
43126	1/4"	5 - 25	38	36	288	200	1
44163	3/8"	5 - 25	38	36	290	200	1

## TorqueVario®-S electric nut driver insert 1/4" set



**Simplifies your work:** All tools securely arranged in a robust, orderly bag. **Increases your flexibility:** Nut driver inserts can be used with speedE®, slimVario® and TorqueVario®-S tools thanks to the enclosed adapters. **Protects your material:** Fully insulated nut driver reduces the risk of short circuits. **Offers you full protection:** Each tool individually tested at 10,000 V AC and approved for 1,000 V AC.

## Mixed, 11-pcs., incl. adapters and folding bag

7209NK2003

Order-No.	
43466	1
	1 x slimVario® electric adapter for 1/4" nut driver / 1 x Adapter TorqueVario-S electric for 1/4" nut driver
	1 x 5.0 mm / 1 x 5.5 mm / 1 x 6.0 mm / 1 x 7.0 mm / 1 x 8.0 mm / 1 x 10.0 mm / 1 x 11.0 mm / 1 x 13.0 mm
	1 x Folding bag

Torque screwdriver set TorqueVario®-S electric



**Increases your efficiency:** The correct torque protects material from damage and means no follow-up work. **Lowers your costs:** The correct torque protects you from warranty claims. **Offers you full protection:** Each tool individually tested at 10,000 V AC and approved for 1,000 V AC. **Increases your safety:** Wiha slimBits ensure good, protected access to deep-set screws.

0,8-5,0 Nm PlusMinus/Pozidriv variably adjustable torque limit 5-pcs.

XX2872S3

Order-No.	Icon	Quantity
38074		1
		1 x Torque screwdriver TorqueVario®-S electric variably adjustable torque limit
		1 x Setting tool for torque screwdriver with long handle
		1 x Adapter TorqueVario-S electric for slimBits
		1 x SL/PZ1 / 1 x SL/PZ2

DIN EN ISO 6789.  
Manufactured acc. to IEC 60900.

Torque screwdriver TorqueVario®-S electric



**Meets your requirements:** Variably adjustable torque covers a wide range of applications. **Increases your efficiency:** The correct torque protects material from damage and means no follow-up work. **Protects your health:** With the patented SoftFinish® handle design, ensuring work is kind to hands and muscles. Recommended by doctors and therapists at German Campaign for Healthier Backs. **Lowers your costs:** The correct torque protects you from warranty claims. **Offers you full protection:** Each tool individually tested at 10,000 V AC and approved for 1,000 V AC.

variably adjustable torque limit

2872

Order-No.	Nm	±%				
26625	0.5 - 2	6 %	3.8	131	30	1
26626	0.8 - 5	6 %	3.8	138	36	1
26627	2 - 7	6 %	3.8	142	41	1

Manufactured acc. to IEC 60900. DIN EN ISO 6789.

Setting tool



for torque screwdriver with long handle

2859

Order-No.			
26864	90	146	1

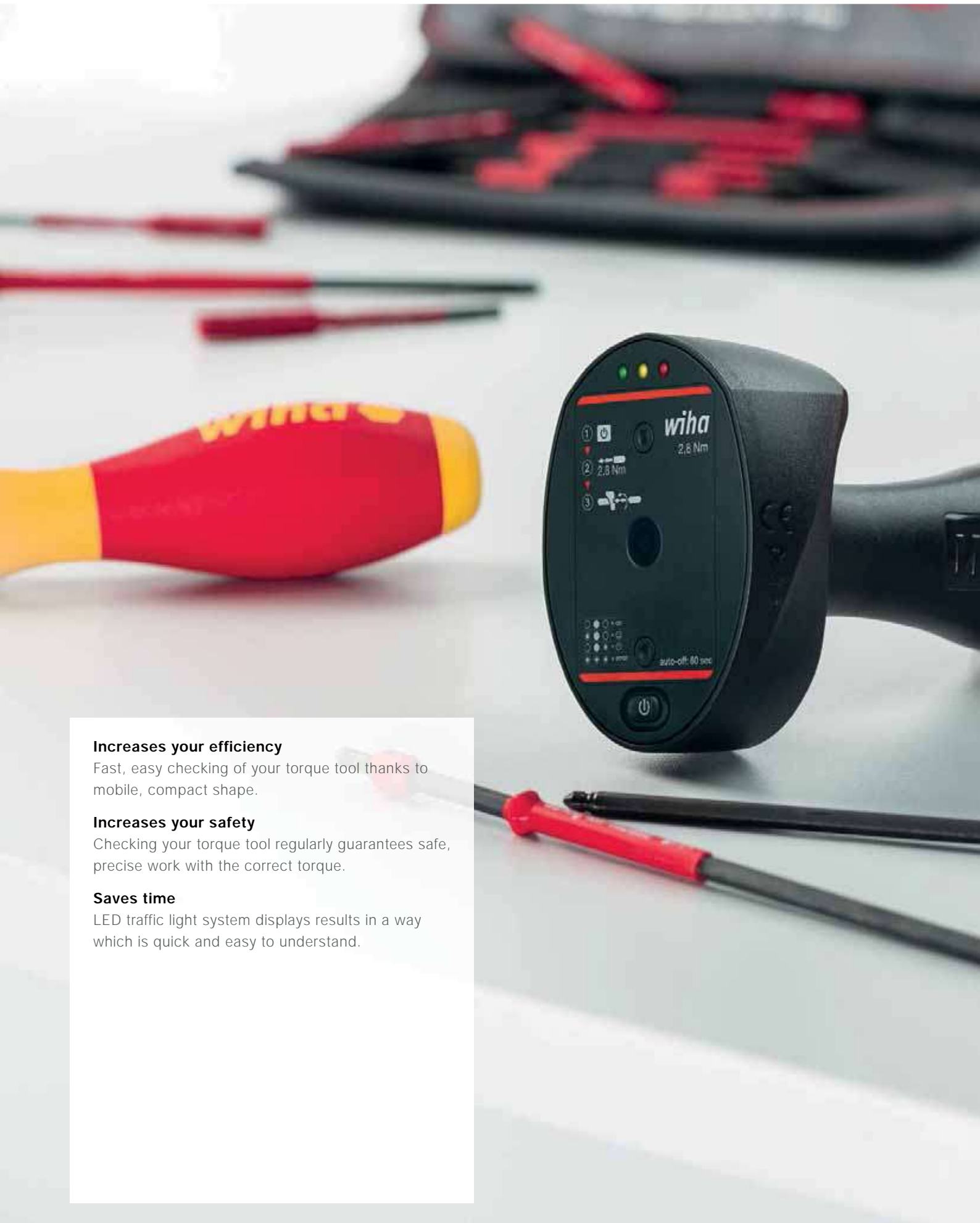

**Increases your efficiency**

Fast, easy checking of your torque tool thanks to mobile, compact shape.

**Increases your safety**

Checking your torque tool regularly guarantees safe, precise work with the correct torque.

**Saves time**

LED traffic light system displays results in a way which is quick and easy to understand.



Torque QuickCheck torque testing device set



Fastening / Jamming

**Increases your efficiency:** Fast, easy checking of your torque tool thanks to mobile, compact shape. **Increases your safety:** Checking your torque tool regularly guarantees safe, precise work with the correct torque. **Saves time:** LED traffic light system displays results in a way which is quick and easy to understand.



4 pcs. with adapter blades, batteries, and box

2909

Order-No.	Nr	VA %	SB	
42086	2.8	2	x	1



INFOBOX:  
Torque QuickCheck



Wiha Torque QuickCheck

- The Wiha torque screwdriver can quickly and easily test torque screwdrivers to check the precision of the configured torque value before each use.
- Checking tools regularly ensures reliable, precise work.
- The device offers user-friendly operation, clear test readings and easy to understand LED traffic light signals.
- Thanks to a compact, handy shape, it is the ideal companion when out on jobs.
- Suitable for all Torque Vario®-S and iTorque® torque screwdrivers whose torque range included 2.8 Nm.

Torque set easyTorque adapter electric



**Increases your efficiency:** The correct torque protects material from damage and means no follow-up work. **Lowers your costs:** The correct torque protects you from warranty claims. **Offers you full protection:** Each tool individually tested at 10,000 V AC and approved for 1,000 V AC.

**0,8 Nm with slimVario® holder and SL/PZ slimBits, 4-pcs.** 29701080S4

Order-No.		
41476	x	5
	1 x 0.8 Nm	
	1 x SL/PZ1 / 1 x SL/PZ2	
	1 x Screwdriver with bit holder SoftFinish® slimVario® electric	

Manufactured acc. to IEC 60900.

**2,0 Nm with slimVario® holder and SL/PZ slimBits, 4-pcs.** 29701200S4

Order-No.		
41477	x	5
	1 x 2.0 Nm	
	1 x SL/PZ1 / 1 x SL/PZ2	
	1 x Screwdriver with bit holder SoftFinish® slimVario® electric	

Manufactured acc. to IEC 60900.

**2,8 Nm with slimVario® holder and SL/PZ slimBits, 4-pcs.** 29701280S4

Order-No.		
41478	x	5
	1 x 2.8 Nm	
	1 x SL/PZ1 / 1 x SL/PZ2	
	1 x Screwdriver with bit holder SoftFinish® slimVario® electric	

Manufactured acc. to IEC 60900.

Torque set easyTorque adapter electric



**Increases your efficiency:** The correct torque protects material from damage and means no follow-up work. **Increases your efficiency:** Fully compatible with the Wiha slimBit system. **Lowers your costs:** The correct torque protects you from warranty claims. **Offers you full protection:** Each tool individually tested at 10,000 V AC and approved for 1,000 V AC. **Lowers your costs:** Torque tool extension for LiftUp and slimVario® screwdriver sets.

**for slimBits and slimVario® holder, 5-pcs.** 29701S5

Order-No.		
41479	x	5
	1 x 0.8 Nm / 1 x 2.0 Nm	
	1 x 2.5 Nm / 1 x 2.8 Nm / 1 x 4.0 Nm	

Manufactured acc. to IEC 60900.

Torque adapter easyTorque electric



**Increases your efficiency:** Fully compatible with the Wiha slimBit system. **Increases your efficiency:** The correct torque protects material from damage and means no follow-up work. **Lowers your costs:** The correct torque protects you from warranty claims. **Lowers your costs:** Torque tool extension for LiftUp and slimVario® screwdriver sets. **Offers you full protection:** Each tool individually tested at 10,000 V AC and approved for 1,000 V AC.

**for slimBits and slimVario® holder in blister** 2970

Order-No.	Nm	±%	mm	mm	
41341	0.8	10 %	59	5.5	5
41342	2.0	10 %	59	5.5	5
41343	2.5	10 %	59	5.5	5
41344	2.8	10 %	59	5.5	5
41345	4.0	10 %	59	5.5	5

Manufactured acc. to IEC 60900.



## slimBit electric bit set



**Makes handling easier:** Convenient safe storage of 12 slimBits – easily taken directly from the belt. **Makes handling easier:** Compact slimBit box with easy access and an optimal view of profiles. **Offers you full protection:** Each tool individually tested at 10,000 V AC and approved for 1,000 V AC. **Increases your safety:** Wiha slimBits ensure good, protected access to deep-set screws.

**TORX®, TORX PLUS®, 15-pcs. Incl. slimBit boxes and belt holder**

SB2831B950

Order-No.



43161

1

- 1 x T6 / 1 x T7 / 1 x T8 / 1 x T9 / 1 x T10 / 1 x T15
- 1 x 6IP / 1 x 7IP / 1 x 8IP / 1 x 9IP / 1 x 10IP / 1 x 15IP
- 2 x slimBit box
- 1 x Belt holster for slimBit box

Tested according to IEC 60900.

**Slotted, Phillips, Pozidriv, PlusMinus/Pozidriv, TORX® 15-pcs. Incl. slimBit boxes and belt holder**

SB2831B951

Order-No.



43162

1

- 1 x 3.5 mm / 1 x 5.5 mm
- 1 x PH1 / 1 x PH2
- 1 x PZ1 / 1 x PZ2
- 1 x SL/PZ1 / 1 x SL/PZ2
- 1 x T10 / 1 x T15 / 1 x T20 / 1 x T25
- 2 x slimBit box
- 1 x Belt holster for slimBit box

Tested according to IEC 60900.

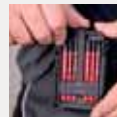
**INFOBOX:  
slimBit box**

**slimBit box**

- Compact slimBit box with easy access and an optimal view of profiles.
- Suitable for storing Wiha slimBits. Ideal for mobile use.
- Wiha slimBits ensure unrestricted and fully insulated access to low-lying screws.
- Each tool individually tested at 10,000 V AC and approved for 1,000 V AC.

## slimBit electric bit set



**Makes handling easier:** Compact slimBit box with easy access and an optimal view of profiles. **Offers you full protection:** Each tool individually tested at 10,000 V AC and approved for 1,000 V AC. **Increases your safety:** Wiha slimBits ensure good, protected access to deep-set screws.

**Slotted, 7-pcs. incl. SlimBit box**

SB2831B001

Order-No.



43152

1

➔ 1 x 2.0 mm / 1 x 2.5 mm / 1 x 3.5 mm / 1 x 4.0 mm / 1 x 5.5 mm / 1 x 6.5 mm  
1 x slimBit box

Tested according to IEC 60900.

**TORX®, 7-pcs. incl. SlimBit box**

SB2831B501

Order-No.



43153

1

⚙ 1 x T8 / 1 x T9 / 1 x T10 / 1 x T15 / 1 x T20 / 1 x T25  
1 x slimBit box

Tested according to IEC 60900.

**TORX®, 7-pcs. incl. SlimBit box**

SB2831B502

Order-No.



43154

1

⚙ 1 x T6 / 1 x T7 / 1 x T8 / 1 x T9 / 1 x T10 / 1 x T15  
1 x slimBit box

Tested according to IEC 60900.

**TORX PLUS®, 7-pcs. incl. SlimBit box**

SB2831B601

Order-No.



43155

1

⚙ 1 x 6IP / 1 x 7IP / 1 x 8IP / 1 x 9IP / 1 x 10IP / 1 x 15IP  
1 x slimBit box

Tested according to IEC 60900.

**Hex, 7-pcs. incl. SlimBit box**

SB2831B801

Order-No.



43156

1

⚙ 1 x 2.0 mm / 1 x 2.5 mm / 1 x 3.0 mm / 1 x 4.0 mm / 1 x 5.0 mm / 1 x 6.0 mm  
1 x slimBit box

Tested according to IEC 60900.

**Slotted, Pozidriv 7-pcs. incl. SlimBit box**

SB2831B900

Order-No.



43157

1

➔ 1 x 2.5 mm / 1 x 3.5 mm / 1 x 5.5 mm / 1 x 6.5 mm  
⚙ 1 x PZ1 / 1 x PZ2  
1 x slimBit box

Tested according to IEC 60900.

**Slotted, PlusMinus/Pozidriv 7-pcs. incl. SlimBit box**

SB2831B901

Order-No.



43158

1

➔ 1 x 2.5 mm / 1 x 3.5 mm / 1 x 5.5 mm / 1 x 6.5 mm  
⚙ 1 x SL/PZ1 / 1 x SL/PZ2  
1 x slimBit box

Tested according to IEC 60900.

**Slotted, Phillips 7-pcs. incl. SlimBit box**

SB2831B902

Order-No.



43159

1

➔ 1 x 2.5 mm / 1 x 3.5 mm / 1 x 5.5 mm / 1 x 6.5 mm  
⚙ 1 x PH1 / 1 x PH2  
1 x slimBit box

Tested according to IEC 60900.

**Slotted, Phillips, Pozidriv 7-pcs. incl. SlimBit box**

SB2831B903

Order-No.



43160

1

➔ 1 x 2.0 mm / 1 x 2.5 mm  
⚙ 1 x PH0 / 1 x PH1  
⚙ 1 x PZ0 / 1 x PZ1  
1 x slimBit box

Tested according to IEC 60900.

**Mixed 7-pcs. incl. slimBit box**

SB2831B904

Order-No.



44366

1

➔ 1 x 2.5 mm  
⚙ 1 x PH1  
⚙ 1 x PZ1  
⚙ 1 x SL/PZ1  
⚙ 1 x T9 / 1 x T10  
1 x slimBit box

Tested according to IEC 60900.



Power slimBit electric bit set



**Increases your safety:** Wiha Power slimBits ensure good, protected access to deep-set screws. **Makes handling easier:** Compact slimBit box with easy access and an optimal view of profiles. **Offers you full protection:** Each tool individually tested at 10,000 V AC and approved for 1,000 V AC.

slimBit box



**Makes handling easier:** Compact slimBit box with easy access and an optimal view of profiles. **Makes handling easier:** Convenient safe storage of 12 slimBits – easily taken directly from the belt.

Mixed 7-pcs. incl. slimBit box

SB2831PB900

Order-No.	
44106	1
	1 x Bit Power slimBit electric - Slotted 5.5
	1 x Bit Power slimBit electric - PH2
	1 x Bit Power slimBit electric - SL/PZ2
	1 x Bit Power slimBit electric - T15 / 1 x Bit Power slimBit electric - T20 / 1 x Bit Power slimBit electric - T25
	1 x slimBit box

Tested according to IEC 60900.

Slotted, hex, 7-pcs. incl. slimBit box

SB2831PB901

Order-No.	
44107	1
	1 x Bit Power slimBit electric - Slotted 6.5
	1 x Bit Power slimBit electric - Innensechskant 2.5 / 1 x Bit Power slimBit electric - Innensechskant 3 / 1 x Bit Power slimBit electric - Innensechskant 4 / 1 x Bit Power slimBit electric - Innensechskant 5 / 1 x Bit Power slimBit electric - Innensechskant 6
	1 x slimBit box

Tested according to IEC 60900.

empty, 2-pcs. with belt clip

SB2831B992

Order-No.	
43164	1
	2 x slimBit box
	1 x Belt holster for slimBit box

slimBit box



**Makes handling easier:** Compact slimBit box with easy access and an optimal view of profiles.

empty

SB2831B991

Order-No.	
43163	1
	1 x slimBit box, empty

slimBit electric bit



**Increases your safety:** Wiha slimBits ensure good, protected access to deep-set screws. **Saves space:** Extensive interchangeable bit system saves you space. **Offers you full protection:** Each tool individually tested at 10,000 V AC and approved for 1,000 V AC.

**Slotted** 283110

Order-No.		mm		max Nm	
43114	1.5•	75	0.4	0.2	5
43115	2.0•	75	0.4	0.4	5
34578	2.5•	75	0.4	0.4	5
34579	3.0•	75	0.5	0.6	5
41159	3.5	75	0.6	1.4	5
34580	4.0	75	0.8	2.5	5
34581	5.5	75	1.0	3.8	5
34582	6.5	75	1.2	5.5	5

•no slim version  
Manufactured acc. to IEC 60900.

**Slotted with pivot** 283110

Order-No.		mm		max Nm	
44385	3.5	75	0.6	1.4	5

**Phillips** 283111

Order-No.		mm	max Nm	
43116	PH0•	75	0.9	5
34583	PH1	75	3.8	5
34584	PH2	75	5.5	5

•no slim version  
Manufactured acc. to IEC 60900.

**Pozidriv** 283112

Order-No.		mm	max Nm	
43117	PZ0•	75	0.9	5
34585	PZ1	75	3.8	5
34586	PZ2	75	5.5	5

•no slim version  
Manufactured acc. to IEC 60900.

**PlusMinus/Phillips** 283113

Order-No.		mm	max Nm	
34587	SL/PH1	75	3.8	5
34588	SL/PH2	75	5.5	5

Manufactured acc. to IEC 60900.

**PlusMinus/Pozidriv** 283114

Order-No.		mm	max Nm	
34589	SL/PZ1	75	3.8	5
34590	SL/PZ2	75	5.5	5

Manufactured acc. to IEC 60900.

**TORX®** 283115

Order-No.		mm	max Nm	
43140	T5•	75	0.4	5
43141	T6•	75	0.6	5
43142	T7•	75	0.9	5
35506	T8•	75	1.3	5
41160	T9•	75	2.5	5
35507	T10•	75	3.8	5
35508	T15	75	5.0	5
35509	T20	75	5.5	5
36071	T25	75	5.5	5

•no slim version  
Manufactured acc. to IEC 60900.

**TORX PLUS®** 283116

Order-No.		mm	max Nm	
43143	5IP•	75	0.5	5
43144	6IP•	75	0.8	5
43145	7IP•	75	1.3	5
43146	8IP•	75	2.0	5
43147	9IP•	75	3.0	5
43148	10IP•	75	4.5	5
43149	15IP	75	5.5	5
43150	20IP	75	5.5	5
43151	25IP	75	5.5	5

•no slim version  
Manufactured acc. to IEC 60900.

**Hex** 283118

Order-No.		mm	max Nm	
37222	1.5•	75	0.9	5
37223	2.0•	75	1.8	5
37224	2.5	75	3.8	5
37147	3.0	75	5.5	5
37225	4.0	75	5.5	5
37226	5.0	75	5.5	5
37227	6.0	75	5.5	5

•no slim version  
Manufactured acc. to IEC 60900.

**Internal square** 283117

Order-No.		mm	max Nm		
35510	#1	2.3	75	5.5	5
35511	#2	2.8	75	5.5	5

Manufactured acc. to IEC 60900.

Adapter TorqueVario-S electric



**Increases your efficiency:** Fully compatible with the Wiha slimBit system. **Increases your efficiency:** Solve every fastening task with the Wiha slimBit range. **Offers you full protection:** Each tool individually tested at 10,000 V AC and approved for 1,000 V AC.

for slimBits

28799

Order-No.					
35870	6.0	3.8	170	13	10

Manufactured acc. to IEC 60900.

Insulated nut driver insert



**Offers you full protection:** Each tool individually tested at 10,000 V AC and approved for 1,000 V AC. **Protects your material:** Fully insulated tool reduces the risk of short circuits.

1/4" hexagon head

7209NS

Order-No.			
43088	4.0	42	1
43089	5.0	42	1
43090	5.5	42	1
43091	6.0	42	1
43092	7.0	42	1
43093	8.0	42	1
43094	9.0	42	1
43095	10.0	42	1
43096	11.0	42	1
43097	12.0	42	1
43098	13.0	42	1
43099	14.0	42	1

Adapter TorqueVario-S electric



**Increases your efficiency:** Adapter allows users to fasten with a nut driver and TorqueVario®-S electric. **Offers you full protection:** Each tool individually tested at 10,000 V AC and approved for 1,000 V AC.

for 1/4" nut driver

28799

Order-No.					
43128	1/4"	3.8	178	12	10

Manufactured acc. to IEC 60900.

Torque screwdriver with T-handle TorqueVario®-S T electric



**Meets your requirements:** Variably adjustable torque covers a wide range of applications. **Increases your efficiency:** The correct torque protects material from damage and means no follow-up work. **Makes handling easier:** Effortless and comfortable transmission of high torques thanks to T-handle with ComfortGrip. **Lowers your costs:** The correct torque protects you from warranty claims. **Offers you full protection:** Torque blades tested at 10,000 V AC and approved for 1,000 V AC.

5-14 Nm variably adjustable torque limit 2933

Order-No.	Nm	±%	mm	mm	mm	mm
43177	5 - 14	6 %	6.0	56	120	1

Interchangeable electric blade



**Increases your efficiency:** Extensive interchangeable blade system saves you space. **Offers you full protection:** Each tool individually tested at 10,000 V AC and approved for 1,000 V AC. **Increases your safety:** Wiha slim interchangeable blades ensure unlimited and fully-insulated access to low-lying screws.

TORX® for torque screwdriver with T-handle electric 283795

Order-No.	mm	mm	mm	mm
38931	T15	136	35	5.5
38932	T20	136	35	10.0
38933	T25	136	35	15.0
38934	T27	136	35	15.0
38935	T30	136	35	20.0
38936	T40	136	35	20.0

Manufactured acc. to IEC 60900.

Hex for torque screwdriver with T-handle electric 283793

Order-No.	mm	mm	mm	mm
38918	3.0	136	35	5.5
38919	4.0	136	35	15.0
38920	5.0	136	35	20.0
38921	6.0	136	35	20.0

Manufactured acc. to IEC 60900.

INFOBOX:  
Torque T-handle  
TorqueVario®-S T  
electric



Torque T-handle TorqueVario®-S T electric

- For controlled fastening in a large range of applications.
- Torque value is continuously adjustable thanks to the adjusting tool.
- More fastening power thanks to T-handle design.
- Each tool individually tested at 10,000 V AC and approved for 1,000 V AC.
- Certified individual item testing directly after on-site production.

Interchangeable electric blade



**Increases your efficiency:** Extensive interchangeable blade system saves you space. **Offers you full protection:** Each tool individually tested at 10,000 V AC and approved for 1,000 V AC.

Hex nut driver for torque screwdriver with T-handle electric 283794

Order-No.	mm	mm	mm	mm
38925	7.0	136	5.0	10
38926	8.0	136	10.0	10
38927	9.0	136	14.0	10
38928	10.0	136	17.0	10
38929	13.0	136	20.0	10
38930	17.0	136	20.0	10

Manufactured acc. to IEC 60900.

Setting tool



for torque screwdriver with T-handle

2899

Order-No.			
28691	90	146	10

All bits in the handle, always and everywhere.



Why make things complicated, when they can be compact? The practical Wiha LiftUp electric magazine bit holder accommodates up to six common insulated slimBits - and is therefore the ideal portable companion for every electrician. The bit magazine is unlocked at the touch of a button on the two rockers, and the slimBits can easily be removed and re-inserted. A reliably locked magazine prevents anything from being lost when on the move. The rotating cap is used to make working easier: Additional axial force can be exerted by pressing strongly with the hand against the cap, while rotating around the longitudinal axis with the other hand. Uncompromising safety is ensured in production and testing according to IEC 60900, VDE/GS certification and individual part testing at 10,000 V AC. The Wiha magazine bit holder LiftUp electric is available in three content variants (SL/PH or SL/PH/PlusMinus PZ).

- **Increases your efficiency**

Wiha LiftUp electric, saves 75 % volume and 50 % less weight for 100 % efficiency.

- **Protect your health**

No risk of injury, all blades stowed safely inside the handle.

- **Offers you full protection**

Each tool individually tested at 10,000 V AC and approved for 1,000 V AC.

- **Increases your safety**

Wiha slimBits grant unhindered, fully insulated access to deep lying screws.



## Screwdriver with bit magazine LiftUp electric



**Increases your efficiency:** Wiha LiftUp electric saves 75% volume and 50% less weight for 100 % efficiency. **Protects your health:** No risk of injury, all blades stowed safely inside the handle. **Offers you full protection:** Each tool individually tested at 10,000 V AC and approved for 1,000 V AC. **Increases your safety:** Wiha slimBits ensure good, protected access to deep-set screws.

## sSlotted, Phillips with 6 slimBits pack

SB283109020

Order-No.		
38612	x	5
	1 x 2.5 mm / 1 x 3.0 mm / 1 x 4.0 mm / 1 x 5.5 mm	
	1 x PH1 / 1 x PH2	

Manufactured acc. to IEC 60900.

## Phillips, PlusMinus/Pozidriv, slotted with 6 slimBits in blister pack

SB283109021

Order-No.		
38613	x	5
	1 x 3.0 mm / 1 x 4.0 mm / 1 x 5.5 mm	
	1 x PH1 / 1 x PH2	
	1 x SL/PZ2	

Manufactured acc. to IEC 60900.

## TORX® with 6 slimBits

SB283109022

Order-No.		
41158	x	5
	1 x T8 / 1 x T9 / 1 x T10 / 1 x T15 / 1 x T20 / 1 x T25	

Manufactured acc. to IEC 60900.

## Slotted, Pozidriv, PlusMinus/Pozidriv with 6 slimBits

SB283109023

Order-No.		
41235	x	5
	1 x 2.5 mm / 1 x 3.5 mm / 1 x 5.5 mm	
	1 x PZ1 / 1 x PZ2	
	1 x SL/PZ2	

Manufactured acc. to IEC 60900.



Screwdriver with bit magazine PocketMax® electric



**Increases your efficiency:** Your daily companion – always have the relevant profiles with you. **Saves space:** Compact and light tool, fits into any pants pockets. **Protects your health:** No risk of injury, \*all bits stowed safely inside the handle. **Increases your safety:** Wiha slimBits ensure good, protected access to deep-set screws. **Offers you full protection:** Each tool individually tested at 10,000 V AC and approved for 1,000 V AC.

**mixed with 4 slimBits**

SB283109040

Order-No.		
45296	x	1
	3.5 mm	
	PH1 x 75 mm / PH2 x 75 mm	
	SL/PZ2	

Tested according to IEC 60900.



## Screwdriver and bit set slimVario® screwdriver



**Simplifies your work:** All tools securely arranged in a robust, orderly bag. **Increases your efficiency:** Extensive interchangeable blade system saves you space. **Offers you full protection:** Each tool individually tested at 10,000 V AC and approved for 1,000 V AC. **Increases your safety:** Wiha slimBits ensure good, protected access to deep-set screws.

## Mixed, 19-pcs. incl. folding bag

2831T18

Order-No.



41231

1

- 1 x Screwdriver with bit holder SoftFinish® electric slimVario
- 1 x Screwdriver with bit holder SoftFinish® electric slimVario for slimBits
- ↵ 1 x 2.5 mm / 1 x 3.5 mm / 1 x 5.5 mm
- ⊕ 1 x PH1 / 1 x PH2
- ⊕ 1 x PZ1 / 1 x PZ2
- ⊕ 1 x SL/PZ1 / 1 x SL/PZ2
- ⊕ 1 x T9 / 1 x T10 / 1 x T15 / 1 x T20
- 1 x 3.0 mm / 1 x 4.0 mm / 1 x 5.0 mm
- 1 x Folding bag

Manufactured acc. to IEC 60900.



## Screwdriver and bit set slimVario® screwdriver



**Simplifies your work:** All tools securely arranged in a robust, orderly bag. **Increases your efficiency:** Extensive interchangeable blade system saves you space. **Offers you full protection:** Each tool individually tested at 10,000 V AC and approved for 1,000 V AC. **Increases your safety:** Wiha slimBits ensure good, protected access to deep-set screws.

## Slotted, Phillips, Pozidriv, 10-pcs. incl. folding bag

2831T901

Order-No.		
41232		1
	1 x Screwdriver with bit holder SoftFinish® electric slimVario	
	1 x Screwdriver with bit holder SoftFinish® electric slimVario for slimBits	
	1 x 2.5 mm / 1 x 3.5 mm / 1 x 5.5 mm	
	1 x PH1 / 1 x PH2	
	1 x PZ1 / 1 x PZ2	
	1 x Folding bag	

Manufactured acc. to IEC 60900.

## Slotted, Pozidriv, PlusMinus/Pozidriv, 10-pcs. incl. folding bag

2831T902

Order-No.		
41233		1
	1 x Screwdriver with bit holder SoftFinish® electric slimVario	
	1 x Screwdriver with bit holder SoftFinish® electric slimVario for slimBits	
	1 x 2.5 mm / 1 x 3.5 mm / 1 x 5.5 mm	
	1 x PZ1 / 1 x PZ2	
	1 x SL/PZ1 / 1 x SL/PZ2	
	1 x Folding bag	

Manufactured acc. to IEC 60900.



## Screwdriver and nut driver insert 1/4" set slimVario® electric

1000 V  
IEC 60900

**Simplifies your work:** All tools securely arranged in a robust, orderly bag. **Protects your material:** Fully insulated nut driver reduces the risk of short circuits. **Offers you full protection:** Each tool individually tested at 10,000 V AC and approved for 1,000 V AC. **Increases your safety:** Wiha slimBits ensure good, protected access to deep-set screws.

**mixed, 14-pcs. incl. folding bag**

7209NK2004

Order-No.



43467

1

- 1 x SoftFinish® electric screwdriver handle
- 1 x Extension slimVario® electric for slimBits
- 1 x slimVario® electric adapter for 1/4" nut driver
- 1 x 3.5 mm / 1 x 5.5 mm
- 1 x 5.0 mm / 1 x 5.5 mm / 1 x 6.0 mm / 1 x 7.0 mm / 1 x 8.0 mm / 1 x 10.0 mm / 1 x 11.0 mm / 1 x 13.0 mm
- 1 x Folding bag

Manufactured acc. to IEC 60900.

Screwdriver with bit holder set electric slimVar-  
io®



**Simplifies your work:** Compact handle – maximum power. **Increases your efficiency:** Fully compatible with the Wiha slimBit system. **Offers you full protection:** Each tool individually tested at 10,000 V AC and approved for 1,000 V AC. **Increases your safety:** Wiha slimBits ensure good, protected access to deep-set screws. **Increases your safety:** Protected work in constricted spaces.

**Stubby 4 pieces with slimBits**

SB28310101

Order-No.	
41230	5
	Screwdriver with bit holder SoftFinish® electric slimVario
	3.5 mm
	PH2
	SL/PZ2

Manufactured acc. to IEC 60900.

Screwdriver with bit holder set SoftFinish® slim-  
Vario® electric



**Protects your health:** With the patented SoftFinish® handle design, ensuring work is kind to hands and muscles. Recommended by doctors and therapists at German Campaign for Healthier Backs. **Offers you full protection:** Each tool individually tested at 10,000 V AC and approved for 1,000 V AC. **Increases your safety:** Wiha slimBits ensure good, protected access to deep-set screws.

**4-pcs. with slimBits**

SB28310301

Order-No.	
43449	5
	Screwdriver with bit holder SoftFinish® electric slimVario for slimBits
	5.5 mm
	SL/PZ1 x 75 mm / SL/PZ2 x 75 mm

Manufactured acc. to IEC 60900.

Fine screwdriver set PicoFinish® slimVario®  
electric



**Increases your efficiency:** Fully compatible with the Wiha slimBit system. **Increases your efficiency:** Careful workmanship and controlled power transmission thanks to the slim handle with soft grip. **Increases your efficiency:** Particularly suitable for use with slimBit profiles. **Offers you full protection:** Each tool individually tested at 10,000 V AC and approved for 1,000 V AC. **Increases your safety:** Wiha slimBits ensure good, protected access to deep-set screws.

**4-pcs. with slimBits**

SB28310401

Order-No.	
43167	5
	Fine screwdriver PicoFinish® slimVario® electric
	2.0 mm
	PH0
	PZ0

INFOBOX:  
slimTECHNOLOGY



**Wiha SoftFinish® electric slimFix**

- Unlimited access.
- Blades up to 33 % narrower due to integrated insulation.
- Tool for spring clips (wedge-profiled output geometry).





**Makes handling easier:** Convenient safe storage of 12 slimBits – easily taken directly from the belt. **Makes handling easier:** Compact slimBit box with easy access and an optimal view of profiles. **Offers you full protection:** Each tool individually tested at 10,000 V AC and approved for 1,000 V AC. **Increases your safety:** Wiha slimBits ensure good, protected access to deep-set screws.

**TORX®, TORX PLUS®, 15-pcs. Incl. slimBit boxes and belt holder**

SB2831B950

Order-No.



43161

1

- 1 x 6IP / 1 x 7IP / 1 x 8IP / 1 x 9IP / 1 x 10IP / 1 x 15IP
- 1 x T6 / 1 x T7 / 1 x T8 / 1 x T9 / 1 x T10 / 1 x T15
- 2 x slimBit box
- 1 x Belt holster for slimBit box

Tested according to IEC 60900.

**TORX®, TORX PLUS®, 15-pcs. Incl. slimBit boxes and belt holder**

SB2831B950

Order-No.



43161

1

- 1 x 6IP / 1 x 7IP / 1 x 8IP / 1 x 9IP / 1 x 10IP / 1 x 15IP
- 1 x T6 / 1 x T7 / 1 x T8 / 1 x T9 / 1 x T10 / 1 x T15
- 2 x slimBit box
- 1 x Belt holster for slimBit box

Tested according to IEC 60900.

**Slotted, Phillips, Pozidriv, PlusMinus/Pozidriv, TORX® 15-pcs. Incl. slimBit boxes and belt holder**

SB2831B951

Order-No.



43162

1

- 1 x 3.5 mm / 1 x 5.5 mm
- 1 x PH1 / 1 x PH2
- 1 x PZ1 / 1 x PZ2
- 1 x SL/PZ1 / 1 x SL/PZ2
- 1 x T10 / 1 x T15 / 1 x T20 / 1 x T25
- 2 x slimBit box
- 1 x Belt holster for slimBit box

Tested according to IEC 60900.

**Slotted, Phillips, Pozidriv, PlusMinus/Pozidriv, TORX® 15-pcs. Incl. slimBit boxes and belt holder**

SB2831B951

Order-No.



43162

1

- 1 x 3.5 mm / 1 x 5.5 mm
- 1 x PH1 / 1 x PH2
- 1 x PZ1 / 1 x PZ2
- 1 x SL/PZ1 / 1 x SL/PZ2
- 1 x T10 / 1 x T15 / 1 x T20 / 1 x T25
- 2 x slimBit box
- 1 x Belt holster for slimBit box

Tested according to IEC 60900.

## slimBit electric bit set



**Makes handling easier:** Compact slimBit box with easy access and an optimal view of profiles. **Offers you full protection:** Each tool individually tested at 10,000 V AC and approved for 1,000 V AC. **Increases your safety:** Wiha slimBits ensure good, protected access to deep-set screws.

**Slotted, 7-pcs. incl. SlimBit box**

SB2831B001

Order-No.



43152

1

➔ 1 x 2.0 mm / 1 x 2.5 mm / 1 x 3.5 mm / 1 x 4.0 mm / 1 x 5.5 mm / 1 x 6.5 mm  
1 x slimBit box

Tested according to IEC 60900.

**TORX®, 7-pcs. incl. SlimBit box**

SB2831B501

Order-No.



43153

1

⚙ 1 x T8 / 1 x T9 / 1 x T10 / 1 x T15 / 1 x T20 / 1 x T25  
1 x slimBit box

Tested according to IEC 60900.

**TORX®, 7-pcs. incl. SlimBit box**

SB2831B502

Order-No.



43154

1

⚙ 1 x T6 / 1 x T7 / 1 x T8 / 1 x T9 / 1 x T10 / 1 x T15  
1 x slimBit box

Tested according to IEC 60900.

**TORX PLUS®, 7-pcs. incl. SlimBit box**

SB2831B601

Order-No.



43155

1

⚙ 1 x 6IP / 1 x 7IP / 1 x 8IP / 1 x 9IP / 1 x 10IP / 1 x 15IP  
1 x slimBit box

Tested according to IEC 60900.

**Hex, 7-pcs. incl. SlimBit box**

SB2831B801

Order-No.



43156

1

⚙ 1 x 2.0 mm / 1 x 2.5 mm / 1 x 3.0 mm / 1 x 4.0 mm / 1 x 5.0 mm / 1 x 6.0 mm  
1 x slimBit box

Tested according to IEC 60900.

**Slotted, Pozidriv 7-pcs. incl. SlimBit box**

SB2831B900

Order-No.



43157

1

➔ 1 x 2.5 mm / 1 x 3.5 mm / 1 x 5.5 mm / 1 x 6.5 mm  
⚙ 1 x PZ1 / 1 x PZ2  
1 x slimBit box

Tested according to IEC 60900.

**Slotted, PlusMinus/Pozidriv 7-pcs. incl. SlimBit box**

SB2831B901

Order-No.



43158

1

➔ 1 x 2.5 mm / 1 x 3.5 mm / 1 x 5.5 mm / 1 x 6.5 mm  
⚙ 1 x SL/PZ1 / 1 x SL/PZ2  
1 x slimBit box

Tested according to IEC 60900.

**Slotted, Phillips 7-pcs. incl. SlimBit box**

SB2831B902

Order-No.



43159

1

➔ 1 x 2.5 mm / 1 x 3.5 mm / 1 x 5.5 mm / 1 x 6.5 mm  
⚙ 1 x PH1 / 1 x PH2  
1 x slimBit box

Tested according to IEC 60900.

**Slotted, Phillips, Pozidriv 7-pcs. incl. SlimBit box**

SB2831B903

Order-No.



43160

1

➔ 1 x 2.0 mm / 1 x 2.5 mm  
⚙ 1 x PH0 / 1 x PH1  
⚙ 1 x PZ0 / 1 x PZ1  
1 x slimBit box

Tested according to IEC 60900.

**Mixed 7-pcs. incl. slimBit box**

SB2831B904

Order-No.



44366

1

➔ 1 x 2.5 mm  
⚙ 1 x PH1  
⚙ 1 x PZ1  
⚙ 1 x SL/PZ1  
⚙ 1 x T9 / 1 x T10  
1 x slimBit box

Tested according to IEC 60900.



Power slimBit electric bit set







**Increases your safety:** Wiha Power slimBits ensure good, protected access to deep-set screws. **Makes handling easier:** Compact slimBit box with easy access and an optimal view of profiles. **Offers you full protection:** Each tool individually tested at 10,000 V AC and approved for 1,000 V AC.

Mixed 7-pcs. incl. slimBit box

SB2831PB900

Order-No.  44106 1

-  1 x Bit Power slimBit electric - Slotted 5.5
-  1 x Bit Power slimBit electric - PH2
-  1 x Bit Power slimBit electric - SL/PZ2
-  1 x Bit Power slimBit electric - T15 / 1 x Bit Power slimBit electric - T20 / 1 x Bit Power slimBit electric - T25
- 1 x slimBit box

Tested according to IEC 60900.

Slotted, hex, 7-pcs. incl. slimBit box

SB2831PB901

Order-No.  44107 1

-  1 x Bit Power slimBit electric - Slotted 6.5
- 1 x Bit Power slimBit electric - Innensechskant 2.5 / 1 x Bit Power slimBit electric - Innensechskant 3 / 1 x Bit Power slimBit electric - Innensechskant 4 / 1 x Bit Power slimBit electric - Innensechskant 5 / 1 x Bit Power slimBit electric - Innensechskant 6
- 1 x slimBit box

Tested according to IEC 60900.

slimBit box



**Makes handling easier:** Compact slimBit box with easy access and an optimal view of profiles. **Makes handling easier:** Convenient safe storage of 12 slimBits – easily taken directly from the belt.

empty, 2-pcs. with belt clip

SB2831B992

Order-No.  43164 1

2 x slimBit box

1 x Belt holster for slimBit box

slimBit box



**Makes handling easier:** Compact slimBit box with easy access and an optimal view of profiles.

empty

SB2831B991

Order-No.  43163 1

1 x slimBit box, empty

slimBit electric bit



**Increases your safety:** Wiha slimBits ensure good, protected access to deep-set screws. **Saves space:** Extensive interchangeable bit system saves you space. **Offers you full protection:** Each tool individually tested at 10,000 V AC and approved for 1,000 V AC.

Slotted

283110

Order-No.			mm	max Nm	
43114	1.5•	0.4	75	0.2	5
43115	2.0•	0.4	75	0.4	5
34578	2.5•	0.4	75	0.4	5
34579	3.0•	0.5	75	0.6	5
41159	3.5	0.6	75	1.4	5
34580	4.0	0.8	75	2.5	5
34581	5.5	1.0	75	3.8	5
34582	6.5	1.2	75	5.5	5
44385	3.5	0.6	75	1.4	5

•no slim version  
Manufactured acc. to IEC 60900.

Phillips

283111

Order-No.		mm	max Nm	
43116	PH0•	75	0.9	5
34583	PH1	75	3.8	5
34584	PH2	75	5.5	5

•no slim version  
Manufactured acc. to IEC 60900.

Pozidriv

283112

Order-No.		mm	max Nm	
43117	PZ0•	75	0.9	5
34585	PZ1	75	3.8	5
34586	PZ2	75	5.5	5

•no slim version  
Manufactured acc. to IEC 60900.

PlusMinus/Phillips

283113

Order-No.		mm	max Nm	
34587	SL/PH1	75	3.8	5
34588	SL/PH2	75	5.5	5

Manufactured acc. to IEC 60900.

PlusMinus/Pozidriv

283114

Order-No.		mm	max Nm	
34589	SL/PZ1	75	3.8	5
34590	SL/PZ2	75	5.5	5

Manufactured acc. to IEC 60900.

TORX®

283115

Order-No.		mm	max Nm	
43140	T5•	75	0.4	5
43141	T6•	75	0.6	5
43142	T7•	75	0.9	5
35506	T8•	75	1.3	5
41160	T9•	75	2.5	5
35507	T10•	75	3.8	5
35508	T15	75	5.0	5
35509	T20	75	5.5	5
36071	T25	75	5.5	5

•no slim version  
Manufactured acc. to IEC 60900.

TORX PLUS®

283116

Order-No.		mm	max Nm	
43143	5IP•	75	0.5	5
43144	6IP•	75	0.8	5
43145	7IP•	75	1.3	5
43146	8IP•	75	2.0	5
43147	9IP•	75	3.0	5
43148	10IP•	75	4.5	5
43149	15IP	75	5.5	5
43150	20IP	75	5.5	5
43151	25IP	75	5.5	5

•no slim version  
Manufactured acc. to IEC 60900.

Hex

283118

Order-No.		mm	max Nm	
37222	1.5•	75	0.9	5
37223	2.0•	75	1.8	5
37224	2.5	75	3.8	5
37147	3.0	75	5.5	5
37225	4.0	75	5.5	5
37226	5.0	75	5.5	5
37227	6.0	75	5.5	5

•no slim version  
Manufactured acc. to IEC 60900.

Internal square

283117

Order-No.			mm	max Nm	
35510	#1	2.3	75	5.5	5
35511	#2	2.8	75	5.5	5

Manufactured acc. to IEC 60900.

Extension slimVario® electric



1000 V  
IEC 60900

**Offers you full protection:** Each tool individually tested at 10,000 V AC and approved for 1,000 V AC. **Improved access:** Deep-set screws can be reached easily.

for slimBits

2831

Order-No.			
43292	6.0	69.5	6

slimVario® electric adapter



1000 V  
IEC 60900

**Increases your efficiency:** Adapter allows nut driver to be fastened with speedE® and slimVario® handles. **Offers you full protection:** Each tool individually tested at 10,000 V AC and approved for 1,000 V AC.

for 1/4" nut driver

2831

Order-No.			
43139	1/4"	59	6

INFOBOX:  
VDE interchangeable bit system

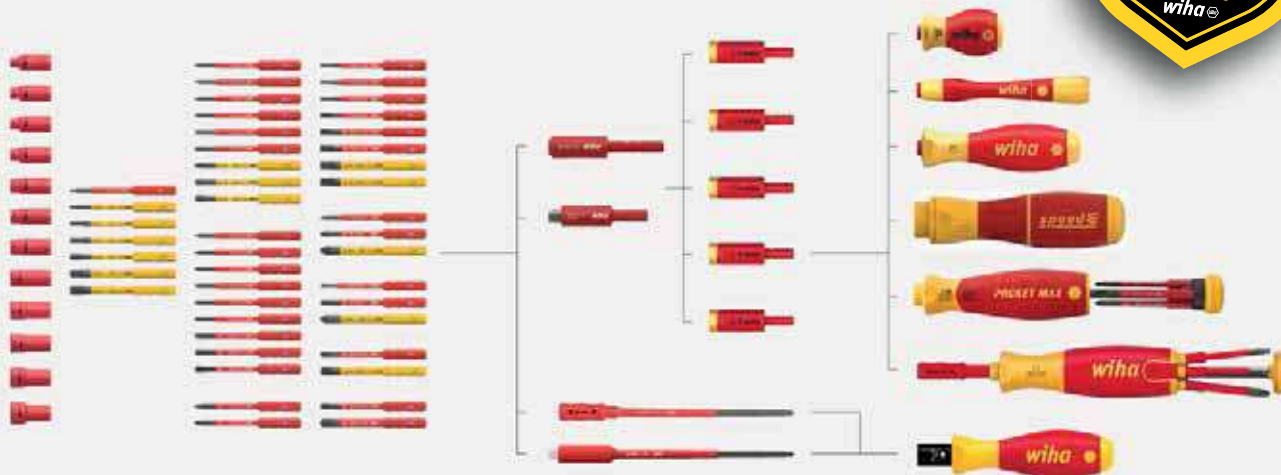

Can be used with these slimBits

- 1,5 / 2,0 / 2,5 / 3,0 / 3,5 / 4,0 / 5,5 / 6,5
- 3,5
- PH0 / PH1 / PH2
- PZ0 / PZ1 / PZ2
- SL/PZ1 / SL/PZ2
- T5 / T6 / T7 / T8 / T9 / T10 / T15 / T20 / T25
- IP5 / IP6 / IP7 / IP8 / IP9 / IP10 / IP15 / IP20 / IP25
- 1,5 / 2 / 2,5 / 3 / 4 / 5 / 6
- Robertson 1 / 2

VDE interchangeable bit system

- Compact VDE bit sets: holder + slimBit (length 75 mm).
- Wiha slimBits ensure good, protected access to deep-set screws.
- slimBits tested at 10,000 V AC and approved for 1,000 V AC.
- Space saved thanks to extensive interchangeable bit system and nut driver inserts.

VDE torque system

- Controlled tightening of electrical screw connections.



Fastening / Jamming

## Screwdriver set SoftFinish® electric slimFix

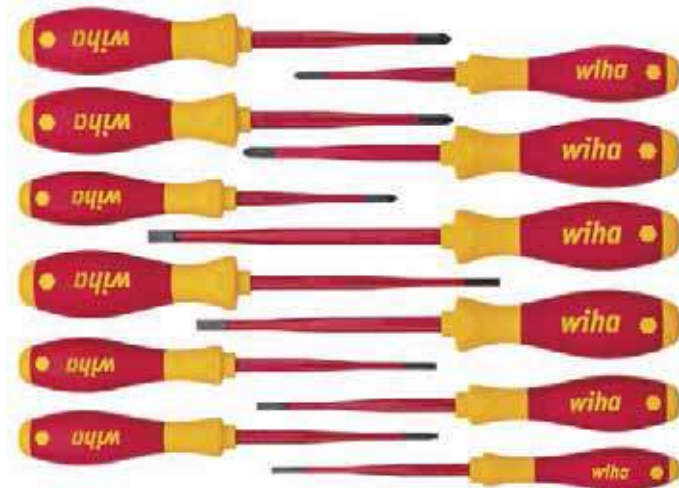

**Increases your efficiency:** Unique Wiha handle-length concept for optimum balance of torque and control. **Protects your health:** With the patented SoftFinish® handle design, ensuring work is kind to hands and muscles. Recommended by doctors and therapists at German Campaign for Healthier Backs. **Offers you full protection:** Each tool individually tested at 10,000 V AC and approved for 1,000 V AC. **Increases your safety:** Wiha slim blades ensure unlimited, protected access to deep-set screws.

assorted 12-pcs.

3201K12

Order-No.



41003

1

	3.5 mm x 100 mm / 4.0 mm x 100 mm / 5.5 mm x 125 mm / 6.5 mm x 150 mm
	PH1 x 80 mm / PH2 x 100 mm
	PZ1 x 1 mm / PZ2 x 100 mm
	SL/PZ2 x 100 mm
	T15 x 100 mm / T20 x 100 mm / T25 x 125 mm

No slim version  
Manufactured acc. to IEC 60900.

## INFOBOX: Handle size concept



### Wiha SoftFinish® handle sizes

- Every Wiha handle optimally balances guidance, speed and torque for the respective fastening task.
- Quick-turning - Motor skills are consistently taken into consideration.
- Maximum power transmission: comfortable and loss-free transmission of physical strength, even during intensive fastening.
- The power-turning and quick-turning zones (length) vary significantly over the four handle sizes in various forms.
- The Wiha SoftFinish screwdrivers enable work that is kind on the hands and muscles and is therefore recommended by doctors and therapists from the AGR.

## Screwdriver set SoftFinish® electric slimFix



**Increases your efficiency:** Unique Wiha handle-length concept for optimum balance of torque and control. **Protects your health:** With the patented SoftFinish® handle design, ensuring work is kind to hands and muscles. Recommended by doctors and therapists at German Campaign for Healthier Backs. **Offers you full protection:** Each tool individually tested at 10,000 V AC and approved for 1,000 V AC. **Increases your safety:** Wiha slim blades ensure unlimited, protected access to deep-set screws.

**Slotted, Phillips 6-pcs.**

3201K6

Order-No.



35389

1

3.5 mm x 100 mm / 4.0 mm x 100 mm / 5.5 mm x 125 mm / 6.5 mm x 150 mm

PH1 x 80 mm / PH2 x 100 mm

Manufactured acc. to IEC 60900.

**Slotted, Phillips, PlusMinus/Pozidriv 6-pcs.**

3201K601

Order-No.



38362

1

3.5 mm x 100 mm / 4.0 mm x 100 mm / 5.5 mm x 125 mm

PH1 x 80 mm / PH2 x 100 mm

SL/PZ2 x 100 mm

Manufactured acc. to IEC 60900.

**Slotted, Pozidriv 6-pcs**

3201ZK6

Order-No.



36455

1

3.5 mm x 100 mm / 4.0 mm x 100 mm / 5.5 mm x 125 mm / 6.5 mm x 150 mm

PZ1 x 1 mm / PZ2 x 100 mm

Manufactured acc. to IEC 60900.

**TORX® 6-pcs.**

3251K6

Order-No.



36558

1

T8 x 60 mm / T9 x 60 mm / T10 x 100 mm / T15 x 100 mm / T20 x 100 mm / T25 x 125 mm

T8 + T9 no slim version

Manufactured acc. to IEC 60900.

## Screwdriver SoftFinish® electric slimFix



**Increases your efficiency:** Unique Wiha handle-length concept for optimum balance of torque and control. **Protects your health:** With the patented SoftFinish® handle design, ensuring work is kind to hands and muscles. Recommended by doctors and therapists at German Campaign for Healthier Backs. **Offers you full protection:** Each tool individually tested at 10,000 V AC and approved for 1,000 V AC. **Increases your safety:** Wiha slim blades ensure unlimited, protected access to deep-set screws.

## Slotted

3201

Order-No.						
35446	3.5	100	0.6	204	23	10
35390	4.0	100	0.8	211	30	10
35501	4.5	125	1.0	236	30	10
35391	5.5	125	1.0	243	36	10
35392	6.5	150	1.2	268	36	10

Manufactured acc. to IEC 60900.

## Phillips

3211

Order-No.						
35393	PH1	80	191	30	10	
35394	PH2	100	218	36	10	

Manufactured acc. to IEC 60900.

## Pozidriv

3241

Order-No.						
35395	PZ1	1	191	30	10	
35396	PZ2	100	218	36	10	

Manufactured acc. to IEC 60900.

## PlusMinus/Phillips

3271

Order-No.						
35502	SL/PH1	80	191	30	10	
35503	SL/PH2	100	218	36	10	

Manufactured acc. to IEC 60900.

## PlusMinus/Pozidriv

3281

Order-No.						
36329	SL/PZ1	80	191	30	10	
36330	SL/PZ2	100	218	36	10	

Manufactured acc. to IEC 60900.

## TORX® Tamper Resistant (with hole)

3251TR

Order-No.						
41141	T10H	100	204	23	10	
41142	T15H	100	211	30	10	
41143	T20H	100	211	30	10	
41144	T25H	125	243	36	10	
41145	T27H	125	243	36	10	
41146	T30H	125	243	36	10	
41147	T40H	150	268	36	10	

Manufactured acc. to IEC 60900.

## TORX®

3251

Order-No.						
36536	T10	100	204	23	10	
36537	T15	100	211	30	10	
36538	T20	100	211	30	10	
36539	T25	125	243	36	10	
36540	T27	125	243	36	10	
36541	T30	125	243	36	10	
36542	T40	150	268	36	10	

Manufactured acc. to IEC 60900.

## Internal square

3581

Order-No.					
35504	#1	2.3	211	10	
35505	#2	2.8	243	10	

## Screwdriver set SoftFinish® electric



**Increases your efficiency:** Unique Wiha handle-length concept for optimum balance of torque and control. **Protects your health:** With the patented SoftFinish® handle design, ensuring work is kind to hands and muscles. Recommended by doctors and therapists at German Campaign for Healthier Backs. **Offers you full protection:** Each tool individually tested at 10,000 V AC and approved for 1,000 V AC.

## Slotted, Phillips 7-pcs.

320NK7

Order-No.



00834

1

➤ 2.5 mm x 75 mm / 4.0 mm x 100 mm / 5.5 mm x 125 mm / 6.5 mm x 150 mm

⊕ PH1 x 80 mm / PH2 x 100 mm

➤ Voltage tester SoftFinish® single-pole, 110-250 volts  
Slotted transparent, with push-on clip

Manufactured acc. to IEC 60900.

## Slotted, Pozidriv 6-pcs

320NZK6SO

Order-No.



25477

1

➤ 2.5 mm x 75 mm / 3.5 mm x 100 mm / 4.5 mm x 125 mm / 5.5 mm x 125 mm

⊕ PZ1 x 80 mm / PZ2 x 100 mm

Manufactured acc. to IEC 60900.

## Slotted, Phillips 6-pcs.

320NK6

Order-No.



00833

1

➤ 3.0 mm x 100 mm / 4.0 mm x 100 mm / 5.5 mm x 125 mm / 6.5 mm x 150 mm

⊕ PH1 x 80 mm / PH2 x 100 mm

Manufactured acc. to IEC 60900.

## Screwdriver SoftFinish® electric



**Increases your efficiency:** Unique Wiha handle-length concept for optimum balance of torque and control. **Protects your health:** With the patented SoftFinish® handle design, ensuring work is kind to hands and muscles. Recommended by doctors and therapists at German Campaign for Healthier Backs. **Offers you full protection:** Each tool individually tested at 10,000 V AC and approved for 1,000 V AC.

## Slotted

320N

Order-No.						
00819	2.0	60	0.4	164	23	10
00820	2.5	75	0.4	179	23	10
00821	3.0	100	0.5	204	23	10
00822	3.5	100	0.6	204	23	10
00823	4.0	100	0.8	211	30	10
00824	4.5	125	1.0	236	30	10
00825	4.5	175	1.0	286	30	5
31863	4.5	200	1.0	311	30	5
00826	5.5	125	1.0	243	36	10
00827	5.5	175	1.0	293	36	5
00828	6.0	150	1.2	268	36	10
00829	6.5	150	1.2	268	36	10
00830	8.0	175	1.2	299	41	10
00831	8.0	175	1.6	299	41	10
00832	10.0	200	1.6	324	41	5

Manufactured acc. to IEC 60900.

## Phillips

321N

Order-No.						
00846	PH0	60	164	23	10	
00847	PH1	80	191	30	10	
00848	PH2	100	218	36	10	
00849	PH3	150	268	41	10	
00850	PH4	200	318	41	5	

Manufactured acc. to IEC 60900.

## Pozidriv

324

Order-No.						
00877	PZ0	60	164	23	10	
00878	PZ1	80	191	30	10	
00879	PZ2	100	218	36	10	
00880	PZ3	150	324	41	5	

Manufactured acc. to IEC 60900.

## PlusMinus/Phillips

327

Order-No.						
30716	SL/PH1	80	191	30	10	
30715	SL/PH2	100	218	36	10	

Manufactured acc. to IEC 60900.

## PlusMinus/Pozidriv

328

Order-No.						
30700	SL/PZ1	80	191	30	10	
30701	SL/PZ2	100	218	36	10	

Manufactured acc. to IEC 60900.

## TORX®

325

Order-No.						
03760	T5	60	164	23	10	
03761	T6	60	164	23	10	
03762	T7	60	164	23	10	
00881	T8	60	164	23	10	
00882	T9	60	164	23	10	

Manufactured acc. to IEC 60900.

## Hex

323N

Order-No.						
30361	2.5	75	179	23	10	
30362	3.0	75	179	23	10	
30363	4.0	75	186	30	10	
30364	5.0	75	186	30	10	
30365	6.0	100	218	36	10	
30366	8.0	100	218	36	10	

Manufactured acc. to IEC 60900.

## Internal square

358N

Order-No.						
32396	#1	2.3	100	211	30	10
32397	#2	2.8	150	268	36	10

Manufactured acc. to IEC 60900.



Screwdriver set SoftFinish® electric



**Increases your efficiency:** Unique Wiha handle-length concept for optimum balance of torque and control. **Protects your health:** With the patented SoftFinish® handle design, ensuring work is kind to hands and muscles. Recommended by doctors and therapists at German Campaign for Healthier Backs. **Offers you full protection:** Each tool individually tested at 10,000 V AC and approved for 1,000 V AC.

Hexagon nut driver 5-pcs.

322K5

Order-No.	
29466	1
	5.5 mm x 125 mm / 7.0 mm x 125 mm / 8.0 mm x 125 mm / 10.0 mm x 125 mm / 13.0 mm x 125 mm







Manufactured acc. to IEC 60900.

Screwdriver set SoftFinish® electric



Hex nut driver

322

Order-No.						
00853	4.0	125	236	30	10.2	10
00855	5.0	125	236	30	11.2	10
00856	5.5	125	236	30	11.2	10
00857	6.0	125	236	30	12.2	10
00858	7.0	125	243	36	14.5	10
00859	8.0	125	243	36	15.2	10
00860	9.0	125	243	36	16	10
00861	10.0	125	243	36	17.2	10
00864	13.0	125	243	41	22.2	5
00862	11.0	125	243	41	19.2	5
00865	14.0	125	243	41	23.2	5
00863	12.0	125	243	41	20.2	5
00866	15.0	125	243	41	25.2	5
00867	16.0	125	243	41	25.2	5
00868	17.0	125	243	41	27.2	5

Manufactured acc. to IEC 60900.

INFOBOX:  
Combination profiles



PlusMinus.

- The special PlusMinus/Pozidriv profile is ideal for PlusMinus terminal screws.
- The combination profile reduces slipping out and guarantees a higher torque transmission.

Fine screwdriver set PicoFinish® electric



**Simplifies your work:** With a practical plastic holder to hang up or stand on a surface. **Makes handling easier:** Extra-long rotating cap ensures optimum feed. **Increases your efficiency:** Screwdriver handle size concept for optimal balance between precision and control. **Offers you full protection:** Each tool individually tested at 10,000 V AC and approved for 1,000 V AC. **Increases your efficiency:** Careful workmanship and controlled power transmission thanks to the slim handle with soft grip.

Slotted, Phillips, 7 pcs. incl. holder

2270PK601

Order-No.	Icon	Quantity
42989		1
	1 x 1.5 mm x 50 mm / 1 x 2.0 mm x 50 mm / 1 x 2.5 mm x 65 mm / 1 x 3.0 mm x 65 mm	
	1 x PH00 x 50 mm / 1 x PH0 x 65 mm	
	1 x holder	

PicoFinish® electric fine screwdriver



**Makes handling easier:** Extra-long rotating cap ensures optimum feed. **Increases your efficiency:** Screwdriver handle size concept for optimal balance between precision and control. **Offers you full protection:** Each tool individually tested at 10,000 V AC and approved for 1,000 V AC. **Increases your efficiency:** Careful workmanship and controlled power transmission thanks to the slim handle with soft grip.

Slotted

2270P

Order-No.	Icon 1	Icon 2	Icon 3	Icon 4	Icon 5	Icon 6
42374	1.5	50	2	152	18	10
42375	2.0	50	2	152	18	10
42376	2.5	65	2.5	167	18	10
42377	3.0	65	3	167	18	10
42471	3.5	65	3.5	167	18	10

Manufactured acc. to IEC 60900.

Phillips

2271P

Order-No.	Icon 1	Icon 2	Icon 3	Icon 4	Icon 5	Icon 6
42379	PH00	50	2	152	18	10
42378	PH0	65	3	167	18	10
42380	PH1	65	4	167	18	10

Manufactured acc. to IEC 60900.

INFOBOX:  
PicoFinish electric



**Wiha PicoFinish electric: The VDE-GS tested precision screwdriver.**

- The smooth-running turn-cap enables fast turning.
- Imprint with the screw symbol and sizes eases recognition.

L-key with T-handle electric



**Simplifies your work:** More power when fastening thanks to the leverage from the T-handle design **Increases your efficiency:** Handle size concept for an optimum balance between torque and control **Offers you full protection:** Each tool individually tested at 10,000 V AC and approved for 1,000 V AC.

Hex 334N

Order-No.						
27928	4.0	150	176	80	26	10
27929	5.0	150	182	100	32	10
27930	6.0	150	182	100	32	10
27931	8.0	150	182	100	32	10

Manufactured acc. to IEC 60900.

Nut driver with T-handle electric



**Simplifies your work:** More power when fastening thanks to the leverage from the T-handle design **Increases your efficiency:** Handle size concept for an optimum balance between torque and control **Offers you full protection:** Each tool individually tested at 10,000 V AC and approved for 1,000 V AC.

Hex 336N

Order-No.						
27932	8.0	200	232	100	32	10
27933	10.0	230	262	100	32	10
27934	13.0	230	262	100	32	10
27935	17.0	230	268	120	38	10

Manufactured acc. to IEC 60900.

Screw extractor set



**Increases your efficiency:** Thread-conserving removal of the screw without damage.

Hex, 17-pcs. with spiral drill bit incl. box 40511

Order-No.	
03988	1
	1 x 2.3 / 1 x 2.8 / 1 x 3.4 / 1 x 4.5 / 1 x 5.7 / 1 x 6.8 / 1 x 9.0 / 1 x 11
	1 x 2.0 mm / 1 x 2.5 mm / 1 x 3.0 mm / 1 x 4.0 mm / 1 x 5.0 mm / 1 x 6.0 mm / 1 x 8.0 mm / 1 x 10.0 mm
	1 x Box

Single, insulated open-end spanner



**Offers you full protection:** Each tool individually tested at 10,000 V AC and approved for 1,000 V AC. **Improved access:** Through the 15° position of jaws, light work is made of fastening even in restricted spaces.

5590N

Order-No.			
43026	6.0	90	1
43027	7.0	90	1
43028	8.0	100	1
43029	9.0	100	1
43030	10.0	110	1
43031	11.0	110	1
43032	12.0	130	1
43033	13.0	135	1
43034	14.0	145	1
43035	15.0	150	1
43036	16.0	160	1
43037	17.0	160	1
43038	18.0	175	1
43039	19.0	175	1
43040	22.0	195	1
43041	24.0	225	1
43042	27.0	250	1
43043	30.0	290	1
43044	32.0	310	1

Adjustable spanner electric



**Meets your requirements:** Continuously adjustable spanner width for a large application field. **Offers you full protection:** Each tool individually tested at 10,000 V AC and approved for 1,000 V AC.

Adjustable between 0-30 mm

5590NA

Order-No.			
43061	0 - 30	250	1

T-handle insulated for nut driver



**Offers you full protection:** Each tool individually tested at 10,000 V AC and approved for 1,000 V AC. **Improved access:** Deep-set screws can be reached easily.

24618T

Order-No.			
43063	1/2"	200	1
43062	3/8"	200	1

Ratchet wrench insulated for nut drivers



**Increases your flexibility:** Adjustable right or left rotation through switching lever. **Protects your health:** Reduction of the risk of injury by increasing the hand working space. **Offers you full protection:** Each tool individually tested at 10,000 V AC and approved for 1,000 V AC.

Switchable

7207NRW

Order-No.		mm	
43053	1/2"	250	1
43052	3/8"	200	1
43054	1/4"	145	1

Insulated nut driver insert



**Offers you full protection:** Each tool individually tested at 10,000 V AC and approved for 1,000 V AC.

1/2" hexagon head

7208NS

Order-No.		mm	
43077	10.0	55	1
43078	11.0	55	1
43079	12.0	55	1
43080	13.0	55	1
43081	14.0	55	1
43082	17.0	55	1
43083	19.0	55	1
43084	22.0	55	1
43085	24.0	55	1
43086	27.0	55	1
43087	32.0	55	1

Insulated nut driver insert



**Offers you full protection:** Each tool individually tested at 10,000 V AC and approved for 1,000 V AC.

3/8" hexagon head

7207NS

Order-No.		mm	
43065	8.0	45	1
43066	10.0	45	1
43067	11.0	45	1
43068	12.0	45	1
43069	13.0	45	1
43070	14.0	45	1
43071	16.0	45	1
43072	17.0	45	1
43073	18.0	45	1
43074	19.0	47	1
43075	21.0	47	1
43076	22.0	47	1

Insulated nut driver insert



**Offers you full protection:** Each tool individually tested at 10,000 V AC and approved for 1,000 V AC. **Protects your material:** Fully insulated tool reduces the risk of short circuits.

1/4" hexagon head

7209NS

Order-No.		mm	
43088	4.0	42	1
43089	5.0	42	1
43090	5.5	42	1
43091	6.0	42	1
43092	7.0	42	1
43093	8.0	42	1
43094	9.0	42	1
43095	10.0	42	1
43096	11.0	42	1
43097	12.0	42	1
43098	13.0	42	1
43099	14.0	42	1

## Insulated nut driver insert



**Offers you full protection:** Each tool individually tested at 10,000 V AC and approved for 1,000 V AC.

## 1/2" hexagon head

7208NHS

Order-No.			
43100	4.0	120	1
43101	5.0	120	1
43102	6.0	120	1
43103	8.0	120	1
43104	10.0	120	1

## Insulated nut driver insert



**Offers you full protection:** Each tool individually tested at 10,000 V AC and approved for 1,000 V AC.

## 3/8" hexagon head

7207NHS

Order-No.			
43105	4.0	75	1
43106	5.0	75	1
43107	6.0	75	1
43108	8.0	75	1

## Insulated nut driver insert



**Offers you full protection:** Each tool individually tested at 10,000 V AC and approved for 1,000 V AC.

## 1/4" internal hexagon

7209NHS

Order-No.			
43109	3.0	65	1
43110	4.0	65	1
43111	5.0	65	1
43112	6.0	65	1
43113	8.0	65	1

## Insulated extension



**Offers you full protection:** Each tool individually tested at 10,000 V AC and approved for 1,000 V AC. **Improved access:** Deep-set screws can be reached easily.

## 1/2" for nut driver inserts, insulated

7208NEX

Order-No.			
43055	1/2"	125	1
43056	1/2"	250	1

## 3/8" for nut driver inserts, insulated

7207NEX

Order-No.			
43057	3/8"	125	1
43058	3/8"	250	1

## 1/4" for nut driver inserts, insulated

7209NEX

Order-No.			
43059	1/4"	75	1
43060	1/4"	150	1

## Insulated square adapter



**Offers you full protection:** Each tool individually tested at 10,000 V AC and approved for 1,000 V AC. **Increases your efficiency:** Adapter allows 1/4" nut driver fastening with the 3/8" torque key.

## 3/8" for 1/4" nut driver

283799

Order-No.			
44355	1/4"	100	1

Universal key with double joint



**Makes handling easier:** Can be used as a slim pin or as a powerful T-handle thanks to the double joint. **Increases your efficiency:** 8 key profiles combined in a compact and light tool.

with triangular heads, square heads and double bit

24682

Order-No.				
44001	7-9	3-5	5-8	1

Switch cabinet key cross shape



**Increases your efficiency:** All keys and profiles integrated into one compact, lightweight tool.

24667

Order-No.						
36114	5-8	9	3-5	7.0	PH2	5

Screwdriver SoftFinish®



**Simplifies your work:** Striking cap integrated into the handle allows you to strike and lift with the screwdriver. **Makes handling easier:** Easy loosening of tight screws thanks to hex bolster for spanners. **Protects your health:** With the patented SoftFinish® handle design, ensuring work is kind to hands and muscles. Recommended by doctors and therapists at German Campaign for Healthier Backs. **Increases your efficiency:** Screwdriver handle size concept for optimal balance between precision and control.

Slotted with one-piece hexagonal blade and solid steel cap

530

Order-No.										
03223	3.5•	75	0.6	4		186	30	10		
03224	4.5•	90	0.8	4		201	30	10		
03225	5.5•	100	1.0	5	8	213	36	10		
03226	6.5•	125	1.2	6	10	238	36	10		
03228	8.0•	150	1.2	8	13	271	41	5		
03230	10.0•	175	1.6	8	13	296	41	5		
03231	12.0•	200	2.0	10	16	321	41	5		
03232	14.0•	250	2.5	10	16	371	41	5		

• Additional dimension. Non-DIN size.

Phillips with one-piece hexagonal blade and solid steel cap

531

Order-No.										
03237	PH1	80	5	8	186	30	10			
03238	PH2	100	6	10	213	36	10			
03239	PH3	150	8	13	268	41	10			

Pozidriv with one-piece hexagonal blade and solid steel cap

532

Order-No.										
03245	PZ1	80	5	8	186	30	10			
03246	PZ2	100	6	10	213	36	10			
03247	PZ3	150	8	13	268	41	10			

INFOBOX:  
Solid steel cap and hexagon head



- The solid steel cap at the end of the screwdriver handle enables targeted hammering, e.g. to loosen jammed screws.
- The direct connection of the solid steel cap to the blade means that the impact energy is transmitted without any loss.
- Blade includes a hexagon bolster for using a set of spanners for additional torque.

Screwdriver SoftFinish®



**Increases your efficiency:** Unique Wiha handle-length concept for optimum balance of torque and control. **Protects your health:** With the patented SoftFinish® handle design, ensuring work is kind to hands and muscles. Recommended by doctors and therapists at German Campaign for Healthier Backs.

Slotted with round blade for low-lying screws

302

Order-No.							
00689	3.0	150	0.5	3	254	23	10
00690	3.0	200	0.5	3	304	23	10
32383	3.0	300	0.5	3	404	23	5
00691	3.5	100	0.6	3.5	204	23	10
26931	3.5	200	0.6	3.5	304	23	10
00692	4.0	100	0.8	4	211	30	10
00694	4.0	150	0.8	4	261	30	10
00695	4.0	200	0.8	4	311	30	10
00696	4.0	300	0.8	4	411	30	5
00697	4.5	125	0.8	4.5	236	30	10
27753	4.5	80	0.8	4.5	191	30	10
00698	5.5	125	1.0	5.5	236	30	10
00700	5.5	150	1.0	5.5	261	30	10
00701	5.5	200	1.0	5.5	311	30	10
00702	5.5	300	1.0	5.5	411	30	5
32384	6.0	300	1.0	6	418	36	5
00684	2.0	65	0.4	2	169	23	10
00685	2.5	75	0.4	2.5	179	23	10
00686	3.0	80	0.5	3	184	23	10
00687	3.0	100	0.5	3	204	23	10

Screwdriver SoftFinish®



**Increases your efficiency:** Unique Wiha handle-length concept for optimum balance of torque and control. **Protects your health:** With the patented SoftFinish® handle design, ensuring work is kind to hands and muscles. Recommended by doctors and therapists at German Campaign for Healthier Backs.

Slotted with round blade

3022

Order-No.							
27754	6.0	100	1.0	5.5	218	36	10
27755	6.0	150	1.0	5.5	268	36	10
00704	6.5	100	1.2	6	218	36	10
00703	6.5	150	1.2	6	268	36	10
00706	6.5	200	1.2	6	318	36	10
00708	8.0	150	1.2	7	274	41	10
00707	8.0	175	1.2	7	299	41	5
00709	8.0	175	1.6	7	299	41	5
32399	8.0	300	1.2	7	424	41	5
00711	10.0	200	1.6	8	324	41	5
32400	10.0	300	1.6	8	424	41	5
00712	12.0	250	2.0	8	374	41	5
00713	14.0	250	2.5	11	374	41	5

## Screwdriver with bit magazine LiftUp 25 magnetic



**Simplifies your work:** Larger handle – maximum power. **Increases your efficiency:** 90% less volume, 80% less weight – 100% efficiency. **Increases your flexibility:** Standard bits are also suitable for machine operation. **Protects your health:** No risk of injury, \*all bits stowed safely inside the handle.

## assorted with 12 bits, 1/4" in blister pack

SB380302020

Order-No.	SB	
38605	x	5
➔		1 x 4.5 mm / 1 x 6.5 mm
⊕		1 x PH1 / 1 x PH2 / 1 x PH3
⊕		1 x PZ1 / 1 x PZ2 / 1 x PZ3
⊕		1 x T15 / 1 x T20 / 1 x T25 / 1 x T30

## assorted with 12 bits, 1/4"

SB380302021

Order-No.	SB	
38606	x	5
➔		1 x 5.5 mm
⊕		1 x PH2
⊕		1 x PZ1 / 1 x PZ2 / 1 x PZ3
⊕		1 x T15 / 1 x T20 / 1 x T25 / 1 x T30
⊕		1 x 3.0 mm / 1 x 4.0 mm / 1 x 5.0 mm

## Screwdriver with bit magazine PocketMax® magnetic



**Increases your efficiency:** Your daily companion – always have the relevant profiles with you. **Increases your flexibility:** Standard bits are also suitable for machine operation. **Saves space:** Compact and light tool, fits into any pants pockets. **Protects your health:** No risk of injury, \*all bits stowed safely inside the handle.

## Mixed with 8 bits, 1/4"

SB3803050

Order-No.	SB	
45292		1
➔		4.5 mm / 6.5 mm
⊕		PH1 / PH2
⊕		PZ1 / PZ2
⊕		T15 / T20

## Screwdriver with bit magazine magnetic



**Increases your efficiency:** Good access to confined spaces due to extremely short screwdriver handle. **Saves space:** Six tools in one.

## Phillips slotted with 6 bits, Stubby, 1/4"

SB380101

Order-No.	SB	
33738	x	5
➔		1 x 4.5 mm / 1 x 6.5 mm
⊕		1 x PH1 / 1 x PH2 / 1 x PH3

## Poizidriv, Phillips with 6 bits, Stubby, 1/4" in blister pack

SB380102

Order-No.	SB	
33741	x	5
⊕		1 x PH1 / 1 x PH2 / 1 x PH3
⊕		1 x PZ1 / 1 x PZ2 / 1 x PZ3

## TORX® with 6 bits, Stubby, 1/4"

SB380103

Order-No.	SB	
33744	x	5
⊕		1 x T10 / 1 x T15 / 1 x T20 / 1 x T25 / 1 x T30 / 1 x T40

## Slotted, Poizidriv with 6 bits, Stubby, 1/4"

SB380104

Order-No.	SB	
33746	x	5
➔		1 x 4.5 mm / 1 x 6.5 mm
⊕		1 x PZ1 / 1 x PZ2 / 1 x PZ3

# Three. For all your jobs.



Which machine? Which application? Which bit? The revolutionary Wiha bit concept puts an end to any confusion and presents three bit types which can cover all areas of use. Only the screw shape is crucial for selecting the bit. The Y bit is ideal for fastening wood screws with an angle no greater than 90° between the thread and screw head. The T bit is used for metal screws at a 90° angle. If you need to fasten both screw types, then the TY bit is the right choice since this universal bit is suitable for all type of fastenings.

- Increases your efficiency**  
 The specialist with 120x greater lifespan\* thanks to optimised bits. \* Compared to Wiha standard bits.
- Lowers your costs**  
 Bit quick and easy to find thanks to marking – even in dark environments when a UV light is used.
- Saves time**  
 No long searches thanks to fluorescent bit, infrequent bit replacement thanks to long lifespan.

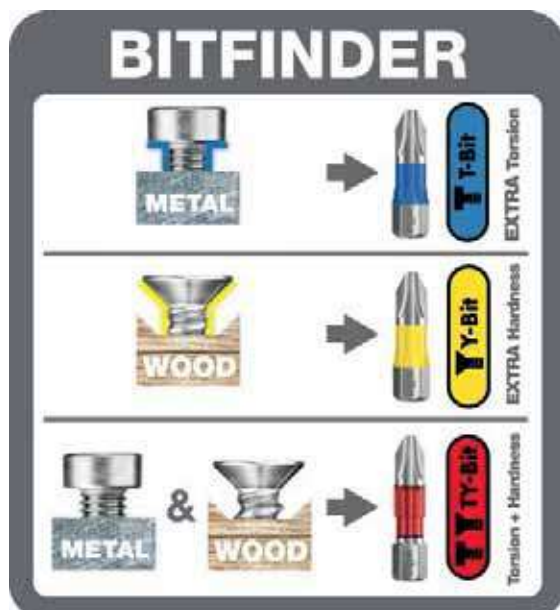

## BitBuddy® TY bit set, 49 mm



**Increases your efficiency:** The all-rounder with 120x greater lifespan\* thanks to patented bit technology, suitable for all screws. (\*compared to Wiha standard bit) **Lowers your costs:** Bit quick and easy to find thanks to red marking – even in dark environments by using an UV light. **Saves time:** No long searches thanks to fluorescent bit, infrequent bit replacement thanks to long lifespan. **Saves time:** Automatic opening at the push of a button and simple bit change directly in the holder.

**Pozidriv 8-pcs. 1/4" E6,3**

SB7946TY202

Order-No.



42099

6

1 x TY-Bit 49 mm Pozidriv 1/4" PZ1 / 5 x TY-Bit 49 mm Pozidriv 1/4" PZ2 / 1 x TY-Bit 49 mm Pozidriv 1/4" PZ3  
1 x BitBuddy®

\* compared to Wiha standard bit

**Phillips, Pozidriv, TORX®, 8-pcs., 1/4" E6,3**

SB7946TY903

Order-No.



42116

6

1 x TY-Bit 49 mm Phillips 1/4" PH2  
1 x TY-Bit 49 mm Pozidriv 1/4" PZ1 / 1 x TY-Bit 49 mm Pozidriv 1/4" PZ2 / 1 x TY-Bit 49 mm Pozidriv 1/4" PZ3  
1 x TY-Bit 49 mm TORX® 1/4" T15 / 1 x TY-Bit 49 mm TORX® 1/4" T20 / 1 x TY-Bit 49 mm TORX® 1/4" T25  
1 x BitBuddy®

\* compared to Wiha standard bit

**TORX® 8-pcs. 1/4" E6,3**

SB7946TY505

Order-No.



42115

6

1 x TY-Bit 49 mm TORX® 1/4" T10 / 1 x TY-Bit 49 mm TORX® 1/4" T15 / 2 x TY-Bit 49 mm TORX® 1/4" T20 / 1 x TY-Bit 49 mm TORX® 1/4" T25 / 1 x TY-Bit 49 mm TORX® 1/4" T30 / 1 x TY-Bit 49 mm TORX® 1/4" T40  
1 x BitBuddy®

\* compared to Wiha standard bit

**Phillips, Pozidriv, TORX®, 8-pcs., 1/4" E6,3**

SB7946TY904

Order-No.



42117

6

1 x TY-Bit 49 mm Phillips 1/4" PH2  
1 x TY-Bit 49 mm Pozidriv 1/4" PZ1 / 1 x TY-Bit 49 mm Pozidriv 1/4" PZ2  
1 x TY-Bit 49 mm TORX® 1/4" T10 / 1 x TY-Bit 49 mm TORX® 1/4" T15 / 1 x TY-Bit 49 mm TORX® 1/4" T20 / 1 x TY-Bit 49 mm TORX® 1/4" T25  
1 x BitBuddy®

\* compared to Wiha standard bit

**Hexagon 8-pcs. 1/4" E6,3**

SB7946TY303

Order-No.



42114

6

2 x TY-Bit 49 mm Hex 1/4" SW3 / 2 x TY-Bit 49 mm Hex 1/4" SW4 / 2 x TY-Bit 49 mm Hex 1/4" SW5 / 1 x TY-Bit 49 mm Hex 1/4" SW6  
1 x BitBuddy®

\* compared to Wiha standard bit

**Pozidriv, TORX® 8-pcs. 1/4" E6,3**

SB7946TY905

Order-No.



42118

6

1 x TY-Bit 49 mm Pozidriv 1/4" PZ2 / 1 x TY-Bit 49 mm Pozidriv 1/4" PZ3  
1 x TY-Bit 49 mm TORX® 1/4" T15 / 1 x TY-Bit 49 mm TORX® 1/4" T20 / 1 x TY-Bit 49 mm TORX® 1/4" T25 / 1 x TY-Bit 49 mm TORX® 1/4" T30 / 1 x TY-Bit 49 mm TORX® 1/4" T40  
1 x BitBuddy®

\* compared to Wiha standard bit

BitBuddy® TY bit set, 29 mm



**Increases your efficiency:** The all-rounder with 120x greater lifespan\* thanks to patented bit technology, suitable for all screws. (\*compared to Wiha standard bit) **Lowers your costs:** Bit quick and easy to find thanks to red marking – even in dark environments by using an UV light. **Saves time:** Automatic opening at the push of a button and simple bit change directly in the holder. **Saves time:** No long searches thanks to fluorescent bit, infrequent bit replacement thanks to long lifespan.

**Pozidriv 9-pcs. 1/4" C6,3**

SB7945TY202

Order-No.	
42098	6
	1 x TY-Bit 29 mm Pozidriv 1/4" PZ1 / 5 x TY-Bit 29 mm Pozidriv 1/4" PZ2 / 1 x TY-Bit 29 mm Pozidriv 1/4" PZ3
	1 x Bit holder magnetic 60 mm 1/4"extra strong magnet in box
	1 x BitBuddy®

\* compared to Wiha standard bit

**Phillips, Pozidriv, TORX®, 9-pcs., 1/4" C6,3**

SB7945TY903

Order-No.	
42137	6
	1 x TY-Bit 29 mm Phillips 1/4" PH2
	1 x TY-Bit 29 mm Pozidriv 1/4" PZ1 / 1 x TY-Bit 29 mm Pozidriv 1/4" PZ2 / TY-Bit 29 mm Pozidriv 1/4" PZ3
	1 x TY-Bit 29 mm TORX® 1/4" T15 / 1 x TY-Bit 29 mm TORX® 1/4" T20 / 1 x TY-Bit 29 mm TORX® 1/4" T25
	1 x Bit holder magnetic 60 mm 1/4"extra strong magnet in box
	1 x BitBuddy®

\* compared to Wiha standard bit

**Hexagon 9-pcs. 1/4" C6,3**

SB7945TY303

Order-No.	
42135	6
	2 x TY-Bit 29 mm Hex 1/4" SW3 / 2 x TY-Bit 29 mm Hex 1/4" SW4 / 2 x TY-Bit 29 mm Hex 1/4" SW5 / 1 x TY-Bit 29 mm Hex 1/4" SW6
	1 x Bit holder magnetic 60 mm 1/4"extra strong magnet in box
	1 x BitBuddy®

\* compared to Wiha standard bit

**Phillips, Pozidriv, TORX®, 9-pcs., 1/4" C6,3**

SB7945TY904

Order-No.	
42138	6
	1 x TY-Bit 29 mm Phillips 1/4" PH2
	1 x TY-Bit 29 mm Pozidriv 1/4" PZ1 / 1 x TY-Bit 29 mm Pozidriv 1/4" PZ2
	1 x TY-Bit 29 mm TORX® 1/4" T10 / 1 x TY-Bit 29 mm TORX® 1/4" T15 / 1 x TY-Bit 29 mm TORX® 1/4" T20 / 1 x TY-Bit 29 mm TORX® 1/4" T25
	1 x Bit holder magnetic 60 mm 1/4"extra strong magnet in box
	1 x BitBuddy®

\* compared to Wiha standard bit

**TORX® 9-pcs. 1/4" C6,3**

SB7945TY505

Order-No.	
42136	6
	1 x TY-Bit 29 mm TORX® 1/4" T10 / 1 x TY-Bit 29 mm TORX® 1/4" T15 / 1 x TY-Bit 29 mm TORX® 1/4" T20 / 1 x TY-Bit 29 mm TORX® 1/4" T25 / 1 x TY-Bit 29 mm TORX® 1/4" T30 / 1 x TY-Bit 29 mm TORX® 1/4" T40
	1 x Bit holder magnetic 60 mm 1/4"extra strong magnet in box
	1 x BitBuddy®

\* compared to Wiha standard bit

**Pozidriv, TORX® 9-pcs. 1/4" C6,3**

SB7945TY905

Order-No.	
42139	6
	1 x TY-Bit 29 mm Pozidriv 1/4" PZ2 / 1 x TY-Bit 29 mm Pozidriv 1/4" PZ3
	1 x TY-Bit 29 mm TORX® 1/4" T15 / 1 x TY-Bit 29 mm TORX® 1/4" T20 / 1 x TY-Bit 29 mm TORX® 1/4" T25 / 1 x TY-Bit 29 mm TORX® 1/4" T30 / 1 x TY-Bit 29 mm TORX® 1/4" T40
	1 x Bit holder magnetic 60 mm 1/4"extra strong magnet in box
	1 x BitBuddy®

\* compared to Wiha standard bit

## XLSelector T bit set, 50 mm



**Increases your efficiency:** The specialist with 120x greater lifespan\* thanks to optimised bit for T-shaped screws(\*compared to Wiha standard bit) **Lowers your costs:** Bit quick and easy to find thanks to blue marking – even in dark environments by using an UV light. **Saves time:** No long searches thanks to fluorescent bit, infrequent bit replacement thanks to long lifespan.

## Phillips, TORX®, hex 14-pcs. 1/4" E6,3

SB7948T950

Order-No.		
41831		6
	1 x T-Bit 50 mm Phillips 1/4" PH1 / 1 x T-Bit 50 mm Phillips 1/4" PH2 / 1 x T-Bit 50 mm Phillips 1/4" PH3	
	1 x T-Bit 50 mm TORX® 1/4" T15 / 1 x T-Bit 50 mm TORX® 1/4" T20 / 1 x T-Bit 50 mm TORX® 1/4" T25 / 1 x T-Bit 50 mm TORX® 1/4" T30 / 1 x T-Bit 50 mm TORX® 1/4" T40	
	1 x T-Bit 50 mm Hexagon 1/4" SW3 / 1 x T-Bit 50 mm Hexagon 1/4" SW4 / 1 x T-Bit 50 mm Hexagon 1/4" SW5 / 1 x T-Bit 50 mm Hexagon 1/4" SW6	
	1 x Bit holder magnetic 58 mm 1/4"	
	1 x XLSelector	

\* compared to Wiha standard bit

## XLSelector T bit set, 25 mm



**Increases your efficiency:** The specialist with 120x greater lifespan\* thanks to optimised bit for T-shaped screws(\*compared to Wiha standard bit) **Lowers your costs:** Bit quick and easy to find thanks to blue marking – even in dark environments by using an UV light. **Saves time:** No long searches thanks to fluorescent bit, infrequent bit replacement thanks to long lifespan.

## Phillips, TORX®, hex 32-pcs. 1/4" C6,3

SB7948T999

Order-No.		
41830		6
	2 x T-Bit 25 mm Phillips 1/4" PH1 / 4 x T-Bit 25 mm Phillips 1/4" PH2 / 2 x T-Bit 25 mm Phillips 1/4" PH3	
	2 x T-Bit 25 mm TORX® 1/4" T10 / 2 x T-Bit 25 mm TORX® 1/4" T15 / 4 x T-Bit 25 mm TORX® 1/4" T20 / 2 x T-Bit 25 mm TORX® 1/4" T25 / 2 x T-Bit 25 mm TORX® 1/4" T30 / 2 x T-Bit 25 mm TORX® 1/4" T40	
	2 x T-Bit 25 mm Hexagon 1/4" SW3 / 2 x T-Bit 25 mm Hexagon 1/4" SW4 / 2 x T-Bit 25 mm Hexagon 1/4" SW5 / 2 x T-Bit 25 mm Hexagon 1/4" SW6	
	1 x Bit holder magnetic 58 mm 1/4"	
	1 x XLSelector	

\* compared to Wiha standard bit

FlipSelector T bit set, 25 mm



**Increases your efficiency:** The specialist with 120x greater lifespan\* thanks to optimised bit for T-shaped screws(\*compared to Wiha standard bit) **Lowers your costs:** Bit quick and easy to find thanks to blue marking – even in dark environments by using an UV light. **Saves time:** No long searches thanks to fluorescent bit, infrequent bit replacement thanks to long lifespan. **Saves time:** Simple and rapid bit removal thanks to clear organisation and automatic opening at the push of a button.

**Hexagon 14-pcs. 1/4" C6,3**

SB7947T303

Order-No.	
41825	6
	3 x T-Bit 25 mm Hexagon 1/4" SW3 / 3 x T-Bit 25 mm Hexagon 1/4" SW4 / 3 x T-Bit 25 mm Hexagon 1/4" SW5 / 3 x T-Bit 25 mm Hexagon 1/4" SW6
	1 x Bit holder magnetic 60 mm 1/4"extra strong magnet in box
	1 x FlipSelector

\* compared to Wiha standard bit

**Phillips, Pozidriv, TORX®, 14-pcs., 1/4" C6,3**

SB7947T906

Order-No.	
41824	6
	1 x T-Bit 25 mm Phillips 1/4" PH1 / 3 x T-Bit 25 mm Phillips 1/4"PH2 / 1 x T-Bit 25 mm Phillips 1/4" PH3
	1 x T-Bit 25 mm Pozidriv 1/4" PZ2
	1 x T-Bit 25 mm TORX® 1/4" T10 / 1 x T-Bit 25 mm TORX® 1/4" T15 / 1 x T-Bit 25 mm TORX® 1/4" T20 / 1 x T-Bit 25 mm TORX® 1/4" T25 / 1 x T-Bit 25 mm TORX® 1/4" T30 / 1 x T-Bit 25 mm TORX® 1/4" T40
	1 x Bit holder magnetic 60 mm 1/4"extra strong magnet in box
	1 x FlipSelector

\* compared to Wiha standard bit

**assorted 14-pcs. 1/4" C6,3**

SB7947T999

Order-No.	
41826	6
	1 x T-Bit 25 mm Phillips 1/4" PH1 / 1 x T-Bit 25 mm Phillips 1/4"PH2 / 1 x T-Bit 25 mm Phillips 1/4" PH3
	1 x T-Bit 25 mm Pozidriv 1/4" PZ2
	1 x T-Bit 25 mm TORX® 1/4" T15 / 1 x T-Bit 25 mm TORX® 1/4" T20 / 1 x T-Bit 25 mm TORX® 1/4" T25 / 1 x T-Bit 25 mm TORX® 1/4" T30 / 1 x T-Bit 25 mm TORX® 1/4" T40
	1 x T-Bit 25 mm Hexagon 1/4" SW4 / 1 x T-Bit 25 mm Hexagon 1/4" SW5 / 1 x T-Bit 25 mm Hexagon 1/4" SW6
	1 x Bit holder magnetic 60 mm 1/4"extra strong magnet in box
	1 x FlipSelector

\* compared to Wiha standard bit

Fastening / jamming

## XLSelector Y bit set, 50 mm



**Increases your efficiency:** The specialist with 120x greater lifespan\* thanks to optimised bit for Y-shaped screws(\*compared to Wiha standard bit) **Lowers your costs:** Bit quick and easy to find thanks to yellow marking – even in dark environments by using an UV light. **Saves time:** No long searches thanks to fluorescent bit, infrequent bit replacement thanks to long lifespan.

## Phillips, Pozidriv, TORX®, 14-pcs., 1/4" E6,3





SB7948Y950

Order-No.



41834

6

-  2 x Y-Bit 50 mm Pozidriv 1/4" PH2
-  1 x Y-Bit 50 mm Pozidriv 1/4" PZ1 / 2 x Y-Bit 50 mm Pozidriv 1/4" PZ2 / 1 x Y-Bit 50 mm Pozidriv 1/4" PZ3
-  1 x Y-Bit 50 mm TORX® 1/4" T10 / 1 x Y-Bit 50 mm TORX® 1/4" T15 / 1 x Y-Bit 50 mm TORX® 1/4" T20 / 1 x Y-Bit 50 mm TORX® 1/4" T25 / 1 x Y-Bit 50 mm TORX® 1/4" T30 / 1 x Y-Bit 50 mm TORX® 1/4" T40
-  1 x Bit holder magnetic 58 mm 1/4"
- 1 x XLSelector

\* compared to Wiha standard bit

## XLSelector Y bit set, 25 mm



**Increases your efficiency:** The specialist with 120x greater lifespan\* thanks to optimised bit for Y-shaped screws(\*compared to Wiha standard bit) **Lowers your costs:** Bit quick and easy to find thanks to yellow marking – even in dark environments by using an UV light. **Saves time:** No long searches thanks to fluorescent bit, infrequent bit replacement thanks to long lifespan.

## TORX® 32-pcs. 1/4" C6,3



SB7948Y505

Order-No.



41833

6

-  3 x Y-Bit 25 mm TORX® 1/4" T10 / 6 x Y-Bit 25 mm TORX® 1/4" T15 / 6 x Y-Bit 25 mm TORX® 1/4" T20 / 6 x Y-Bit 25 mm TORX® 1/4" T25 / 6 x Y-Bit 25 mm TORX® 1/4" T30 / 3 x Y-Bit 25 mm TORX® 1/4" T40
-  1 x Bit holder magnetic 58 mm 1/4"
- 1 x XLSelector

\* compared to Wiha standard bit

## Phillips, Pozidriv, TORX®, 32-pcs., 1/4" C6,3



SB7948Y904

Order-No.



41832

6

-  1 x Y-Bit 25 mm Phillips 1/4" PH1 / 4 x Y-Bit 25 mm Phillips 1/4" PH2 / 1 x Y-Bit 25 mm Phillips 1/4" PH3
-  2 x Y-Bit 25 mm Pozidriv 1/4" PZ1 / 4 x Y-Bit 25 mm Pozidriv 1/4" PZ2 / 2 x Y-Bit 25 mm Pozidriv 1/4" PZ3
-  2 x Y-Bit 25 mm TORX® 1/4" T10 / 3 x Y-Bit 25 mm TORX® 1/4" T15 / 3 x Y-Bit 25 mm TORX® 1/4" T20 / 3 x Y-Bit 25 mm TORX® 1/4" T25 / 3 x Y-Bit 25 mm TORX® 1/4" T30 / 2 x Y-Bit 25 mm TORX® 1/4" T40
-  1 x Bit holder magnetic 58 mm 1/4"
- 1 x XLSelector

\* compared to Wiha standard bit

FlipSelector Y bit set, 25 mm



**Increases your efficiency:** The specialist with 120x greater lifespan\* thanks to optimised bit for Y-shaped screws>(\*compared to Wiha standard bit) **Lowers your costs:** Bit quick and easy to find thanks to yellow marking – even in dark environments by using an UV light. **Saves time:** Simple and rapid bit removal thanks to clear organisation and automatic opening at the push of a button. **Saves time:** No long searches thanks to fluorescent bit, infrequent bit replacement thanks to long lifespan.

**Pozidriv 14-pcs. 1/4" C6,3**

SB7947Y202

Order-No.	
41829	6
	2 x Y-Bit 25 mm Pozidriv 1/4" PZ1 / 8 x Y-Bit 25 mm Pozidriv 1/4" PZ2 / 2 x Y-Bit 25 mm Pozidriv 1/4" PZ3
	1 x Bit holder magnetic 60 mm 1/4"extra strong magnet in box
	1 x FlipSelector

\* compared to Wiha standard bit

**TORX® 14-pcs. 1/4" C6,3**

SB7947Y505

Order-No.	
41828	6
	2 x Y-Bit 25 mm TORX® 1/4" T10 / 2 x Y-Bit 25 mm TORX® 1/4" T15 / 3 x Y-Bit 25 mm TORX® 1/4" T20 / 2 x Y-Bit 25 mm TORX® 1/4" T25 / 2 x Y-Bit 25 mm TORX® 1/4" T30 / 1 x Y-Bit 25 mm TORX® 1/4" T40
	1 x Bit holder magnetic 60 mm 1/4"extra strong magnet in box
	1 x FlipSelector

\* compared to Wiha standard bit

**Phillips, Pozidriv, TORX®, 14-pcs., 1/4" C6,3**

SB7947Y904

Order-No.	
41827	6
	1 x Y-Bit 25 mm Phillips 1/4" PH2
	1 x Y-Bit 25 mm Pozidriv 1/4" PZ1 / 2 x Y-Bit 25 mm Pozidriv 1/4" PZ2 / 1 x Y-Bit 25 mm Pozidriv 1/4" PZ3
	1 x Y-Bit 25 mm TORX® 1/4" T10 / 1 x Y-Bit 25 mm TORX® 1/4" T15 / 1 x Y-Bit 25 mm TORX® 1/4" T20 / 1 x Y-Bit 25 mm TORX® 1/4" T25 / 1 x Y-Bit 25 mm TORX® 1/4" T30 / 1 x Y-Bit 25 mm TORX® 1/4" T40
	1 x Bit holder magnetic 60 mm 1/4"extra strong magnet in box
	1 x FlipSelector

\* compared to Wiha standard bit





## Bit set XLSelector Standard 25 mm



**Meets your requirements:** Robust and precise bits for general fastening in trade and industry. **Increases your efficiency:** All standard 25 mm bits organised in a compact, space-saving design. **Saves time:** Simple and quick recognition of profile sizes thanks to contrasting laser marking.







## assorted 32-pcs. 1/4" C6,3

7948005

Order-No.		
29417	5	
	1 x 4.5 mm / 1 x 5.5 mm / 1 x 6.5 mm	
	2 x PH1 / 4 x PH2 / 1 x PH3	
	2 x PZ1 / 5 x PZ2 / 1 x PZ3	
	2 x T10 / 2 x T15 / 2 x T20 / 3 x T25 / 2 x T30 / 1 x T40	
	1 x Bit holder magnetic 58 mm 1/4"	
	1 x XLSelector	

## assorted 32-pcs. 1/4" C6,3

7948927







Order-No.		
29416	5	
	1 x 0 / 1 x 1 / 1 x 2 / 1 x 3 / 1 x 4	
	1 x 4 / 1 x 6 / 1 x 8 / 1 x 10	
	1 x TR2,0 / 1 x TR2,5 / 1 x TR3,0 / 1 x TR4,0 / 1 x TR5,0 / 1 x TR6,0	
	1 x 6 / 1 x 8 / 1 x 10	
	1 x T8H / 1 x T9H / 1 x T10H / 1 x T15H / 1 x T20H / 1 x T25H / 1 x T27H / 1 x T30H / 1 x T40H	
	1 x #1 / 1 x #2 / 1 x #3	
	1 x CentroFix quick change holder, magnetic, form E 6.3	
	1 x XLSelector	

## Bit set FlipSelector Standard 25 mm







## Mixed, 15-pcs. 1/4" C6,3 with belt clip

SB7947999

Order-No.		
39083	x	5
	1 x 5.5 mm	
	1 x PH2	
	1 x PZ1 / 1 x PZ2 / 1 x PZ3	
	1 x T15 / 1 x T20 / 1 x T25 / 1 x T30	
	1 x 3.0 mm / 1 x 4.0 mm / 1 x 5.0 mm	
	1 x Bit holder magnetic 58 mm 1/4"	
	1 x Belt clip	
	1 x FlipSelector	





## Slotted, Phillips, Pozidriv, 13-pcs., 1/4" with belt clip

SB7947005

Order-No.		
39049	x	5
	1 x 5.5 mm	
	1 x PH1 / 3 x PH2 / 1 x PH3	
	1 x PZ1 / 4 x PZ2 / 1 x PZ3	
	1 x Bit holder magnetic 58 mm 1/4"	
	1 x Belt clip	
	1 x FlipSelector	



## Phillips, Pozidriv, TORX®, 15-pcs., 1/4" with belt clip

SB7947904





Order-No.		
39060	x	5
	2 x PH2	
	1 x PZ1 / 2 x PZ2 / 1 x PZ3	
	1 x T10 / 1 x T15 / 1 x T20 / 1 x T25 / 1 x T30 / 1 x T40	
	1 x Bit holder magnetic 58 mm 1/4"	
	1 x Belt clip	
	1 x FlipSelector	

## Pozidriv, TORX® 14-pcs. 1/4" C6,3





7947905

Order-No.		
39041		10
	1 x PZ1 / 2 x PZ2 / 1 x PZ3	
	1 x T10 / 1 x T15 / 2 x T20 / 2 x T25 / 1 x T30 / 1 x T40	
	1 x Bit holder magnetic 58 mm 1/4"	
	1 x FlipSelector	





**TORX®, 15-pcs., 1/4" C6,3 with belt clip** SB7947505

Order-No.		
39056	x	5
	1 x T7 / 1 x T8 / 1 x T9 / 1 x T10 / 2 x T15 / 2 x T20 / 2 x T25 / 1 x T30 / 1 x T40	
	1 x Bit holder magnetic 58 mm 1/4"	
	1 x FlipSelector	
	1 x Belt clip	

**TORX® Tamper Resistant (with drill hole), 15-pcs., 1/4" C6,3 with belt clip** SB7947505TR

Order-No.		
39057	x	5
	1 x T7H / 1 x T8H / 1 x T9H / 1 x T10H / 2 x T15H / 2 x T20H / 2 x T25H / 1 x T30H / 1 x T40H	
	1 x Bit holder magnetic 58 mm 1/4"	
	1 x FlipSelector	
	1 x Belt clip	

**Hex, 15-pcs., 1/4" C6,3 with belt clip** SB7947902



Order-No.		
39059	x	5
	1 x 1.5 mm / 1 x 2.0 mm / 1 x 2.5 mm / 2 x 3.0 mm / 2 x 4.0 mm / 1 x 5.0 mm / 1 x 6.0 mm / 1 x 8.0 mm	
	1 x Bit holder magnetic 58 mm 1/4"	
	1 x Belt clip	
	1 x FlipSelector	

**Bit set FlipSelector Standard 25 mm**



**Meets your requirements:** Robust and precise bits for general fastening in trade and industry. **Saves time:** Simple and quick recognition of profile sizes thanks to contrasting laser marking.

**SIT (for Assy® and Pias screws), 14-pcs., 1/4" C6,3** 7947995





Order-No.	
39045	10
	2 x SIT 10 / 4 x SIT 20 / 3 x SIT 25 / 2 x SIT 30 / 1 x SIT 40
	1 x Bit holder magnetic 58 mm 1/4"
	1 x FlipSelector

**High-performance offset screwdriver with quick release holder 1/4"**



**Increases your efficiency:** Unlimited access to hard-to-reach screws thanks to the 105°-angled tool head. **Increases your safety:** Variably settable stabiliser arm.

**1/4" in blister pack** 24628





Order-No.						
32310	1/4"	1/4"	165	57.0	x	1

**Bit holder CentroFix mechanically lockable**



**Simplifies your work:** Ideal for all applications due to the non-magnetic locking mechanism. **Increases your efficiency:** Extremely secure and tight zero-play hold of bits.

**1/4" in box** 7148



Order-No.					
32477	1/4"	1/4"	60	x	10

**Bit holder CentroFix Super Slim mechanically lockable**



**Increases your efficiency:** Unlimited access to deep-set screws thanks to extreme slimline design. **Saves time:** Automatic bit locking mechanism upon insertion.

**1/4" in box** 7148CS





Order-No.					
39134	1/4"	1/4"	66	x	10

**Bit holder magnetic, clamping with retaining ring**



**Simplifies your work:** Unrestricted access to low-lying screws thanks to bit holder lengths of up to 250mm. **Increases your efficiency:** Unlimited access to deep-set screws thanks to extreme slimline design.

**1/4"** 7143

Order-No.				
01913	1/4"	1/4"	72	2
36092	1/4"	1/4"	100	5
34306	1/4"	1/4"	150	5
36093	1/4"	1/4"	200	5
36094	1/4"	1/4"	250	5

Fastening / Jamming





## Bit Professional



**Meets your requirements:** Robust and precise bits for general fastening in trade and industry. **Increases your efficiency:** Best rotation characteristics for stable fastening processes. **Saves time:** Simple and quick recognition of profile sizes thanks to contrasting laser marking.



## Slotted 1/4" E6,3

7040ZL

Order-No.				
33961	2.5	70	0.4	5
01790	3.0	50	0.5	5
33962	3.0	70	0.5	5
01792	3.5	50	0.6	5
33963	3.5	70	0.6	5
01791	4.0	50	0.5	5
01794	4.0	50	0.8	5
33964	4.0	70	0.8	5
01793	4.5	50	0.6	5
01795	5.5	50	0.8	5
01796	5.5	50	1.0	5
33965	5.5	70	1.0	5
01798	6.5	50	1.2	5
33966	6.5	70	1.2	5
01799	8.0	50	1.2	5
01800	8.0	50	1.6	5



## Phillips 1/4" E6,3

7041Z

Order-No.			
31960	PH00	50	5
31961	PH00	70	5
31962	PH00	90	5
32105	PH0	50	5
35456	PH0	70	5
35457	PH0	90	5
33703	PH1	50	5
01803	PH1	70	5
04126	PH1	90	5
23213	PH1	110	5
23219	PH1	127	5
22509	PH1	150	5
33704	PH2	50	5
01805	PH2	70	5
04009	PH2	90	5
05800	PH2	110	5
06888	PH2	127	5
22510	PH2	150	5
33705	PH3	50	5
04010	PH3	70	5
04127	PH3	90	5
23215	PH3	110	5
23217	PH3	127	5
22511	PH3	150	5



## Pozidriv 1/4" E6,3

7042Z

Order-No.			
31957	PZ0	50	5
31958	PZ0	70	5
31959	PZ0	90	5
33706	PZ1	50	5
01808	PZ1	70	5
01809	PZ1	90	5
23221	PZ1	110	5
23225	PZ1	127	5
23227	PZ1	150	5
33707	PZ2	50	5
01811	PZ2	70	5
01812	PZ2	90	5
05799	PZ2	110	5
06889	PZ2	127	5
23228	PZ2	150	5
33708	PZ3	50	5
04059	PZ3	70	5
04176	PZ3	90	5
23223	PZ3	110	5
23226	PZ3	127	5
22512	PZ3	150	5



## PlusMinus/Phillips 1/4" E6,3

7049PHM

Order-No.			
32490	SL/PH1	50	5
32491	SL/PH1	70	5
32686	SL/PH1	90	5
32492	SL/PH2	50	5
32493	SL/PH2	70	5
32687	SL/PH2	90	5



## PlusMinus/Pozidriv 1/4" E6,3

7049PZM

Order-No.			
32494	SL/PZ1	50	5
32495	SL/PZ1	70	5
32688	SL/PZ1	90	5
32496	SL/PZ2	50	5
32497	SL/PZ2	70	5
32689	SL/PZ2	90	5



**TORX® ball end 1/4" E6,3**

7045BE

Order-No.			
32410	T10	50	5
32416	T10	70	5
32417	T15	50	5
32418	T15	70	5
32411	T20	50	5
32419	T20	70	5
32412	T25	50	5
32421	T25	70	5
32413	T27	50	5
32414	T30	50	5
32423	T30	70	5
32415	T40	50	5



**TORX® MagicSpring® 1/4" E6,3**

7045R

Order-No.			
34452	T10	50	5
34453	T15	50	5
34454	T20	50	5
34455	T25	50	5
34456	T30	50	5
34457	T40	50	5



**TORX® Tamper Resistant (with hole) 1/4" E6,3**

7045ZH

Order-No.			
21045	T7H	50	5
21047	T8H	50	5
20218	T9H	50	5
20219	T10H	50	5
39188	T10H	90	5
24867	T15H	50	5
39189	T15H	90	5
20220	T20H	50	5
39190	T20H	90	5
20221	T25H	50	5
39191	T25H	90	5
20222	T27H	50	5
39192	T27H	90	5
20223	T30H	50	5
39193	T30H	90	5
20224	T40H	50	5
39194	T40H	90	5



**TORX® 1/4" E6,3**

7045Z

Order-No.			
39184	T1	50	5
39185	T2	50	5
39186	T3	50	5
39187	T4	50	5
32299	T5	50	5
32302	T6	50	5
33709	T6	70	5
33717	T6	90	5
38370	T6	150	5
32303	T7	50	5
33710	T7	70	5
33718	T7	90	5
38371	T7	150	5
32304	T8	50	5
33711	T8	70	5
33719	T8	90	5
36327	T8	150	5
32305	T9	50	5
33712	T9	70	5
33720	T9	90	5
38372	T9	150	5
32306	T10	50	5
33713	T10	70	5
33721	T10	90	5
33725	T10	110	5
33726	T10	150	5
32307	T15	50	5
33714	T15	70	5
33722	T15	90	5
33727	T15	110	5
33728	T15	150	5
32308	T20	50	5
33715	T20	70	5
33723	T20	90	5
33729	T20	110	5
33730	T20	150	5
32309	T25	50	5
33716	T25	70	5
33724	T25	90	5
33731	T25	110	5
33732	T25	150	5
33920	T27	50	5
33921	T27	70	5
33922	T27	90	5
33923	T30	50	5
33924	T30	70	5
33925	T30	90	5
33926	T30	110	5
33927	T30	150	5
33928	T40	50	5
33929	T40	70	5
33930	T40	90	5
33931	T40	110	5
33932	T40	150	5



**TORX PLUS® 1/4" E6,3**

7046Z

Order-No.			
28481	5IP	50	5
26000	6IP	50	5
26002	7IP	50	5
23195	8IP	50	5
23197	9IP	50	5
23199	10IP	50	5
23201	15IP	50	5
23203	20IP	50	5
23205	25IP	50	5
23207	27IP	50	5
23209	30IP	50	5
23211	40IP	50	5



**Torq-Set® 1/4" E6,3**

7049ZOTTS

Order-No.			
22596	4	50	5
22597	5	50	5
22598	6	50	5
22599	8	50	5
22600	10	50	5



**Hexagonal ball end MagicRing® 1/4" E6,3**

7047ZR

Order-No.			
25739	3.0	50	5
25740	4.0	50	5
25741	5.0	50	5
25742	6.0	50	5



**MagicRing® hex 1/4" E6,3**

7043ZR

Order-No.			
23145	3.0	50	5
23147	4.0	50	5
23149	5.0	50	5
23151	6.0	50	5





**Hexagon 1/4" E6,3**

7043Z

Order-No.			
05301	1.5	50	5
05302	2.0	50	5
34554	2.0	70	5
39178	2.0	90	5
05303	2.5	50	5
34555	2.5	70	5
39179	2.5	90	5
04194	3.0	50	5
34556	3.0	70	5
39180	3.0	90	5
04195	4.0	50	5
34557	4.0	70	5
39181	4.0	90	5
04196	5.0	50	5
34558	5.0	70	5
39182	5.0	90	5
04197	6.0	50	5
34559	6.0	70	5
39183	6.0	90	5
04198	8.0	50	5
34560	8.0	70	5

**Internal square 1/4" E6,3**

7048Z

Order-No.				
06637	#1	2.3	50	5
39208	#3	3.3	90	5
39206	#1	2.3	90	5
06638	#2	2.8	50	5
39207	#2	2.8	90	5
06639	#3	3.3	50	5



Fastening / jamming



Perfect order when fast work is required.



Perfect order and easy handling - the ErgoStar L-key holder provides both: Rotating a single L-key in the holder means that all other keys rotate at the same angle! Keys sitting next to each other no longer need to be disentangled. Instead, all keys are ready for removal with one turn - as fast and easy as never before. The keys of the ErgoStar also help to make work significantly easier: The Wiha L-key set, made of fully hardened chrome vanadium steel, includes an innovation that will convince everyone. A spring steel ring holds hexagon screws reliably.

- **Simplifies your work**

The ball end facilitates access to screws and allows you to work at an angle of up to 25°.

- **Increases your efficiency**

Wiha MagicRing® retaining function holds all screws firmly in place – without any magnets.

- **Makes handling easier**

Always the correct key when you need it.

- **Saves time**

Ensures order: removing and targeted insertion in the holder is child's play.

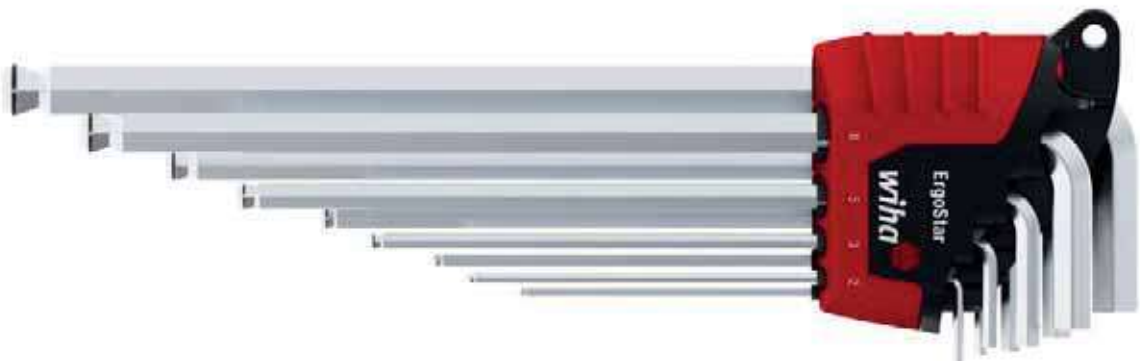

reddot design award  
winner 2010



Focus Open  
Silber 2011



## L-key set in ErgoStar holder

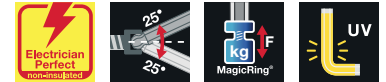
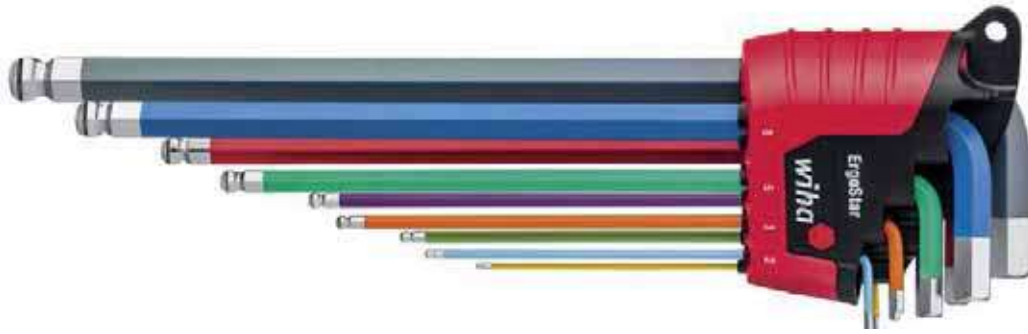

**Simplifies your work:** The ball end facilitates access to screws and allows you to work at an angle of up to 25°. **Lowers your costs:** Reduces the risk of forgetting and leaving keys inside a machine and causing damage. **Makes handling easier:** Always the right key in the right place with the ErgoStar holder. **Saves time:** Ensures order: removal and targeted insertion in the holder is child's play. **Increases your efficiency:** The colored L-keys are quick and easy to find. Thanks to their luminescent paint, they can even be retrieved in the dark with the Wiha flashlight with UV light function. This means it takes less time to find lost L-keys, while the risk of machine damage due to tools left inside machines is minimized. The hexagonal ball end of the L-keys enables users to fasten and unfasten effortlessly at an angle of up to 25°. **Increases your efficiency:** The required key width can be quickly found thanks to colour coding. **Increases your efficiency:** Wiha MagicRing® holding feature holds all hex screws in place without a magnet.



Focus Open 2021  
Silver

## hexagonal ball Magicring® 10-pcs. in fluorescent colour in blister pack

SB369RE9F01

Order-No.		
43850	x	5
ErgoStar holder		
● 1.5 mm / 2.0 mm / 2.5 mm / 3.0 mm / 4.0 mm / 5.0 mm / 6.0 mm / 8.0 mm / 10.0 mm		

### INFOBOX: Tools in fluorescent colour



- Coloured bits and ErgoStar with coloured L-keys light up under a UV light.
- Ensuring misplaced tools are quickly and easily found again.
- The Wiha flashlight with a UV light makes the perfect complement to coloured fluorescent tools.



### INFOBOX: ErgoStar



#### The right L-key after just one turn.

- One turn of any L-key and all L-keys are ready for removal.
- Solid stopping point for fixing L-keys in the holder.
- Innovative clamping ensures L-keys are held firmly in both a closed and open position.
- Compact design saves space on the work bench or in the toolbox.



L-key set in ErgoStar holder



Fastening / jamming

**Simplifies your work:** The ball end facilitates access to screws and allows you to work at an angle of up to 25°. **Makes handling easier:** Always the correct key when you need it. **Saves time:** Ensures order: removal and targeted insertion in the holder is child's play. **Increases your efficiency:** Wiha MagicRing® holding feature holds all hex screws in place without a magnet. **Lowers your costs:** Highly durable thanks to high-quality, chrome-plated L-key surface to prevent corrosion.

Hexagonal ball end MagicRing®, 10-pcs., matt chrome-plated in blister pack

SB369RH901

Order-No.		
43851	x	5
	1 x 1.5 mm / 1 x 2.0 mm / 1 x 2.5 mm / 1 x 3.0 mm / 1 x 4.0 mm / 1 x 5.0 mm / 1 x 6.0 mm / 1 x 8.0 mm / 1 x 10.0 mm	
	1 x ErgoStar holder	

MagicRing® from size 3 mm.  
Based on ISO 2936L.

INFOBOX:  
MagicRing®

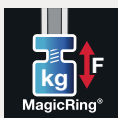

Wiha MagicRing®

- Spring steel ring reliably holds hex screws in place
- An innovation, which will benefit each user.

INFOBOX:  
Ball end hex

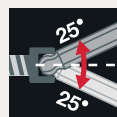

Wiha hexagonal ball end

- The ball end can be rotated by up to 25° in both clockwise and anti-clockwise direction.

L-key set in Compact holder



**Saves space:** All standard keys organised in a compact, space-saving design. **Simplifies your work:** The ball end facilitates access to screws and allows you to work at an angle of up to 25°. **Lowers your costs:** Highly durable thanks to high-quality, chrome-plated L-key surface to prevent corrosion.

**Hexagonal ball end, 10-pcs., matt chrome-plated** SB369H9

Order-No.		
02292	x	5
	1 x 1.5 mm / 1 x 2.0 mm / 1 x 2.5 mm / 1 x 3.0 mm / 1 x 4.0 mm / 1 x 5.0 mm / 1 x 6.0 mm / 1 x 8.0 mm / 1 x 10.0 mm	
	1 x Compact holder	

Based on ISO 2936L.

L-key set in ErgoStar holder



**Simplifies your work:** The ball end facilitates access to screws and allows you to work at an angle of up to 25°. **Makes handling easier:** Always the correct key when you need it. **Saves time:** Ensures order: removal and targeted insertion in the holder is child's play.

**TORX® ball end, 14-pcs., black oxidised** SB366BEHZ1301

Order-No.		
43847	x	5
	1 x T5 / 1 x T6 / 1 x T7 / 1 x T8 / 1 x T9 / 1 x T10 / 1 x T15 / 1 x T20 / 1 x T25 / 1 x T27 / 1 x T30 / 1 x T40 / 1 x T45	
	1 x ErgoStar holder	

TORX® ball end starting from size T9

INFOBOX:  
**TORX® ball end**

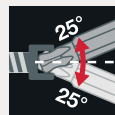

**Wiha TORX® ball end**

- With optimised TORX® ball end geometry
- Increased strength thanks to the special cold forming on a system developed by Wiha especially for this purpose.
- Allows fastening and unfastening at angles up to 25°.
- Simple insertion of the tool/bit and fastening/ unfastening, especially in hard-to-reach positions.
- Broad product range: As an L-key, as a bit and as a SoftFinish® screwdriver.



## L-key set in ErgoStar holder



**Makes handling easier:** Always the correct key when you need it.  
**Saves time:** Ensures order: removal and targeted insertion in the holder is child's play. **Increases your efficiency:** Wiha MagicSpring® holding feature holds all Torx® screws in place without a magnet.

**TORX® MagicSpring®, 14-pcs. in blister pack, black oxidised**

SB366RHZ1301

Order-No.		
43848	x	5
	1 x T5 / 1 x T6 / 1 x T7 / 1 x T8 / 1 x T9 / 1 x T10 / 1 x T15 / 1 x T20 / 1 x T25 / 1 x T27 / 1 x T30 / 1 x T40 / 1 x T45	
	1 x ErgoStar holder	

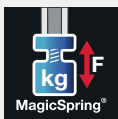
**INFOBOX:  
 MagicSpring®**

**Wiha TORX® MagicSpring®**

- TORX® and TORX PLUS® screws are held securely in place.
- An innovation, which will benefit each user.

# Tight fastening – easy opening.



Tightening and installation work requires many different profiles. Wiha precisely offers the required equipment and presents every user with a wide range of tools. The various nut driver and bit sets, as well as ring ratchet open-ended spanner sets, fastenings of all types can be easily tightened and opened. The extensive equipment range extends from a SoftFinish® screwdriver, various bits and bit holders, up to ratchet wrenches, extensions, and universal joints. The range is complemented by various ring ratchet open spanners. When it comes to flexibility and efficiency, the ratchet wrenches from Wiha are particularly distinguished by a variably selectable rotational direction as well as fine gearing with 72 gear teeth.

- **Increases your efficiency**  
Fastening without interruption thanks to a finely toothed ratchet wrench.
- **Increases your flexibility**  
Variably adjustable right or left rotation through switching lever.
- **Meets your requirements**  
Precise fitting, robust, and easy to clean.
- **Increases your efficiency**  
All main tools quickly available, always at hand.



## Nut driver and bit set 1/4" and 1/2"



**Increases your flexibility:** Variably adjustable right or left rotation through switching lever. **Increases your efficiency:** Fastening without interruption thanks to a finely toothed ratchet wrench. **Simplifies your work:** All tools securely arranged in a robust and clearly laid out L Boxx. **Increases your efficiency:** The combination of all standard nut driver sizes and various bits in a sorting system based on the L Boxx, accommodates all work activities and easy mobility. **Meets your requirements:** Precise fitting, robust, and easy to clean.

60 pcs. incl. L Boxx

33397

Order-No.



44685

1

- Ratchet wrench for nut drivers 1/4" switchable 1/4" x 128 mm (44666) / 1/2" x 257 mm (44709)
- Nut driver insert 1/4" hexagon head 4.0 mm (44669) / 5.0 mm (44670) / 5.5 mm (44671) / 6.0 mm (44672) / 7.0 mm (44673) / 8.0 mm (44674) / 9.0 mm (44675) / 10.0 mm (44676) / 11.0 mm (44678) / 12.0 mm (44679) / 13.0 mm (44680) / 14.0 mm (44681)
- Nut driver insert 1/2" double hex 10.0 mm (44715) / 11.0 mm (44716) / 12.0 mm (44717) / 13.0 mm (44718) / 14.0 mm (44719) / 15.0 mm (44720) / 16.0 mm (44721) / 17.0 mm (44722) / 18.0 mm (44723) / 19.0 mm (44724) / 21.0 mm (44726) / 22.0 mm (44727) / 24.0 mm (44729) / 27.0 mm (44732) / 30.0 mm (44735) / 32.0 mm (44737) / 34.0 mm (44738)
- Extension 1/4" for nut driver inserts 75 mm (44667) / 150 mm (44668)
- Extension 1/2" for nut driver inserts 150 mm (44711) / 250 mm (44712)
- Universal joint with ball Internal square, square head 1/4" (44682) / 1/2" (44739)
- Screwdriver with bit holder SoftFinish® magnetic 1/4" 112 mm (32160)
- Bit holder CentroFix Force mechanically lockable 1/4", magnetic in box 60 mm (39133)
- Bit Standard 25 mm Slotted 1/4" C6,3 4.5 mm (01623) / 5.5 mm (01624) / 6.5 mm (01626)
- Bit Standard 25 mm Phillips 1/4" C6,3 PH1 (01657) / PH2 (01658)
- Bit Standard 25 mm Pozidriv 1/4" C6,3 PZ1 (01688) / PZ2 (01689) / PZ3 (01690)
- Bit Standard 25 mm TORX® 1/4" C6,3 T10 (01716) / T15 (01717) / T20 (01718) / T25 (01719) / T27 (01720) / T30 (01721) / T40 (01722)
- Bit Standard 25 mm Hexagon 1/4" C6,3 3.0 mm (01705) / 4.0 mm (01706) / 5.0 mm (01707) / 6.0 mm (01708)
- Tool shaft with ball Square, Internal hexagon 1/4" C6,3 (01933)

L-BOXX

Based on DIN 3124

## Nut driver and bit set 1/4"



1/4"

**Increases your flexibility:** Variably adjustable right or left rotation through switching lever. **Increases your efficiency:** Fastening without interruption thanks to a finely toothed ratchet wrench. **Simplifies your work:** All tools securely arranged in a robust, orderly bag. **Makes handling easier:** Simple to hook on to work trousers thanks to the high quality clip holder. **Increases your efficiency:** All main tools quickly available, always at hand. **Meets your requirements:** Precise fitting, robust, and easy to clean.



## 40 pcs. incl. multifunctional bag with belt clip

33394

Order-No.



44684

1

- Ratchet wrench for nut drivers 1/4" switchable 128 mm (44666)
- Nut driver insert 1/4" hexagon head 4.0 mm (44669) / 4.5 mm (44677) / 5.0 mm (44670) / 5.5 mm (44671) / 6.0 mm (44672) / 7.0 mm (44673) / 8.0 mm (44674) / 9.0 mm (44675) / 10.0 mm (44676) / 11.0 mm (44678) / 12.0 mm (44679) / 13.0 mm (44680) / 14.0 mm (44681)
- Extension 1/4" for nut driver inserts 75 mm (44667) / 150 mm (44668)
- Universal joint with ball Internal square, square head 1/4" (44682)
- Screwdriver with bit holder SoftFinish® magnetic 1/4" 112 mm (32160)
- Bit holder CentroFix Force mechanically lockable 1/4", magnetic in box 60 mm (39133)
- Bit Standard 25 mm Slotted 1/4" C6,3 4.5 mm (01623) / 5.5 mm (01624) / 6.5 mm (01626)
- Bit Standard 25 mm Phillips 1/4" C6,3 PH1 (01657) / PH2 (01658)
- Bit Standard 25 mm Pozidriv 1/4" C6,3 PZ1 (01688) / PZ2 (01689) / PZ3 (01690)
- Bit Standard 25 mm TORX® 1/4" C6,3 T10 (01716) / T15 (01717) / T20 (01718) / T25 (01719) / T27 (01720) / T30 (01721) / T40 (01722)
- Bit Standard 25 mm Hexagon 1/4" C6,3 3.0 mm (01705) / 4.0 mm (01706) / 5.0 mm (01707) / 6.0 mm (01708)
- Tool shaft with ball Square, Internal hexagon 1/4" C6,3 (01933)
- Tool Belt Pouch

Based on DIN 3124

Ring ratchet open-ended spanner set



**Increases your efficiency:** Fastening without interruption thanks to a finely toothed ring ratchet. **Increases your flexibility:** Variably adjustable right or left rotation through switching lever. **Simplifies your work:** With a convenient holder for clearly arranged storage and easy withdrawal. **Increases your efficiency:** Improved accessibility in confined spaces thanks to 15° jaw positioning and double hex ring ratchet.

13 pcs. switchable, with holder

303190

Order-No.



44661

1

Ring ratchet open-end spanner Switchable 8 mm x 8 mm (44641) / 9 mm x 9 mm (44642) / 10 mm x 10 mm (44644) / 11 mm x 11 mm (44645) / 12 mm x 12 mm (44646) / 13 mm x 13 mm (44647) / 14 mm x 14 mm (44648) / 15 mm x 15 mm (44789) / 16 mm x 16 mm (44649) / 17 mm x 17 mm (44650) / 18 mm x 18 mm (44651) / 19 mm x 19 mm (44652)

holder

Based on DIN 3124

Ring ratchet open-ended spanner set



**Increases your efficiency:** Fastening without interruption thanks to a finely toothed ring ratchet. **Simplifies your work:** With a convenient holder for clearly arranged storage and easy withdrawal. **Increases your efficiency:** Improved accessibility in confined spaces thanks to 15° jaw positioning and double hex ring ratchet.

13 pcs. with holder

30391

Order-No.



44665

1

Ring ratchet open-end spanner 8 mm x 8 mm (44638) / 9 mm x 9 mm (44639) / 10 mm x 10 mm (44640) / 11 mm x 11 mm (44643) / 12 mm x 12 mm (44653) / 13 mm x 13 mm (44654) / 14 mm x 14 mm (44655) / 15 mm x 15 mm (44656) / 16 mm x 16 mm (44657) / 17 mm x 17 mm (44658) / 18 mm x 18 mm (44659) / 19 mm x 19 mm (44660)

holder

Based on DIN 3124

Double open-end spanner set



**Simplifies your work:** With a convenient holder for clearly arranged storage and easy withdrawal. **Increases your efficiency:** Improved accessibility in confined spaces thanks to 15° jaw positioning.

13 pcs. with holder

37390

Order-No.



44753

1

Double open-end spanner set 6 mm x 7 mm (44741) / 8 mm x 9 mm (44742) / 10 mm x 11 mm (44743) / 12 mm x 13 mm (44744) / 14 mm x 15 mm (44745) / 16 mm x 17 mm (44746) / 18 mm x 19 mm (44747) / 20 mm x 22 mm (44748) / 21 mm x 23 mm (44749) / 24 mm x 27 mm (44750) / 25 mm x 28 mm (44849) / 30 mm x 32 mm (44752)

holder

Based on DIN 3124

Ring ratchet open-ended spanner set



**Increases your efficiency:** Fastening without interruption thanks to a finely toothed ratchet wrench. **Simplifies your work:** With a convenient holder for clearly arranged storage and easy withdrawal. **Increases your efficiency:** Improved accessibility in confined spaces thanks to 15° jaw positioning and double hex ring ratchet.

8 pcs. with holder

30396

Order-No.



45244

1

8 mm x 8 mm / 10 mm x 10 mm / 12 mm x 12 mm / 13 mm x 13 mm / 15 mm x 15 mm / 17 mm x 17 mm / 19 mm x 19 mm

Based on DIN 3124

## Ring ratchet open-ended spanner set



**Increases your efficiency:** Fastening without interruption thanks to a finely toothed ring ratchet. **Simplifies your work:** With a convenient holder for clearly arranged storage and easy withdrawal. **Increases your efficiency:** Improved accessibility in confined spaces thanks to 15° jaw positioning and double hex ring ratchet.

**8 pcs. with holder**

30390

Order-No.



44664

1

9 mm x 9 mm / 10 mm x 10 mm / 11 mm x 11 mm /  
12 mm x 12 mm / 13 mm x 13 mm / 14 mm x 14 mm /  
15 mm x 15 mm

holder

Based on DIN 3124



Fastening / Jamming



**Protect your health**

Special DynamicJoint® design reduces effort required for cutting.

**Protect your health**

Wiha pliers are kind to the muscles and ergonomic to work with, permanently reducing wrist strain.

**Offers you full protection**

Each tool individually tested at 10,000 V AC and approved for 1,000 V AC.

# Trimming / cutting

## A cut above the rest with Wiha.

A precise cut at the right time – no problem for Wiha diagonal cutters, heavy-duty diagonal cutters, cable cutters, cable shears and combination pliers. With the perfect combination of high-quality materials and ergonomic comfort, Wiha VDE-tools withstand the toughest demands. Production is in accordance to the state-of-the-art quality management guidelines. A special heat treatment and inductive hardening of the parts under high stress ensure a long lifespan. The precise interaction of the joints and the exacting quality workmanship of the blades and gripping surfaces ensure the highest level of functionality. All Wiha products have been designed according to the latest findings in ergonomics. Ergonomic handles and well thought-out soft and hard zone distribution makes for work that protects the hands from strain and is comfortable.

**"With BiCut<sup>®</sup>, I always have sufficient power when cutting - and without aching fingers."**

Timo Schweitzer



**Double your power at the push of a button.**



Precise and safe work – at double the power: no problem for the Wiha BiCut® Professional electric diagonal cutters. If there is not enough power when cutting, or if cutting is laborious, a simple push of a button is all that is required and the cutting power is doubled. Another push of the button, and the power is halved again – easy! This significantly reduces the risk of cramp or slippage when applying too much force. The extra-wide back for the handle, with perfectly distributed soft and hard zones, ensures the optimum ergonomics. The new Wiha BiCut® has already been awarded with the “reddot award 2014winner” for outstanding design quality.

- **Increases your efficiency**  
Two pliers in one - 200 % power at the touch of a button, available at any time.
- **Protect your health**  
Requires less force and reduces pressure on the wrists.
- **Offers you full protection**  
Each tool individually tested at 10,000 V AC and approved for 1,000 V AC.



Professional BiCut® high-performance diagonal cutters with DynamicJoint®



**Increases your efficiency:** Two pliers in one - 200 % power at the touch of a button, available at any time. **Protects your health:** Requires less force and reduces pressure on the wrists. **Lowers your costs:** Durable thanks to high-quality, chrome-plated plier surface to prevent corrosion. **Offers you full protection:** Each tool individually tested at 10,000 V AC and approved for 1,000 V AC.



reddot award 2014  
winner

Switchable

Z 18 0 06

Order-No.					
38191	200	8"	21	3	5

Manufactured acc. to IEC 60900.

INFOBOX:  
Safety note



- Wees bij het werken met kniptangen alert op wegspringende draadeinden. Draag een veiligheidsbril.

INFOBOX:  
BiCut®

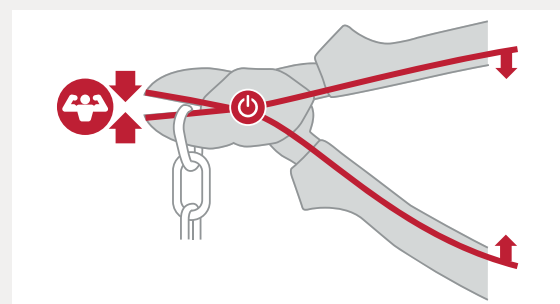
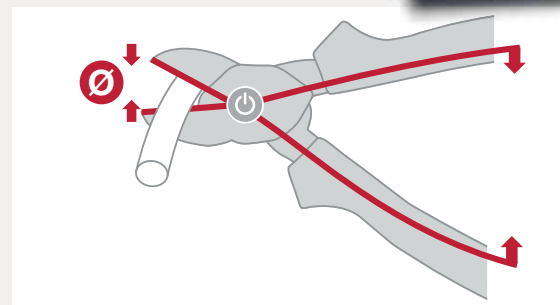

INFOBOX:  
Cutting capacity info



	Example
1 - 5	copper, aluminium
6 - 10	Iron nails
11 - 15	Screws
16 - 21	Hardened spring steel

Installation pliers TriCut Professional electric



**Simplifies your work:** The angled head allows you to work in hard-to-reach places such as installation sockets. **Lowers your costs:** Durable thanks to high-quality, chrome-plated plier surface to prevent corrosion. **Saves money:** Now you only need one tool for three tasks: cutting to length, stripping and skinning. **Increases your efficiency:** Three tools in one. Saves 60% volume and 50% less weight for 100% efficiency. **Offers you full protection:** Each tool individually tested at 10,000 V AC and approved for 1,000 V AC.



Z 14 1 06

Order-No.	mm	7"	13	Ø mm	5
38552	170	7"	13	1.6	5

Manufactured acc. to IEC 60900.

INFOBOX:  
DynamicJoint®



**Wiha DynamicJoint® – A new dimension in strength and durability**

- Innovative: Optimised joint construction.
- Effective: Minimal power loss means less force needed for cutting.
- Permanent: Optimal performance even after thousands of cuts.

Trimming / cutting

Professional electric diagonal cutters with DynamicJoint®



**Protects your health:** Special DynamicJoint® design reduces effort required for cutting. **Lowers your costs:** Durable thanks to high-quality, chrome-plated plier surface to prevent corrosion. **Offers you full protection:** Each tool individually tested at 10,000 V AC and approved for 1,000 V AC.

Z 12 1 06

Order-No.	mm	in	mm	Ømm	mm
43326	140	5 1/2"	15	1.6	5
43335	160	6 1/2"	16	2	5
43340	180	7"	17	2.3	5

Manufactured acc. to IEC 60900.

Heavy-duty diagonal cutters Professional electric with Dynamic-Joint®

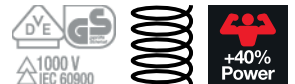

**Simplifies your work:** Up to 40% more cutting force thanks to optimised leverage. **Protects your health:** Special DynamicJoint® design reduces effort required for cutting. **Protects your health:** Reduces strain from continuous work thanks to opening spring. **Lowers your costs:** Durable thanks to high-quality, chrome-plated plier surface to prevent corrosion. **Offers you full protection:** Each tool individually tested at 10,000 V AC and approved for 1,000 V AC.

with switchable opening spring

Z 16 3 06

Order-No.	mm	in	mm	Ømm	mm
40921	160	6 1/2"	17	2	5
41274	180	7"	18	2.5	5
41279	200	8"	19	2.8	5

Manufactured acc. to IEC 60900.

Cable cutter Professional electric



**Lowers your costs:** Durable thanks to high-quality, chrome-plated plier surface to prevent corrosion. **Protects your health:** Reduces strain from continuous work thanks to opening spring. **Increases your efficiency:** Clean work thanks to cable cutting without crushing. **Offers you full protection:** Each tool individually tested at 10,000 V AC and approved for 1,000 V AC.

with switchable opening spring

Z 50 3 06

Order-No.	mm	in	mm	mm <sup>2</sup>	mm
43660	180	7"	4	50	5
43662	210	8 1/4"	5	60	5

Manufactured acc. to IEC 60900.

INFOBOX:  
Heavy-duty diagonal cutters



with switchable opening spring

- Up to 40% more cutting force thanks to optimised leverage.
- Opening spring with on/off function for fatigue-free work.
- Opening spring can be activated with just one hand.

Combination pliers Professional electric with DynamicJoint® and OptiGrip

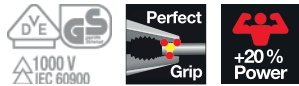

**Increases your efficiency:** A secure, non-slip grip in all standard work situations. **Protects your health:** Special DynamicJoint® design reduces effort required for cutting. **Lowers your costs:** Durable thanks to high-quality, chrome-plated plier surface to prevent corrosion. **Offers you full protection:** Each tool individually tested at 10,000 V AC and approved for 1,000 V AC.

with extra long cutting edge Z 01 0 06

Order-No.	mm	in	mm	Ømm	mm
26705	160	6 1/2"	15	1.6	5
26708	180	7"	16	1.8	5
26711	200	8"	17	2	5

Manufactured acc. to IEC 60900.

Needle nose pliers Professional electric



**Increases your efficiency:** Extra-long plier head for inserting low-lying components. **Lowers your costs:** Durable thanks to high-quality, chrome-plated plier surface to prevent corrosion. **Offers you full protection:** Each tool individually tested at 10,000 V AC and approved for 1,000 V AC.

with cutting edge straight shape Z 05 0 06

Order-No.	mm	in	mm	Ømm	mm
26720	160	6 1/2"	16	1.2	5
26727	200	8"	17	1.6	5

Manufactured acc. to IEC 60900.

Combination pliers Professional electric with DynamicJoint® and OptiGrip



**Simplifies your work:** Up to 40% more cutting force thanks to optimised leverage. **Increases your efficiency:** A secure, non-slip grip in all standard work situations. **Protects your health:** Special DynamicJoint® design reduces effort required for cutting. **Lowers your costs:** Durable thanks to high-quality, chrome-plated plier surface to prevent corrosion. **Offers you full protection:** Each tool individually tested at 10,000 V AC and approved for 1,000 V AC.

with extra long cutting edge Z 02 0 06

Order-No.	mm	in	mm	Ømm	mm
26714	200	8"	18	2.3	5
26717	225	9"	19	2.5	5

Manufactured acc. to IEC 60900.

Needle nose pliers Professional electric



**Increases your efficiency:** Extra-long plier head for inserting low-lying components. **Lowers your costs:** Durable thanks to high-quality, chrome-plated plier surface to prevent corrosion. **Offers you full protection:** Each tool individually tested at 10,000 V AC and approved for 1,000 V AC.

with cutting edge curved shape, approx. 40° Z 05 1 06

Order-No.	mm	in	mm	Ømm	mm
26728	160	6 1/2"	16	1.2	5
26729	200	8"	17	1.6	5

Manufactured acc. to IEC 60900.

Trimming / cutting

Precision mechanic's diagonal cutters Classic



**Meets your requirements:** For almost flush cutting of soft and semi-hard wires. **Protects your health:** Reduced risk of injury thanks to smooth burr-free finished results, for example with cable ties.

With opening spring

Z 44 3 01

Order-No.	mm	in	Scissors icon	Ø mm	Blade icon
36189	125	5"	7	0.8	5

Craftsman's cutters



**Simplifies your work:** Large blade notch and micro-toothed cutting edge prevent the cable from slipping out of the shears. **Increases your efficiency:** Shears for electricians with stripping, skinning, crimping & cutting-to-length functions in a single tool. **Makes handling easier:** The combination between a sturdy blade and an ergonomic handle with extra large handle holes enable users to make a flawless cut into cables up to 50 mm<sup>2</sup>. **Increases your safety:** Protective cover with retaining clip for safe carrying.

with crimp function in blister pack

Z 71 7 06

Order-No.	mm	mm <sup>2</sup>	Blade icon
41923	160	50	5

Plastic diagonal cutters Classic



**Meets your requirements:** For the smooth and flush cutting of plastics. **Protects your health:** Reduced risk of injury thanks to smooth burr-free finished results, for example with cable ties.

with opening spring without bevelled edge

Z 15 0 01

Order-No.	mm	in	Scissors icon	Blade icon
37402	125	5"	2	5
37403	160	6 1/2"	3	5

Hacksaw electric



**Increases your efficiency:** The fine-toothed saw blade allows a clean cut, for example on plastic pipes and metal cable ducts. **Makes handling easier:** Using the plastic screw, the saw blade can be changed quickly and easily. **Makes handling easier:** The ergonomic handle is suitable for both right- and left-handed users\* **Lowers your costs:** Durable and sturdy thanks to bimetallic saw blade. **Offers you full protection:** Each tool individually tested at 10,000 V AC and approved for 1,000 V AC.

insulated with three saw blades 150 mm

246176

Order-No.	mm	mm	Blade icon
43125	150	280	1



Trimming / cutting

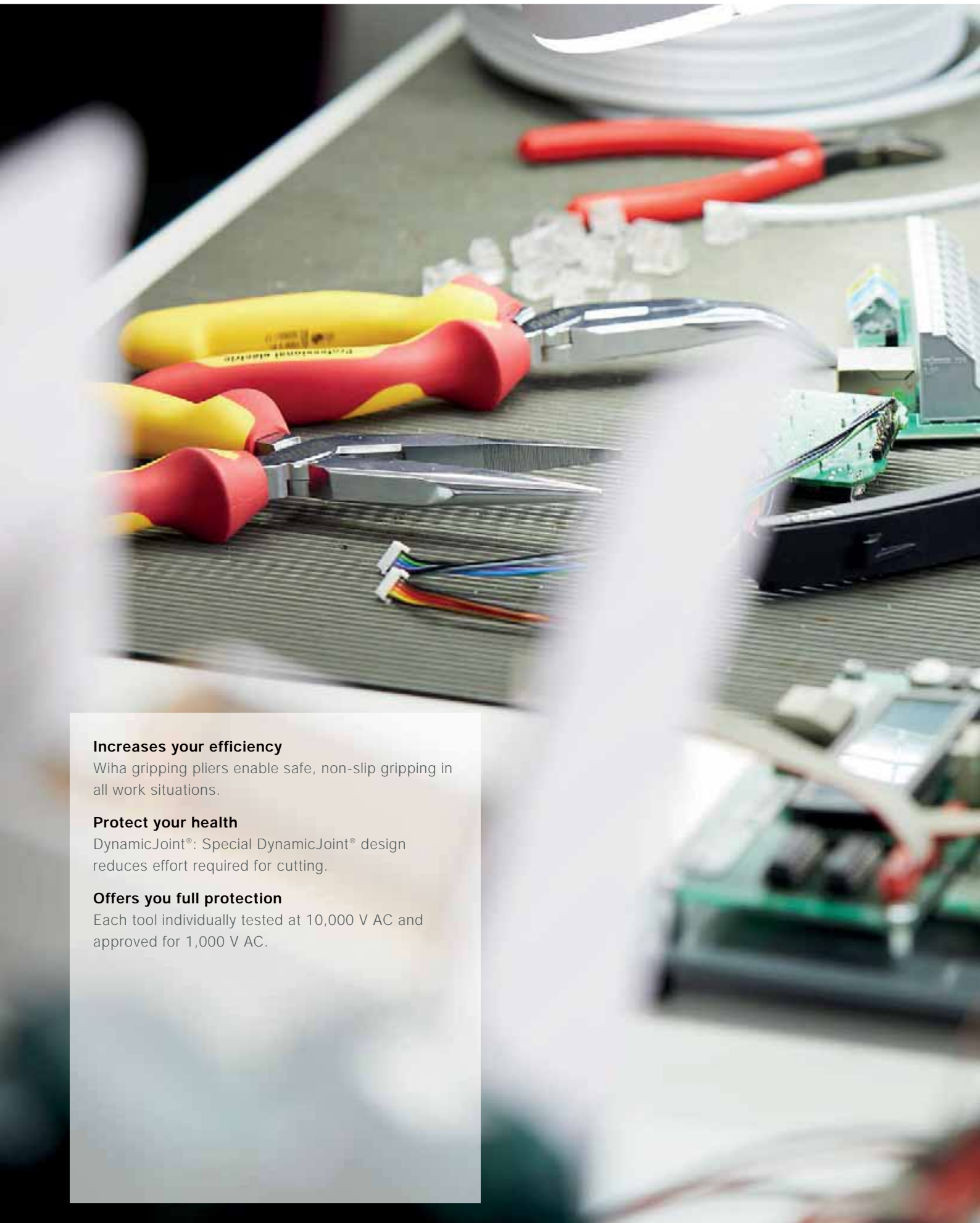

**Increases your efficiency**

Wiha gripping pliers enable safe, non-slip gripping in all work situations.

**Protect your health**

DynamicJoint®: Special DynamicJoint® design reduces effort required for cutting.

**Offers you full protection**

Each tool individually tested at 10,000 V AC and approved for 1,000 V AC.

# Supplying / holding

## Supplying – completely relaxed.

In the supplying and holding working procedures, Wiha pliers prove to be clever helpers for relaxed and efficient work. For instance, the OptiGrip of the combination and high-leverage combination pliers ensure optimal and secure holding using an innovative gripping surface: The unique 'triplepoint support' protects the work piece from twisting or slipping. The circlip pliers from the Classic Series with their MagicTips® precision tips made of high-performance steel offer considerable additional safety and stability. Their special latching function is especially useful against in preventing the circlips jumping off.

**“You only have to lose a circlip, and then you realize the benefits of Wiha pliers!”**

Frank Scheck



## Pliers set Professional electric

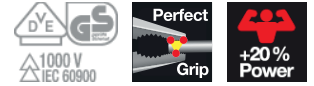

**Increases your efficiency:** Wiha needle nose pliers with extra-long plier head for inserting low-lying components. **Protects your health:** Special DynamicJoint® design reduces effort required for cutting. **Lowers your costs:** Durable thanks to high-quality, chrome-plated plier surface to prevent corrosion. **Offers you full protection:** Each tool individually tested at 10,000 V AC and approved for 1,000 V AC. **Increases your safety:** Wiha combination pliers enable safe, non-slip gripping in all work situations.

## Combination pliers, needle nose pliers, diagonal cutters 3-pcs.

Z99000106

Order-No.

26852



1

## Trimming / cutting

Professional electric diagonal cutters with DynamicJoint® 160 mm, 6 1/2" (43335)

## Supplying / holding

Combination pliers Professional electric with DynamicJoint® and OptiGrip with extra long cutting edge 180 mm, 7" (26708)

Needle nose pliers Professional electric with cutting edge straight shape 200 mm, 8" (26727)

Manufactured acc. to IEC 60900.

INFOBOX:  
DynamicJoint®

## Wiha DynamicJoint® – A new dimension in strength and durability

- Innovative: Optimised joint construction.
- Effective: Minimal power loss means less force needed for cutting.
- Permanent: Optimal performance even after thousands of cuts.

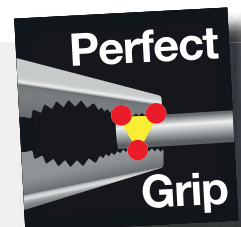
INFOBOX:  
OptiGrip

## Wiha OptiGrip – optimal grip due to newly designed gripping surfaces

- A firm hold: The „triple-point support“ protects the workpiece from twisting or slipping.
- Highly effective: Optimum grip even with large jaw opening – and at the same time significantly less force needed.
- A wide selection: Now in standard Wiha combination pliers and high leverage combination pliers.

Needle nose pliers Professional electric



**Increases your efficiency:** Extra-long plier head for inserting low-lying components. **Lowers your costs:** Durable thanks to high-quality, chrome-plated plier surface to prevent corrosion. **Offers you full protection:** Each tool individually tested at 10,000 V AC and approved for 1,000 V AC.

with cutting edge straight shape

Z 05 0 06

Order-No.	mm	in	mm	mm	SB	mm
26720	160	6 1/2"	16	1.2	-	5
26727	200	8"	17	1.6	-	5

Manufactured acc. to IEC 60900.

Needle nose pliers Professional electric



**Increases your efficiency:** Extra-long plier head for inserting low-lying components. **Lowers your costs:** Durable thanks to high-quality, chrome-plated plier surface to prevent corrosion. **Offers you full protection:** Each tool individually tested at 10,000 V AC and approved for 1,000 V AC.

with cutting edge curved shape, approx. 40°

Z 05 1 06

Order-No.	mm	in	mm	mm	SB	mm
26728	160	6 1/2"	16	1.2	-	5
26729	200	8"	17	1.6	-	5

Manufactured acc. to IEC 60900.

Combination pliers Professional electric with DynamicJoint® and OptiGrip

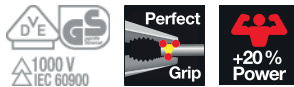

**Increases your efficiency:** A secure, non-slip grip in all standard work situations. **Protects your health:** Special DynamicJoint® design reduces effort required for cutting. **Lowers your costs:** Durable thanks to high-quality, chrome-plated plier surface to prevent corrosion. **Offers you full protection:** Each tool individually tested at 10,000 V AC and approved for 1,000 V AC.

with extra long cutting edge

Z 01 0 06

Order-No.	mm	in	mm	mm	SB	mm
26705	160	6 1/2"	15	1.6	-	5
26708	180	7"	16	1.8	-	5
26711	200	8"	17	2	-	5

Manufactured acc. to IEC 60900.

Combination pliers Professional electric with DynamicJoint® and OptiGrip

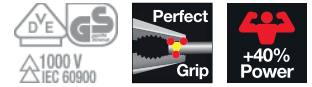

**Simplifies your work:** Up to 40% more cutting force thanks to optimised leverage. **Increases your efficiency:** A secure, non-slip grip in all standard work situations. **Protects your health:** Special DynamicJoint® design reduces effort required for cutting. **Lowers your costs:** Durable thanks to high-quality, chrome-plated plier surface to prevent corrosion. **Offers you full protection:** Each tool individually tested at 10,000 V AC and approved for 1,000 V AC.

with extra long cutting edge

Z 02 0 06

Order-No.	mm	in	mm	mm	SB	mm
26714	200	8"	18	2.3	-	5
26717	225	9"	19	2.5	-	5

Manufactured acc. to IEC 60900.

Long flat-nose pliers Professional electric



**Increases your efficiency:** Extra-long plier head for inserting low-lying components. **Offers you full protection:** Each tool individually tested at 10,000 V AC and approved for 1,000 V AC. **Increases your efficiency:** A secure, non-slip grip in all standard work situations.

Z 07 0 06

Order-No.	mm	in	SB	Icon
26732	160	6 1/2"	-	5

Manufactured acc. to IEC 60900.

Professional electric water pump pliers



**Meets your requirements:** Permanently stable through box joint with double guidance. **Lowers your costs:** Durable thanks to high-quality, chrome-plated plier surface to prevent corrosion. **Offers you full protection:** Each tool individually tested at 10,000 V AC and approved for 1,000 V AC.

box type

Z 21 0 06

Order-No.	mm	in	Icon	Icon	Icon
33520	250	10"	2"	50 mm	5

Long round-nose pliers Professional electric

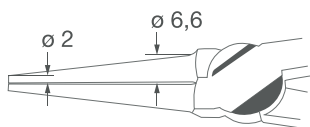

**Increases your efficiency:** Extra-long plier head for inserting low-lying components.

Z 09 0 06

Order-No.	mm	in	Icon
26735	160	6 1/2"	5

Manufactured acc. to IEC 60900.

Water pump pliers Professional electric



**Meets your requirements:** Permanently stable through box joint with double guidance. **Increases your efficiency:** Fast and simple adjustment of pliers with push button. **Lowers your costs:** Durable thanks to high-quality, chrome-plated plier surface to prevent corrosion. **Offers you full protection:** Each tool individually tested at 10,000 V AC and approved for 1,000 V AC.

with push button adjustment

Z 22 0 06

Order-No.	mm	in	Icon	Icon	Icon	Icon
37450	250	10"	2"	50	-	5

Manufactured acc. to IEC 60900.

## Pliers wrench Professional electric



**Simplifies your work:** Self-locking at AF 17 and above. **Simplifies your work:** Also suitable for left-handed users as operated without side push button. **Protects your health:** Compaction and bending tasks take minimum effort thanks to manual force increased tenfold. **Lowers your costs:** Minimises wear and prevents damage to sensitive surfaces thanks to smooth, parallel jaws and backlash-free handling. **Saves space:** Replaces a set of metric and imperial open-ended spanners. **Saves time:** Safe, rapid setting directly on the work piece with no need to press any buttons. **Saves time:** Ratchet function allows users to fasten screws instantly with a simple glide. **Improved access:** Slender design thanks to button-free setting enables it to be used in confined working environments, minimising the risk of damage. **Lowers your costs:** Durable thanks to high-quality, chrome-plated plier surface to prevent corrosion. **Offers you full protection:** Each tool individually tested at 10,000 V AC and approved for 1,000 V AC.

Z 25 0 06

Order-No.				
44314	250	10"	46 mm	5

Manufactured acc. to IEC 60900.

### INFOBOX: Plier wrench



- Required width setting directly on the work piece with no need to press any buttons
- Ratchet principle allows users to fasten screws rapidly with a simple glide.
- Thanks to its slim design and button-free setting, it is ideal for use in tight spaces.
- Smooth, parallel-acting jaws prevent damage on sensitive surfaces.

For those situations where a good grip is essential.

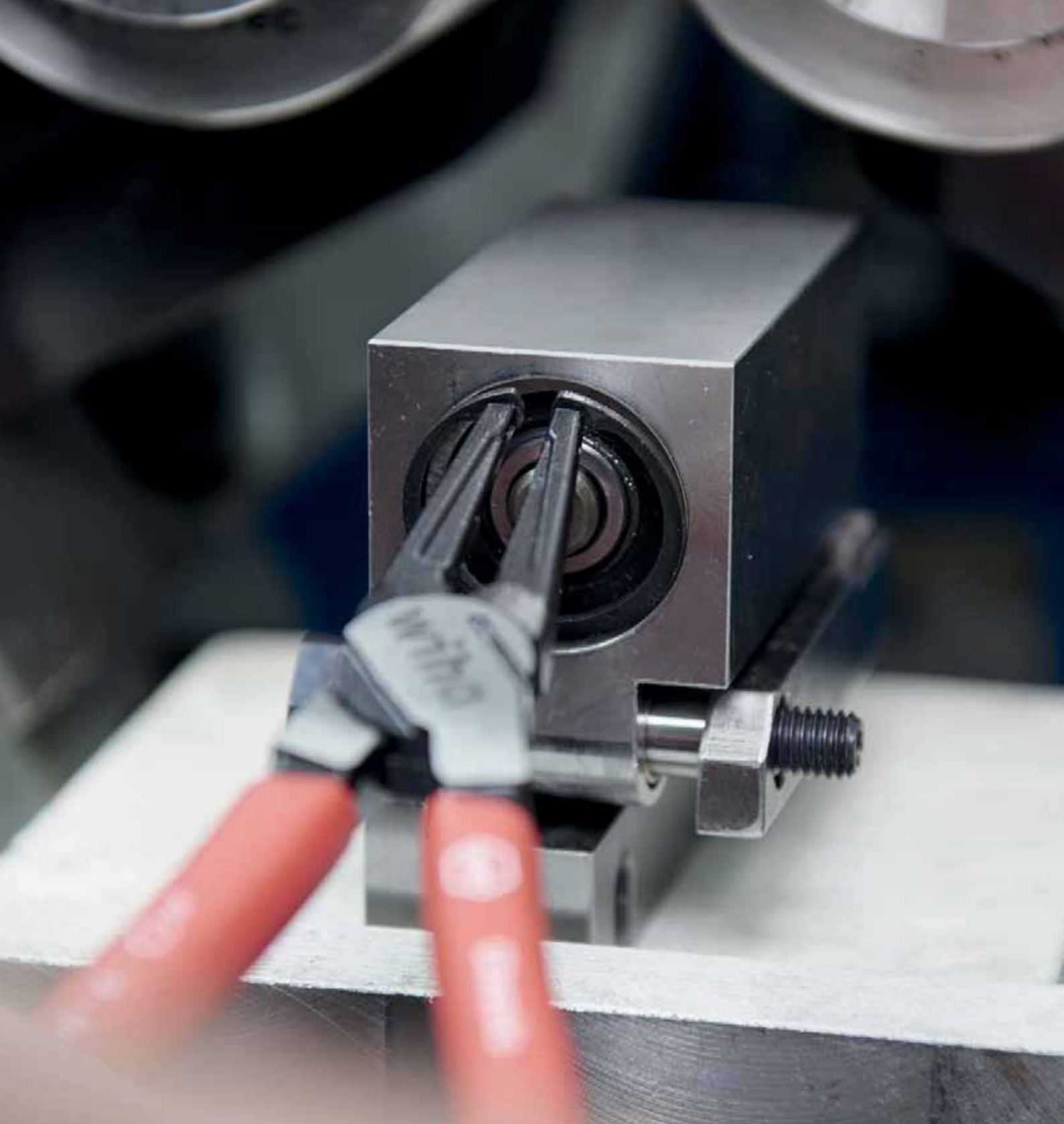

They make our circlip pliers for the Classic series head and shoulders above the rest: MagicTips®, the precision tips made of high-performance steel. Additionally hardened, they offer a high level of resistance to wear and therefore ensure a long shelf-life. The special latching feature is as unique as it is useful, and prevents jumping of the circlips - and therefore any reworking in the motor or working space caused by lost circlips. And thanks to the non-slip pliers handle, precise work is also guaranteed in unfavourable situations. Hard as nails, durable, safe, accurate: These qualities make Wiha MagicTips® circlip pliers useful and indispensable helpers during day-to-day work.

- **Lowers your costs**  
Prevents damage caused by lost circlips in the work area.
- **Saves time**  
Safe and sturdy grip on circlips.



## Pliers set Classic with MagicTips®



**Lowers your costs:** Prevents damage caused by lost circlips in the work area. **Saves time:** Safe and sturdy grip on circlips.

**Circlip pliers 4-pcs.**

Z99000701

Order-No.



34708

1

☉ J 1, 140 mm / J 2, 180 mm

☉ A 1, 140 mm / A 2, 185 mm

with safety latching function MagicTips®

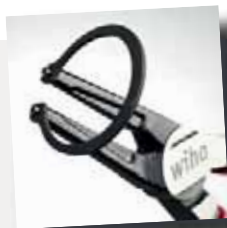
**INFOBOX:**  
**MagicTips®**
**Wiha MagicTips® – Top of their class.**

- **Maximum grip:** The special latching function preventing jumping away of the safety rings makes the Wiha circlip pliers truly unique.
- **Hard as steel:** Additional hardening of tips means high wear resistance and therefore excellent durability.
- **Precise:** Precision tips of high performance steel for maximum grip and high stability.

Circlip pliers Classic with MagicTips®



**Lowers your costs:** Prevents damage caused by lost circlips in the work area. **Saves time:** Safe and sturdy grip on circlips.

for inner rings (holes), straight

Z 33 4 01

Order-No.		mm	in		
34688	J 0	140	5 1/2"	8 - 13	5
34689	J 1	140	5 1/2"	12 - 25	5
34690	J 2•	180	7"	19 - 60	5
34691	J 3•	220	9"	40 - 100	5
34692	J 4•	305	12"	85 - 140	5

•with safety latching function MagicTips®  
DIN ISO 5256

Circlip pliers Classic with MagicTips®



**Lowers your costs:** Prevents damage caused by lost circlips in the work area. **Saves time:** Safe and sturdy grip on circlips.

for outer rings (shafts), straight

Z 34 4 01

Order-No.		mm	in		
34698	A 0	140	5 1/2"	3 - 10	5
34699	A 1	140	5 1/2"	10 - 25	5
34700	A 2•	185	7"	19 - 60	5
34701	A 3•	240	9"	40 - 100	5
34702	A 4•	300	12"	85 - 140	5

•with safety latching function MagicTips®  
DIN ISO 5256

Circlip pliers Classic with MagicTips®



**Lowers your costs:** Prevents damage caused by lost circlips in the work area. **Saves time:** Safe and sturdy grip on circlips.

for inner rings (holes) with angled shape

Z 33 5 01

Order-No.		mm	in		
34693	J 01	140	5 1/2"	8 - 13	5
34694	J 11	140	5 1/2"	12 - 25	5
34695	J 21•	180	7"	19 - 60	5
34696	J 31•	220	9"	40 - 100	5
34697	J 41•	305	12"	85 - 140	5

•with safety latching function MagicTips®  
DIN ISO 5256

Circlip pliers Classic with MagicTips®



**Lowers your costs:** Prevents damage caused by lost circlips in the work area. **Saves time:** Safe and sturdy grip on circlips.

for outer rings (shafts), angled

Z 34 5 01

Order-No.		mm	in		
34703	A 01	140	5 1/2"	3 - 10	5
34704	A 11	140	5 1/2"	10 - 25	5
34705	A 21•	185	7"	19 - 60	5
34706	A 31•	240	9"	40 - 100	5
34707	A 41•	300	12"	85 - 140	5

•with safety latching function MagicTips®  
DIN ISO 5256



**Protect your health**

Wiha pliers are kind to the muscles and ergonomic to work with, permanently reducing wrist strain.

**Lowers your costs**

Thanks to the integration and combination of several operations in one tool, this removes the need for several tools.

**Offers you full protection**

Each tool individually tested at 10,000 V AC and approved for 1,000 V AC.

# Stripping/ insulating / crimping

## For tidy cable ends.

Wiha crimping tools guarantee clean, precise crimping of components. Wiha offers a range of crimp tools for wire-end sleeves, male blade connectors, as well as cable eyes and contacts. Special highlights of the crimp tool include the automatic square crimping capacity and a rotating crimp head. The 360° rotation offers 45° locking positions, with which side as well as frontal access is possible. This way, crimping wire-end sleeves on difficult to access cables is easily accomplished. The automatic crimp tools from Wiha are excellently suited for processing wire-end sleeves with and without insulating collar. Due to the large crimping range from 0.08 – 16 mm<sup>2</sup> only one tool is required for working on wire-end sleeves with larger and smaller diameters. At the same high quality level as the automatic crimp tools, the crimp tools for cable eyes, contacts and male blade connectors also guarantee absolute crimping process safety coupled with comfortable work thanks to their impact-reducing plastic handles. The "electrical engineering accessories" product range offers the ideal solutions to complement the crimp tools, including superior quality innovatively packaged wire-end sleeves and connectors.

**"Due to the large crimping range of the automatic crimping pliers I always have the right tool for practically all wire-end sleeves at my disposal. Even with wire-end sleeves with small diameters, the crimping process is problem-free thanks to the feed aid."**

Ralf Flaig



# Three functions – one tool.



Less tools means less weight, better handling and more efficient work. The Wiha Professional electric TriCut installation pliers combine three tools in one, ideal for the three operations cutting-to-length, stripping and skinning. And it does all this while saving you energy: Due to an ergonomically shaped, specifically angled plier head forged from high-quality steel. The low-wear, inlaid joint with heavy-duty riveting makes the pliers particularly robust and durable, and production and testing according to IEC 60900, VDE/ GS certification and individual piece testing at 10,000 V AC ensures uncompromising safety.

- **Simplifies your work**  
The angled shape of the head allows work to be performed in hard-to-reach spaces such as installation boxes.
- **Increases your efficiency**  
Three tools in one. Saves 60% volume and 50% less weight for 100% efficiency.
- **Lowers your costs**  
Now you only need one tool for three tasks: cutting to length, stripping and skinning.
- **Offers you full protection**  
Each tool individually tested at 10,000 V AC and approved for 1,000 V AC.

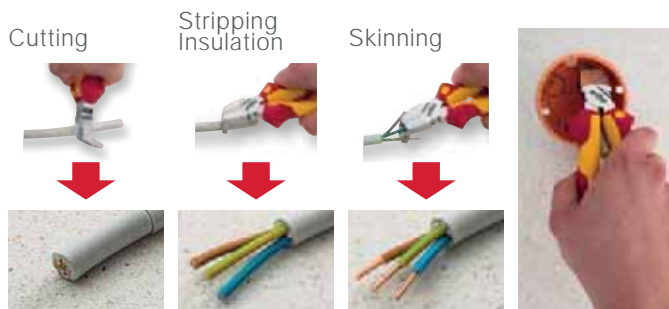

## Installation pliers TriCut Professional electric



**Simplifies your work:** The angled head allows you to work in hard-to-reach places such as installation sockets. **Lowers your costs:** Durable thanks to high-quality, chrome-plated plier surface to prevent corrosion. **Saves money:** Now you only need one tool for three tasks: cutting to length, stripping and skinning. **Increases your efficiency:** Three tools in one. Saves 60% volume and 50% less weight for 100% efficiency. **Offers you full protection:** Each tool individually tested at 10,000 V AC and approved for 1,000 V AC.



Z 14 1 06

Order-No.				$\varnothing$ mm	mm <sup>2</sup>	
38552	170	7"	13	1.6	1.5 - 2.5	5

Manufactured acc. to IEC 60900.

### INFOBOX: Cutting capacity info



	Example
1 - 5	copper, aluminium
6 - 10	Iron nails
11 - 15	Screws
16 - 21	Hardened spring steel

Stripping diagonal cutters Professional electric with DynamicJoint®



**Saves money:** Two tools in one for cutting to length and skinning. **Protects your health:** Special DynamicJoint® design reduces effort required for cutting. **Lowers your costs:** Durable thanks to high-quality, chrome-plated plier surface to prevent corrosion. **Offers you full protection:** Each tool individually tested at 10,000 V AC and approved for 1,000 V AC.

Z 14 0 06

Order-No.	mm	in	mm	mm <sup>2</sup>	mm
26745	160	6 1/2"	13	1.5 - 2.5	5

Manufactured acc. to IEC 60900.

Stripping pliers Professional electric



**Increases your efficiency:** Skinning of several cross-sections due to wide variety of settings. **Protects your health:** Reduces strain from continuous work thanks to opening spring. **Lowers your costs:** Durable thanks to high-quality, chrome-plated plier surface to prevent corrosion. **Offers you full protection:** Each tool individually tested at 10,000 V AC and approved for 1,000 V AC.

Z 55 0 06

Order-No.	mm	in	mm	mm <sup>2</sup>	mm
26847	160	6 1/2"	0 - 5	0 - 10	5

Stripping multi-tool



**Simplifies your work:** Cable routing ensures safe and easy stripping.  
**Simplifies your work:** Enables stripping in hard-to-reach places such as installation sockets. **Increases your efficiency:** 4 in 1: round stripper, longitudinal stripper, hook knife and stripping station in one tool.

for round cable

Z 74 0 06

Order-No.	mm	in	mm <sup>2</sup>	AWG	Ø mm	SB	Icon
44242	125	5"	0.5 - 6	20 - 10	8 - 13	x	1

Stripping tool with self-rotating drag blade



**Simplifies your work:** Perfect handling thanks to ergonomic handle shape. **Saves time:** Automatic setting from round to longitudinal cutting. **Saves time:** Quick exchange of the drag blade thanks to readily available replacement blade in the handle. **Increases your efficiency:** Stripping of all standard cross-sections through continuous setting.

for round cables

Z 72 0 06

Order-No.	mm	in	Ø mm	SB	Icon
44619	165	6 1/2"	4 - 28	x	1

Stripping tool with self-rotating drag blade



**Increases your efficiency:** Stripping of all standard cross-sections through continuous setting. **Simplifies your work:** Automatic setting from round to longitudinal cutting. **Saves time:** Quick exchange of the drag blade thanks to readily available replacement blade in the handle.

for round cables

Z 72 0 06

Order-No.	mm	in	Ø mm	SB	Icon
44240	130	5 1/8"	4 - 28	x	1

Stripping tool



**Simplifies your work:** Enables stripping in hard-to-reach places such as installation sockets. **Simplifies your work:** Perfect handling thanks to ergonomic handle shape. **Increases your efficiency:** Stripping of all standard cross-sections through continuous setting.

for round cable

Z 73 0 06

Order-No.	mm	in	Ø mm	SB	Icon
44620	140	5 1/2"	6 - 13	x	1

## Automatic stripping tool



**Simplifies your work:** Unrestricted access to hard-to-reach work areas thanks to extremely slim handle shape. **Saves money:** Two tools in one for cutting to length and skinning. **Increases your efficiency:** Damage-free stripping thanks to automatic adjustment to cable diameter.

up to 6 mm<sup>2</sup>

Z 57 5 06

Order-No.	mm	mm <sup>2</sup>	AWG	Ømm	SB	
44617	190	7 1/2" - 6	0.2 - 6 - 10	24 - 10	2	x 1

## Stripping and assembly tool



**Simplifies your work:** Improved accessibility in confined working situations such as in installation boxes due to narrow design. **Saves time:** Stripping of coaxial cable in only one work step with fixed dimensions and length stop. **Saves space:** Compact tool with all functions for the processing and assembly of coaxial cables with F-connector.

## for coaxial cable with F-connector

Z 73 2 06

Order-No.	mm	mm	Ømm	mm	SB	
44241	125	5"	6 - 8	11.0 mm	x	1

Stripping tool automatic



**Increases your efficiency:** Automatic stripping pliers for a wide range of cables between 0.03 and 16 mm<sup>2</sup>. **Protects your health:** Damper enclosed for large cable cross-sections to reduce recoil and protect wrists. **Lowers your costs:** Long-lasting and robust thanks to metal blade insert. **Saves time:** Blades quickly exchanged by immediately available replacement blades in the handle.

up to 16 mm<sup>2</sup> in blister pack

Z 57 0 06

Order-No.	mm	8"	mm <sup>2</sup>	AWG	SB	
42062	200	8"	0.03 - 16	32 - 5	x	1

Spare blade and gripping jaw set



for automatic stripping tool (42062)

Z57000106K

Order-No.	
42162	2

Cable stripping knife



**Offers you full protection:** Each tool individually tested at 10,000 V AC and approved for 1,000 V AC.

straight cutting edge for round cables in blister pack

24680

Order-No.	mm	8"	SB	
38798	200	8"	x	1

Manufactured acc. to IEC 60900.

Cable stripping knife



**Lowers your costs:** No damage to wire insulation through sliding shoe on tip.

hooked blade with sliding shoe for round cable, in blister pack

24678

Order-No.	mm	8"	SB	
36053	200	8"	x	1

Manufactured acc. to IEC 60900.

INFOBOX:  
Stripping tool,  
automatic up to 16mm<sup>2</sup>



- These pliers can handle a wide range of cables, thus combining two pairs of pliers in one.
- The supplied damper can be used to lessen recoil caused by larger cable gauges, such as those greater than 6 mm<sup>2</sup>, thus helping to protect wrists.
- Precise cutting to length thanks to adjustable longitudinal stop.
- Integrated hand protection along the cutting edge guards against injury.

Crimping tools



**Increases your safety:** Safe working through automatic pressing adjustment.

for wire-end sleeves

Z 62 0 06

Order-No.	mm	mm <sup>2</sup>	AWG	SB	
40342	220	0.14 - 16	26 - 5	x	1

Crimping tools



**Increases your safety:** Safe working through automatic pressing adjustment.

for non-insulated male blade connectors

Z 62 0 06

Order-No.	mm	mm <sup>2</sup>	AWG	
33842	220	0.25 - 6	24 - 10	1

Crimping tools



**Increases your safety:** Safe working through automatic pressing adjustment.

for insulated terminals and connectors

Z 62 0 06

Order-No.	mm	mm <sup>2</sup>	AWG	
33841	220	0.5 - 6	20 - 10	1

For use with pin-shaped cable eyes with insulating sleeve according to DIN 46231, ring-shaped cable eyes with insulating sleeve according to DIN 46237, pin bushing with insulating sleeve according to DIN 46245 Part 1-3.

Crimping tools



**Increases your safety:** Safe working through automatic pressing adjustment.

for non-insulated cable eye with closed sleeve

Z 62 0 06

Order-No.	mm	mm <sup>2</sup>	AWG	
33843	220	0.1 - 16	26 - 6	1

## Automatic crimp tool



**Increases your efficiency:** Automatic adjustment of wire-end sleeve size with suitable crimping force for a large coverage area of 0.08-16mm<sup>2</sup>. **Makes handling easier:** Thanks to hexagonal crimping, small wire-end sleeves no longer get caught. **Lowers your costs:** An integrated lever enables users to interrupt the crimping process at any time to protect the pliers. **Increases your safety:** Safe work through feed aid prevents crimping the plastic cover of wire-end sleeves.

## for wire-end sleeves hex crimping

Z 62 0 06

Order-No.	mm	mm <sup>2</sup>	AWG	SB	
41246	210	0.08 - 16	28 - 5	x	1

## Automatic crimp tool



**Makes handling easier:** 360° rotatable crimping die open on both sides for optimal accessibility. **Increases your efficiency:** Automatic adjustment to the wire-end sleeve size with suitable crimping force for a large application area of 0.08 - 16 mm<sup>2</sup>. **Lowers your costs:** An emergency lever enables users to manually interrupt the crimping process at any time to protect the pliers.

## For wire-end sleeves square crimping with rotating crimping head

Z 62 0 06

Order-No.	mm	mm <sup>2</sup>	AWG	SB	
45223	193	0.08 - 16	28 - 5	x	1

**INFOBOX:**  
**Automatic crimp tool**
**Hex crimping for wire-end sleeves**

- Process-safe hexagonal crimping prevents smaller wire-end sleeves from snagging.
- These crimping pliers can handle all standard applications with a crimping range between 0.08 and 16 mm<sup>2</sup>.
- Suitable for both single wire-end sleeves and twin wire-end sleeves thanks to automatic crimping.

**INFOBOX:**  
**Automatic crimp tool**
**For wire-end sleeves square crimping with rotating crimping head**

- Large application area of 0.08 - 16 mm<sup>2</sup> (Twin: 2 x 10 mm<sup>2</sup>) and automatic adjustment to the wire-end sleeve size.
- A 360° revolving crimp head offers 45° locking positions for secure crimping in any position (front, side, and diagonal).
- High power transmission through a toggle mechanism.
- Soft handles with anti-slip protection for ergonomic and safe work.

Crimping pliers Professional electric



**Meets your requirements:** Safe pressing in marked trapezoidal/ semi-circular profiles. **Lowers your costs:** Durable thanks to high-quality, chrome-plated plier surface to prevent corrosion. **Offers you full protection:** Each tool individually tested at 10,000 V AC and approved for 1,000 V AC.

Z 60 0 06

Order-No.	mm	in	mm <sup>2</sup>	
35861	145	5 3/4"	0.25 - 2.5	5

Crimping pliers Professional electric



**Meets your requirements:** Safe pressing in marked trapezoidal/ semi-circular profiles. **Lowers your costs:** Durable thanks to high-quality, chrome-plated plier surface to prevent corrosion. **Offers you full protection:** Each tool individually tested at 10,000 V AC and approved for 1,000 V AC.

Z 60 0 06

Order-No.	mm	in	mm <sup>2</sup>	
35862	180	7"	0.25 - 16	5

## Stripping and crimping tool set 4-pcs.



**Increases your efficiency:** Comprehensive assortment of wire end ferrules and cable connectors in a clear and mobile assortment box.

**Increases the quality of your work:** Gas-tight connections thanks to perfect combination of professional tools and high quality connectors.

## with cable connectors 2,600 pcs. colour code DIN in assortment box

93001013

Order-No.



43984

1

●	1 x Automatic crimp tool for wire-end sleeves hex crimping
	1 x Stripping tool automatic up to 16 mm <sup>2</sup> in blister pack
●	1 x Crimping tools for insulated cable eyes and contacts
□	400 x 0.5 mm <sup>2</sup> / 400 x 0.75 mm <sup>2</sup> / 400 x 1 mm <sup>2</sup> / 300 x 1.5 mm <sup>2</sup> / 200 x 2.5 mm <sup>2</sup> / 100 x 4 mm <sup>2</sup> / 50 x 6 mm <sup>2</sup> / 50 x 10 mm <sup>2</sup> / 50 x 16 mm <sup>2</sup>
□	50 x 0.5 - 1 mm <sup>2</sup> / 50 x 0.5 - 1 mm <sup>2</sup> / 50 x 1.5 - 2.5 mm <sup>2</sup> / 50 x 1.5 - 2.5 mm <sup>2</sup> / 50 x 4 - 6 mm <sup>2</sup> / 50 x 4 - 6 mm <sup>2</sup>
□	50 x 0.5 - 1 mm <sup>2</sup> / 50 x 1.5 - 2.5 mm <sup>2</sup> / 50 x 4 - 6 mm <sup>2</sup>
□	50 x 0.5 - 1 mm <sup>2</sup> / 50 x 1.5 - 2.5 mm <sup>2</sup>
□	50 x 0.5 - 1 mm <sup>2</sup> / 50 x 1.5 - 2.5 mm <sup>2</sup>
	1 x Box

## With connection elements, 2,600 units, colour code 1 (FR), in assortment box

93001011

Order-No.



43982

1

●	1 x Automatic crimp tool for wire-end sleeves hex crimping
	1 x Stripping tool automatic up to 16 mm <sup>2</sup> in blister pack
●	1 x Crimping tools for insulated cable eyes and contacts
□	400 x 0.5 mm <sup>2</sup> / 400 x 0.75 mm <sup>2</sup> / 400 x 1 mm <sup>2</sup> / 300 x 1.5 mm <sup>2</sup> / 200 x 2.5 mm <sup>2</sup> / 100 x 4 mm <sup>2</sup> / 50 x 6 mm <sup>2</sup> / 50 x 10 mm <sup>2</sup> / 50 x 16 mm <sup>2</sup>
□	50 x 0.5 - 1 mm <sup>2</sup> / 50 x 0.5 - 1 mm <sup>2</sup> / 50 x 1.5 - 2.5 mm <sup>2</sup> / 50 x 1.5 - 2.5 mm <sup>2</sup> / 50 x 4 - 6 mm <sup>2</sup> / 50 x 4 - 6 mm <sup>2</sup>
□	50 x 0.5 - 1 mm <sup>2</sup> / 50 x 1.5 - 2.5 mm <sup>2</sup> / 50 x 4 - 6 mm <sup>2</sup>
□	50 x 0.5 - 1 mm <sup>2</sup> / 50 x 1.5 - 2.5 mm <sup>2</sup>
□	50 x 0.5 - 1 mm <sup>2</sup> / 50 x 1.5 - 2.5 mm <sup>2</sup>
	1 x Box

## Insert boxes set



## 16-pcs. for assortment box connector elements

93001911R

Order-No.



43995

1

8 x Assortment box, small

8 x Assortment box, large

Spare part: Insert boxes for the connection elements assortment box 43982 and 43984

## Stripping and crimping tool set 5-pcs.



**Simplifies your work:** Easy removal and safe storage thanks to the pocket box with latching twist cap. **Increases your efficiency:** Ideal for mobile use thanks to compact, stackable pocket box. **Increases the quality of your work:** Gas-tight connections thanks to perfect combination of professional tools and high quality connectors. **Increases the quality of your work:** Skin and crimp tool coupled with matching wire-end sleeves and connectors for high-quality crimping.

## with wire end ferrules 500 pcs. colour code DIN in L-Boxx Mini

93001003

Order-No.



43987

1

## Insulating / crimping

- 1 x Automatic crimp tool for wire-end sleeves hex crimping
- 1 x Stripping tool automatic up to 16 mm<sup>2</sup> in blister pack
- Wire end sleeves with plastic collar set 0.5–2.5 mm<sup>2</sup>, 400 units, DIN colour code, in dispenser (43904)  
50 x 0.5 mm<sup>2</sup> / 100 x 0.75 mm<sup>2</sup> / 100 x 1 mm<sup>2</sup> / 100 x 1.5 mm<sup>2</sup> / 50 x 2.5 mm<sup>2</sup>
- Wire end sleeves with plastic collar set 4–16 mm<sup>2</sup>, 100 units, DIN colour code, in dispenser (43903)  
50 x 4 mm<sup>2</sup> / 20 x 6 mm<sup>2</sup> / 20 x 10 mm<sup>2</sup> / 10 x 16 mm<sup>2</sup>

## Storage

1 x L Boxx Mini

## With wire end sleeves, 500 units, colour code 1 (FR), in L Boxx Mini

93001001

Order-No.



43985

1

## Insulating / crimping

- 1 x Automatic crimp tool for wire-end sleeves hex crimping
- 1 x Stripping tool automatic up to 16 mm<sup>2</sup> in blister pack
- Wire end sleeves with plastic collar set 0.5–2.5 mm<sup>2</sup>, 400 units, colour code 1 (FR), in dispenser (43900)  
50 x 0.5 mm<sup>2</sup> / 100 x 0.75 mm<sup>2</sup> / 100 x 1 mm<sup>2</sup> / 100 x 1.5 mm<sup>2</sup> / 50 x 2.5 mm<sup>2</sup>
- Wire end sleeves with plastic collar set 4–16 mm<sup>2</sup>, 100 units, colour code 1 (FR) in dispenser (43899)  
50 x 4 mm<sup>2</sup> / 20 x 6 mm<sup>2</sup> / 20 x 10 mm<sup>2</sup> / 10 x 16 mm<sup>2</sup>

## Storage

1 x L Boxx Mini

## Wire-end sleeves display

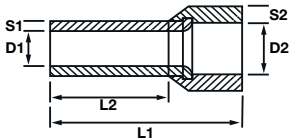

**Simplifies your work:** Easy removal and safe storage thanks to the pocket box with latching twist cap. **Increases your efficiency:** Ideal for mobile use thanks to compact, stackable pocket box. **Increases your safety:** Cable breakages prevented thanks to protected individual wires. **Increases your safety:** High thermal resistance up to 105 °C. **Makes handling easier:** Quick, easy cable insertion thanks to funnel sleeve. **Increases your process reliability:** Consistently high processing quality for permanent safe contact. **Increases your efficiency: Makes handling easier:**

Colour code DIN, 0.5 - 10 mm<sup>2</sup> in polyester bag and 0.5 - 16 mm<sup>2</sup> in organiser box

C000CVH

Order-No.



44007

1

8 x Wire end sleeves with plastic collar set 0.5–2.5 mm<sup>2</sup>, 400 units, DIN colour code, in dispenser (43904) 50 x 0,5 mm<sup>2</sup> / 100 x 0,75 mm<sup>2</sup> / 100 x 1 mm<sup>2</sup> / 100 x 1,5 mm<sup>2</sup> / 50 x 2,5 mm<sup>2</sup>

8 x Wire end sleeves with plastic collar set 4–16 mm<sup>2</sup>, 100 units, DIN colour code, in dispenser (43903) 50 x 4 mm<sup>2</sup> / 20 x 6 mm<sup>2</sup> / 20 x 10 mm<sup>2</sup> / 10 x 16 mm<sup>2</sup>

 80 x 0.5 mm<sup>2</sup> / 80 x 0.75 mm<sup>2</sup> / 60 x 1 mm<sup>2</sup> / 60 x 1.5 mm<sup>2</sup> / 50 x 2.5 mm<sup>2</sup> / 30 x 4 mm<sup>2</sup> / 20 x 6 mm<sup>2</sup> / 20 x 10 mm<sup>2</sup>

Colour code 1 (FR), 0.5 - 10 mm<sup>2</sup> in polyester bag and 0.5 - 16 mm<sup>2</sup> in organiser box

C000AVH

Order-No.



44005

1

8 x Wire end sleeves with plastic collar set 0.5–2.5 mm<sup>2</sup>, 400 units, colour code 1 (FR), in dispenser (43900) 50 x 0,5 mm<sup>2</sup> / 100 x 0,75 mm<sup>2</sup> / 100 x 1 mm<sup>2</sup> / 100 x 1,5 mm<sup>2</sup> / 50 x 2,5 mm<sup>2</sup>

8 x Wire end sleeves with plastic collar set 4–16 mm<sup>2</sup>, 100 units, colour code 1 (FR) in dispenser (43899) 50 x 4 mm<sup>2</sup> / 20 x 6 mm<sup>2</sup> / 20 x 10 mm<sup>2</sup> / 10 x 16 mm<sup>2</sup>

 80 x 0.5 mm<sup>2</sup> / 80 x 0.75 mm<sup>2</sup> / 60 x 1 mm<sup>2</sup> / 60 x 1.5 mm<sup>2</sup> / 50 x 2.5 mm<sup>2</sup> / 30 x 4 mm<sup>2</sup> / 20 x 6 mm<sup>2</sup> / 20 x 10 mm<sup>2</sup>

## Wire end sleeves with plastic collar set



**Simplifies your work:** Easy removal and safe storage thanks to the pocket box with latching twist cap. **Increases your safety:** Cable breakages prevented thanks to protected individual wires. **Increases your safety:** High thermal resistance up to 105 °C. **Makes handling easier:** Quick, easy cable insertion thanks to funnel sleeve. **Increases your efficiency:** Ideal for mobile use thanks to compact, stackable pocket box. **Increases your process reliability:** Consistently high processing quality for permanent safe contact.

0.5–2.5 mm<sup>2</sup>, 400 units, DIN colour code, in dispenser

C000C400

Order-No.



43904

1

50 x 0.5 mm<sup>2</sup> / 100 x 0.75 mm<sup>2</sup> / 100 x 1 mm<sup>2</sup> / 100 x 1.5 mm<sup>2</sup> / 50 x 2.5 mm<sup>2</sup>

0.5–2.5 mm<sup>2</sup>, 400 units, colour code 1 (FR), in dispenser

C000A400

Order-No.



43900

1

50 x 0.5 mm<sup>2</sup> / 100 x 0.75 mm<sup>2</sup> / 100 x 1 mm<sup>2</sup> / 100 x 1.5 mm<sup>2</sup> / 50 x 2.5 mm<sup>2</sup>

4–16 mm<sup>2</sup>, 100 units, DIN colour code, in dispenser

C000C100

Order-No.



43903

1

50 x 4 mm<sup>2</sup> / 20 x 6 mm<sup>2</sup> / 20 x 10 mm<sup>2</sup> / 10 x 16 mm<sup>2</sup>

4–16 mm<sup>2</sup>, 100 units, colour code 1 (FR) in dispenser

C000A100

Order-No.



43899

1

50 x 4 mm<sup>2</sup> / 20 x 6 mm<sup>2</sup> / 20 x 10 mm<sup>2</sup> / 10 x 16 mm<sup>2</sup>

## Twin wire end sleeves with plastic collar set



**Simplifies your work:** Easy removal and safe storage thanks to the pocket box with latching twist cap. **Increases your safety:** Cable breakages prevented thanks to protected individual wires. **Increases your safety:** High thermal resistance up to 105 °C. **Makes handling easier:** Quick, easy cable insertion thanks to funnel sleeve. **Increases your efficiency:** Ideal for mobile use thanks to compact, stackable pocket box. **Increases your process reliability:** Consistently high processing quality for permanent safe contact.

2 x 0.75 - 2 x 2.5 mm<sup>2</sup>, 200 units, DIN colour code, in dispenser

C001C200

Order-No.



43907

1

50 x 2 x 0.75 / 50 x 2 x 1 / 50 x 2 x 1.5 / 50 x 2 x 2.5

2 x 0.75 - 2 x 2.5 mm<sup>2</sup>, 200 units, colour code 1 (FR), in dispenser

C001A200

Order-No.



43905

1

50 x 2 x 0.75 / 50 x 2 x 1 / 50 x 2 x 1.5 / 50 x 2 x 2.5

## Wire end sleeves with plastic collar set

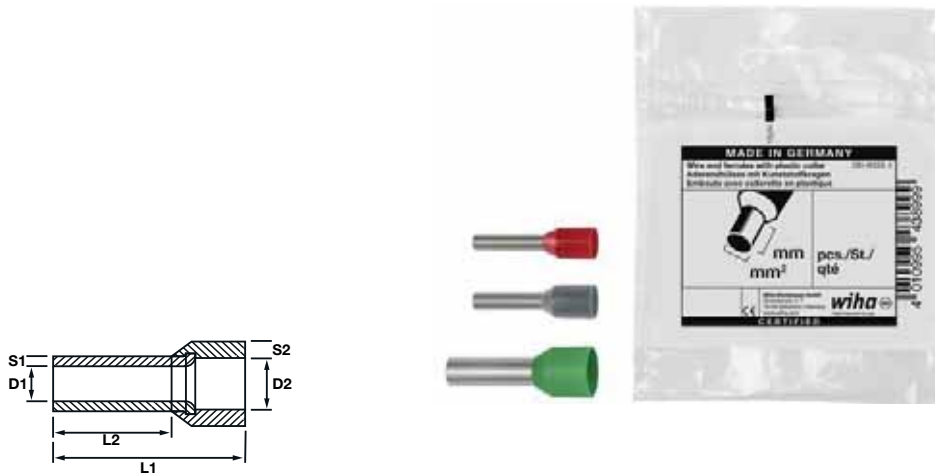

**Increases your safety:** Cable breakages prevented thanks to protected individual wires. **Increases your safety:** High thermal resistance up to 105 °C. **Makes handling easier:** Quick, easy cable insertion thanks to funnel sleeve. **Increases your process reliability:** Consistently high processing quality for permanent safe contact.

## 100 units, colour code 1 (FR) / DIN

C000A

Order-No.		mm <sup>2</sup>	AWG	D1	D2	L1	L2	S1	S2	↓	
43911	white	0.5	20	1	2.6	14	8	0.15	0.25	100	1
43996	grey	0.75	18	1.2	2.8	14	8	0.15	0.25	100	1
43913	red	1	18	1.4	3	14	8	0.15	0.25	100	1
43914	black	1.5	16	1.7	3.5	14	8	0.15	0.25	100	1
43927	blue	2.5	14	2.2	4.2	14	8	0.15	0.25	100	1
43928	grey	4	12	2.8	4.8	17	10	0.2	0.3	100	1
43932	yellow	6	10	3.5	6.3	20	12	0.2	0.3	100	1
43933	red	10	8	4.5	7.6	22	12	0.2	0.4	50	1
43934	blue	16	6	5.8	8.8	24	12	0.2	0.4	50	1

























## 100 units, colour code 1 (FR)

C000A

Order-No.		mm <sup>2</sup>	AWG	D1	D2	L1	L2	S1	S2	↓	
43908	brown•	0.14	26	0.7	1.6	12	6	0.15	0.25	100	1
43909	purple•	0.25	24	0.75	1.8	12	6	0.15	0.25	100	1
43910	pink•	0.34	22	0.8	2	12	6	0.15	0.25	100	1
43911	white	0.5	20	1	2.6	14	8	0.15	0.25	100	1
43912	blue	0.75	18	1.2	2.8	14	8	0.15	0.25	100	1
43913	red	1	18	1.4	3	14	8	0.15	0.25	100	1
43914	black	1.5	16	1.7	3.5	14	8	0.15	0.25	100	1
43915	grey	2.5	14	2.2	4.2	14	8	0.15	0.25	100	1
43916	orange	4	12	2.8	4.8	17	10	0.2	0.3	100	1
43917	green	6	10	3.5	6.3	20	12	0.2	0.3	100	1
43918	brown	10	8	4.5	7.6	22	12	0.2	0.4	50	1
43919	ivory	16	6	5.8	8.8	24	12	0.2	0.4	50	1

•Extension size for DIN dimensions

**INFOBOX:**  
**Wire end ferrules with plastic collar**

				Colour code DIN		Colour code 1 (FR)	
mm <sup>2</sup>	mm				Order-No.		Order-No.
0,14	6	100	40				brown 43908
0,25	6	100	40				purple 43909
0,34	6	100	40				light pink 43910
0,50	8	100	40		white 43911		white 43911
0,75	8	100	40		grey 43996		blue 43912
1,00	8	100	60		red 43913		red 43913
1,50	8	100	60		black 43914		black 43914
2,50	8	100	50		blue 43927		grey 43915
4,00	10	100	30		grey 43928		orange 43916
6,00	12	100	20		yellow 43932		green 73917
10,00	12	50	20		red 43933		brown 43918
16,00	12	50	20		blue 43934		ivory 43919

Additional dimension. Non-DIN size.



## Twin wire end ferrules with plastic collar

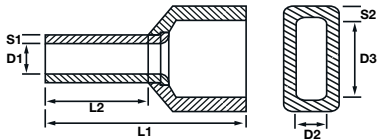
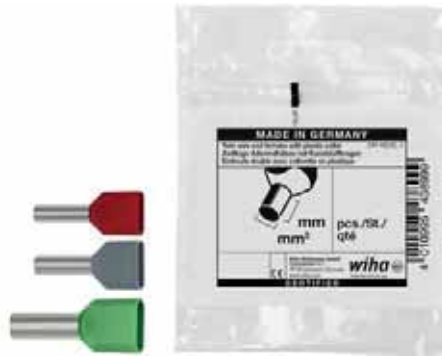

**Increases your process reliability:** Consistently high processing quality for permanent safe contact. **Makes handling easier:** Quick, easy cable insertion thanks to funnel sleeve. **Increases your safety:** Cable breakages prevented thanks to protected individual wires. **Increases your safety:** High thermal resistance up to 105 °C.

## 100 units, colour code 1 (FR) &amp; DIN

C001A





















Order-No.		mm <sup>2</sup>	AWG	D1	D2	D3	L1	L2	S1	S2	↓	
43935	white	2 x 0.5	2 x 20	1.4	2.5	4.7	15	8	0.15	0.25	100	1
43951	grey	2 x 0.75	2 x 18	1.7	2.8	5	15	8	0.15	0.25	100	1
43937	red	2 x 1	2 x 18	1.95	3.4	5.4	15	8	0.15	0.3	100	1
43938	black	2 x 1.5	2 x 16	2.2	3.6	6.6	16	8	0.15	0.3	100	1
43947	blue	2 x 2.5	2 x 14	2.8	4.2	7.8	18.5	10	0.2	0.3	100	1
43948	grey	2 x 4	2 x 12	3.7	4.9	8.8	23	12	0.2	0.4	50	1
43952	yellow	2 x 6	2 x 10	4.8	6.9	10	26	14	0.2	0.4	50	1
43953	red	2 x 10	2 x 8	6.4	7.2	13	26	14	0.2	0.4	25	1

## 100 units, colour code 1 (FR) &amp; DIN

C001A

Order-No.		mm <sup>2</sup>	AWG	D1	D2	D3	L1	L2	S1	S2	↓	
43935	white	2 x 0.5	2 x 20	1.4	2.5	4.7	15	8	0.15	0.25	100	1
43936	blue	2 x 0.75	2 x 18	1.7	2.8	5	15	8	0.15	0.25	100	1
43937	red	2 x 1	2 x 18	1.95	3.4	5.4	15	8	0.15	0.3	100	1
43938	black	2 x 1.5	2 x 16	2.2	3.6	6.6	16	8	0.15	0.3	100	1
43939	grey	2 x 2.5	2 x 14	2.8	4.2	7.8	18.5	10	0.2	0.3	100	1
43940	orange	2 x 4	2 x 12	3.7	4.9	8.8	23	12	0.2	0.4	50	1
43941	green	2 x 6	2 x 10	4.8	6.9	10	26	14	0.2	0.4	50	1
43942	brown	2 x 10	2 x 8	6.4	7.2	13	26	14	0.2	0.4	25	1

**INFOBOX:**  
**Twin wire end ferrules**  
**with plastic collar**

mm <sup>2</sup>	mm			Colour code DIN			Colour code 1 (FR)		
					Best.-Nr.		Best.-Nr.		
2 x 0,50	8	100	30		white	43935		white	43935
2 x 0,75	8	100	20		grey	43951		blue	43936
2 x 1,00	8	100	20		red	43937		red	43937
2 x 1,50	8	100	30		black	43938		black	43938
2 x 2,50	10	100	20		blue	43947		grey	43939
2 x 4,00	12	50	20		grey	43948		orange	43940
2 x 6,00	14	50	15		yellow	43952		green	43941
2 x 10,00	14	25	20		red	43953		brown	43942



## type cable socket, ring-shaped, insulated



**Increases your process reliability:** Consistently high processing quality for permanent safe contact. **Makes handling easier:** Quick, easy cable insertion thanks to funnel sleeve. **Increases your safety:** High thermal resistance up to 105 °C.

100 units as per DIN

C020

Order-No.		mm <sup>2</sup>	AWG		D1	D2	L1	B		
43954	red	0.5 - 1 mm <sup>2</sup>	22 - 16	M4	4.1	4.3	18	8	100	1
43956	red	0.5 - 1 mm <sup>2</sup>	22 - 16	M5	4.1	5.3	19	10	100	1
43958	red	0.5 - 1 mm <sup>2</sup>	22 - 16	M6	4.1	6.5	21	11	100	1
43955	blue	1.5 - 2.5 mm <sup>2</sup>	16 - 14	M4	4.5	4.3	18	8	100	1
43957	blue	1.5 - 2.5 mm <sup>2</sup>	16 - 14	M5	4.5	5.3	20	10	100	1
43959	blue	1.5 - 2.5 mm <sup>2</sup>	16 - 14	M6	4.5	6.5	22	11	100	1
43960	yellow	4 - 6 mm <sup>2</sup>	12 - 10	M6	6.5	6.5	23	11	50	1
43961	yellow	4 - 6 mm <sup>2</sup>	12 - 10	M8	6.5	8.4	26	14	50	1

## Crimp-type cable socket, fork-shaped, insulated

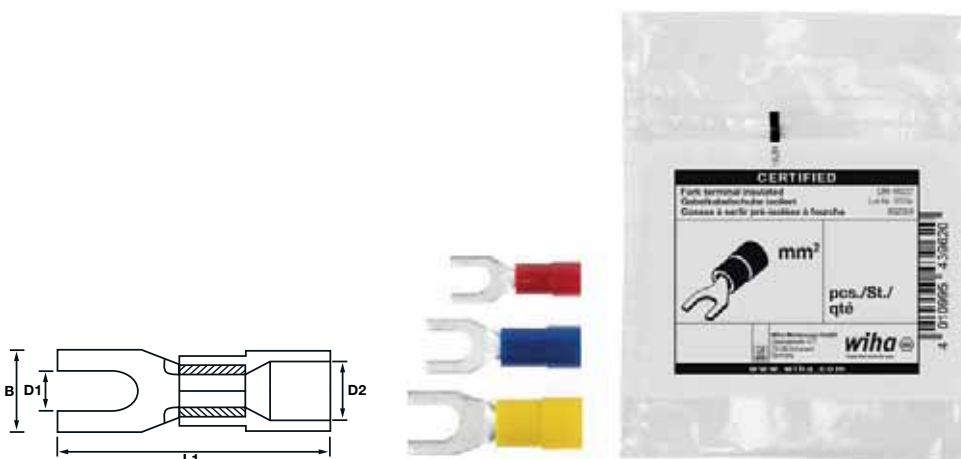

**Increases your process reliability:** Consistently high processing quality for permanent safe contact. **Makes handling easier:** Quick, easy cable insertion thanks to funnel sleeve. **Increases your safety:** High thermal resistance up to 105 °C.

100 units as per DIN

C040

Order-No.		mm <sup>2</sup>	AWG		D1	D2	L1	B		
43962	red	0.5 - 1 mm <sup>2</sup>	22 - 16	M4	4.1	4.3	18	8	100	1
43963	blue	1.5 - 2.5 mm <sup>2</sup>	16 - 14	M4	4.5	4.3	18	8	100	1
43964	yellow	4 - 6 mm <sup>2</sup>	12 - 10	M5	6.5	5.3	22	10	50	1

## Butt connectors, insulated

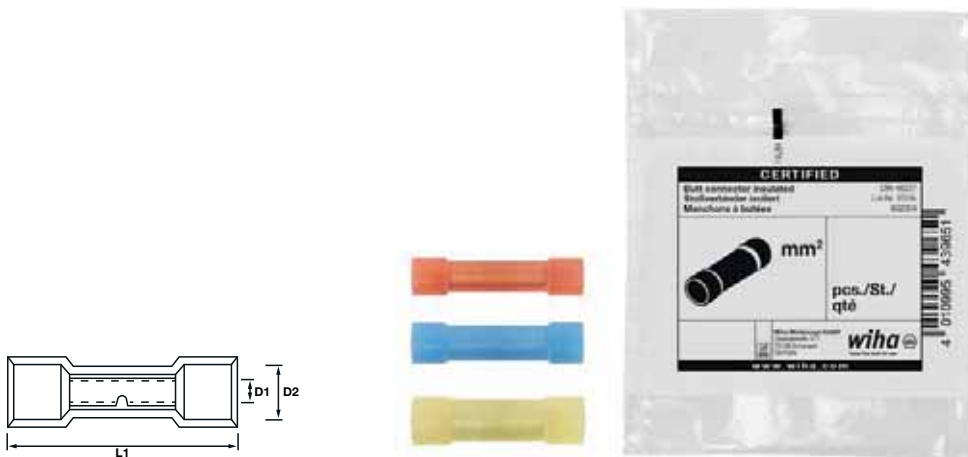

**Increases your process reliability:** Consistently high processing quality for permanent safe contact. **Makes handling easier:** Quick, easy cable insertion thanks to funnel sleeve. **Increases your safety:** High thermal resistance up to 105 °C. **Saves time:** No further insulation required after pressing.

100 units as per DIN

C101

Order-No.		mm <sup>2</sup>	AWG	D1	D2	L1		
43965	red	0.5 - 1 mm <sup>2</sup>	22 - 16	4.1	1.6	26	100	1
43966	blue	1.5 - 2.5 mm <sup>2</sup>	16 - 14	4.5	2.3	26	100	1
43967	yellow	4 - 6 mm <sup>2</sup>	12 - 10	6.5	3.6	28	50	1

## Female blade connectors, insulated



**Increases your process reliability:** Consistently high processing quality for permanent safe contact. **Makes handling easier:** Quick, easy cable insertion thanks to funnel sleeve. **Increases your safety:** High thermal resistance up to 105 °C.

100 units as per DIN

C141

Order-No.		mm <sup>2</sup>	AWG		D1	L1	L2		
43968	red	0.5 - 1 mm <sup>2</sup>	22 - 16	6.3 x 0.8 mm	3.5	21	7.8	100	1
43969	blue	1.5 - 2.5 mm <sup>2</sup>	16 - 14	6.3 x 0.8 mm	4.3	21	7.8	100	1
43970	yellow	4 - 6 mm <sup>2</sup>	12 - 10	6.3 x 0.8 mm	6.2	23.8	7.8	50	1

Female blade connectors, fully insulated

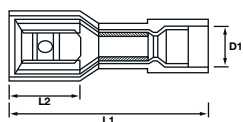

**Increases your process reliability:** Consistently high processing quality for permanent safe contact. **Makes handling easier:** Quick, easy cable insertion thanks to funnel sleeve. **Increases your safety:** High thermal resistance up to 105 °C. **Saves time:** No further insulation required after pressing.

100 units as per DIN

C146

Order-No.		mm <sup>2</sup>	AWG		D1	L1	L2		
43971	red	0.5 - 1 mm <sup>2</sup>	22 - 16	6.3 x 0.8 mm	3.5	21.5	6.8	100	1
43972	blue	1.5 - 2.5 mm <sup>2</sup>	16 - 14	6.3 x 0.8 mm	4.3	21.8	6.8	100	1
43973	yellow	4 - 6 mm <sup>2</sup>	12 - 10	6.3 x 0.8 mm	5.8	25	6.8	50	1

Male blade connectors, insulated

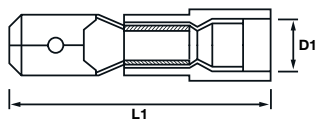

**Increases your process reliability:** Consistently high processing quality for permanent safe contact. **Makes handling easier:** Quick, easy cable insertion thanks to funnel sleeve. **Increases your safety:** High thermal resistance up to 105 °C.

100 units as per DIN

C161

Order-No.		mm <sup>2</sup>	AWG		D1	L1		
43974	red	0.5 - 1 mm <sup>2</sup>	22 - 16	6.3 x 0.8 mm	3.5	21.5	100	1
43975	blue	1.5 - 2.5 mm <sup>2</sup>	16 - 14	6.3 x 0.8 mm	4.3	21.3	100	1
43976	yellow	4 - 6 mm <sup>2</sup>	12 - 10	6.3 x 0.8 mm	6.2	24	50	1



Stripping/insulating / crimping



**Simplifies your work**

Torch with integrated laser makes it easier to fix positions more precisely and project measurements for ceiling installations, for example. Perfect light positioning thanks to lamp head swivelling in an L shape.

**Simplifies your work**

Comfortable measurement in different work positions thanks to the ingeniously positioned scales, even when viewed from above.

# Surveying/marketing/measuring/checking

## This is what we call precision work made to measure.

Wiha measurement and testing devices prove to be dependable helpers during electrical installation work. The multi-functional torch impresses in three ways thanks to its integrated laser, UV light and LED light with two lighting levels. With variable distance marks, the Wiha electrician's spirit level can reach across up to four flush boxes. Thanks to its ingeniously positioned scale, it allows users to make measurements effortlessly from different work positions. Users are guaranteed to see bubbles perfectly, even from a sharp angle. The Wiha electrician's folding ruler provides a scale for up to three flush boxes and edge distance marking at 150 mm. It can also be used to route cables into hard-to-reach installation locations. With its florescent coating, the folding ruler is also quick and easy to find in the dark with a UV light.

**"The Wiha spirit level is a big hit! I can see the bubbles perfectly even when taking measurements above my head. I can also mark out measurements without needing to take a break."**  
Ralf Kästle



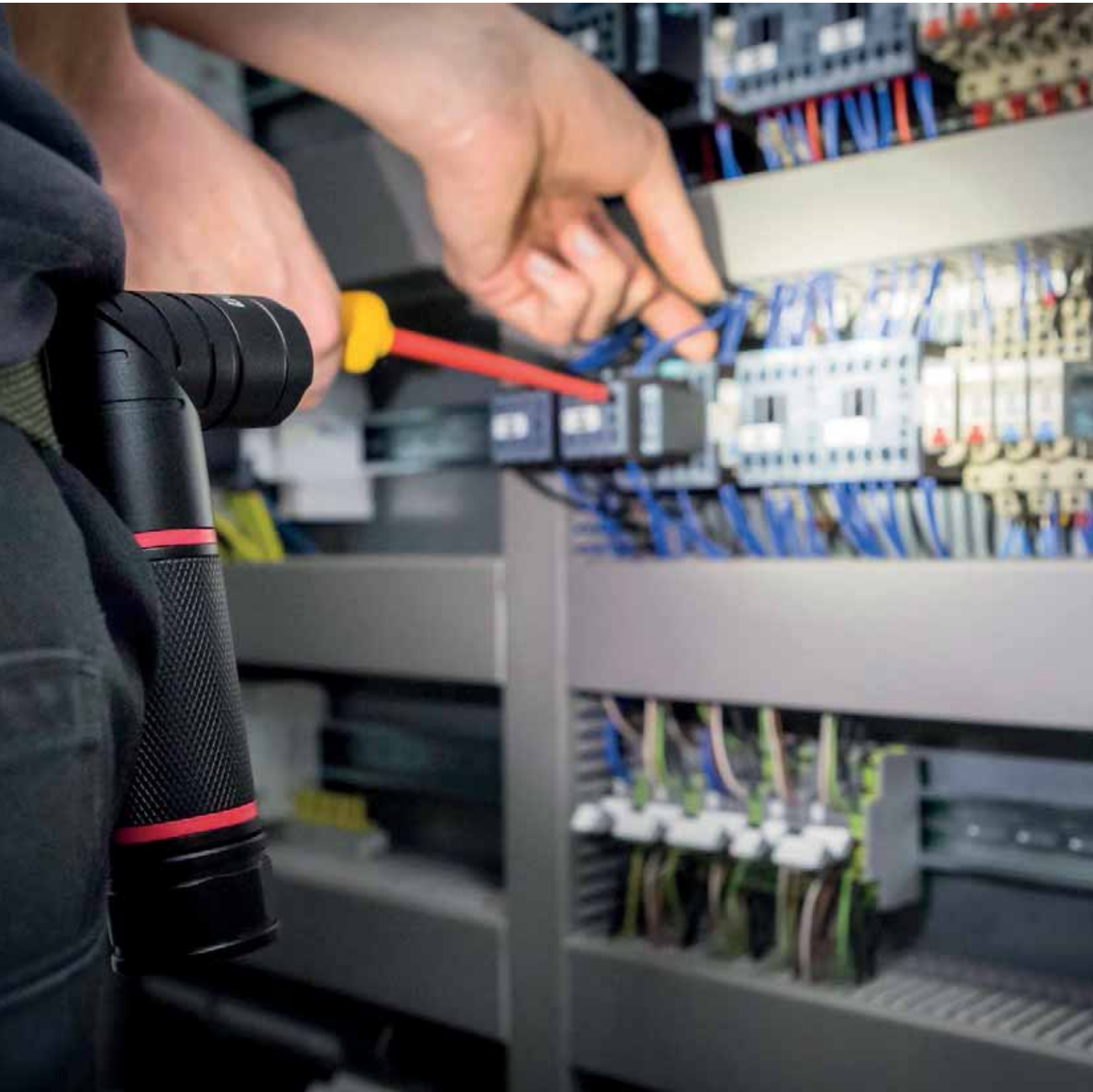

Even the most experienced professional tradesmen find it difficult to work efficiently in poorly lit work environments. The Wiha multi-functional torch sheds light on things in three ways: It features an integrated laser, UV light and LED light with two lighting levels. It is thus a compact, universal work tool which replaces several instruments in a single device. The integrated laser offers a great advantage, providing detailed positioning and easy transmission of measurements for tasks such as ceiling installations. This torch is even more practical for portable use thanks to the retaining clip, magnetic positioning and swivelling lamp head used to point the light in the required direction. Compact, light and multi-functional, the Wiha torch ensures optimum illumination for perfect vision and positioning.

- **Simplifies your work**  
Retaining clip and magnetic positioner on the lid allows you to keep hands free for other tasks.
- **Simplifies your work**  
Integrated laser makes it easier to fix position more precisely and project measurements for ceiling installations, for example. Perfect light positioning thanks to lamp head swivelling in an L shape.
- **Increases your efficiency**  
Very strong LED lamp – two light intensities to adjust to light conditions as required. Includes laser and UV light.
- **Increases your safety**  
Power-on time of 2 seconds prevents the laser being activated by accident.



## Flashlight with LED, laser and UV light



**Simplifies your work:** Retaining clip and magnetic positioner on the lid allows you to keep hands free for other tasks. **Simplifies your work:** Integrated laser makes it easier to fix position more precisely and project measurements for ceiling installations, for example. Perfect light positioning thanks to lamp head swivelling in an L shape. **Increases your efficiency:** Very strong LED lamp – two light intensities to adjust to light conditions as required. Includes laser and UV light. **Increases your safety:** Power-on time of 2 seconds prevents the laser being activated by accident.

in blister pack, including 3 AAA batteries

24670

Order-No.	LED		UV			
41286	100 - 310 lm	Class 2	390 - 400 nm	3x AAA batteries	x	5

### INFOBOX: Flashlight with LED, laser and UV light



#### Universal work tool with integrated laser, UV light and LED light.

- Optimum positioning and variable light direction thanks to the magnetic base and swivel head.
- The installation position can be projected directly from the middle of a table when fitting lights to the ceiling.
- The integrated UV light is ideal for finding misplaced coloured fluorescent Wiha tools and for technical inspections.



## Torque QuickCheck torque testing device set



**Increases your efficiency:** Fast, easy checking of your torque tool thanks to mobile, compact shape. **Increases your safety:** Checking your torque tool regularly guarantees safe, precise work with the correct torque. **Saves time:** LED traffic light system displays results in a way which is quick and easy to understand.



4 pcs. with adapter blades, batteries, and box

2909

Order-No.	Nm	SA%	SB	
42086	2.8	2	x	1

## INFOBOX: Torque QuickCheck



### Wiha Torque QuickCheck

- The Wiha torque screwdriver can quickly and easily test torque screwdrivers to check the precision of the configured torque value before each use.
- Checking tools regularly ensures reliable, precise work.
- The device offers user-friendly operation, clear test readings and easy to understand LED traffic light signals.
- Thanks to a compact, handy shape, it is the ideal companion when out on jobs.
- Suitable for all Torque Vario®-S and iTorque® torque screwdrivers whose torque range included 2.8 Nm.

Voltage and continuity tester eMobility 12 – 1,000 V AC, CAT IV



**Simplifies your work:** Illuminated LC display, LED scale and signal sound for easy to read measurement results. **Simplifies your work:** Quick one-hand testing on power sockets due to the 19 mm contact distance. **Increases your flexibility:** Two-pin voltage tester covers a large voltage range from 12 - 1,000 V AC, as well as 12 - 1,500 V DC.

incl. 2x AAA batteries 25515

Order-No.			V AC min-max	V DC min-max	
44319	282	2x AAA batteries	12 - 1000	12 - 1500	10

Single-pole, non-contact volt detector, 12–1,000 V AC



**Saves time:** Rapid voltage test thanks to contactless measuring. **Increases your efficiency:** Compatible for use in all sockets worldwide thanks to measurement tip suited to international usage. **Increases your efficiency:** Integrated powerful LED flashlight. **Increases your flexibility:** The voltage tester covers a large voltage range from 12 - 1,000 V AC.

Includes two AAA batteries 25513

Order-No.			V AC min-max	
43797	2x AAA batteries	28.5 150	12 - 1000	10

INFOBOX:  
Single pole voltage tester, 12 - 1,000 V AC

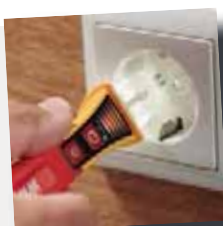

- Rapid voltage test thanks to contactless measuring.
- Internationally adjustable measuring tip for all outlets, globally applicable.
- Green illuminated LED indicates readiness.
- Complies with safety standards EN 61010-1 / IEC 61326 and measuring category CAT IV 1,000 VAC.
- Extensive voltage range from 12 - 1,000 V AC.
- The strength of the alternating electrical field is signalled by an acoustic and five-level LED scale.
- Integrated high-luminescence LED flashlight.

Single-pole, non-contact voltage tester volt detector, explosion protected 12-1,000 VAC



**Increases your efficiency:** Integrated powerful LED flashlight. **Saves time:** Rapid voltage test thanks to contactless measuring. **Increases your flexibility:** The voltage tester covers a large voltage range from 12 - 1,000 V AC. **Increases your efficiency:** Compatible for use in all sockets worldwide thanks to measurement tip suited to international usage.

incl. 2x AAA batteries 25513

Order-No.			V AC min-max	
44309	2x AAA batteries	28.5 150	12 - 1000	10

Single-pole, non-contact volt detector, 90–1,000 VAC



**Saves time:** Rapid voltage test thanks to contactless measuring. **Increases your efficiency:** Compatible for use in all sockets worldwide thanks to measurement tip suited to international usage.

Includes two AAA batteries 25514

Order-No.			V AC min-max	
43798	2x AAA batteries	28.5 150	90 - 1000	10

INFOBOX:  
Single pole voltage tester, 90 - 1,000 V AC



- Rapid voltage test thanks to contactless measuring.
- Internationally adjustable measuring tip for all outlets, globally applicable.
- Green illuminated LED indicates readiness.
- Complies with safety standards EN 61010-1 / IEC 61326 and measuring category CAT IV 1,000 VAC.
- Voltage range from 90 - 1,000 V AC.
- The voltage is visually indicated by an illuminated LED.

Voltage tester SoftFinish® single-pole, 110-250 volts



**Increases your efficiency:** Stable and as robust as a fully-fledged screwdriver. **Offers you full protection:** Each tool individually tested at 10,000 V AC and approved for 1,000 V AC.

Electrician's Longlife® folding ruler, 2 m



**Simplifies your work:** Integrated with cable retractor for cables between 3-7mm. **Increases your efficiency:** Ruler with integrated distance marks for up to 3 flush boxes. **Lowers your costs:** Ruler quick and easy to find – even in dark environments with a UV light. **Offers you full protection:** Tool tested at 10,000 V AC and suitable for 1.000 V AC.

Slotted transparent, with push-on clip

25511

Order-No.						
34745	3.0	60	0.5	140	19	10

metric, 10 segments

4102008

Order-No.				
42068	15	orange	135	10

Measuring tape 5 m



**Meets your requirements:** The auto-lock system keeps the measuring tape firmly fixed in every position. **Simplifies your work:** Measurement comfort thanks to the ergonomic shape and anti-slip material. **Makes handling easier:** A strong magnet at the end of the hook guarantees adhesion to all metal surfaces. **Saves time:** Quick and easy reading of the measurement value thanks to a robust, high-contrast steel measuring tape.

With belt clip

Order-No.				
33251	70	80	5000 x 19	1

Folding ruler LongLife Plus Composite 2 m



metric, 10 segments

4102005

Order-No.				
37067	15	red / black	124	10

Electrician's spirit level



**Simplifies your work:** Comfortable measurement in different work positions thanks to the ingeniously positioned scales, even when viewed from above. **Increases your efficiency:** Both bubbles can be seen easily even from an acute angle. **Saves space:** Perfectly portable. **Saves time:** Variable distance marks for up to 4 flush boxes.

40 cm

246

Order-No.				
42074	400	330	x	1



**Increases your efficiency**

Electrician's hammer offers perfect balance thanks to optimum weight distribution for effective handling.

**Saves time**

Dowel racket allows you to make dowel holes with the strike of a hammer anywhere at any time, even near power sockets.

**Increases your work quality**

The flat surface on the hammer handle ensures cables and dowels are fitted into position without causing any damage.

# Striking

## Optimum power transmission.

Specially tailored for use by electricians: Wiha impact tools. With optimally uniform weight distribution, the Wiha electric hammer strikes a perfect balance and is also eminently suitable for use in confined working environments. Its flat claws allow you to remove nails and nail clamps easily. The flat surface on the hammer handle ensures cables and dowels are fitted into position without causing any damage to the cable duct or plasterboard. Wiha's scaled impact screwdriver blade ensures that the portable dowel ratchet makes a perfectly dimensioned dowel hole to the required depth anywhere at any time and without making a mess, unlike power tools. The galvanic separation between the blade and solid steel cap ensures that the user is always protected, even if they accidentally hit a live wire.

**"Fits nicely into the hand and can be used in a variety of ways. It's now a permanent fixture in my toolbox!"**

Andreas Ebener





Thanks to its optimum balance, the electrician's hammer is perfectly sized in the hand while also providing a secure hold when hammering thanks to the ergonomically shaped hammer handle. With its U-shaped impact surface, the Wiha electrician's hammer delivers the optimum solution to working in corners and confined spaces. You can quickly and easily remove nails and nail clamps from walls with the flat claws on the hammer head. The flat surface on the hammer handle means cables and dowels are positioned effectively without causing any damage to the wall.

- **Simplifies your work**  
Flat claws allow you to remove nails and nail clamps easily.
- **Increases your efficiency**  
Perfect balance thanks to optimum weight distribution for effective handling.
- **Improved access**  
Perfectly suited for use in confined working environments thanks to the combination of a square and round head shape.
- **Increases your work quality**  
The flat surface on the hammer handle ensures cables and dowels are fitted into position without causing any damage.



## SoftFinish® dowel racket set with dowels



**Simplifies your work:** Dirt- and dust-free work compared to when machines are used. **Increases your efficiency:** Scaled impact screwdriver blade provides more detailed depth measurement. Perfectly dimensioned dowel hole thanks to blade adjusted to required size. **Protects your health:** Dowel hole can be made anywhere using a hammer at any time, even near power sockets. **Increases your safety:** Galvanic separation in the handle prevents a discharge between the striking cap and the blade. **Saves time:** Hammer dowel holes anywhere at any time without worrying how near you are to wall sockets.

with 6 mm round blade pack, 5-pcs.

SB534S5

Order-No.			
41289	x	1	
	1 x Dowel racket		
	2 x 30 mm dowel / 2 x 40 mm dowel		

## Electrician's hammer



**Simplifies your work:** Flat claws allow you to remove nails and nail clamps easily. **Increases your efficiency:** Perfect balance thanks to optimum weight distribution for effective handling. **Improved access:** Perfectly suited for use in confined working environments thanks to the combination of a square and round head shape. **Increases the quality of your work:** The flat surface on the hammer handle ensures cables and dowels are fitted into position without causing any damage.

with 300 g hammer head, in blister pack

846

Order-No.					
42071	23.9	283	500	x	4

 INFOBOX:  
 SoftFinish® dowel racket set with dowels

- Makes it easier to insert dowels and saves valuable working time.
- Ensures dirt- and dust-free work compared to machines.
- Galvanic separation between the blade and solid steel cap protects against electric shock.
- Perfect for portable use since you can make dowel holes anywhere at any time at the strike of a hammer.

 INFOBOX:  
 Electrician's hammer

- With its optimally uniform weight distribution, this hammer ensures perfect balance, delivering impact and fatigue-free work.
- Its flat claws make it easier to remove fastening components such as nail clamps, even from difficult-to-access spots.
- Optimum access into corners and confined spaces thanks to U-shaped striking surface.
- The flat hammer handle lower surface acts as a soft-faced hammer, ensuring components such as cables and dowels are fixed into position without causing damage.

## Soft-faced hammer set "Safety"



**Meets your requirements:** Hammer components in a practical Wiha safety set with replaceable hammer heads of various degrees of hardness for all applications. **Simplifies your work:** Makes work easier, optimum impact effect and less effort needed. **Lowers your costs:** Each hammer component is available individually as a spare part.

## with assorted hammer faces, 9-pcs. in box

832B801

Order-No.



44008

1

1 x Soft-faced hammer „Safety“ medium soft/hard with hickory wooden handle, round hammer face

1 x Face soft round for soft-faced hammer „safety“

1 x Face medium-soft round for soft-faced hammer „safety“

2 x Face medium-hard round for soft-faced hammer „safety“

1 x Face hard round for soft-faced hammer „safety“

1 x Face very hard round for soft-faced hammer „safety“

1 x L-keys Hexagonal ball end matt chrome-plated

1 x Metal Box

GS tested.

# Wiha Order number register

Order no.	Page	Order no.	Page	Order no.	Page	Order no.	Page
<b>00</b>		00867	69	<b>05</b>		<b>25</b>	
00684	76	00868	69	05301	90	25477	67
00685	76	00877	68	05302	90	25739	90
00686	76	00878	68	05303	90	25740	90
00687	76	00879	68	05799	88	25741	90
00689	76	00880	68	05800	88	25742	90
00690	76	00881	68	<b>06</b>		<b>26</b>	
00691	76	00882	68	06637	90	26000	90
00692	76	<b>01</b>		06638	90	26002	90
00694	76	01790	88	06639	90	26625	39
00695	76	01791	88	06888	88	26626	39
00696	76	01792	88	06889	88	26627	39
00697	76	01793	88	<b>20</b>		26705	113, 119
00698	76	01794	88	20218	89	26708	113, 119
00700	76	01795	88	20219	89	26711	113, 119
00701	76	01796	88	20220	89	26714	113, 119
00702	76	01798	88	20221	89	26717	113, 119
00703	76	01799	88	20222	89	26720	113, 119
00704	76	01800	88	20223	89	26727	113, 119
00706	76	01803	88	20224	89	26728	113, 119
00707	76	01805	88	<b>21</b>		26729	113, 119
00708	76	01808	88	21045	89	26732	120
00709	76	01809	88	21047	89	26735	120
00711	76	01811	88	<b>22</b>		26745	131
00712	76	01812	88	22509	88	26755	21
00713	76	01913	87	22510	88	26847	131
00819	68	<b>02</b>		22511	88	26852	118
00820	68	02292	96	22512	88	26864	39
00821	68	<b>03</b>		22596	90	26931	76
00822	68	03223	75	22597	90	<b>27</b>	
00823	68	03224	75	22598	90	27753	76
00824	68	03225	75	22599	90	27754	76
00825	68	03226	75	22600	90	27755	76
00826	68	03228	75	<b>23</b>		27928	71
00827	68	03230	75	23145	90	27929	71
00828	68	03231	75	23147	90	27930	71
00829	68	03232	75	23149	90	27931	71
00830	68	03237	75	23151	90	27932	71
00831	68	03238	75	23195	90	27933	71
00832	68	03239	75	23197	90	27934	71
00833	67	03245	75	23199	90	27935	71
00834	67	03246	75	23201	90	<b>28</b>	
00846	68	03247	75	23203	90	28481	90
00847	68	03760	68	23205	90	28691	49
00848	68	03761	68	23207	90	<b>29</b>	
00849	68	03762	68	23209	90	29416	86
00850	68	03988	71	23211	90	29417	86
00853	69	<b>04</b>		23213	88	29466	69
00855	69	04009	88	23215	88	<b>30</b>	
00856	69	04010	88	23217	88	30361	68
00857	69	04059	88	23219	88	30362	68
00858	69	04126	88	23221	88	30363	68
00859	69	04127	88	23223	88	30364	68
00860	69	04176	88	23225	88	30365	68
00861	69	04194	90	23226	88	30366	68
00862	69	04195	90	23227	88	30700	68
00863	69	04196	90	23228	88	30701	68
00864	69	04197	90	<b>24</b>		30715	68
00865	69	04198	90	24867	89	30716	68
00866	69						

Order no.	Page	Order no.	Page	Order no.	Page	Order no.	Page
<b>31</b>		33709	89	34555	90	35508	46, 61
31863	68	33710	89	34556	90	35509	46, 61
31957	88	33711	89	34557	90	35510	46, 61
31958	88	33712	89	34558	90	35511	46, 61
31959	88	33713	89	34559	90	35861	137
31960	88	33714	89	34560	90	35862	137
31961	88	33715	89	34578	46, 61	35870	47
31962	88	33716	89	34579	46, 61	<b>36</b>	
<b>32</b>		33717	89	34580	46, 61	36053	134
32105	88	33718	89	34581	46, 61	36071	46, 61
32299	89	33719	89	34582	46, 61	36092	87
32302	89	33720	89	34583	46, 61	36093	87
32303	89	33721	89	34584	46, 61	36094	87
32304	89	33722	89	34585	46, 61	36114	75
32305	89	33723	89	34586	46, 61	36189	114
32306	89	33724	89	34587	46, 61	36327	89
32307	89	33725	89	34588	46	36329	66
32308	89	33726	89	34589	46, 61	36330	66
32309	89	33727	89	34590	46, 61	36389	22
32310	87	33728	89	34688	125	36455	65
32383	76	33729	89	34689	125	36536	66
32384	76	33730	89	34690	125	36537	66
32396	68	33731	89	34691	125	36538	66
32397	68	33732	89	34692	125	36539	66
32399	76	33738	77	34693	125	36540	66
32400	76	33741	77	34694	125	36541	66
32410	89	33744	77	34695	125	36542	66
32411	89	33746	77	34696	125	36558	65
32412	89	33841	135	34697	125	36791	36
32413	89	33842	135	34698	125	<b>37</b>	
32414	89	33843	135	34699	125	37067	157
32415	89	33920	89	34700	125	37147	46, 61
32416	89	33921	89	34701	125	37222	46, 61
32417	89	33922	89	34702	125	37223	46, 61
32418	89	33923	89	34703	125	37224	46, 61
32419	89	33924	89	34704	125	37225	46, 61
32421	89	33925	89	34705	125	37226	46, 61
32423	89	33926	89	34706	125	37227	46, 61
32477	87	33927	89	34707	125	37402	114
32490	88	33928	89	34708	124	37403	114
32491	88	33929	89	34745	157	37450	120
32492	88	33930	89	<b>35</b>		<b>38</b>	
32493	88	33931	89	35389	65	38020	21
32494	88	33932	89	35390	66	38074	39
32495	88	33961	88	35391	66	38191	110
32496	88	33962	88	35392	66	38362	65
32497	88	33963	88	35393	66	38370	89
32686	88	33964	88	35394	66	38371	89
32687	88	33965	88	35395	66	38372	89
32688	88	33966	88	35396	66	38552	111, 130
32689	88	33969	20	35446	66	38605	77
<b>33</b>		<b>34</b>		35456	88	38606	77
33251	157	34306	87	35457	88	38612	52
33520	120	34452	89	35501	66	38613	52
33703	88	34453	89	35502	66	38798	134
33704	88	34454	89	35503	66	38918	48
33705	88	34455	89	35504	66	38919	48
33706	88	34456	89	35505	66	38920	48
33707	88	34457	89	35506	46, 61	38921	48
33708	88	34554	90	35507	46, 61	38925	48

# Wiha Order number register

Order no.	Page	Order no.	Page	Order no.	Page	Order no.	Page
38926	48	41232	55	42989	70	43088	47, 73
38927	48	41233	55	<b>43</b>		43089	47, 73
38928	48	41235	52	43022	25	43090	47, 73
38929	48	41241	22	43023	24	43091	47, 73
38930	48	41246	136	43024	24	43092	47, 73
38931	48	41274	112	43025	25	43093	47, 73
38932	48	41279	112	43026	72	43094	47, 73
38933	48	41286	154	43027	72	43095	47, 73
38934	48	41289	162	43028	72	43096	47, 73
38935	48	41341	42	43029	72	43097	47, 73
38936	48	41342	42	43030	72	43098	47, 73
<b>39</b>		41343	42	43031	72	43099	47, 73
39041	86	41344	42	43032	72	43100	74
39045	87	41345	42	43033	72	43101	74
39049	86	41476	42	43034	72	43102	74
39056	87	41477	42	43035	72	43103	74
39057	87	41478	42	43036	72	43104	74
39059	87	41479	42	43037	72	43105	74
39060	86	41824	83	43038	72	43106	74
39083	86	41825	83	43039	72	43107	74
39134	87	41826	83	43040	72	43108	74
39178	90	41827	85	43041	72	43109	74
39179	90	41828	85	43042	72	43110	74
39180	90	41829	85	43043	72	43111	74
39181	90	41830	82	43044	72	43112	74
39182	90	41831	82	43052	73	43113	74
39183	90	41832	84	43053	73	43114	46, 61
39184	89	41833	84	43054	73	43115	46, 61
39185	89	41834	84	43055	74	43116	46, 61
39186	89	41914	32	43056	74	43117	46, 61
39187	89	41915	32	43057	74	43125	114
39188	89	41923	114	43058	74	43126	38
39189	89	41979	94	43059	74	43128	47
39190	89	<b>42</b>		43060	74	43139	62
39191	89	42062	134	43061	72	43140	46, 61
39192	89	42068	157	43062	72	43141	46, 61
39193	89	42071	162	43063	72	43142	46, 61
39194	89	42074	157	43065	73	43143	46, 61
39206	90	42086	41, 155	43066	73	43144	46, 61
39207	90	42098	81	43067	73	43145	46, 61
39208	90	42099	80	43068	73	43146	46, 61
<b>40</b>		42114	80	43069	73	43147	46, 61
40342	135	42115	80	43070	73	43148	46, 61
40523	17	42116	80	43071	73	43149	46, 61
40674	37	42117	80	43072	73	43150	46, 61
40921	112	42118	80	43073	73	43151	46, 61
<b>41</b>		42135	81	43074	73	43152	44, 59
41003	64	42136	81	43075	73	43153	44, 59
41141	66	42137	81	43076	73	43154	44, 59
41142	66	42138	81	43077	73	43155	44, 59
41143	66	42139	81	43078	73	43156	44, 59
41144	66	42162	134	43079	73	43157	44, 59
41145	66	42374	70	43080	73	43158	44, 59
41146	66	42375	70	43081	73	43159	44, 59
41147	66	42376	70	43082	73	43160	33, 44, 59
41158	52	42377	70	43083	73	43161	43, 58
41159	46, 61	42378	70	43084	73	43162	43, 58
41160	46, 61	42379	70	43085	73	43163	45, 60
41230	57	42380	70	43086	73	43164	45, 60
41231	54	42471	70	43087	73	43167	57





Order no.	Page	Order no.	Page
43177	48	43961	146
43292	62	43962	146
43326	112	43963	146
43335	112	43964	146
43340	112	43965	147
43449	57	43966	147
43465	19	43967	147
43466	38	43968	147
43467	56	43969	147
43474	20	43970	147
43660	112	43971	148
43662	112	43972	148
43797	156	43973	148
43798	156	43974	148
43847	96	43975	148
43848	97	43976	148
43851	94, 95	43982	138
43879	18	43984	138
43899	141	43985	139
43900	141	43987	139
43903	141	43995	139
43904	141	43996	142
43905	141	<b>44</b>	
43907	141	44001	75
43908	142	44005	140
43909	142	44007	140
43910	142	44008	163
43911	142	44106	33, 45, 60
43912	142	44107	33, 45, 60
43913	142	44128	15
43915	142	44163	38
43916	142	44240	132
43917	142	44241	133
43918	142	44242	132
43919	142	44309	156
43927	142	44314	121
43928	142	44318	30
43932	142	44319	156
43933	142	44351	30
43934	142	44355	74
43935	144	44363	32
43936	144	44364	32
43937	144	44366	33, 44, 59
43938	144	44367	31
43939	144	44385	46, 61
43940	144	44574	23
43941	144	44617	133
43942	144	44619	132
43947	144	44620	132
43948	144	44661	102
43951	144	44664	104
43952	144	44665	102
43953	144	44684	101
43954	146	44685	100
43955	146	44753	103
43956	146	<b>45</b>	
43957	146	45223	136
43958	146	45244	103
43959	146	45292	77
43960	146	45296	53

# Wiha Article number register



Article no.	Page	Article no.	Page	Article no.	Page	Article no.	Page
<b>2</b>		320N	68	7148	87	<b>SB</b>	
2270P	70	320NK6	67	7148CS	87	SB28310101	57
2270PK601	70	320NK7	67	7207NEX	74	SB28310301	57
2271P	70	320NZK6SO	67	7207NHS	74	SB28310401	57
246	157	3211	66	7207NK2001	24	SB283109020	52
246176	114	321N	68	7207NRW	73	SB283109021	52
24618T	72	322	69	7207NS	73	SB283109022	52
24628	87	322K5	69	7208NEX	74	SB283109023	52
24667	75	323N	68	7208NHS	74	SB283109040	53
24670	154	324	68	7208NK2001	24	SB2831B001	44, 59
24678	134	3241	66	7208NS	73	SB2831B501	44, 59
24680	134	325	68	7209NEX	31, 74	SB2831B502	44, 59
24682	75	3251	66	7209NHS	74	SB2831B601	44, 59
25511	157	3251K6	65	7209NK2001	25	SB2831B801	44, 59
25513	156	3251TR	66	7209NK2002	19	SB2831B900	44, 59
25514	156	327	68	7209NK2003	38	SB2831B901	44, 59
25515	156	3271	66	7209NK2004	56	SB2831B902	44, 59
2822	38	328	68	7209NRW	20	SB2831B903	33, 44, 59
2831	62	3281	66	7209NS	47, 73	SB2831B904	33, 44, 59
283110	46, 61	33394	101	7947905	86	SB2831B950	43, 58
283111	46, 61	33397	100	7947995	87	SB2831B951	43, 58
283112	46, 61	334N	71	7948005	86	SB2831B991	45, 60
283113	46, 61	336N	71	7948927	86	SB2831B992	45, 60
283114	46, 61	358N	68	<b>8</b>		SB2831PB900	33, 45, 60
283115	46, 61	369RE9F	94	832B801	163	SB2831PB901	33, 45, 60
283116	46, 61	<b>4</b>		846	162	SB369H9	96
283117	46, 61	40511	97	<b>9</b>		SB369RH901	95
283118	46, 61	4102005	157	9300018	20	SB380101	77
2831T18	54	4102008	157	9300025	22	SB380102	77
2831T901	55	<b>5</b>		9300031	21	SB380103	77
2831T902	55	530	75	9300035	22	SB380104	77
283793	48	531	75	9300040	18	SB380302020	77
283794	48	532	75	93001001	139	SB380302021	77
283795	48	5590N	72	93001003	139	SB3803050	77
283799	74	5590NA	72	93001011	138	SB534S5	162
2859	39	5590NT20	25	93001013	138	SB7945TY202	81
2872	39	590T401	30	93001911R	139	SB7945TY303	81
2872T13	37	591T101	30	930050005	23	SB7945TY505	81
2872T18	36	599001	32	930070103	15	SB7945TY903	81
28799	47	599002	32	9300702	17	SB7945TY904	81
2899	49	599006	32	<b>C</b>		SB7945TY905	81
2909	41, 155	599007	32	C000A	142	SB7946TY202	80
2933	48	<b>7</b>		C000A100	141	SB7946TY303	80
2970	42	7040ZL	88	C000A400	141	SB7946TY505	80
29701080S4	42	7041Z	88	C000AVH	140	SB7946TY903	80
29701200S4	42	7042Z	88	C000C100	141	SB7946TY904	80
29701280S4	42	7043Z	90	C000C400	141	SB7946TY905	80
29701S5	42	7043ZR	90	C000CVH	140	SB7947005	86
<b>3</b>		7045BE	89	C001A	144	SB7947505	87
302	76	7045R	89	C001A200	141	SB7947505TR	87
3022	76	7045Z	89	C001C200	141	SB7947902	87
303190	102	7045ZH	89	C020	146	SB7947904	86
30390	104	7046Z	90	C040	146	SB7947999	86
30391	102	7047ZR	90	C101	147	SB7947T303	83
30396	103	7048Z	90	C141	147	SB7947T906	83
3201	66	7049PHM	88	C146	148	SB7947T999	83
3201K12	64	7049PZM	88	C161	148	SB7947Y202	85
3201K6	65	7049ZOTTS	90			SB7947Y505	85
3201K601	65	7143	87			SB7947Y904	85
3201ZK6	65						

Article no.	Page
SB7948T950	82
SB7948T999	82
SB7948Y505	84
SB7948Y904	84
SB7948Y950	84
<b>X</b>	
XX2872S3	39
<b>Z</b>	
Z 01 0 06	113, 119
Z 02 0 06	113, 119
Z 05 0 06	113, 119
Z 05 1 06	113, 119
Z 07 0 06	120
Z 09 0 06	120
Z 12 1 06	112
Z 14 0 06	131
Z 14 1 06	111, 130
Z 15 0 01	114
Z 16 3 06	112
Z 18 0 06	110
Z 21 0 06	120
Z 22 0 06	120
Z 25 0 06	121
Z 33 4 01	125
Z 33 5 01	125
Z 34 4 01	125
Z 34 5 01	125
Z 44 3 01	114
Z 50 3 06	112
Z 55 0 06	131
Z 57 0 06	134
Z 57 5 06	133
Z 60 0 06	137
Z 62 0 06	135, 136
Z 71 7 06	114
Z 72 0 06	132
Z 73 0 06	132
Z 73 2 06	133
Z 74 0 06	132
Z57000106K	134
Z99000106	118
Z99000206	21
Z99000701	124

# Overview of torque tools

Tools	Precision	Setting	Special feature	Nm range	Torque range				
					0,01 Nm	0,1 Nm	1 Nm	10 Nm	20 Nm
<b>easyTorque adapter</b> 	± 10%	fixed	VDE certification Permanently preset in factory	5 versions 0,8 – 4,0					
<b>TorqueVario®-S VDE</b> 	± 6%	variable	VDE certification Numeric scale	0,5 – 2,0					
				0,8 – 5,0					
<b>TorqueVario®-S T electric</b> 		variable	VDE certification Numeric scale	2,0 – 7,0					
<b>Torque key, electric</b> 	± 4 %	variable	VDE certification Numeric scale	5 – 14					
				5-25					

## The cutting capacities for our pliers.

Soft wire Plastic, copper, aluminium electrical cable, electrical cable, silver wire					Medium-hard wire Iron nails, brass screws, wire-mesh fencing				
1	2	3	4	5	6	7	8	9	10
Diagonal cutters for plastic 					Precision mechanic's diagonal cutters 				

Interchangeable blades

slimBits  
Series 2831

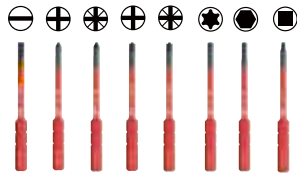

Series 28379



Series 7207 (3/8")  
Series 7209 (1/4")



Hard wire

Screws, wire rope, wire basket, electric rail

Hardened spring steel

Springs, hardened pins, chains

11

12

13

14

15

16

17

18

19

20

21

TriCut installation pliers

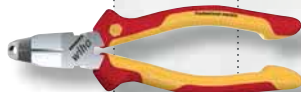

Electrician's diagonal cutters

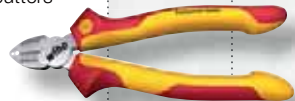

Combination pliers



Diagonal cutters



Heavy-duty diagonal cutters



BiCut® Diagonal cutters  
100 % /

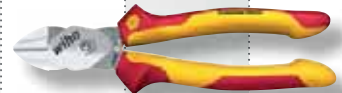





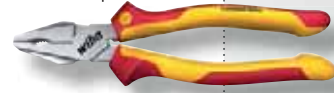























200 %

High-leverage  
combination pliers









# Legend



















## Drives

	Triangular nut
	Hexagon head
	Square nut
	Internal hexagon
	Internal hexagon with drill hole (tamper-resistant)
	Tamper Resistant hex
	Countersink
	Combination drill bit
	Pentalobe PL
	Y-type
	Phillips PH (cross-recessed)
	Pozidriv PZ (Phillips)
	Internal square
	Round tip
	Slotted
	Slotted nut
	SIT
	Spanner
	Twist drill
	Sliding sleeve
	Torq-Set®
	TORX®
	TORX® with drill hole (tamper-resistant)
	TORX PLUS®
	Tri-Wing®
	Multitooth
	Square reaming blade
	Xeno SL/PZ









## Drives

	Square nut
	Square
	G7 drive system
	Threaded connector
	SDS-Plus®
	Square nut



## Screwdrivers [mm]

	Cut width
	Tip width
	Round blade dimension
	Hex blade
	Hex bolster
	Scraper width
	Clip opening
	Tip width
	Head width, nut driver
	Blade length
	Shaft lengths
	Handle length
	Handle diameter
	Torque T-handle length
	Torque T-handle width
	Max. torque value [Nm]
	Max. torque value [in.lbs]
	Accuracy [%]
	Cable key depth























## L-keys [mm]

	Round blade dimension
	Hex blade
	Hex bolster
	Shaft lengths
	Blade length
	Side driver length T-handle
	Handle width
	Diameter





## Bits [mm]

	Threaded connector
	Drill working length
	Screw size



## Pliers [mm]

	Flat jaws
	Half round jaws
	Round jaws
	Cutter without bevel
	Cutter with small bevel
	Cutter with bevel
	Anvil cutter
	Center cutter
	Scissors cutter
	Front cutting edge in stripping pliers
	Max. diameter
	Max. cross-section
	Max. gripper pipe diameter
	Max. gripper width across flats
	External retaining ring
	Internal retaining ring
	Clamping range
	Opening width flat
	Cutting force
	with opening spring
	AWG American Wire Gauge
	Saw blade length



## Measurement tools [mm]

	Width of segments
	Colour
	Measurement capacity [mm]
	Measurement capacity in Inch

## Electro

	Battery
	LED LED lumens
	Laser light

## Soft faced hammer [mm]

	Face diameter
	Hammer face width
	Hammer head width

## General symbols

	Weight g
	Diameter
	Blister packed
	Total length
	Total length inch
	Packaging unit

# Legend

## Ranges



Case strength



Wheel-along case



Case shape



Case suitable for transport by air

## Electro



Torque safety check



Saves time

## Screwdrivers



MagicRing®



MagicSpring®



Ball end can swivel up to 25°



slimTECHNOLOGY

## Torque



Accuracy ±6%



Accuracy ±10%



slimTECHNOLOGY

## L-keys



MagicRing®



MagicSpring®



Ball end can swivel up to 25°



TORX® ball end; can swivel up to 25°



Visible in UV light



95° Stubby

## Bits



Suitable for impact screwdrivers



Lifespan 120 times longer



Visible in UV light

## Pliers



Cutting-to-length diameter



Skinning diameter length



Automatic skinning



DynamicJoint®



Heavy-duty diagonal cutters



OptiGrip



MagicTips®



BiCut® Power



TriCut®

## Impact tools



Optimum weight distribution



Soft hammer end



Levers out nail clamp

## Measurement tool



Fully enclosed



Visible from just 10°



Visible in UV light

## General information



Recommended for electricians – non-insulated



VDE-tested and certified



CE marking



ESD electronics mark

Subject to technical changes. All illustrations and graphics, specified dimensions and values and references to standards, e.g. DIN/EN, are non-binding. Any liability claims based on this will therefore be rejected. No liability claims will be accepted for printing errors and mistakes which have occurred during the production of the catalogue. All property rights to the catalogue held by Wiha Werkzeuge GmbH are reserved. The printing or copying of the texts and illustrations contained in this catalogue or its design is prohibited. Our General Terms and Conditions (Terms of Sale, Delivery and Payment) apply. You will find our general terms and conditions at [www.wiha.com](http://www.wiha.com)

**Wiha Werkzeuge GmbH**

**Obertalstraße 3-7**

78136 Schonach/Germany  
Phone +49 77 22 959 0  
Fax +49 77 22 959 159 Inland  
Fax +49 77 22 959 155 Export  
info.de@wiha.com  
www.wiha.com

**Wiha Tools Ltd.**

841 Birchwood Boulevard  
Warrington  
WA3 7QU  
Phone +44 15 27575 758  
+44 15 27910 986  
Fax +44 15 27910 023  
info.uk@wiha.com  
www.wiha.com/en

**Wiha France SARL**

Z. A. de Terrefort  
33520 Bruges/France  
Phone +33 55 6167 935  
Fax +33 55 6167 936  
servicecommercial@wiha.fr  
www.wiha.com/fr

**Wiha Nordic A/S**

Korskildelund 6  
2670 Greve/Denmark  
Phone +45 70 238 045  
info.nordic@wiha.com  
www.wiha.com

**WIHA IBERIA / Willi Hahn S.A.**

Avda. Sant Julia, 1  
Edificio Tilma oficina 17  
08400 Granollers / Barcelona / Spain  
Iberia@wiha.com  
Tel. +34 916938 511  
www.wiha.com/es

**Wiha Polska Sp. z o.o.**

ul. Budowlanych 10b  
80-298 Gdańsk/Poland  
Phone +48 58 7623 830  
Fax +48 58 7623 900  
info.pl@wiha.com  
www.wiha.com/pl

**Wiha in Russia**

Phone +48 58 7623 830  
Fax +48 58 7623 900  
michal.moczyński@wiha.com  
www.wiha.com

**Willi Hahn Corp.**

1348, Dundas Circle  
Monticello, MN 55362/USA  
Phone +1 76 32956 591  
Fax +1 76 32956 598  
cservice@wihatools.com  
www.wihatools.com

**Wiha Tools Canada Ltd.**

394 Deerhurst Drive  
L6T 5H9, Brampton, ON  
Phone +1 86 64940 096  
Fax +1 80 04947 456  
info@wihatools.ca  
www.wihatools.ca

**Wiha Tools (Shanghai) Co.Ltd.**

Tony Lv  
Room No. 908 - 910, Building 10,  
Long 2777, East Jinxiu Road,  
Pudong New District Shanghai,  
China 201206  
Phone +86 21 64401 119  
Fax +86 21 64401 112  
info.cn@wiha.com.cn  
www.wiha.com.cn

**Wiha Finland Oy**

Mäkituvantie 9  
FI-01510 Vantaa Finland  
Phone +358 44 231 9988  
raija.heliin@wiha.com  
www.wiha.com

**Wiha en Belgique**

Phone +32 49 3505 450  
info.belux@wiha.com  
www.wiha.com

**Wiha in Nederland**

Phone +31 64 6311 330  
info.nl@wiha.com  
www.wiha.com/nl

**Wiha in Italia**

Thoelke Rappresentanze Srl  
Phone +39 03 32966 039  
info.it@wiha.com  
www.wiha.com/it

**Premium Tools Australia Pty Ltd.**

PO Box 63  
Bargo, NSW 2574  
Phone +61 02 46841 460  
Fax +61 02 80887 272  
sales@wiha.com.au  
www.wiha.com.au

**Premium Tools (NZ) Ltd.**

Unit 5C 89 Ellice Road  
Wairau Valley  
Auckland, New Zealand  
Phone +64 09 4442 560  
Fax +64 09 3550 411  
sales@wiha.co.nz  
www.wiha.co.nz