

Climar
L I G H T I N G

essential
light for your
daily life

ESSENCE

climarlighting.com

essential light for your daily life

follow us



ESSENCE

GENERAL INDEX

DECOR HOME



TETRA-C
Suspended

008



KINA
Surface

010



KUBA
Surface

012

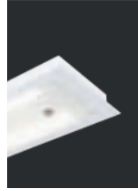

VITA
Surface

014



ROYAL-R
Surface

016



ROYAL-C
Surface

018



ONDATEC
Surface

020



ROYAL
Wall

022

OFFICE



ADAS OPAL
Surface

026



ADAS E60
Surface

028



OFFICE-R OPAL
Recessed

030



OFFICE-R E60
Recessed

032



OFFICE PANEL
Recessed

034

ACRYLIC



ATA
Surface

038

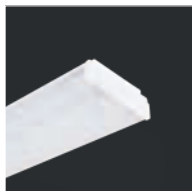

ACDE
Surface

040



CANTHOR
Surface

042



ACO
Corner Surface

044

DOWNLIGHTS

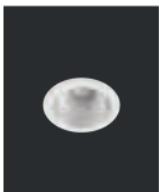

SIRIUS
120, 170, 225
Recessed

048

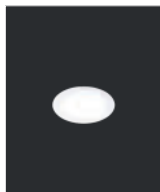

SIRIUS-D
137 IP44
Recessed

050

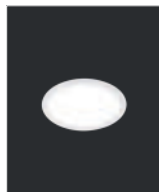

SIRIUS-D
187 IP44
Recessed

052

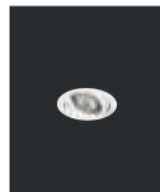

SIRIUS-R
184 RO
Adjust. Recessed

054

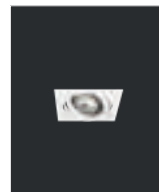

SIRIUS-R
SQ SINGLE
Adjust. Recessed

056



SIRIUS-R
SQ DUO
Adjust. Recessed

058



SIRIUS-R R111
RO, SQ
Adjust. Recessed

060

MINI PROFILES



NANO-S17
IP40, IP65
Surface

064



NANO CORNER
IP40, IP65
Surface

072



NANO-R14
IP40, IP65
Recessed

080



NANO-T14
IP40, IP65
Trimless

088

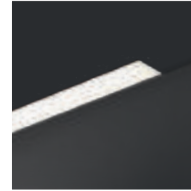

NANO EDGE
IP40, IP65
Trimless

098

TUBULAR



TUPOLI 70 IP40
Suspended
Surface

110

WATERPROOF



TUPOLI 70
IP65, IP66
Suspended/Surface

116



ATE BASIC
IP65, IP66, IK10
Surface

120

PLAFONIERS



ATAC
Surface

134

BATTEN AND INDUSTRIAL



SLIM
Surface

138



SLIM IP40
Surface

140



SLIM T5
Surface

142



AIN REFLECTOR
Surface

144



AIN IP40 REFLECTOR
Surface

148

OTHER APPLICATIONS

VANDALPROOF



AAV IK10
Corner Surface

154

HOSPITAL



ASH
Wall

156

SCHOOL



BLACKBOARD
Suspended
Wall

160

LED STRIPS

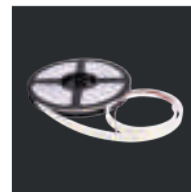

LED FLEX IP20, IP65
Surface

166



**DRIVERS AND
PROFILES**

170



ESSENCE LIGHTING

INDEX ESSENCE

DECOR HOME

pag. 006

OFFICE

pag. 024

ACRYLIC

pag. 036

DOWNLIGHTS

pag. 046

MINI PROFILES

pag. 062

TUBULAR

pag. 108

WATERPROOF

pag. 114

PLAFONIERS

pag. 132

BATTEN AND INDUSTRIAL

pag. 136

VANDALPROOF

pag. 156

HOSPITAL

pag. 158

SCHOOL

pag. 162

LED STRIPS

pag. 166



DECOR HOME



TETRA-C
SUSPENDED

KINA
SUSPENDED

KUBA
SUSPENDED

VITA
SURFACE

ROYAL-R
SURFACE

ROYAL-C
SURFACE

ONDATEC
SURFACE

ROYAL
WALL



TETRA-C SUSPENDED



PT

- Luminária para aplicações de iluminação geral em interiores.
- De aplicação suspensa por cabos de aço inox com ajuste rápido da altura.
- Corpo em alumínio disponível em dois acabamentos standard – branco ou cinza.
- Instalação rápida sem necessidade de abertura da luminária.
- Disponível em dois comprimentos para funcionamento com tubos LED T8 (não incluídos).

EN

- Luminaire suitable for general interior lighting.
- Suspended luminaire with stainless steel suspension with integrated tool-less height adjustment.
- Aluminium body available in two standard finishes – white or grey.
- Quick installation without the need to open the luminaire.
- Available in two lengths for use with T8 LED tubes (not included).

QUICK INFO

GENERAL

Suspended
IP20
960°C
Class I
Ta= -20°C +35°C

LIGHT SOURCE

LED Tubes (T8 G13)

ELECTRICAL SYSTEM

220-240V/50-60Hz
ON/OFF

FINISHING

RAL 9016 White
RAL 9006 Grey

TETRA-C SUSPENDED

WHITE FINISHING

c (mm)	Tubes	Power (W)	Output (lm)	Scheme A	Scheme C
996	2	2x14 MAX	3319 ⁽¹⁾	33.06.40.340002	33.06.40.340006
1301	2	2x22 MAX	5268 ⁽²⁾	33.06.40.340004	33.06.40.340008

GREY FINISHING

c (mm)	Tubes	Power (W)	Output (lm)	Scheme A	Scheme C
996	2	2x14 MAX	3319 ⁽¹⁾	33.06.40.340003	33.06.40.340007
1301	2	2x22 MAX	5268 ⁽²⁾	33.06.40.340005	33.06.40.340009

COMPONENTS



SUSPENSION SYSTEM (2pcs)

TYPE	1m	3m
Matt White	35.42.002.01.62	35.42.002.01.63



SURFACE CEILING CUP (1pc)

TYPE	1m	3m
Matt White Ø62x36 mm	35.06.40.003754	35.06.40.003755



RECESSED CEILING CUP (1pc)

TYPE	1m	3m
Matt White Ø80 mm	35.06.40.003756	35.06.40.003757

LED TUBE (T8 G13) NOT INCLUDED

- ⁽¹⁾ PHILIPS G13 900mm 12W 1575lm 840
 - ⁽²⁾ PHILIPS G13 1200mm 15,5W 2500lm 840
- More information about the LED Tube or available electrical schemes on page 180.

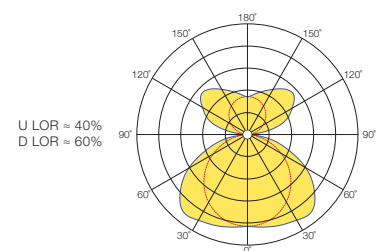
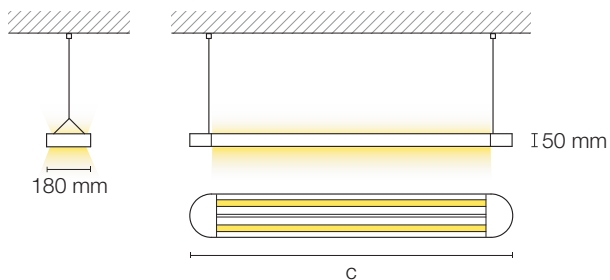
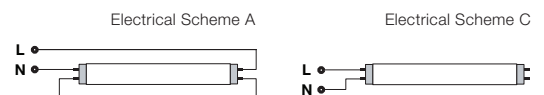

KINA SURFACE



PT

- Luminária para aplicações de iluminação geral em interiores.
- Aplicação saliente no teto.
- Disponível em três acabamentos standard (branco, preto ou cinza) e dois comprimentos.
- Corpo em chapa de aço com revestimento a epoxy-poliéster.
- Para funcionamento com tubos LED T8 (não incluídos).

EN

- Luminaire suitable for general interior lighting.
- For direct ceiling mounting.
- Available in three standard finishes (white, black or grey) and two lengths.
- Body made of sheet steel with epoxy-polyester powder coating.
- For use with T8 LED tubes (not included).

QUICK INFO

GENERAL

Surface
IP20
960°C
Class I
Ta= -20°C +35°C

LIGHT SOURCE

LED Tubes (T8 G13)

ELECTRICAL SYSTEM

220-240V/50-60Hz
ON/OFF

FINISHING

RAL 9016 White
RAL 9006 Grey
RAL 9005 Black

KINA SURFACE

MATT WHITE FINISHING

c (mm)	Tubes	Power (W)	Output (lm)	Scheme A	Scheme C
680	2	2x10 MAX	1587 ⁽¹⁾	33.44.000.01.26	33.44.000.01.14
1290	2	2x22 MAX	3778 ⁽²⁾	33.44.000.01.29	33.44.000.01.17

MATT GREY FINISHING

c (mm)	Tubes	Power (W)	Output (lm)	Scheme A	Scheme C
680	2	2x10 MAX	1563 ⁽¹⁾	33.44.000.01.27	33.44.000.01.15
1290	2	2x22 MAX	3722 ⁽²⁾	33.44.000.01.30	33.44.000.01.18

MATT BLACK FINISHING

c (mm)	Tubes	Power (W)	Output (lm)	Scheme A	Scheme C
680	2	2x10 MAX	1550 ⁽¹⁾	33.44.000.01.28	33.44.000.01.16
1290	2	2x22 MAX	3690 ⁽²⁾	33.44.000.01.31	33.44.000.01.19

LED TUBE (T8 G13) NOT INCLUDED

- ⁽¹⁾ PHILIPS G13 600mm 8W 1050lm 840
 - ⁽²⁾ PHILIPS G13 1200mm 15,5W 2500lm 840
- More information about the LED Tube or available electrical schemes on page 180.

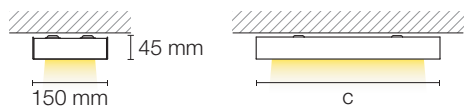
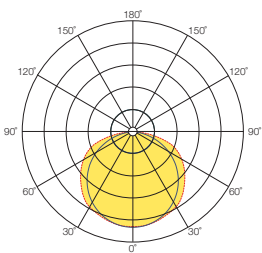
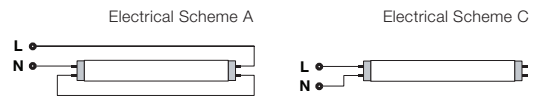

KUBA

SURFACE



PT

- Luminária para aplicações de iluminação geral em interiores.
- Caracterizada por formas curvas extremamente simples, com aspeto leve e equilibrado.
- Aplicação saliente no teto.
- Disponível em três acabamentos standard (branco, preto ou cinza) e dois comprimentos.
- Corpo em chapa de aço com revestimento a epoxy-poliéster.
- Para funcionamento com tubos LED T8 (não incluídos).

EN

- Luminaire suitable for general interior lighting.
- Characterized by extremely simple curved shapes for a light and balanced look.
- For direct ceiling mounting.
- Available in three standard finishes (white, black or grey) and two lengths.
- Body made of sheet steel with epoxy-polyester powder coating.
- For use with T8 LED tubes (not included).

QUICK INFO

GENERAL

Surface
IP20
960°C
Class I
Ta= -20°C +35°C

LIGHT SOURCE

LED Tubes (T8 G13)

ELECTRICAL SYSTEM

220-240V/50-60Hz
ON/OFF

FINISHING

RAL 9016 White
RAL 9006 Grey
RAL 9005 Black

KUBA SURFACE

MATT WHITE FINISHING

c (mm)	Tubes	Power (W)	Output (lm)	Scheme A	Scheme C
680	2	2x10 MAX	1547 ⁽¹⁾	33.44.000.01.32	33.44.000.01.20
1290	2	2x22 MAX	3682 ⁽²⁾	33.44.000.01.35	33.44.000.01.23

MATT GREY FINISHING

c (mm)	Tubes	Power (W)	Output (lm)	Scheme A	Scheme C
680	2	2x10 MAX	1414 ⁽¹⁾	33.44.000.01.33	33.44.000.01.21
1290	2	2x22 MAX	3366 ⁽²⁾	33.44.000.01.36	33.44.000.01.24

MATT BLACK FINISHING

c (mm)	Tubes	Power (W)	Output (lm)	Scheme A	Scheme C
680	2	2x10 MAX	1324 ⁽¹⁾	33.44.000.01.34	33.44.000.01.22
1290	2	2x22 MAX	3153 ⁽²⁾	33.44.000.01.37	33.44.000.01.25

LED TUBE (T8 G13) NOT INCLUDED

- ⁽¹⁾ PHILIPS G13 600mm 8W 1050lm 840
 - ⁽²⁾ PHILIPS G13 1200mm 15,5W 2500lm 840
- More information about the LED Tube or available electrical schemes on page 180.

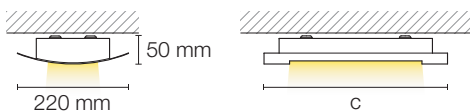
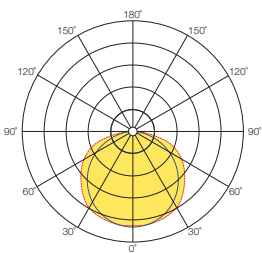
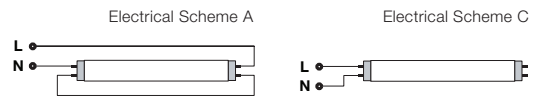

VITA

SURFACE



PT

- Luminária com difusor em vidro para aplicações de iluminação geral em interiores.
- Aplicação saliente no teto.
- Difusor em vidro totalmente fosco.
- Corpo em chapa de aço com revestimento a epoxy-poliéster.
- Equipada com sistema de fecho que permite facilidade e rapidez de instalação.
- Disponível em dois comprimentos para funcionamento com tubos LED T8 (não incluídos).

EN

- Luminaire with glass diffuser suitable for general interior lighting.
- For direct ceiling mounting.
- Fully frosted glass diffuser.
- Body made of sheet steel with epoxy-polyester powder coating.
- Diffuser closing system enables an easy and quick installation.
- Available in two lengths for use with T8 LED tubes (not included).

QUICK INFO

GENERAL

Surface
 IP20
 IK04
 960°C
 Class I
 Ta= -20°C +35°C

OPTIC

Frosted Glass

LIGHT SOURCE

LED Tubes (T8 G13)

ELECTRICAL SYSTEM

220-240V/50-60Hz
 ON/OFF

FINISHING

RAL 9016 White

VITA SURFACE

FROSTED GLASS DIFFUSER

c (mm)	Tubes	Power (W)	Output (lm)	Scheme A	Scheme C
672	2	2x10 MAX	1391 ⁽¹⁾	33.44.000.01.00	33.44.000.01.10
986	2	2x14 MAX	2087 ⁽²⁾	33.44.000.01.01	33.44.000.01.11

LED TUBE (T8 G13) NOT INCLUDED

- ⁽¹⁾ PHILIPS G13 600mm 8W 1050lm 840
 - ⁽²⁾ PHILIPS G13 900mm 12W 1575lm 840
- More information about the LED Tube or available electrical schemes on page 180.

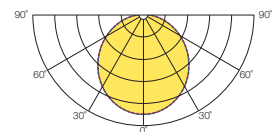
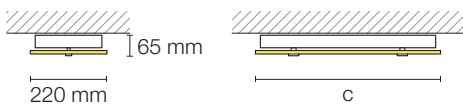
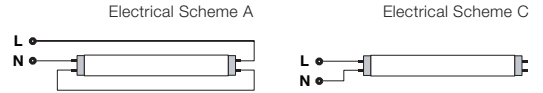

ROYAL-R SURFACE



PT

- Luminária com difusor em vidro para ambientes domésticos.
- Aplicação saliente no teto.
- Difusor curvo em vidro totalmente fosco.
- Corpo em chapa de aço com revestimento a epoxy-poliéster.
- Equipada com sistema de fecho que permite facilidade e rapidez de instalação.
- Disponível em três comprimentos para funcionamento com tubos LED T8 (não incluídos).

EN

- Luminaire with glass diffuser for home environments.
- For direct ceiling mounting.
- Fully frosted glass curved diffuser.
- Body made of steel sheet with epoxy-polyester powder coating.
- Diffuser closing system enables an easy and quick installation.
- Available in three lengths for use with T8 LED tubes (not included).

QUICK INFO

GENERAL

Surface
IP20
IK04
960°C
Class I
Ta= -20°C +35°C

OPTIC

Frosted Glass

LIGHT SOURCE

LED Tubes (T8 G13)

ELECTRICAL SYSTEM

220-240V/50-60Hz
ON/OFF

FINISHING

RAL 9016 White

**ROYAL-R SURFACE
FROSTED GLASS DIFFUSER**

c (mm)	Tubes	Power (W)	Output (lm)	Scheme A	Scheme C
700	2	2x10 MAX	1607 ⁽¹⁾	33.44.000.01.02	33.44.000.01.07
1040	2	2x14 MAX	2410 ⁽²⁾	33.44.000.01.03	33.44.000.01.08
1310	2	2x22 MAX	3825 ⁽³⁾	33.44.000.01.04	33.44.000.01.09

LED TUBE (T8 G13) NOT INCLUDED

- ⁽¹⁾ PHILIPS G13 600mm 8W 1050lm 840
- ⁽²⁾ PHILIPS G13 900mm 12W 1575lm 840
- ⁽³⁾ PHILIPS G13 1200mm 15,5W 2500lm 840

More information about the LED Tube or available electrical schemes on page 180.

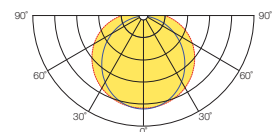
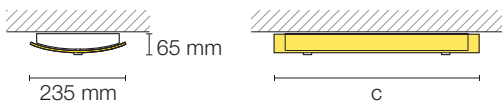
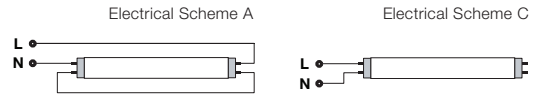

ROYAL-C SURFACE



PT

- Luminária com difusor em vidro para ambientes domésticos.
- Aplicação saliente no teto.
- Difusor curvo em vidro fosco com duas janelas que permitem uma passagem de luz mais intensa e direta.
- Corpo em chapa de aço com revestimento a epoxy-poliéster.
- Equipada com sistema de fecho que permite facilidade e rapidez de instalação.
- Disponível em dois comprimentos para funcionamento com tubos LED T8 (não incluídos).

EN

- Luminaire with glass diffuser for home environments.
- For direct ceiling mounting.
- Frosted glass curved diffuser with two windows to allow a more intense and direct light to come through.
- Body made of steel sheet with epoxy-polyester powder coating.
- Diffuser closing system enables an easy and quick installation.
- Available in two lengths for use with T8 LED tubes (not included).

QUICK INFO

GENERAL

Surface
IP20
IK04
960°C
Class I
Ta= -20°C +35°C

OPTIC

Frosted Glass

LIGHT SOURCE

LED Tubes (T8 G13)

ELECTRICAL SYSTEM

220-240V/50-60Hz
ON/OFF

FINISHING

RAL 9016 White

**ROYAL-C SURFACE
FROSTED GLASS DIFFUSER**

c (mm)	Tubes	Power (W)	Output (lm)	Scheme A	Scheme C
740	2	2x10 MAX	1751 ⁽¹⁾	33.44.000.01.05	33.44.000.01.12
1040	2	2x14 MAX	2626 ⁽²⁾	33.44.000.01.06	33.44.000.01.13

LED TUBE (T8 G13) NOT INCLUDED

- ⁽¹⁾ PHILIPS G13 600mm 8W 1050lm 840
 - ⁽²⁾ PHILIPS G13 900mm 12W 1575lm 840
- More information about the LED Tube or available electrical schemes on page 180.

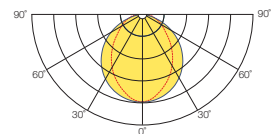
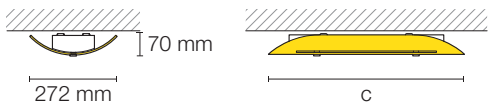
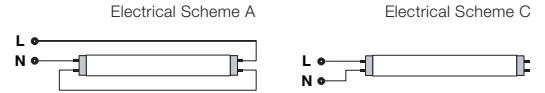

ONDATEC

SURFACE



PT

- Luminária decorativa para aplicações de iluminação geral em interiores.
- Aplicação saliente no teto.
- Difusor acrílico prismático de formato ondulado rematado por uma moldura em madeira.
- Moldura em madeira disponível com acabamento Mel ou Branco.
- Sistema de patilhas de fecho rápido do difusor para facilidade de instalação.
- Disponível em dois comprimentos para funcionamento com tubos LED T8 (não incluídos).

EN

- Decorative luminaire suitable for general interior lighting.
- For direct ceiling mounting.
- Wavy prismatic acrylic diffuser enhanced by a wood frame.
- Wood frame available in Honey or White finishing.
- Quick-release diffuser latches for easy installation.
- Available in two lengths for use with T8 LED tubes (not included).

QUICK INFO

GENERAL

Surface
IP30
IK05
650°C
Class I
Ta= -20°C +35°C

OPTIC

Clear Prismatic PMMA

LIGHT SOURCE

LED Tubes (T8 G13)

ELECTRICAL SYSTEM

220-240V/50-60Hz
ON/OFF

FINISHING

White Wood
Honey Wood

ONDATEC SURFACE

CLEAR PRISMATIC DIFFUSER

WHITE WOOD FINISHING

c (mm)	Tubes	Power (W)	Output (lm)	Scheme A	Scheme C
680	2	2x10 MAX	1212 ⁽¹⁾	33.45.000.01.00	33.45.000.01.06
1292	2	2x22 MAX	2886 ⁽²⁾	33.45.000.01.02	33.45.000.01.08

HONEY WOOD FINISHING

c (mm)	Tubes	Power (W)	Output (lm)	Scheme A	Scheme C
680	2	2x10 MAX	1212 ⁽¹⁾	33.45.000.01.01	33.45.000.01.07
1292	2	2x22 MAX	2886 ⁽²⁾	33.45.000.01.03	33.45.000.01.09

LED TUBE (T8 G13) NOT INCLUDED

- ⁽¹⁾ PHILIPS G13 600mm 8W 1050lm 840
 - ⁽²⁾ PHILIPS G13 1200mm 15,5W 2500lm 840
- More information about the LED Tube or available electrical schemes on page 180.

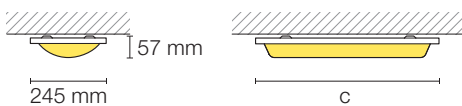
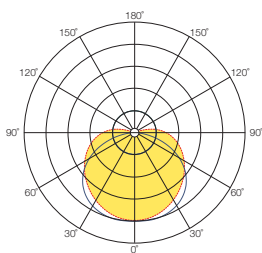
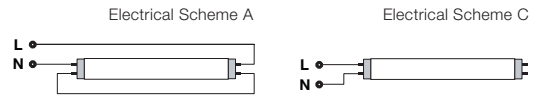

ROYAL WALL



PT

- Aplique LED de parede para iluminação ambiente decorativa.
- Caracterizado por formas curvas extremamente simples para um aspeto leve e equilibrado.
- Aplicação adequada em diferentes espaços de habitação e hotelaria.
- Luminária com fonte de alimentação incorporada.
- Difusor curvo em vidro totalmente fosco.
- Equipada com sistema de fecho que permite facilidade e rapidez de instalação.

EN

- Wall mounted LED luminaire for decorative ambient lighting.
- Characterized by extremely simple curved shapes for a light and balanced look.
- Suitable for residential and hotel applications.
- Luminaire with built-in power supply.
- Glass fully frosted curved diffuser.
- Diffuser closing system enables an easy and quick installation.

QUICK INFO

GENERAL

Wall
 IP20
 IK04
 960°C
 Class I
 Ta= -20°C +35°C

OPTIC

Frosted Glass

LIGHT SOURCE

LED Modules
 LED Lamp (E27)

SPECIFICATIONS

Efficacy up to 182 lm/W
 3000 K, 4000 K
 CRI >80
 Lifetime 72 000 H
 L80/B10 @Tc=65°C

ELECTRICAL SYSTEM

220-240V/50-60Hz
 ON/OFF

FINISHING

RAL 9016 White

**ROYAL WALL
 FROSTED GLASS DIFFUSER**

LED MODULES

Color Temp.	b×c (mm)	Output (lm)	System (W)	ON/OFF
2700 K	270×328	861	11	33.44.000.08.04
3000 K	270×328	1028	11	33.44.000.08.00
4000 K	270×328	1074	11	33.44.000.08.01

LED LAMP

Lamp	Power (W)	Output (lm)	ON/OFF
1×E27	1×100 MAX	195 ⁽¹⁾	33.44.000.08.02
2×E27	2×100 MAX	390 ⁽¹⁾	33.44.000.08.03

LED LAMP (E27) NOT INCLUDED

– ⁽¹⁾ PHILIPS E27 6W 470lm 840

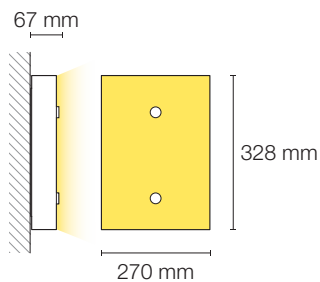
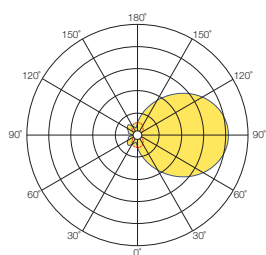



OFFICE

ADAS OPAL
SURFACE



ADAS E60
SURFACE

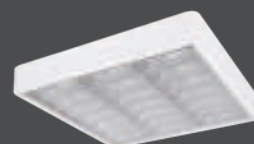

OFFICE-R OPAL
RECESSED



OFFICE-R E60
RECESSED

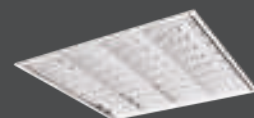

OFFICE PANEL
RECESSED

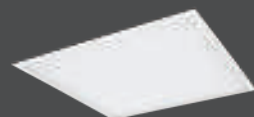

ADAS OPAL SURFACE



PT

- Luminária para ambientes domésticos ou profissionais.
- Aplicação saliente no teto.
- Difusor em PMMA Opal para iluminação homogénea, difusa e eficiente.
- Corpo em chapa de aço com revestimento a epoxy-poliéster.
- Em versões PCB LED e para tubos LED T8 (não incluídos).

EN

- Luminaire for home and office lighting.
- For direct ceiling mounting.
- Opal PMMA diffuser for efficient homogeneous lighting.
- Body made of sheet steel with epoxy-polyester powder coating.
- Available in PCB LED versions and for use with T8 LED tubes (not included).

QUICK INFO**GENERAL**

Surface
IP30
650°C
Class I
Ta= -20°C +35°C

OPTIC

Opal PMMA

LIGHT SOURCE

LED Modules
LED Tubes (T8 G13)

SPECIFICATIONS

Efficacy up to 176 lm/W
3000 K, 4000 K
CRI >80
Lifetime 72 000 H
L80/B10 @Tc=55°C

ELECTRICAL SYSTEM

220-240V/50-60Hz
ON/OFF, DALI

FINISHING

RAL 9016 White

ADAS SURFACE**OPAL DIFFUSER****LED MODULES**

Color Temp.	b×c (mm)	Output (lm)	System (W)	ON/OFF	DALI
3000 K	292×655	2105	18	33.59.000.08.07	33.59.000.08.15
	292×1267	4211	36	33.59.000.08.09	33.59.000.08.17
	292×1567	5264	44	33.59.000.08.10	33.59.000.08.18
	598×598	4252	36	33.59.000.08.08	33.59.000.08.16
4000 K	292×655	2208	18	33.59.000.08.11	33.59.000.08.19
	292×1267	4415	36	33.59.000.08.13	33.59.000.08.21
	292×1567	5519	44	33.59.000.08.14	33.59.000.08.22
	598×598	4458	36	33.59.000.08.12	33.59.000.08.20

LED TUBES

c (mm)	Tubes	Power (W)	Output (lm)	Scheme A	Scheme C
292×655	2	2×10 MAX	1314 ⁽¹⁾	33.59.000.01.00	33.59.000.01.12
292×1267	2	2×22 MAX	3128 ⁽²⁾	33.59.000.01.01	33.59.000.01.13
292×1567	2	2×24 MAX	4629 ⁽³⁾	33.59.000.01.03	33.59.000.01.15
598×655	4	4×10 MAX	2870 ⁽¹⁾	33.59.000.01.02	33.59.000.01.14

LED TUBE (T8 G13) NOT INCLUDED

- ⁽¹⁾ PHILIPS G13 600mm 8W 1050lm 840
- ⁽²⁾ PHILIPS G13 1200mm 15,5W 2500lm 840
- ⁽³⁾ PHILIPS G13 1500mm 23W 3700lm 840

More information about the LED Tube or available electrical schemes on page 180.

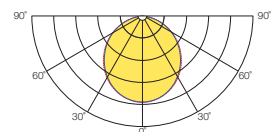
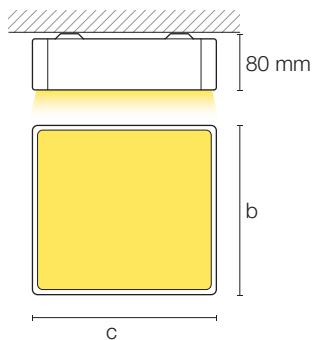
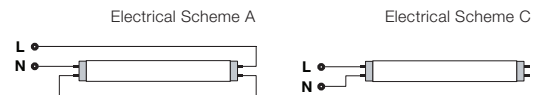

ADAS E60 SURFACE



PT

- Luminária para ambientes domésticos ou profissionais.
- Aplicação saliente no teto.
- Refletor em alumínio brilhante (E60).
- Corpo em chapa de aço com revestimento a epoxy-poliéster.
- Disponível em versões para dois ou quatro tubos LED T8 (não incluídos).

EN

- Luminaire for home and office lighting.
- For direct ceiling mounting.
- Specular aluminium louvre (E60).
- Body made of sheet steel with epoxy-polyester powder coating.
- Available in versions for two or four T8 LED tubes (not included).

QUICK INFO

GENERAL

Surface
 IP20
 850°C
 Class I
 Ta= -20°C +35°C

OPTIC

E60 Specular Aluminium Reflector

LIGHT SOURCE

LED Tubes (T8 G13)

ELECTRICAL SYSTEM

220-240V/50-60Hz
 ON/OFF, DALI

FINISHING

RAL 9016 White

ADAS SURFACE

E60 REFLECTOR

LED TUBES

c (mm)	Tubes	Power (W)	Output (lm)	Scheme A	Scheme C
292x655	2	2x10 MAX	1284 ⁽¹⁾	33.55.000.01.09	33.55.000.01.14
292x1267	2	2x22 MAX	3056 ⁽²⁾	33.55.000.01.10	33.55.000.01.15
292x1567	2	2x24 MAX	4523 ⁽³⁾	33.55.000.01.12	33.55.000.01.17
598x655	4	4x10 MAX	2610 ⁽¹⁾	33.55.000.01.11	33.55.000.01.16

LED TUBE (T8 G13) NOT INCLUDED

- ⁽¹⁾ PHILIPS G13 600mm 8W 1050lm 840
- ⁽²⁾ PHILIPS G13 1200mm 15,5W 2500lm 840
- ⁽³⁾ PHILIPS G13 1500mm 23W 3700lm 840

More information about the LED Tube or available electrical schemes on page 180.

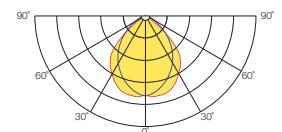
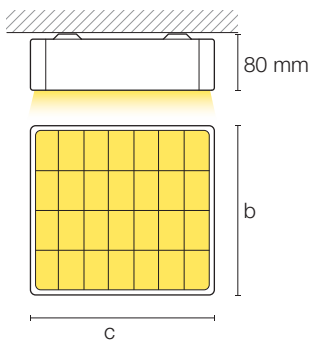
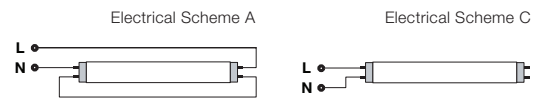

OFFICE-R OPAL RECESSED



PT

- Família de luminárias de encastrar que se adaptam à maioria dos tetos existentes no mercado.
- Aplicação universal em aberturas recortadas no teto ou em tetos modulares.
- Com conjunto de niveladores para instalação rápida e sem ferramentas.
- Índice de proteção IP40 na face visível.
- Difusor em PMMA Opal para iluminação homogénea, difusa e eficiente.
- Corpo em chapa de aço com revestimento a epoxy-poliéster.
- Em versões PCB LED e versões para tubos LED T8 (não incluídos).

EN

- Family of recessed luminaires to fit the majority of ceilings in the market.
- Can be universally used in cut-out recess openings and in modular ceilings.
- Tool-free ceiling installation via rapid-mounting brackets.
- IP40 protection rating on the visible body.
- Opal PMMA diffuser for efficient homogeneous lighting.
- Body made of sheet steel with epoxy-polyester powder coating.
- Available in PCB LED versions and for use with T8 LED tubes (not included).

QUICK INFO**GENERAL**

Recessed
 IP40 (Optic), IP20 (Geral)
 IK03 - Opal Diffuser
 650°C
 Class I
 Ta= -20°C +35°C

OPTIC

Opal PMMA

LIGHT SOURCE

LED Modules
 LED Tubes (T8 G13)

SPECIFICATIONS

Efficacy up to 176 lm/W
 3000 K, 4000 K
 CRI >80
 Lifetime 72 000 H
 L80/B10 @Tc=55°C

ELECTRICAL SYSTEM

220-240V/50-60Hz
 ON/OFF, DALI

FINISHING

RAL 9016 White

OFFICE-R RECESSED**OPAL DIFFUSER****LED MODULES**

Color Temp.	b×c (mm)	Output (lm)	System (W)	ON/OFF	DALI
3000 K	297×598	2105	18	33.59.000.08.23	33.59.000.08.31
	297×1198	4211	36	33.59.000.08.24	33.59.000.08.32
	297×1498	5264	44	33.59.000.08.25	33.59.000.08.33
4000 K	598×598	4252	36	33.59.000.08.26	33.59.000.08.34
	297×598	2208	18	33.59.000.08.27	33.59.000.08.35
	297×1198	4415	36	33.59.000.08.28	33.59.000.08.36
	297×1498	5519	44	33.59.000.08.29	33.59.000.08.37
	598×598	4458	36	33.59.000.08.30	33.59.000.08.38

OPTIONS**EMERGENCY (EM) - SELF-TEST INTEGRATED**

ON/OFF	COD
EM 1H 3W	35.00.003.01.23
EM 3H 3W	35.00.003.01.24
DALI	COD
EM 1H 5,4W DALI	35.00.004.01.54
EM 3H 5,4W DALI	35.00.004.01.55

OPTIONS**EMERGENCY**

1 Hour, 3 Hours
 DALI 1 Hour, 3 Hours

LED TUBES

c (mm)	Tubes	Power (W)	Output (lm)	Scheme A	Scheme C
297×598	2	2×10 MAX	2100 ⁽¹⁾	33.59.000.01.08	33.59.000.01.20
297×1198	2	2×22 MAX	5000 ⁽²⁾	33.59.000.01.09	33.59.000.01.21
297×1498	2	2×24 MAX	7400 ⁽³⁾	33.59.000.01.10	33.59.000.01.22
598×598	4	4×10 MAX	2870 ⁽¹⁾	33.59.000.01.11	33.59.000.01.23

CUT OUT

+2
 -2
b×c (mm)
 285×585
 285×1185
 285×1485
 585×585

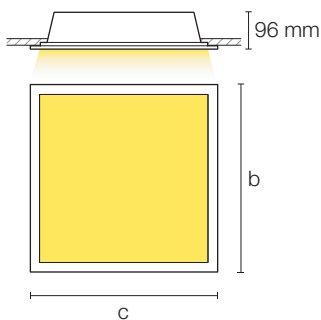
**LED TUBE (T8 G13) NOT INCLUDED**

- ⁽¹⁾ PHILIPS G13 600mm 8W 1050lm 840
- ⁽²⁾ PHILIPS G13 1200mm 15,5W 2500lm 840
- ⁽³⁾ PHILIPS G13 1500mm 23W 3700lm 840

More information about the LED Tube or available electrical schemes on page 180.

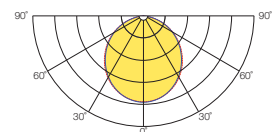
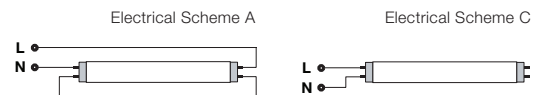

OFFICE-R E60 RECESSED



PT

- Família de luminárias de encastrar que se adaptam à maioria dos tetos existentes no mercado.
- Aplicação universal em aberturas recortadas no teto ou em tetos modulares.
- Com conjunto de niveladores para instalação rápida e sem ferramentas.
- Refletor em alumínio brilhante (E60).
- Corpo em chapa de aço com revestimento a epoxy-poliéster.
- Disponível em versões para dois ou quatro tubos LED T8 (não incluídos).

EN

- Family of recessed luminaires to fit the majority of ceilings in the market.
- Can be universally used in cut-out recess openings and in modular ceilings.
- Tool-free ceiling installation via rapid-mounting brackets.
- Specular aluminium louvre (E60).
- Body made of sheet steel with epoxy-polyester powder coating.
- Available in versions for two or four T8 LED tubes (not included).

QUICK INFO

GENERAL

Recessed
 IP20
 850°C
 Class I
 Ta= -20°C +35°C

OPTIC

E60 Specular Aluminium Reflector

LIGHT SOURCE

LED Tubes (T8 G13)

ELECTRICAL SYSTEM

220-240V/50-60Hz
 ON/OFF

FINISHING

RAL 9016 White

**OFFICE-R RECESSED
 E60 REFLECTOR**

LED TUBES

b×c (mm)	Tubes	Power (W)	Output (lm)	Scheme A	Scheme C
297×598	2	2×10 MAX	1284 ⁽¹⁾	33.59.000.01.04	33.59.000.01.16
297×1198	2	2×22 MAX	3056 ⁽²⁾	33.59.000.01.05	33.59.000.01.17
297×1498	2	2×24 MAX	4523 ⁽³⁾	33.59.000.01.06	33.59.000.01.18
598×598	4	4×10 MAX	2610 ⁽¹⁾	33.59.000.01.07	33.59.000.01.19

LED TUBE (T8 G13) NOT INCLUDED

- ⁽¹⁾ PHILIPS G13 600mm 8W 1050lm 840
- ⁽²⁾ PHILIPS G13 1200mm 15,5W 2500lm 840
- ⁽³⁾ PHILIPS G13 1500mm 23W 3700lm 840

More information about the LED Tube or available electrical schemes on page 180.

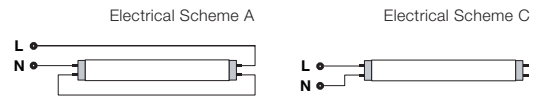

CUT OUT

- +2
 -2
- b × c (mm)**
 285×585
 285×1185
 285×1485
 585×585

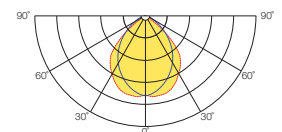
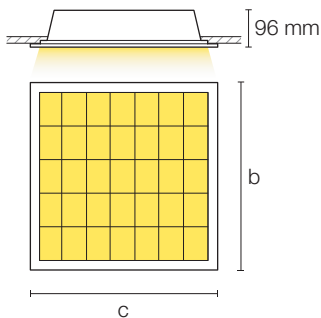

OFFICE PANEL RECESSED

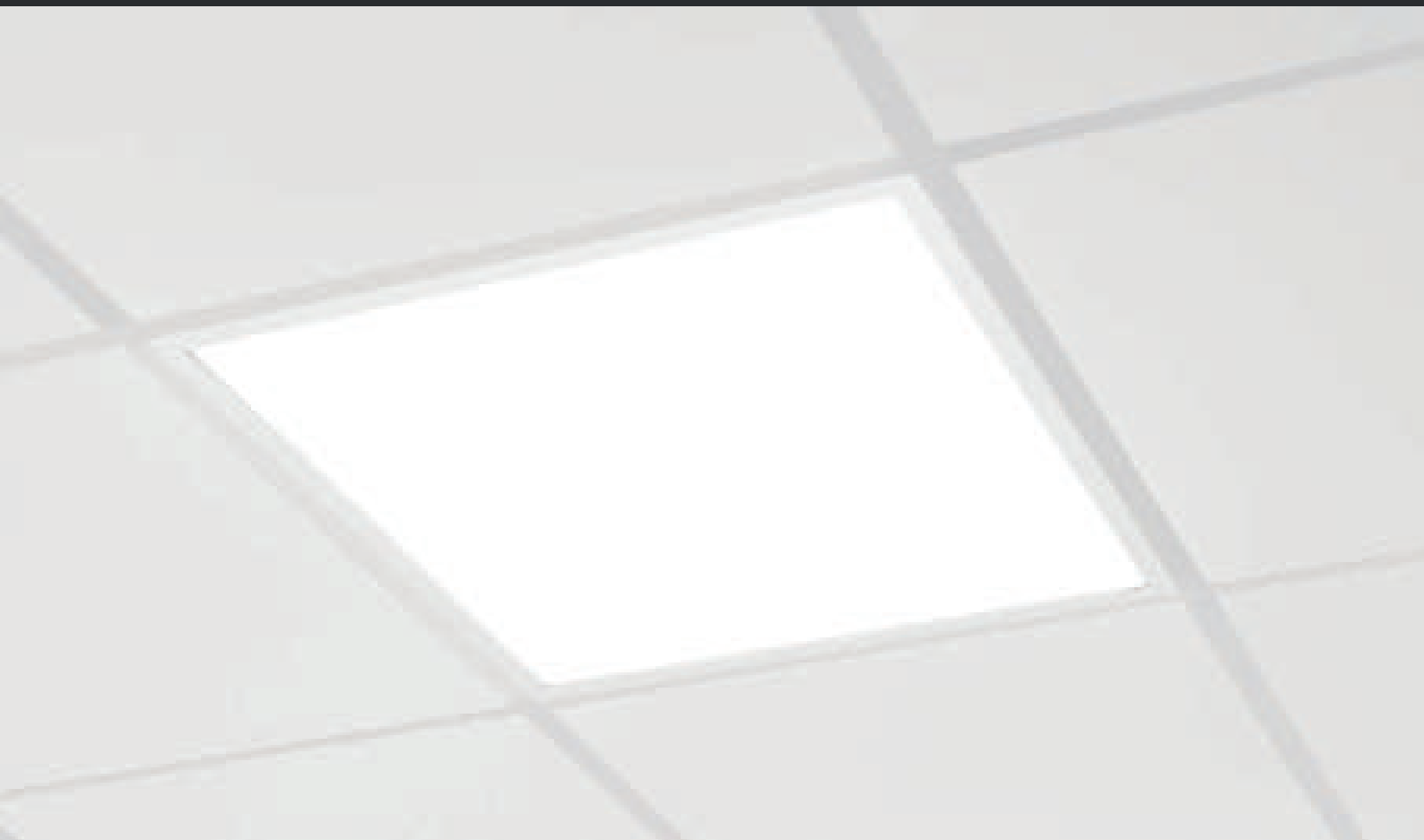

PT

- Painel LED de aplicação encastrada para ambientes domésticos ou profissionais.
- Para tetos falsos modulares com reticula suspensa de 600 e 625 mm.
- Possibilidade de aplicação saliente ou suspensa com acessórios (não incluídos).
- Driver externo de tensão constante e classe de proteção II (incluído).
- Difusor PS Micropismático para controlo do encandeamento (UGR <19).
- Sistema LED com extraordinária eficiência de até 101 lm/W.
- Temperaturas de cor 3000 ou 4000 K.

EN

- Modular recessed-mounted LED Panel for home and office lighting.
- For suspended false ceiling grid measure of 600 and 625 mm.
- Surface or suspended mount with accessories (not included).
- External class II constant voltage Driver (included).
- Micro prismatic PS diffuser for glare control (UGR <19).
- LED solution with outstanding system efficacy up to 101 lm/W.
- Colour temperatures 3000 or 4000 K.

QUICK INFO

GENERAL

Recessed (Ceiling Grid)
Surface, Suspended (Accessories)
IP20
IK05
650°C
Class II
Ta= -20°C +40°C

OPTIC

Micro Prismatic PS
UGR <19

LIGHT SOURCE

LED Modules

SPECIFICATIONS

Efficacy up to 101 lm/W
3000 K, 4000 K
CRI >80
Lifetime 50 000 H
L70/B10 @Tc=45°C

ELECTRICAL SYSTEM

220-240V/50-60Hz
ON/OFF

FINISHING

RAL 9003 White

OPTIONS

EMERGENCY

1 Hour, 3 Hours
DALI 1 Hour, 3 Hours

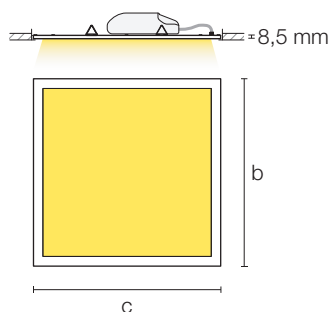
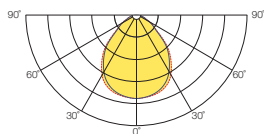
OFFICE PANEL RECESSED
MICRO PRISMATIC DIFFUSER

LED MODULES

Color Temp.	b×c (mm)	Output (lm)	System (W)	ON/OFF	DALI
3000 K	595×595	3620	35	33.41.22.000131	33.41.22.000138
	620×620	3620	35	33.41.22.000133	33.41.22.000140
	295×1195	3620	35	33.41.22.000136	33.41.22.000142
4000 K	595×595	3900	35	33.41.22.000132	33.41.22.000139
	620×620	3900	35	33.41.22.000134	33.41.22.000141
	295×1195	3900	35	33.41.22.000137	33.41.22.000143

ACCESSORIES



SURFACE CEILING CUP (1pc)

TYPE	1m	3m	5m
Matt White Ø62x36 mm	35.49.001.08.30	35.49.002.08.59	35.49.002.08.67



RECESSED CEILING CUP (1pc)

TYPE	1m	3m	5m
Matt White Ø80 mm	35.49.001.08.31	35.49.002.08.63	35.49.002.08.71



SUSPENDED MOUNTING KIT (1pc)

TYPE	DIMENSIONS	1,2m
Stainless Steel	600 - 625 mm	35.41.22.000303
	300×1200 mm	35.41.22.000312

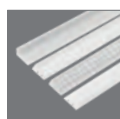

SURFACE MOUNTING KIT (1pc)

TYPE	DIMENSIONS	COD
Matt White	601×601×44 mm	35.41.22.000301
	626×626×44 mm	35.41.22.000302
	300×1200×44 mm	35.41.22.000311

OPTIONS



EXTERNAL EMERGENCY BOX (EM)

ON/OFF	REST MODE	DIMENSION	COD
EM BOX 1H 3W	6-12 V	45×120×360 mm	35.00.005.01.02
EM BOX 3H 3W	6-12 V	45×120×360 mm	35.00.005.01.03
DALI	REST MODE	DIMENSION	COD
EM BOX 1H 5,4W DALI	6-12 V	45×120×360 mm	35.00.005.01.04
EM BOX 3H 5,4W DALI	6-12 V	45×120×360 mm	35.00.005.01.05



ACRYLIC

ATA
SURFACE

ACDE
SURFACE

CANTHOR
SURFACE

ACO
SURFACE



ATA SURFACE



PT

- Luminária com difusão de luz em todas as faces do difusor.
- Aplicação saliente no teto.
- Índice de proteção IP40.
- Versões PCB LED equipadas com difusor opal para luz difusa.
- Versões para tubos LED T8 (não incluídos) com difusor prismático.
- Sistema de patilhas de fecho rápido do difusor para facilidade de instalação.

EN

- Luminaire with light diffusion on all faces of the diffuser.
- For direct ceiling mounting.
- IP40 protection rating.
- PCB LED versions equipped with opal diffuser for diffuse lighting.
- Versions for use with T8 LED tubes (not included) with prismatic diffuser.
- Quick-release diffuser latches for easy installation.

QUICK INFO

GENERAL

Surface
IP30
IK05
650°C
Class I
Ta= -20°C +35°C

OPTIC

Opal PMMA - LED Modules
Clear Prismatic PMMA - LED Tubes

LIGHT SOURCE

LED Modules
LED Tubes (T8 G13)

SPECIFICATIONS

Efficacy up to 176 lm/W
3000 K, 4000 K
CRI >80
Lifetime 72 000 H
L80/B10 @TC=55°C

ELECTRICAL SYSTEM

220-240V/50-60Hz
ON/OFF

FINISHING

RAL 9016 White

ATA SURFACE

OPAL DIFFUSER

LED MODULES

Color Temp.	a×b×c (mm)	Output (lm)	System (W)	ON/OFF	DALI
3000 K	70×192×654	3273	25	33.50.000.08.02	33.50.000.08.05
	70×192×1260	6546	51	33.50.000.08.03	33.50.000.08.06
	83×675×675	5789	51	33.50.000.08.04	33.50.000.08.07
4000 K	70×192×654	3445	25	33.50.000.08.08	33.50.000.08.11
	70×192×1260	6890	51	33.50.000.08.09	33.50.000.08.12
	83×675×675	6093	51	33.50.000.08.10	33.50.000.08.13

CLEAR PRISMATIC DIFFUSER

LED TUBES

a×b×c (mm)	Tubes	Power (W)	Output (lm)	Scheme A	Scheme C
70×192×654	2	2×10 MAX	1725 ⁽¹⁾	33.50.000.01.00	33.50.000.01.07
70×192×1260	2	2×22 MAX	4108 ⁽²⁾	33.50.000.01.01	33.50.000.01.08
83×675×675	4	4×10 MAX	3864 ⁽¹⁾	33.50.000.01.02	33.50.000.01.09

LED TUBE (T8 G13) NOT INCLUDED

- ⁽¹⁾ PHILIPS G13 600mm 8W 1050lm 840
 - ⁽²⁾ PHILIPS G13 1200mm 15,5W 2500lm 840
- More information about the LED Tube or available electrical schemes on page 180.

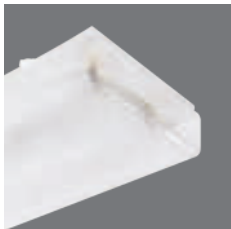
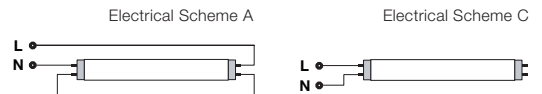

- Clear Prismatic PMMA Diffuser for LED Tubes.

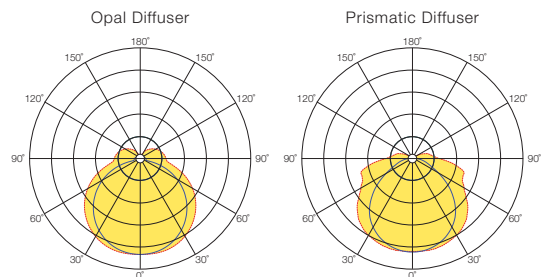
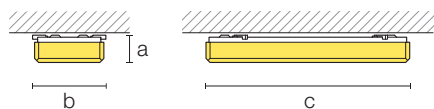
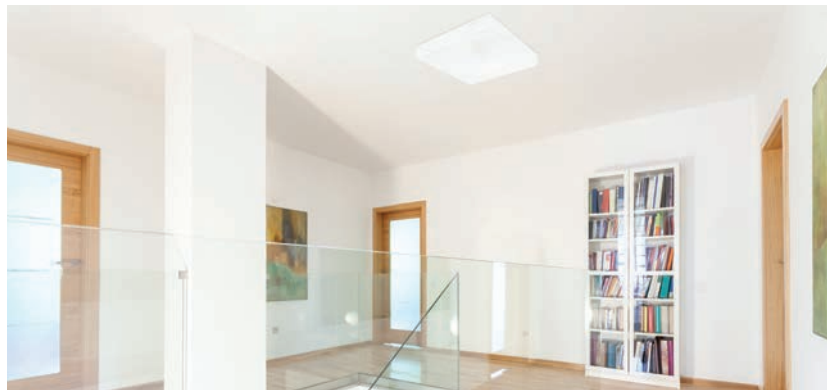

ACDE SURFACE

ACDE 2x...W

ACDE 1x...W



PT

- Luminária de grande funcionalidade para aplicações de iluminação geral em interiores.
- Aplicação saliente no teto.
- Difusor acrílico listado para iluminação eficiente.
- Corpo em chapa de aço com revestimento a epoxy-poliéster.
- Equipada com sistema de fecho que permite facilidade e rapidez de instalação.
- Disponível em versões para um ou dois tubos LED T8 (não incluídos).

EN

- High-functionality luminaire suitable for general interior lighting.
- For direct ceiling mounting.
- Ribbed acrylic diffuser for efficient lighting.
- Body made of steel sheet with epoxy-polyester powder coating.
- Diffuser closing system enables an easy and quick installation.
- Available in versions for one or two T8 LED tubes (not included).

QUICK INFO

GENERAL

Surface
IP30
IK05
650°C
Class I
Ta= -20°C +35°C

OPTIC

Ribbed PMMA

LIGHT SOURCE

LED Tubes (T8 G13)

ELECTRICAL SYSTEM

220-240V/50-60Hz
ON/OFF

FINISHING

RAL 9016 White

ACDE SURFACE

RIBBED DIFFUSER

LED TUBES

b×c (mm)	Tubes	Power (W)	Output (lm)	Scheme A	Scheme C
70×630	1	1×10 MAX	800 ⁽¹⁾	33.10.000.01.00	33.10.000.01.06
70×1240	1	1×22 MAX	1200 ⁽²⁾	33.10.000.01.01	33.10.000.01.07
70×1540	1	1×24 MAX	1905 ⁽³⁾	33.10.000.01.02	33.10.000.01.08
177×645	2	2×10 MAX	1587 ⁽¹⁾	33.10.000.01.03	33.10.000.01.09
177×1255	2	2×22 MAX	2381 ⁽²⁾	33.10.000.01.04	33.10.000.01.10
177×1555	2	2×24 MAX	3779 ⁽³⁾	33.10.000.01.05	33.10.000.01.11

LED TUBE (T8 G13) NOT INCLUDED

- ⁽¹⁾ PHILIPS G13 600mm 8W 1050lm 840
- ⁽²⁾ PHILIPS G13 1200mm 15,5W 2500lm 840
- ⁽³⁾ PHILIPS G13 1500mm 23W 3700lm 840

More information about the LED Tube or available electrical schemes on page 180.

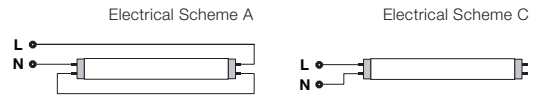

ACDE 1x...W

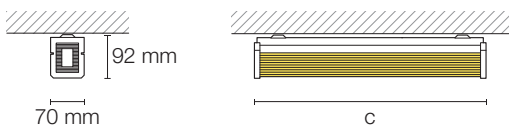

ACDE 2x...W

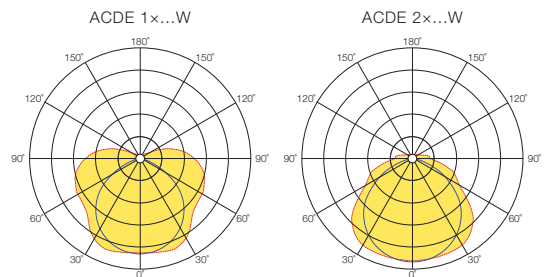
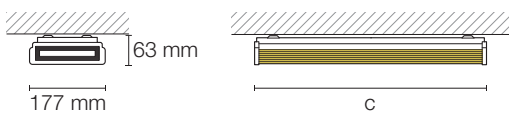

CANTHOR

SURFACE



PT

- Luminária discreta para aplicações de iluminação geral em interiores.
- Aplicação saliente no teto.
- Índice de proteção IP40.
- Versões PCB LED equipadas com difusor opal para luz difusa.
- Versões para tubos LED T8 (não incluídos) com difusor prismático.
- Sistema de patilhas de fecho rápido do difusor para facilidade de instalação.

EN

- Unobtrusive luminaire suitable for general interior lighting.
- For direct ceiling mounting.
- IP40 protection rating.
- PCB LED versions equipped with opal diffuser for diffuse lighting.
- Versions for use with T8 LED tubes (not included) with prismatic diffuser.
- Quick-release diffuser latches for easy installation.

QUICK INFO

GENERAL

Surface
IP30
IK05
650°C
Class I
Ta= -20°C +35°C

OPTIC

Opal PMMA - LED Modules
Clear Prismatic PMMA - LED Tubes

LIGHT SOURCE

LED Modules
LED Tubes (T8 G13)

SPECIFICATIONS

Efficacy up to 176 lm/W
3000 K, 4000 K
CRI >80
Lifetime 72 000 H
L80/B10 @Tc=55°C

ELECTRICAL SYSTEM

220-240V/50-60Hz
ON/OFF, DALI

FINISHING

RAL 9016 White

CANTHOR SURFACE

OPAL DIFFUSER

LED MODULES

Color Temp.	c (mm)	Output (lm)	System (W)	ON/OFF	DALI
3000 K	648	2750	25	33.50.000.08.14	33.50.000.08.18
	1248	5500	51	33.50.000.08.15	33.50.000.08.19
4000 K	648	2895	25	33.50.000.08.16	33.50.000.08.20
	1248	5789	51	33.50.000.08.17	33.50.000.08.21

CLEAR PRISMATIC DIFFUSER

LED TUBES

c (mm)	Tubes	Power (W)	Output (lm)	Scheme A	Scheme C
648	2	2x10 MAX	1526 ⁽¹⁾	33.50.000.01.03	33.50.000.01.12
1248	2	2x22 MAX	3633 ⁽²⁾	33.50.000.01.04	33.50.000.01.13

LED TUBE (T8 G13) NOT INCLUDED

- ⁽¹⁾ PHILIPS G13 600mm 8W 1050lm 840
- ⁽²⁾ PHILIPS G13 1200mm 15,5W 2500lm 840
More information about the LED Tube or available electrical schemes on page 180.

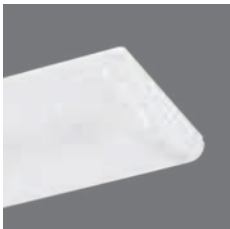
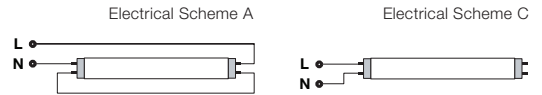

- Clear Prismatic PMMA Diffuser for LED Tubes.

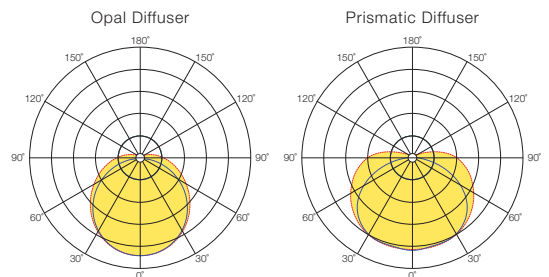
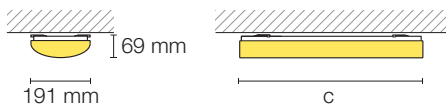

ACO

CORNER SURFACE



PT

- Luminária de canto para aplicação saliente em interiores.
- Possibilidade de aplicação horizontal ou vertical.
- Versões PCB LED equipadas com difusor opal para luz difusa.
- Versões para tubos LED T8 (não incluídos) com difusor prismático.
- Corpo em chapa de aço de formato triangular com ângulo de 45°.
- Sistema de patilhas de fecho rápido do difusor para facilidade de instalação.

EN

- Corner surface mounted luminaire for indoor applications.
- Possibility of horizontal or vertical installation.
- PCB LED versions equipped with opal diffuser for diffuse lighting.
- Versions for use with T8 LED tubes (not included) with prismatic diffuser.
- Triangular-shaped steel sheet body with 45° angle.
- Quick-release diffuser latches for easy installation.

QUICK INFO

GENERAL

Corner Surface
IP30
IK05
650°C
Class I
Ta= -20°C +35°C

OPTIC

Opal Polycarbonate - LED Modules
Clear Prismatic PMMA - LED Tubes

LIGHT SOURCE

LED Modules
LED Tubes (T8 G13)

SPECIFICATIONS

Efficacy up to 176 lm/W
3000 K, 4000 K
CRI >80
Lifetime 72 000 H
L80/B10 @Tc=55°C

ELECTRICAL SYSTEM

220-240V/50-60Hz
ON/OFF, DALI

FINISHING

RAL 9016 White

ACO CORNER SURFACE

OPAL DIFFUSER

LED MODULES

Color Temp.	c (mm)	Output (lm)	System (W)	ON/OFF	DALI
3000 K	648	2220	25	33.04.000.08.00	33.04.000.08.04
	1248	4441	51	33.04.000.08.01	33.04.000.08.05
4000 K	648	2337	25	33.04.000.08.02	33.04.000.08.06
	1248	4674	51	33.04.000.08.03	33.04.000.08.07

OPTIONS



EMERGENCY (EM) - SELF-TEST INTEGRATED

ON/OFF	COD
EM 1H 3W	35.00.003.01.23
EM 3H 3W	35.00.003.01.24
DALI	COD
EM 1H 5,4W DALI	35.00.004.01.54
EM 3H 5,4W DALI	35.00.004.01.55

OPTIONS

EMERGENCY

1 Hour, 3 Hours
DALI 1 Hour, 3 Hours

CLEAR PRISMATIC DIFFUSER

LED TUBES

c (mm)	Tubes	Power (W)	Output (lm)	Scheme A	Scheme C
648	2	2x10 MAX	1451 ⁽¹⁾	33.04.000.01.00	33.04.000.01.02
1248	2	2x22 MAX	2177 ⁽²⁾	33.04.000.01.01	33.04.000.01.03



- Clear Prismatic PMMA Diffuser for LED Tubes.

LED TUBE (T8 G13) NOT INCLUDED

- ⁽¹⁾ PHILIPS G13 600mm 8W 1050lm 840
 - ⁽²⁾ PHILIPS G13 1200mm 15,5W 2500lm 840
- More information about the LED Tube or available electrical schemes on page 180.

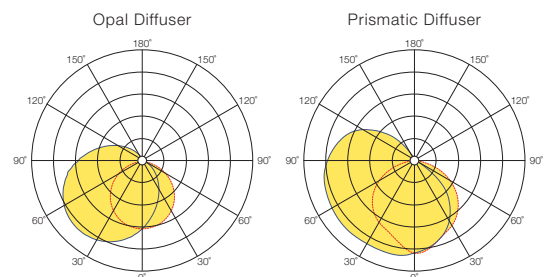
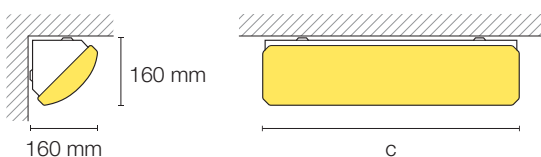
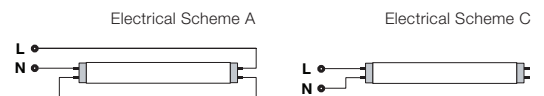



DOWNLIGHTS

SIRIUS 120,170,225
RECESSED



SIRIUS-D 137 IP44
RECESSED



SIRIUS-D 187 IP44
RECESSED



SIRIUS-R 184 RO
ADJUSTABLE RECESSED



SIRIUS-R SQ SINGLE
ADJUSTABLE RECESSED



SIRIUS-R SQ DUO
ADJUSTABLE RECESSED



SIRIUS-R R111
ADJUSTABLE RECESSED



SIRIUS RECESSED



PT

- Downlight de elevada eficiência para atualização da iluminação convencional para tecnologia LED.
- Fonte de luz recuada para controlo do encandeamento e elevado conforto visual.
- Refletor facetado com duas opções de ângulo de abertura: 60° ou 90°.
- Índice de proteção IP40 na face visível.
- Luminária com fonte de alimentação incorporada.
- Com molas de fixação rápida para instalação sem ferramentas.

EN

- High efficiency downlight for upgrading conventional lighting to LED technology.
- The rearward LED position avoids glare, providing a greater sense of visual comfort.
- Faceted reflector with choice of two beam angles: 60° or 90°.
- IP40 protection rating on the visible body.
- Luminaire with built-in power supply.
- Tool free spring clip installation, directly out of the box.

QUICK INFO

GENERAL

Recessed
IP40
IK04
850°C
Class II
Ta= -20°C +35°C

OPTIC

Opal Polycarbonate
+ Aluminium Reflector

LIGHT SOURCE

LED Modules

SPECIFICATIONS

Efficacy up to 109 lm/W
3000 K, 4000 K
CRI >80
Lifetime 50 000 H
L70/B10 @TC=65°C

ELECTRICAL SYSTEM

220-240V/50-60Hz
ON/OFF

FINISHING

RAL 9003 Matt White

OPTIONS

EMERGENCY

1 Hour, 3 Hours
DALI 1 Hour, 3 Hours

CUT OUT

- +2 10W - Ø108 mm
- 2 20W - Ø158 mm
- 30W - Ø210 mm

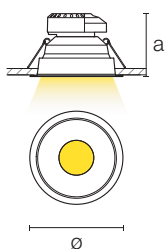

**SIRIUS RECESSED
MIRO SILVER® REFLECTOR**

Color Temp.	Beam (°)	Ø×a (mm)	Output (lm)	System (W)	COD
3000 K	60°	Ø120×85	1060	10	33.92.011.08.62
		Ø170×115	2130	20	33.92.011.08.66
		Ø225×135	3070	30	33.92.011.08.70
	90°	Ø120×85	1060	10	33.92.011.08.63
		Ø170×115	2130	20	33.92.011.08.67
		Ø225×135	3070	30	33.92.011.08.71
4000 K	60°	Ø120×85	1110	10	33.92.011.08.64
		Ø170×115	2210	20	33.92.011.08.68
		Ø225×135	3180	30	33.92.011.08.72
	90°	Ø120×85	1110	10	33.92.011.08.65
		Ø170×115	2210	20	33.92.011.08.69
		Ø225×135	3180	30	33.92.011.08.73

OPTIONS



EXTERNAL EMERGENCY BOX (EM)

ON/OFF	REST MODE	DIMENSION	COD
EM BOX 1H 3W	6-12 V	45×120×360 mm	35.00.005.01.02
EM BOX 3H 3W	6-12 V	45×120×360 mm	35.00.005.01.03
DALI		DIMENSION	COD
EM BOX 1H 5,4W DALI		45×120×360 mm	35.00.005.01.04
EM BOX 3H 5,4W DALI		45×120×360 mm	35.00.005.01.05

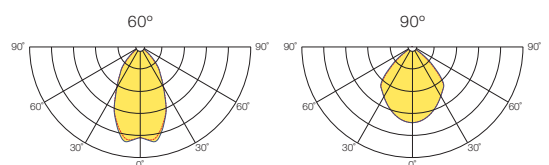

SIRIUS-D 137 IP44 RECESSED



PT

- Downlight de luz homogénea para aplicação encastrada.
- Índice de proteção IP44 na face visível.
- Com molas de fixação rápida para instalação sem ferramentas.
- Adequado para instalação em tetos falsos com espessura entre 1 e 25 mm.
- Luminária com fonte de alimentação incorporada.
- Difusor policarbonato opal para iluminação homogénea, difusa e eficiente.
- Aro de remate em alumínio com revestimento a epoxy-poliéster.

EN

- Homogeneous lighting recessed downlight.
- IP44 protection rating on the visible body.
- Tool free spring clip installation, directly out of the box.
- Suitable for 1-25 mm ceiling thicknesses.
- Luminaire with built-in power supply.
- Opal polycarbonate diffuser for efficient homogeneous lighting.
- Epoxy-polyester powder coated aluminium rim.

QUICK INFO**GENERAL**

Recessed
 IP44 (Optic), IP20 (Geral)
 IK06
 850°C
 Class II
 Ta= -20°C +35°C

OPTIC

Opal Polycarbonate

LIGHT SOURCE

LED Modules

SPECIFICATIONS

Efficacy up to 109 lm/W
 3000 K, 4000 K
 CRI >80
 Lifetime 50 000 H
 L70/B10 @Tc=65°C

ELECTRICAL SYSTEM

220-240V/50-60Hz
 ON/OFF

FINISHING

RAL 9003 Matt White

OPTIONS**EMERGENCY**

1 Hour, 3 Hours
 DALI 1 Hour, 3 Hours

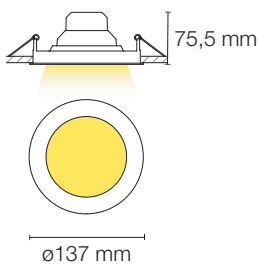
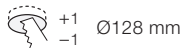
CUT OUT**SIRIUS-D 137 RECESSED****OPAL DIFFUSER****IP44**

Color Temp.	Ø (mm)	Output (lm)	System (W)	COD
3000 K	137	722	10	33.92.011.08.99
4000 K	137	752	10	33.92.012.08.00

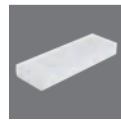
OPTIONS**EXTERNAL EMERGENCY BOX (EM)**

ON/OFF	REST MODE	DIMENSION	COD
EM BOX 1H 3W	6-12 V	45×120×360 mm	35.00.005.01.02
EM BOX 3H 3W	6-12 V	45×120×360 mm	35.00.005.01.03
DALI		DIMENSION	COD
EM BOX 1H 5,4W DALI		45×120×360 mm	35.00.005.01.04
EM BOX 3H 5,4W DALI		45×120×360 mm	35.00.005.01.05

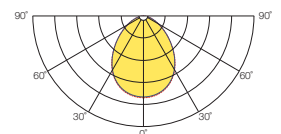

SIRIUS-D 187 IP44 RECESSED



PT

- Downlight de luz homogénea para aplicação encastrada.
- Índice de proteção IP44 na face visível.
- Com molas de fixação rápida para instalação sem ferramentas.
- Adequado para instalação em tetos falsos com espessura entre 1 e 25 mm.
- Luminária com fonte de alimentação incorporada.
- Difusor policarbonato opal para iluminação homogénea, difusa e eficiente.
- Aro de remate em alumínio com revestimento a epoxy-poliéster.

EN

- Homogeneous lighting recessed downlight.
- IP44 protection rating on the visible body.
- Tool free spring clip installation, directly out of the box.
- Suitable for 1-25 mm ceiling thicknesses.
- Luminaire with built-in power supply.
- Opal polycarbonate diffuser for efficient homogeneous lighting.
- Epoxy-polyester powder coated aluminium rim.

QUICK INFO

GENERAL

Recessed
 IP44 (Optic), IP20 (Geral)
 IK06
 850°C
 Class II
 Ta= -20°C +35°C

OPTIC

Opal Polycarbonate

LIGHT SOURCE

LED Modules

SPECIFICATIONS

Efficacy up to 109 lm/W
 3000 K, 4000 K
 CRI >80
 Lifetime 50 000 H
 L70/B10 @Tc=65°C

ELECTRICAL SYSTEM

220-240V/50-60Hz
 ON/OFF

FINISHING

RAL 9003 Matt White

SIRIUS-D 187 RECESSED

OPAL DIFFUSER

IP44

Color Temp.	Ø (mm)	Output (lm)	System (W)	COD
3000 K	187	1448	20	33.92.012.08.01
4000 K	187	1507	20	33.92.012.08.02

OPTIONS



EXTERNAL EMERGENCY BOX (EM)

ON/OFF	REST MODE	DIMENSION	COD
EM BOX 1H 3W	6-12 V	45x120x360 mm	35.00.005.01.02
EM BOX 3H 3W	6-12 V	45x120x360 mm	35.00.005.01.03

DALI	DIMENSION	COD
EM BOX 1H 5,4W DALI	45x120x360 mm	35.00.005.01.04
EM BOX 3H 5,4W DALI	45x120x360 mm	35.00.005.01.05

OPTIONS

EMERGENCY

1 Hour, 3 Hours
 DALI 1 Hour, 3 Hours

CUT OUT

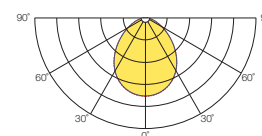
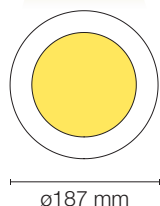
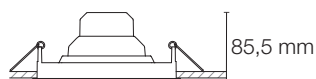
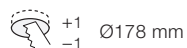

SIRIUS-R RO

ADJUSTABLE RECESSED



PT

- Downlight orientável para aplicação encastrada em interiores.
- Mecanismo articulado que permite a inclinação até 30° em dois eixos.
- Versões CRI >80 ou CRI >90 com elevada restituição cromática.
- Três opções de ângulo de abertura do feixe.
- Luminária com fonte de alimentação incluída.
- Com molas de fixação rápida para instalação sem ferramentas.
- Aro de remate em alumínio com revestimento a epoxy-poliéster.

EN

- Directional downlight for recessed mounting in interior spaces.
- Pivoting mechanism allowing 30° tilt in two axes.
- Choice of CRI >80 or CRI >90 for very good colour rendering.
- Three different beam opening angles.
- Luminaire with included power supply.
- Tool free spring clip installation, directly out of the box.
- Epoxy-polyester powder coated aluminium rim.

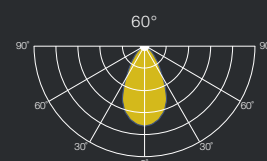
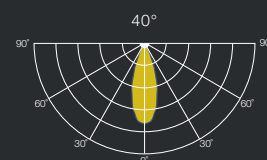
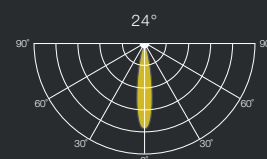
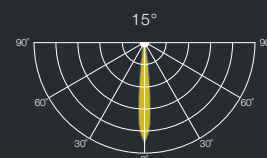

QUICK INFO

GENERAL

Recessed
IP20
IK05
650°C
Class II
Ta= -20°C +35°C

LIGHT SOURCE

LED Modules

SPECIFICATIONS

Efficacy up to 127 lm/W
3000 K, 4000 K
CRI >80, CRI >90
Lifetime 50 000 H
L70/B10 @Tc=55°C

ELECTRICAL SYSTEM

220-240V/50-60Hz
ON/OFF, DALI

FINISHING

RAL 9003 Matt White

OPTIONS

EMERGENCY

1 Hour, 3 Hours
DALI 1 Hour, 3 Hours

CUT OUT

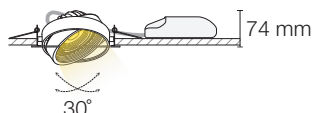
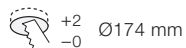

∅184 mm

SIRIUS-R 184 RO ADJUSTABLE RECESSED

CRI >80

Color Temp.	Beam (°)	Output (lm)	System (W)	ON/OFF	DALI	
3000 K	15°	2700	29	33.92.012.08.09	33.92.012.08.66	
	24°	2760	29	33.92.012.08.10	33.92.012.08.67	
		4550	42	33.92.012.08.15	33.92.012.08.72	
	40°	2650	29	33.92.012.08.11	33.92.012.08.68	
		4340	42	33.92.012.08.16	33.92.012.08.73	
4000 K	60°	4240	42	33.92.012.08.17	33.92.012.08.74	
	15°	2830	29	33.92.012.08.12	33.92.012.08.69	
		24°	2900	29	33.92.012.08.13	33.92.012.08.70
			4780	42	33.92.012.08.18	33.92.012.08.75
		40°	2780	29	33.92.012.08.14	33.92.012.08.71
4560			42	33.92.012.08.19	33.92.012.08.76	
60°	4450	42	33.92.012.08.20	33.92.012.08.77		

CRI >90

Color Temp.	Beam (°)	Output (lm)	System (W)	ON/OFF	DALI
2700 K	15°	1730	20	33.92.013.08.58	33.92.013.08.61
	24°	1770	20	33.92.013.08.59	33.92.013.08.62
		1700	20	33.92.013.08.60	33.92.013.08.63
3000 K	15°	1840	20	33.92.012.08.03	33.92.012.08.60
	24°	1880	20	33.92.012.08.04	33.92.012.08.61
		1800	20	33.92.012.08.05	33.92.012.08.62
4000 K	15°	1940	20	33.92.012.08.06	33.92.012.08.63
	24°	1990	20	33.92.012.08.07	33.92.012.08.64
		1910	20	33.92.012.08.08	33.92.012.08.65

— Optionals and External Emergency Box (EM) information on page 060.

OPTIONS



EXTERNAL EMERGENCY BOX (EM)

ON/OFF	REST MODE	DIMENSION	COD
EM BOX 1H 3W	6-12 V	45×120×360 mm	35.00.005.01.02
EM BOX 3H 3W	6-12 V	45×120×360 mm	35.00.005.01.03
DALI	DIMENSION	COD	
EM BOX 1H 5,4W DALI	45×120×360 mm	35.00.005.01.04	
EM BOX 3H 5,4W DALI	45×120×360 mm	35.00.005.01.05	

SIRIUS-R SQ SINGLE ADJUSTABLE RECESSED



PT

- Downlight orientável em versão Single para aplicação encastrada.
- Mecanismo articulado que permite a inclinação até 30° em dois eixos.
- Versões CRI >80 ou CRI >90 com elevada restituição cromática.
- Três opções de ângulo de abertura do feixe.
- Luminária com fonte de alimentação incluída.
- Com molas de fixação rápida para instalação sem ferramentas.
- Aro de remate em alumínio com revestimento a epoxy-poliéster.

EN

- Directional downlight in Single version for recessed mounting.
- Pivoting mechanism allowing 30° tilt in two axes.
- Choice of CRI >80 or CRI >90 for very good colour rendering.
- Three different beam opening angles.
- Luminaire with included power supply.
- Tool free spring clip installation, directly out of the box.
- Epoxy-polyester powder coated aluminium rim.

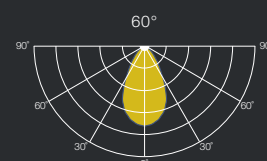
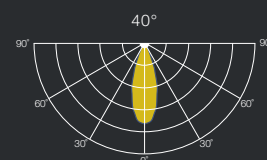
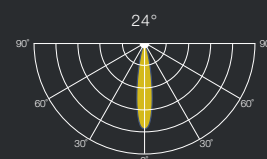
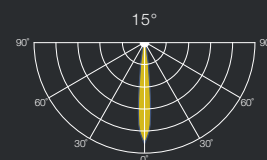

QUICK INFO

GENERAL

Recessed
IP20
IK05
650°C
Class II
Ta= -20°C +35°C

LIGHT SOURCE

LED Modules

SPECIFICATIONS

Efficacy up to 127 lm/W
3000 K, 4000 K
CRI >80, CRI >90
Lifetime 50 000 H
L70/B10 @Tc=55°C

ELECTRICAL SYSTEM

220-240V/50-60Hz
ON/OFF, DALI

FINISHING

RAL 9003 Matt White

OPTIONS

EMERGENCY

1 Hour, 3 Hours
DALI 1 Hour, 3 Hours

CUT OUT

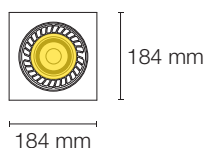
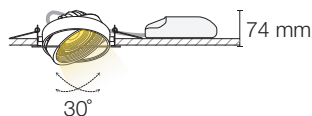
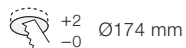

SIRIUS-R SQ SINGLE ADJUSTABLE RECESSED

CRI >80

Color Temp.	Beam (°)	Output (lm)	System (W)	ON/OFF	DALI	
3000 K	15°	2700	29	33.92.012.08.27	33.92.012.08.84	
	24°	2760	29	33.92.012.08.28	33.92.012.08.85	
		4550	42	33.92.012.08.33	33.92.012.08.90	
	40°	2650	29	33.92.012.08.29	33.92.012.08.86	
		4340	42	33.92.012.08.34	33.92.012.08.91	
4000 K	60°	4240	42	33.92.012.08.35	33.92.012.08.92	
	15°	2830	29	33.92.012.08.30	33.92.012.08.87	
		24°	2900	29	33.92.012.08.31	33.92.012.08.88
			4780	42	33.92.012.08.36	33.92.012.08.93
		40°	2780	29	33.92.012.08.32	33.92.012.08.89
4560			42	33.92.012.08.37	33.92.012.08.94	
60°	4450	42	33.92.012.08.38	33.92.012.08.95		

CRI >90

Color Temp.	Beam (°)	Output (lm)	System (W)	ON/OFF	DALI
2700 K	15°	1730	20	33.92.013.08.64	33.92.013.08.70
	24°	1770	20	33.92.013.08.65	33.92.013.08.71
	40°	1700	20	33.92.013.08.66	33.92.013.08.72
3000 K	15°	1840	20	33.92.012.08.21	33.92.012.08.78
	24°	1880	20	33.92.012.08.22	33.92.012.08.79
	40°	1800	20	33.92.012.08.23	33.92.012.08.80
4000 K	15°	1940	20	33.92.012.08.24	33.92.012.08.81
	24°	1990	20	33.92.012.08.25	33.92.012.08.82
	40°	1910	20	33.92.012.08.26	33.92.012.08.83

— External Emergency Box (EM) information on page 060.

OPTIONS



EXTERNAL EMERGENCY BOX (EM)

ON/OFF	REST MODE	DIMENSION	COD
EM BOX 1H 3W	6-12 V	45×120×360 mm	35.00.005.01.02
EM BOX 3H 3W	6-12 V	45×120×360 mm	35.00.005.01.03
DALI	DIMENSION	COD	
EM BOX 1H 5,4W DALI	45×120×360 mm	35.00.005.01.04	
EM BOX 3H 5,4W DALI	45×120×360 mm	35.00.005.01.05	

SIRIUS-R SQ DUO

ADJUSTABLE RECESSED



PT

- Downlight orientável em versão Duo para aplicação encastrada.
- Mecanismo articulado que permite a inclinação até 30° em dois eixos.
- Versões CRI >80 ou CRI >90 com elevada restituição cromática.
- Três opções de ângulo de abertura do feixe.
- Luminária com fonte de alimentação incluída.
- Com molas de fixação rápida para instalação sem ferramentas.
- Aro de remate em alumínio com revestimento a epoxy-poliéster.

EN

- Directional downlight in Duo version for recessed mounting.
- Pivoting mechanism allowing 30° tilt in two axes.
- Choice of CRI >80 or CRI >90 for very good colour rendering.
- Three different beam opening angles.
- Luminaire with included power supply.
- Tool free spring clip installation, directly out of the box.
- Epoxy-polyester powder coated aluminium rim.

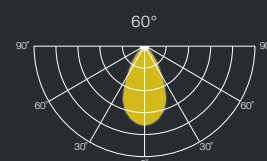
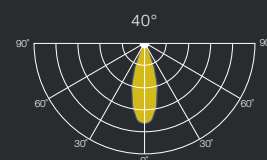
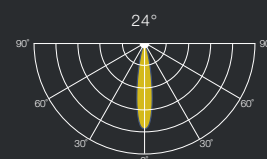
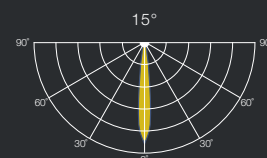

QUICK INFO

GENERAL

Recessed
IP20
IK05
650°C
Class II
Ta= -20°C +35°C

LIGHT SOURCE

LED Modules

SPECIFICATIONS

Efficacy up to 127 lm/W
3000 K, 4000 K
CRI >80, CRI >90
Lifetime 50 000 H
L70/B10 @Tc=55°C

ELECTRICAL SYSTEM

220-240V/50-60Hz
ON/OFF, DALI

FINISHING

RAL 9003 Matt White

OPTIONS

EMERGENCY

1 Hour, 3 Hours
DALI 1 Hour, 3 Hours

CUT OUT

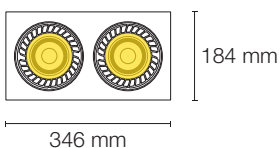
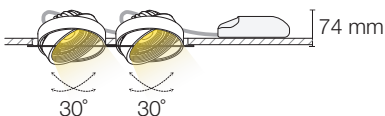

SIRIUS-R SQ DUO ADJUSTABLE RECESSED

CRI >80

Color Temp.	Beam (°)	Output (lm)	System (W)	ON/OFF	DALI
3000 K	15°	5400	57	33.92.012.08.45	33.92.013.08.02
	24°	5520	57	33.92.012.08.46	33.92.013.08.03
		9100	83	33.92.012.08.51	33.92.013.08.08
	40°	5300	57	33.92.012.08.47	33.92.013.08.04
		8680	83	33.92.012.08.52	33.92.013.08.09
4000 K	60°	8480	83	33.92.012.08.53	33.92.013.08.10
	15°	5660	57	33.92.012.08.48	33.92.013.08.05
		5800	57	33.92.012.08.49	33.92.013.08.06
		9560	83	33.92.012.08.54	33.92.013.08.11
	40°	5560	57	33.92.012.08.50	33.92.013.08.07
9120		83	33.92.012.08.55	33.92.013.08.12	
60°	8900	83	33.92.012.08.56	33.92.013.08.13	

CRI >90

Color Temp.	Beam (°)	Output (lm)	System (W)	ON/OFF	DALI
2700 K	15°	3460	40	33.92.013.08.67	33.92.013.08.73
	24°	3540	40	33.92.013.08.68	33.92.013.08.74
	40°	3400	40	33.92.013.08.69	33.92.013.08.75
3000 K	15°	3680	40	33.92.012.08.39	33.92.012.08.96
	24°	3760	40	33.92.012.08.40	33.92.012.08.97
	40°	3600	40	33.92.012.08.41	33.92.012.08.98
4000 K	15°	3880	40	33.92.012.08.42	33.92.012.08.99
	24°	3980	40	33.92.012.08.43	33.92.013.08.00
	40°	3820	40	33.92.012.08.44	33.92.013.08.01

— External Emergency Box (EM) information on page 060.

OPTIONS



EXTERNAL EMERGENCY BOX (EM)

ON/OFF	REST MODE	DIMENSION	COD
EM BOX 1H 3W	6-12 V	45x120x360 mm	35.00.005.01.02
EM BOX 3H 3W	6-12 V	45x120x360 mm	35.00.005.01.03
DALI		DIMENSION	COD
EM BOX 1H 5,4W DALI		45x120x360 mm	35.00.005.01.04
EM BOX 3H 5,4W DALI		45x120x360 mm	35.00.005.01.05

SIRIUS-R R111

ADJUSTABLE RECESSED

PRODUCTS WITHOUT ELECTRONIC COMPONENTS

RO



SIRIUS-R RO R111 without socket

SQ SINGLE



SIRIUS-R SQ SINGLE R111 without socket

SQ DUO



SIRIUS-R SQ DUO R111 without socket

TYPE	DIMENSION	WHITE	BLACK
RO - SIRIUS-R RO R111 Recessed	Ø184 mm	35.92.004.01.30	35.92.004.01.31
SQ SINGLE - SIRIUS-R SQ Single R111 Recessed	184x184 mm	35.92.004.01.32	35.92.004.01.33
SQ DUO - SIRIUS-R SQ Duo R111 Recessed	184x346 mm	35.92.004.01.34	35.92.004.01.35

OPTIONS



1

SUPPORT SET + CABLE BLOCK (1pc)

TYPE	FIG	COD
G53	1	35.92.004.01.37
GU10	2	35.92.004.01.36



2

SIRIUS-R RO R111

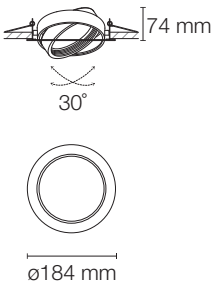

SIRIUS-R SQ SINGLE R111

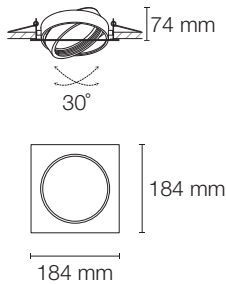

SIRIUS-R SQ DUO R111

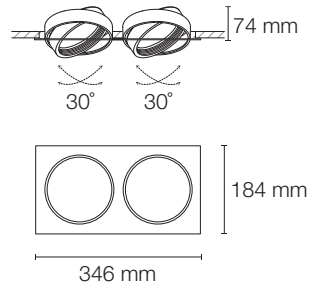





MINI PROFILES

NANO-S17
SURFACE



NANO CORNER
SURFACE



NANO-R14
RECESSED



NANO-T14
TRIMLESS



NANO EDGE
TRIMLESS



NANO-S17 IP40, IP65

SURFACE



PT

- Luminária LED em perfil de alumínio desenvolvida para criar contornos e linhas de luz, ideais para destacar elementos arquitetónicos.
- Para aplicação saliente com possibilidade de aplicação suspensa utilizando acessórios opcionais.
- Disponível em versões IP65 para locais com humidade ou sujeitos a condensações.
- Sistema de clipagem incluído para aplicação saliente rápida e sem ferramentas.
- Driver externo de tensão constante e classe de proteção II.
- Difusor em Policarbonato Opal e corpo em perfil de alumínio.
- Disponível em vários comprimentos, temperaturas de cor e potências de LED para se adequar às mais diversas aplicações.

EN

- Aluminium profile LED luminaire designed to create light lines and contours, ideal for highlighting architectural elements.
- For surface mounting with possibility of suspended mounting with optional accessories.
- An IP65 version is available for damp environments or places prone to condensation.
- Surface mounting quick clamping system included for tool-free installation.
- External class II constant voltage Driver.
- Opal Polycarbonate diffuser and aluminium profile body.
- Available in several lengths, LED colour temperatures and powers to suit most applications.

CEILING APPLICATION



WALL APPLICATION



QUICK INFO

GENERAL

Surface
 IP40
 IK06
 850°C
 Class III
 Ta= -20°C +35°C

OPTIC

Opal Polycarbonate

LIGHT SOURCE

LED Flexible

SPECIFICATIONS

Efficacy up to 135 lm/W
 2700 K, 3000 K, 4000 K
 CRI >80
 Lifetime 30 000 H
 L80/B10 @Tc=55°C
 24 VDC

ELECTRICAL SYSTEM

ON/OFF, DALI
 External Drivers Info - page 107

FINISHING

RAL 9003 Matt White
 Matt Anodized

NANO-S17 SURFACE

OPAL DIFFUSER

		IP40	5 W/m	60 LED/m			
Color T.	W/m	c (mm)	Power (W)	Output (lm)	WHITE	Output (lm)	ANODIZED
2700 K	5	230	1	82	33.41.15.006133	70	33.41.15.006025
		330	1,5	123	33.41.15.006140	105	33.41.15.006032
		430	2	164	33.41.15.006147	140	33.41.15.006039
		530	3	205	33.41.15.005431	174	33.41.15.005305
		1030	5	410	33.41.15.005435	349	33.41.15.005309
		1530	8	616	33.41.15.005439	523	33.41.15.005313
		2030	10	821	33.41.15.005443	698	33.41.15.005317
		2530	13	1026	33.41.15.005447	872	33.41.15.005321
3000 K	5	3030	15	1231	33.41.15.005451	1047	33.41.15.005325
		230	1	85	33.41.15.006154	72	33.41.15.006046
		330	1,5	127	33.41.15.006161	108	33.41.15.006053
		430	2	169	33.41.15.006168	144	33.41.15.006060
		530	3	212	33.41.15.005455	180	33.41.15.005329
		1030	5	423	33.41.15.005459	360	33.41.15.005333
		1530	8	635	33.41.15.005463	540	33.41.15.005337
		2030	10	846	33.41.15.005467	719	33.41.15.005341
4000 K	5	2530	13	1058	33.41.15.005471	899	33.41.15.005345
		3030	15	1269	33.41.15.005475	1079	33.41.15.005349
		230	1	86	33.41.15.006175	73	33.41.15.006067
		330	1,5	129	33.41.15.006182	110	33.41.15.006074
		430	2	173	33.41.15.006189	147	33.41.15.006081
		530	3	216	33.41.15.005479	183	33.41.15.005353
		1030	5	432	33.41.15.005483	367	33.41.15.005357
		1530	8	647	33.41.15.005487	550	33.41.15.005361
2030	10	863	33.41.15.005491	734	33.41.15.005365		
2530	13	1079	33.41.15.005495	917	33.41.15.005369		
3030	15	1295	33.41.15.005499	1101	33.41.15.005373		

— External Driver information on page 107.

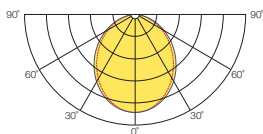

LIGHTING DETAIL



▲ 5 W/m | 60 LED/m



▲ 8, 12, 22 W/m | 120 LED/m

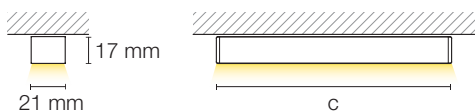

QUICK INFO

GENERAL

Surface
IP40
IK06
850°C
Class III
Ta= -20°C +35°C

OPTIC

Opal Polycarbonate

LIGHT SOURCE

LED Flexible

SPECIFICATIONS

Efficacy up to 135 lm/W
2700 K, 3000 K, 4000 K
CRI >80
Lifetime 30 000 H
L80/B10 @TC=55°C
24 VDC

ELECTRICAL SYSTEM

ON/OFF, DALI
External Drivers Info - page 107

FINISHING

RAL 9003 Matt White
Matt Anodized

NANO-S17 SURFACE

OPAL DIFFUSER

		IP40	8 W/m	120 LED/m					
Color T.	W/m	c (mm)	Power (W)	Output (lm)	WHITE	Output (lm)	ANODIZED		
2700 K	8	230	1,6	140	33.41.15.006134	119	33.41.15.006026		
		280	2	176	33.41.15.006137	149	33.41.15.006029		
		330	2,4	211	33.41.15.006141	179	33.41.15.006033		
		380	2,8	246	33.41.15.006144	209	33.41.15.006036		
		430	3,2	281	33.41.15.006148	239	33.41.15.006040		
		480	3,6	316	33.41.15.006151	269	33.41.15.006043		
		530	4	351	33.41.15.005432	299	33.41.15.005306		
		1030	8	702	33.41.15.005436	597	33.41.15.005310		
		1530	12	1053	33.41.15.005440	896	33.41.15.005314		
		2030	16	1405	33.41.15.005444	1194	33.41.15.005318		
		2530	20	1756	33.41.15.005448	1493	33.41.15.005322		
		3030	24	2107	33.41.15.005452	1791	33.41.15.005326		
		3000 K	8	230	1,6	144	33.41.15.006155	122	33.41.15.006047
				280	2	180	33.41.15.006158	153	33.41.15.006050
				330	2,4	216	33.41.15.006162	183	33.41.15.006054
380	2,8			252	33.41.15.006165	214	33.41.15.006057		
430	3,2			288	33.41.15.006169	245	33.41.15.006061		
480	3,6			324	33.41.15.006172	275	33.41.15.006064		
530	4			360	33.41.15.005456	306	33.41.15.005330		
1030	8			719	33.41.15.005460	611	33.41.15.005334		
1530	12			1079	33.41.15.005464	917	33.41.15.005338		
2030	16			1438	33.41.15.005468	1223	33.41.15.005342		
2530	20			1798	33.41.15.005472	1529	33.41.15.005346		
3030	24			2158	33.41.15.005476	1834	33.41.15.005350		
4000 K	8			230	1,6	151	33.41.15.006176	128	33.41.15.006068
				280	2	188	33.41.15.006179	160	33.41.15.006071
				330	2,4	226	33.41.15.006183	192	33.41.15.006075
		380	2,8	264	33.41.15.006186	224	33.41.15.006078		
		430	3,2	301	33.41.15.006190	256	33.41.15.006082		
		480	3,6	339	33.41.15.006193	288	33.41.15.006085		
		530	4	377	33.41.15.005480	320	33.41.15.005354		
		1030	8	753	33.41.15.005484	640	33.41.15.005358		
		1530	12	1130	33.41.15.005488	960	33.41.15.005362		
		2030	16	1506	33.41.15.005492	1280	33.41.15.005366		
		2530	20	1883	33.41.15.005496	1601	33.41.15.005370		
		3030	24	2259	33.41.15.005500	1921	33.41.15.005374		

— External Driver information on page 107.

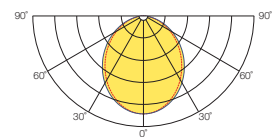
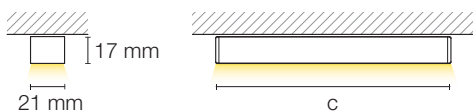

QUICK INFO

GENERAL

Surface
IP40
IK06
850°C
Class III
Ta= -20°C +35°C

OPTIC

Opal Polycarbonate

LIGHT SOURCE

LED Flexible

SPECIFICATIONS

Efficacy up to 135 lm/W
2700 K, 3000 K, 4000 K
CRI >80
Lifetime 30 000 H
L80/B10 @Tc=55°C
24 VDC

ELECTRICAL SYSTEM

ON/OFF, DALI
External Drivers Info - page 107

FINISHING

RAL 9003 Matt White
Matt Anodized

NANO-S17 SURFACE

OPAL DIFFUSER

		IP40	12 W/m	120 LED/m			
Color T.	W/m	c (mm)	Power (W)	Output (lm)	WHITE	Output (lm)	ANODIZED
2700 K	12	230	2,4	186	33.41.15.006135	158	33.41.15.006027
		280	3	233	33.41.15.006138	198	33.41.15.006030
		330	3,6	279	33.41.15.006142	237	33.41.15.006034
		380	4,2	326	33.41.15.006145	277	33.41.15.006037
		430	4,8	372	33.41.15.006149	317	33.41.15.006041
		480	5,4	419	33.41.15.006152	356	33.41.15.006044
		530	6	465	33.41.15.005433	396	33.41.15.005307
		1030	12	931	33.41.15.005437	791	33.41.15.005311
		1530	18	1396	33.41.15.005441	1187	33.41.15.005315
		2030	24	1862	33.41.15.005445	1583	33.41.15.005319
		2530	30	2327	33.41.15.005449	1978	33.41.15.005323
		3030	36	2792	33.41.15.005453	2374	33.41.15.005327
3000 K	12	230	2,4	195	33.41.15.006156	165	33.41.15.006048
		280	3	243	33.41.15.006159	207	33.41.15.006051
		330	3,6	292	33.41.15.006163	248	33.41.15.006055
		380	4,2	341	33.41.15.006166	290	33.41.15.006058
		430	4,8	389	33.41.15.006170	331	33.41.15.006062
		480	5,4	438	33.41.15.006173	372	33.41.15.006065
		530	6	487	33.41.15.005457	414	33.41.15.005331
		1030	12	973	33.41.15.005461	827	33.41.15.005335
		1530	18	1460	33.41.15.005465	1241	33.41.15.005339
		2030	24	1946	33.41.15.005469	1655	33.41.15.005343
		2530	30	2433	33.41.15.005473	2068	33.41.15.005347
		3030	36	2919	33.41.15.005477	2482	33.41.15.005351
4000 K	12	230	2,4	203	33.41.15.006177	173	33.41.15.006069
		280	3	254	33.41.15.006180	216	33.41.15.006072
		330	3,6	305	33.41.15.006184	259	33.41.15.006076
		380	4,2	355	33.41.15.006187	302	33.41.15.006079
		430	4,8	406	33.41.15.006191	345	33.41.15.006083
		480	5,4	457	33.41.15.006194	388	33.41.15.006086
		530	6	508	33.41.15.005481	432	33.41.15.005355
		1030	12	1015	33.41.15.005485	863	33.41.15.005359
		1530	18	1523	33.41.15.005489	1295	33.41.15.005363
		2030	24	2031	33.41.15.005493	1726	33.41.15.005367
		2530	30	2539	33.41.15.005497	2158	33.41.15.005371
		3030	36	3046	33.41.15.005501	2590	33.41.15.005375

— External Driver information on page 107.

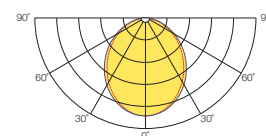
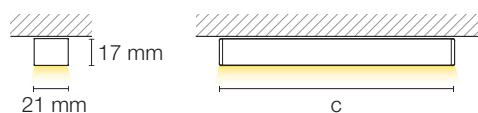

QUICK INFO

GENERAL

Surface
 IP40
 IK06
 850°C
 Class III
 Ta= -20°C +35°C

OPTIC

Opal Polycarbonate

LIGHT SOURCE

LED Flexible

SPECIFICATIONS

Efficacy up to 135 lm/W
 2700 K, 3000 K, 4000 K
 CRI >80
 Lifetime 30 000 H
 L80/B10 @TC=55°C
 24 VDC

ELECTRICAL SYSTEM

ON/OFF, DALI
 External Drivers Info - page 107

FINISHING

RAL 9003 Matt White
 Matt Anodized

NANO-S17 SURFACE

OPAL DIFFUSER

		IP40	22 W/m	120 LED/m			
Color T.	W/m	c (mm)	Power (W)	Output (lm)	WHITE	Output (lm)	ANODIZED
2700 K	22	230	4,4	349	33.41.15.006136	296	33.41.15.006028
		280	5,5	436	33.41.15.006139	370	33.41.15.006031
		330	6,6	523	33.41.15.006143	445	33.41.15.006035
		380	7,7	610	33.41.15.006146	519	33.41.15.006038
		430	8,8	697	33.41.15.006150	593	33.41.15.006042
		480	9,9	784	33.41.15.006153	667	33.41.15.006045
		530	11	872	33.41.15.005434	741	33.41.15.005308
		1030	22	1743	33.41.15.005438	1482	33.41.15.005312
		1530	33	2615	33.41.15.005442	2223	33.41.15.005316
		2030	44	3486	33.41.15.005446	2964	33.41.15.005320
		2530	55	4358	33.41.15.005450	3705	33.41.15.005324
		3030	66	5229	33.41.15.005454	4446	33.41.15.005328
3000 K	22	230	4,4	363	33.41.15.006157	309	33.41.15.006049
		280	5,5	454	33.41.15.006160	386	33.41.15.006052
		330	6,6	545	33.41.15.006164	463	33.41.15.006056
		380	7,7	635	33.41.15.006167	540	33.41.15.006059
		430	8,8	726	33.41.15.006171	617	33.41.15.006063
		480	9,9	817	33.41.15.006174	694	33.41.15.006066
		530	11	908	33.41.15.005458	772	33.41.15.005332
		1030	22	1815	33.41.15.005462	1543	33.41.15.005336
		1530	33	2723	33.41.15.005466	2315	33.41.15.005340
		2030	44	3630	33.41.15.005470	3086	33.41.15.005344
		2530	55	4538	33.41.15.005474	3858	33.41.15.005348
		3030	66	5445	33.41.15.005478	4629	33.41.15.005352
4000 K	22	230	4,4	372	33.41.15.006178	317	33.41.15.006070
		280	5,5	465	33.41.15.006181	396	33.41.15.006073
		330	6,6	558	33.41.15.006185	475	33.41.15.006077
		380	7,7	652	33.41.15.006188	554	33.41.15.006080
		430	8,8	745	33.41.15.006192	633	33.41.15.006084
		480	9,9	838	33.41.15.006195	712	33.41.15.006087
		530	11	931	33.41.15.005482	791	33.41.15.005356
		1030	22	1862	33.41.15.005486	1583	33.41.15.005360
		1530	33	2792	33.41.15.005490	2374	33.41.15.005364
		2030	44	3723	33.41.15.005494	3165	33.41.15.005368
		2530	55	4654	33.41.15.005498	3956	33.41.15.005372
		3030	66	5585	33.41.15.005502	4748	33.41.15.005376

— External Driver information on page 107.

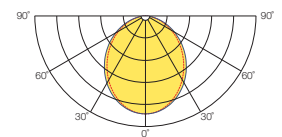
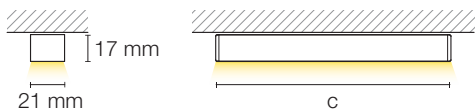

QUICK INFO

GENERAL

Surface
 IP65
 IK06
 850°C
 Class III
 Ta= -20°C +35°C

OPTIC

Opal Polycarbonate

LIGHT SOURCE

LED Flexible

SPECIFICATIONS

Efficacy up to 135 lm/W
 2700 K, 3000 K, 4000 K
 CRI >80
 Lifetime 30 000 H
 L80/B10 @Tc=55°C
 24 VDC

ELECTRICAL SYSTEM

ON/OFF, DALI
 External Drivers Info - page 107

FINISHING

RAL 9003 Matt White
 Matt Anodized

NANO-S17 SURFACE

OPAL DIFFUSER

		IP65	5 W/m	60 LED/m			
Color T.	W/m	c (mm)	Power (W)	Output (lm)	WHITE	Output (lm)	ANODIZED
2700 K	5	235	1	77	33.41.15.006196	66	33.41.15.006088
		335	1,5	115	33.41.15.006201	99	33.41.15.006093
		435	2	154	33.41.15.006206	133	33.41.15.006098
		535	3	192	33.41.15.005503	166	33.41.15.005377
		1035	5	384	33.41.15.005506	332	33.41.15.005380
		1535	8	576	33.41.15.005509	497	33.41.15.005383
		2035	10	768	33.41.15.005512	663	33.41.15.005386
		2535	13	960	33.41.15.005515	829	33.41.15.005389
		3035	15	1152	33.41.15.005518	995	33.41.15.005392
		3000 K	5	235	1	79	33.41.15.006211
335	1,5			119	33.41.15.006216	103	33.41.15.006108
435	2			158	33.41.15.006221	137	33.41.15.006113
535	3			198	33.41.15.005521	171	33.41.15.005395
1035	5			396	33.41.15.005524	342	33.41.15.005398
1535	8			594	33.41.15.005527	513	33.41.15.005401
2035	10			792	33.41.15.005530	684	33.41.15.005404
2535	13			990	33.41.15.005533	855	33.41.15.005407
3035	15			1187	33.41.15.005536	1026	33.41.15.005410
4000 K	5			235	1	81	33.41.15.006226
		335	1,5	121	33.41.15.006231	105	33.41.15.006123
		435	2	161	33.41.15.006236	140	33.41.15.006128
		535	3	202	33.41.15.005539	174	33.41.15.005413
		1035	5	404	33.41.15.005542	349	33.41.15.005416
		1535	8	606	33.41.15.005545	523	33.41.15.005419
		2035	10	807	33.41.15.005548	698	33.41.15.005422
		2535	13	1009	33.41.15.005551	872	33.41.15.005425
		3035	15	1211	33.41.15.005554	1046	33.41.15.005428

— External Driver information on page 107.

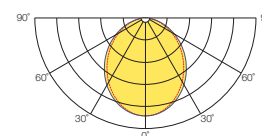
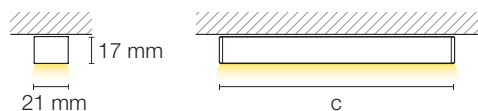

QUICK INFO

GENERAL

Surface
 IP65
 IK06
 850°C
 Class III
 Ta= -20°C +35°C

OPTIC

Opal Polycarbonate

LIGHT SOURCE

LED Flexible

SPECIFICATIONS

Efficacy up to 135 lm/W
 2700 K, 3000 K, 4000 K
 CRI >80
 Lifetime 30 000 H
 L80/B10 @Tc=55°C
 24 VDC

ELECTRICAL SYSTEM

ON/OFF, DALI
 External Drivers Info - page 107

FINISHING

RAL 9003 Matt White
 Matt Anodized

NANO-S17 SURFACE

OPAL DIFFUSER

		IP65	8 W/m	120 LED/m					
Color T.	W/m	c (mm)	Power (W)	Output (lm)	WHITE	Output (lm)	ANODIZED		
2700 K	8	235	1,6	131	33.41.15.006197	114	33.41.15.006089		
		285	2	164	33.41.15.006199	142	33.41.15.006091		
		335	2,4	197	33.41.15.006202	170	33.41.15.006094		
		385	2,8	230	33.41.15.006204	199	33.41.15.006096		
		435	3,2	263	33.41.15.006207	227	33.41.15.006099		
		485	3,6	296	33.41.15.006209	255	33.41.15.006101		
		535	4	329	33.41.15.005504	284	33.41.15.005378		
		1035	8	657	33.41.15.005507	568	33.41.15.005381		
		1535	12	986	33.41.15.005510	851	33.41.15.005384		
		2035	16	1314	33.41.15.005513	1135	33.41.15.005387		
		2535	20	1643	33.41.15.005516	1419	33.41.15.005390		
		3035	24	1971	33.41.15.005519	1703	33.41.15.005393		
		3000 K	8	235	1,6	135	33.41.15.006212	116	33.41.15.006104
				285	2	168	33.41.15.006214	145	33.41.15.006106
				335	2,4	202	33.41.15.006217	174	33.41.15.006109
385	2,8			236	33.41.15.006219	203	33.41.15.006111		
435	3,2			269	33.41.15.006222	233	33.41.15.006114		
485	3,6			303	33.41.15.006224	262	33.41.15.006116		
535	4			336	33.41.15.005522	291	33.41.15.005396		
1035	8			673	33.41.15.005525	581	33.41.15.005399		
1535	12			1009	33.41.15.005528	872	33.41.15.005402		
2035	16			1346	33.41.15.005531	1163	33.41.15.005405		
2535	20			1682	33.41.15.005534	1453	33.41.15.005408		
3035	24			2019	33.41.15.005537	1744	33.41.15.005411		
4000 K	8			235	1,6	141	33.41.15.006227	122	33.41.15.006119
				285	2	176	33.41.15.006229	152	33.41.15.006121
				335	2,4	211	33.41.15.006232	183	33.41.15.006124
		385	2,8	247	33.41.15.006234	213	33.41.15.006126		
		435	3,2	282	33.41.15.006237	243	33.41.15.006129		
		485	3,6	317	33.41.15.006239	274	33.41.15.006131		
		535	4	352	33.41.15.005540	304	33.41.15.005414		
		1035	8	705	33.41.15.005543	609	33.41.15.005417		
		1535	12	1057	33.41.15.005546	913	33.41.15.005420		
		2035	16	1409	33.41.15.005549	1217	33.41.15.005423		
		2535	20	1761	33.41.15.005552	1522	33.41.15.005426		
		3035	24	2114	33.41.15.005555	1826	33.41.15.005429		

— External Driver information on page 107.

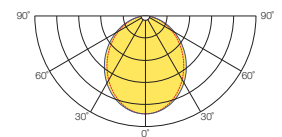
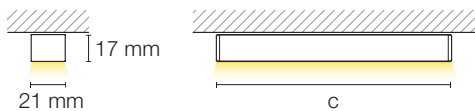

QUICK INFO

GENERAL

Surface
 IP65
 IK06
 850°C
 Class III
 Ta= -20°C +35°C

OPTIC

Opal Polycarbonate

LIGHT SOURCE

LED Flexible

SPECIFICATIONS

Efficacy up to 135 lm/W
 2700 K, 3000 K, 4000 K
 CRI >80
 Lifetime 30 000 H
 L80/B10 @Tc=55°C
 24 VDC

ELECTRICAL SYSTEM

ON/OFF, DALI
 External Drivers Info - page 107

FINISHING

RAL 9003 Matt White
 Matt Anodized

NANO-S17 SURFACE

OPAL DIFFUSER

		IP65	12 W/m	120 LED/m					
Color T.	W/m	c (mm)	Power (W)	Output (lm)	WHITE	Output (lm)	ANODIZED		
2700 K	12	235	2,4	174	33.41.15.006198	150	33.41.15.006090		
		285	3	218	33.41.15.006200	188	33.41.15.006092		
		335	3,6	261	33.41.15.006203	226	33.41.15.006095		
		385	4,2	305	33.41.15.006205	263	33.41.15.006097		
		435	4,8	348	33.41.15.006208	301	33.41.15.006100		
		485	5,4	392	33.41.15.006210	338	33.41.15.006102		
		535	6	435	33.41.15.005505	376	33.41.15.005379		
		1035	12	871	33.41.15.005508	752	33.41.15.005382		
		1535	18	1306	33.41.15.005511	1128	33.41.15.005385		
		2035	24	1742	33.41.15.005514	1504	33.41.15.005388		
		2535	30	2177	33.41.15.005517	1881	33.41.15.005391		
		3035	36	2612	33.41.15.005520	2257	33.41.15.005394		
		3000 K	12	235	2,4	182	33.41.15.006213	157	33.41.15.006105
				285	3	228	33.41.15.006215	197	33.41.15.006107
				335	3,6	273	33.41.15.006218	236	33.41.15.006110
385	4,2			319	33.41.15.006220	275	33.41.15.006112		
435	4,8			364	33.41.15.006223	315	33.41.15.006115		
485	5,4			410	33.41.15.006225	354	33.41.15.006117		
535	6			455	33.41.15.005523	393	33.41.15.005397		
1035	12			910	33.41.15.005526	786	33.41.15.005400		
1535	18			1366	33.41.15.005529	1180	33.41.15.005403		
2035	24			1821	33.41.15.005532	1573	33.41.15.005406		
2535	30			2276	33.41.15.005535	1966	33.41.15.005409		
3035	36			2731	33.41.15.005538	2359	33.41.15.005412		
4000 K	12			235	2,4	190	33.41.15.006228	164	33.41.15.006120
				285	3	237	33.41.15.006230	205	33.41.15.006122
				335	3,6	285	33.41.15.006233	246	33.41.15.006125
		385	4,2	332	33.41.15.006235	287	33.41.15.006127		
		435	4,8	380	33.41.15.006238	328	33.41.15.006130		
		485	5,4	427	33.41.15.006240	369	33.41.15.006132		
		535	6	475	33.41.15.005541	410	33.41.15.005415		
		1035	12	950	33.41.15.005544	821	33.41.15.005418		
		1535	18	1425	33.41.15.005547	1231	33.41.15.005421		
		2035	24	1900	33.41.15.005550	1641	33.41.15.005424		
		2535	30	2375	33.41.15.005553	2051	33.41.15.005427		
		3035	36	2850	33.41.15.005556	2462	33.41.15.005430		

— External Driver information on page 107.

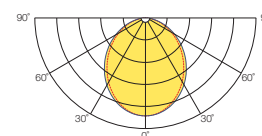
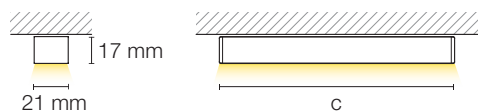

NANO CORNER IP40, IP65 SURFACE



PT

- Luminária LED em perfil de alumínio para aplicação saliente de canto.
- Ideal para montagem sob armários e prateleiras ou na junção parede/teto em cozinhas, casas de banho, salas de exposição, etc.
- Disponível em versões IP65 para locais com humidade ou sujeitos a condensações.
- Sistema de clipagem incluído para instalação rápida e sem ferramentas.
- Driver externo de tensão constante e classe de proteção II.
- Difusor em Policarbonato Opal e corpo em perfil de alumínio de formato triangular.
- Em vários comprimentos, temperaturas de cor e potências de LED para se adequar às mais diversas aplicações.

EN

- Surface mounted LED aluminium corner profile LED luminaire.
- Ideal for mounting under cabinets and shelving or at wall/ceiling joins around kitchens, bathrooms, showrooms, etc.
- Small aluminium profile with a very narrow width.
- An IP65 version is available for damp environments or places prone to condensation.
- Quick clamping system included for tool-free installation.
- External class II constant voltage Driver.
- Opal Polycarbonate diffuser and triangular-shaped aluminium profile body.
- Available in several lengths, LED colour temperatures and powers to suit most applications.

QUICK INFO

GENERAL

Corner Surface
 IP40
 IK06
 850°C
 Class III
 Ta= -20°C +35°C

OPTIC

Opal Polycarbonate

LIGHT SOURCE

LED Flexible

SPECIFICATIONS

Efficacy up to 135 lm/W
 2700 K, 3000 K, 4000 K
 CRI >80
 Lifetime 30 000 H
 L80/B10 @Tc=55°C
 24 VDC

ELECTRICAL SYSTEM

ON/OFF, DALI
 External Drivers Info - page 107

FINISHING

RAL 9003 Matt White
 Matt Anodized

**NANO CORNER SURFACE
 OPAL DIFFUSER**

		IP40	5 W/m	60 LED/m			
Color T.	W/m	c (mm)	Power (W)	Output (lm)	WHITE	Output (lm)	ANODIZED
2700 K	5	230	1	72	33.41.15.006565	67	33.41.15.006457
		330	1,5	107	33.41.15.006572	100	33.41.15.006464
		430	2	143	33.41.15.006579	133	33.41.15.006471
		530	3	179	33.41.15.004927	166	33.41.15.004801
		1030	5	358	33.41.15.004931	333	33.41.15.004805
		1530	8	537	33.41.15.004935	499	33.41.15.004809
		2030	10	716	33.41.15.004939	666	33.41.15.004813
		2530	13	895	33.41.15.004943	832	33.41.15.004817
		3030	15	1075	33.41.15.004947	999	33.41.15.004821
		3000 K	5	230	1	74	33.41.15.006586
330	1,5			111	33.41.15.006593	103	33.41.15.006485
430	2			148	33.41.15.006600	137	33.41.15.006492
530	3			185	33.41.15.004951	172	33.41.15.004825
1030	5			369	33.41.15.004955	343	33.41.15.004829
1530	8			554	33.41.15.004959	515	33.41.15.004833
2030	10			739	33.41.15.004963	687	33.41.15.004837
2530	13			923	33.41.15.004967	858	33.41.15.004841
3030	15			1108	33.41.15.004971	1030	33.41.15.004845
4000 K	5			230	1	75	33.41.15.006607
		330	1,5	113	33.41.15.006614	105	33.41.15.006506
		430	2	151	33.41.15.006621	140	33.41.15.006513
		530	3	188	33.41.15.004975	175	33.41.15.004849
		1030	5	377	33.41.15.004979	350	33.41.15.004853
		1530	8	565	33.41.15.004983	525	33.41.15.004857
		2030	10	753	33.41.15.004987	700	33.41.15.004861
		2530	13	942	33.41.15.004991	875	33.41.15.004865
		3030	15	1130	33.41.15.004995	1050	33.41.15.004869

— External Driver information on page 107.

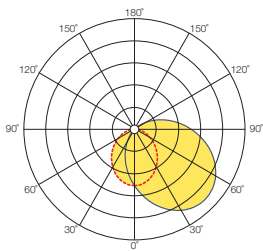

LIGHTING DETAIL



▲ 5 W/m | 60 LED/m



▲ 8, 12, 22 W/m | 120 LED/m

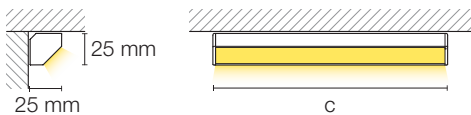

QUICK INFO

GENERAL

Corner Surface
IP40
IK06
850°C
Class III
Ta= -20°C +35°C

OPTIC

Opal Polycarbonate

LIGHT SOURCE

LED Flexible

SPECIFICATIONS

Efficacy up to 135 lm/W
2700 K, 3000 K, 4000 K
CRI >80
Lifetime 30 000 H
L80/B10 @TC=55°C
24 VDC

ELECTRICAL SYSTEM

ON/OFF, DALI
External Drivers Info - page 107

FINISHING

RAL 9003 Matt White
Matt Anodized

NANO CORNER SURFACE
OPAL DIFFUSER

IP40 8 W/m 120 LED/m

Color T.	W/m	c (mm)	Power (W)	Output (lm)	WHITE	Output (lm)	ANODIZED		
2700 K	8	230	1,6	123	33.41.15.006566	114	33.41.15.006458		
		280	2	153	33.41.15.006569	142	33.41.15.006461		
		330	2,4	184	33.41.15.006573	171	33.41.15.006465		
		380	2,8	215	33.41.15.006576	199	33.41.15.006468		
		430	3,2	245	33.41.15.006580	228	33.41.15.006472		
		480	3,6	276	33.41.15.006583	256	33.41.15.006475		
		530	4	306	33.41.15.004928	285	33.41.15.004802		
		1030	8	613	33.41.15.004932	570	33.41.15.004806		
		1530	12	919	33.41.15.004936	855	33.41.15.004810		
		2030	16	1226	33.41.15.004940	1140	33.41.15.004814		
		2530	20	1532	33.41.15.004944	1425	33.41.15.004818		
		3030	24	1839	33.41.15.004948	1709	33.41.15.004822		
		3000 K	8	230	1,6	126	33.41.15.006587	117	33.41.15.006479
				280	2	157	33.41.15.006590	146	33.41.15.006482
				330	2,4	188	33.41.15.006594	175	33.41.15.006486
380	2,8			220	33.41.15.006597	204	33.41.15.006489		
430	3,2			251	33.41.15.006601	233	33.41.15.006493		
480	3,6			282	33.41.15.006604	263	33.41.15.006496		
530	4			314	33.41.15.004952	292	33.41.15.004826		
1030	8			628	33.41.15.004956	584	33.41.15.004830		
1530	12			942	33.41.15.004960	875	33.41.15.004834		
2030	16			1256	33.41.15.004964	1167	33.41.15.004838		
2530	20			1569	33.41.15.004968	1459	33.41.15.004842		
3030	24			1883	33.41.15.004972	1751	33.41.15.004846		
4000 K	8			230	1,6	131	33.41.15.006608	122	33.41.15.006500
				280	2	164	33.41.15.006611	153	33.41.15.006503
				330	2,4	197	33.41.15.006615	183	33.41.15.006507
		380	2,8	230	33.41.15.006618	214	33.41.15.006510		
		430	3,2	263	33.41.15.006622	244	33.41.15.006514		
		480	3,6	296	33.41.15.006625	275	33.41.15.006517		
		530	4	329	33.41.15.004976	306	33.41.15.004850		
		1030	8	657	33.41.15.004980	611	33.41.15.004854		
		1530	12	986	33.41.15.004984	917	33.41.15.004858		
		2030	16	1315	33.41.15.004988	1222	33.41.15.004862		
		2530	20	1643	33.41.15.004992	1528	33.41.15.004866		
		3030	24	1972	33.41.15.004996	1833	33.41.15.004870		

— External Driver information on page 107.

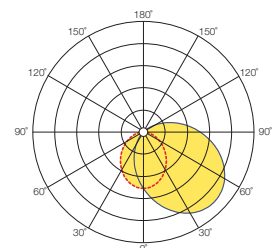
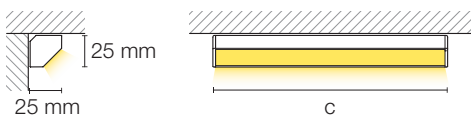

QUICK INFO

GENERAL

Corner Surface
IP40
IK06
850°C
Class III
Ta= -20°C +35°C

OPTIC

Opal Polycarbonate

LIGHT SOURCE

LED Flexible

SPECIFICATIONS

Efficacy up to 135 lm/W
2700 K, 3000 K, 4000 K
CRI >80
Lifetime 30 000 H
L80/B10 @Tc=55°C
24 VDC

ELECTRICAL SYSTEM

ON/OFF, DALI
External Drivers Info - page 107

FINISHING

RAL 9003 Matt White
Matt Anodized

NANO CORNER SURFACE
OPAL DIFFUSER

		IP40	12 W/m	120 LED/m			
Color T.	W/m	c (mm)	Power (W)	Output (lm)	WHITE	Output (lm)	ANODIZED
2700 K	12	230	2,4	162	33.41.15.006567	151	33.41.15.006459
		280	3	203	33.41.15.006570	189	33.41.15.006462
		330	3,6	244	33.41.15.006574	227	33.41.15.006466
		380	4,2	284	33.41.15.006577	264	33.41.15.006469
		430	4,8	325	33.41.15.006581	302	33.41.15.006473
		480	5,4	366	33.41.15.006584	340	33.41.15.006476
		530	6	406	33.41.15.004929	378	33.41.15.004803
		1030	12	812	33.41.15.004933	755	33.41.15.004807
		1530	18	1219	33.41.15.004937	1133	33.41.15.004811
		2030	24	1625	33.41.15.004941	1510	33.41.15.004815
		2530	30	2031	33.41.15.004945	1888	33.41.15.004819
		3030	36	2437	33.41.15.004949	2266	33.41.15.004823
3000 K	12	230	2,4	170	33.41.15.006588	158	33.41.15.006480
		280	3	212	33.41.15.006591	197	33.41.15.006483
		330	3,6	255	33.41.15.006595	237	33.41.15.006487
		380	4,2	297	33.41.15.006598	276	33.41.15.006490
		430	4,8	340	33.41.15.006602	316	33.41.15.006494
		480	5,4	382	33.41.15.006605	355	33.41.15.006497
		530	6	425	33.41.15.004953	395	33.41.15.004827
		1030	12	849	33.41.15.004957	790	33.41.15.004831
		1530	18	1274	33.41.15.004961	1184	33.41.15.004835
		2030	24	1699	33.41.15.004965	1579	33.41.15.004839
		2530	30	2123	33.41.15.004969	1974	33.41.15.004843
		3030	36	2548	33.41.15.004973	2369	33.41.15.004847
4000 K	12	230	2,4	177	33.41.15.006609	165	33.41.15.006501
		280	3	222	33.41.15.006612	206	33.41.15.006504
		330	3,6	266	33.41.15.006616	247	33.41.15.006508
		380	4,2	310	33.41.15.006619	288	33.41.15.006511
		430	4,8	354	33.41.15.006623	330	33.41.15.006515
		480	5,4	399	33.41.15.006626	371	33.41.15.006518
		530	6	443	33.41.15.004977	412	33.41.15.004851
		1030	12	886	33.41.15.004981	824	33.41.15.004855
		1530	18	1329	33.41.15.004985	1236	33.41.15.004859
		2030	24	1772	33.41.15.004989	1648	33.41.15.004863
		2530	30	2216	33.41.15.004993	2060	33.41.15.004867
		3030	36	2659	33.41.15.004997	2472	33.41.15.004871

— External Driver information on page 107.

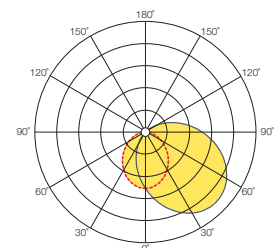
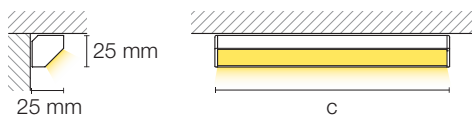

QUICK INFO

GENERAL

Corner Surface
 IP40
 IK06
 850°C
 Class III
 Ta= -20°C +35°C

OPTIC

Opal Polycarbonate

LIGHT SOURCE

LED Flexible

SPECIFICATIONS

Efficacy up to 135 lm/W
 2700 K, 3000 K, 4000 K
 CRI >80
 Lifetime 30 000 H
 L80/B10 @TC=55°C
 24 VDC

ELECTRICAL SYSTEM

ON/OFF, DALI
 External Drivers Info - page 107

FINISHING

RAL 9003 Matt White
 Matt Anodized

**NANO CORNER SURFACE
 OPAL DIFFUSER**

		IP40	22 W/m	120 LED/m					
Color T.	W/m	c (mm)	Power (W)	Output (lm)	WHITE	Output (lm)	ANODIZED		
2700 K	22	230	4,4	304	33.41.15.006568	283	33.41.15.006460		
		280	5,5	380	33.41.15.006571	354	33.41.15.006463		
		330	6,6	456	33.41.15.006575	424	33.41.15.006467		
		380	7,7	532	33.41.15.006578	495	33.41.15.006470		
		430	8,8	609	33.41.15.006582	566	33.41.15.006474		
		480	9,9	685	33.41.15.006585	636	33.41.15.006477		
		530	11	761	33.41.15.004930	707	33.41.15.004804		
		1030	22	1521	33.41.15.004934	1414	33.41.15.004808		
		1530	33	2282	33.41.15.004938	2121	33.41.15.004812		
		2030	44	3043	33.41.15.004942	2829	33.41.15.004816		
		2530	55	3803	33.41.15.004946	3536	33.41.15.004820		
		3030	66	4564	33.41.15.004950	4243	33.41.15.004824		
		3000 K	22	230	4,4	317	33.41.15.006589	295	33.41.15.006481
				280	5,5	396	33.41.15.006592	368	33.41.15.006484
				330	6,6	475	33.41.15.006596	442	33.41.15.006488
380	7,7			554	33.41.15.006599	515	33.41.15.006491		
430	8,8			634	33.41.15.006603	589	33.41.15.006495		
480	9,9			713	33.41.15.006606	663	33.41.15.006498		
530	11			792	33.41.15.004954	736	33.41.15.004828		
1030	22			1584	33.41.15.004958	1473	33.41.15.004832		
1530	33			2376	33.41.15.004962	2209	33.41.15.004836		
2030	44			3168	33.41.15.004966	2945	33.41.15.004840		
2530	55			3960	33.41.15.004970	3682	33.41.15.004844		
3030	66			4752	33.41.15.004974	4418	33.41.15.004848		
4000 K	22			230	4,4	325	33.41.15.006610	302	33.41.15.006502
				280	5,5	406	33.41.15.006613	378	33.41.15.006505
				330	6,6	487	33.41.15.006617	453	33.41.15.006509
		380	7,7	569	33.41.15.006620	529	33.41.15.006512		
		430	8,8	650	33.41.15.006624	604	33.41.15.006516		
		480	9,9	731	33.41.15.006627	680	33.41.15.006519		
		530	11	812	33.41.15.004978	755	33.41.15.004852		
		1030	22	1625	33.41.15.004982	1510	33.41.15.004856		
		1530	33	2437	33.41.15.004986	2266	33.41.15.004860		
		2030	44	3250	33.41.15.004990	3021	33.41.15.004864		
		2530	55	4062	33.41.15.004994	3776	33.41.15.004868		
		3030	66	4874	33.41.15.004998	4531	33.41.15.004872		

— External Driver information on page 107.

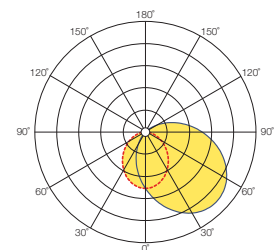
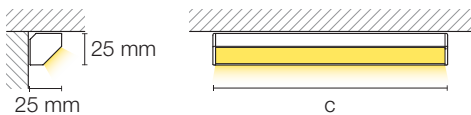

QUICK INFO

GENERAL

Corner Surface
IP65
IK06
850°C
Class III
Ta= -20°C +35°C

OPTIC

Opal Polycarbonate

LIGHT SOURCE

LED Flexible

SPECIFICATIONS

Efficacy up to 135 lm/W
2700 K, 3000 K, 4000 K
CRI >80
Lifetime 30 000 H
L80/B10 @Tc=55°C
24 VDC

ELECTRICAL SYSTEM

ON/OFF, DALI
External Drivers Info - page 107

FINISHING

RAL 9003 Matt White
Matt Anodized

NANO CORNER SURFACE

OPAL DIFFUSER

		IP65	5 W/m	60 LED/m			
Color T.	W/m	c (mm)	Power (W)	Output (lm)	WHITE	Output (lm)	ANODIZED
2700 K	5	235	1	70	33.41.15.006628	64	33.41.15.006520
		335	1,5	106	33.41.15.006633	96	33.41.15.006525
		435	2	141	33.41.15.006638	128	33.41.15.006530
		535	3	176	33.41.15.004999	160	33.41.15.004873
		1035	5	352	33.41.15.005002	321	33.41.15.004876
		1535	8	528	33.41.15.005005	481	33.41.15.004879
		2035	10	703	33.41.15.005008	642	33.41.15.004882
3000 K	5	2535	13	879	33.41.15.005011	802	33.41.15.004885
		3035	15	1055	33.41.15.005014	962	33.41.15.004888
		235	1	73	33.41.15.006643	66	33.41.15.006535
		335	1,5	109	33.41.15.006648	99	33.41.15.006540
		435	2	145	33.41.15.006653	132	33.41.15.006545
		535	3	181	33.41.15.005017	165	33.41.15.004891
		1035	5	363	33.41.15.005020	331	33.41.15.004894
4000 K	5	1535	8	544	33.41.15.005023	496	33.41.15.004897
		2035	10	725	33.41.15.005026	661	33.41.15.004900
		2535	13	906	33.41.15.005029	827	33.41.15.004903
		3035	15	1088	33.41.15.005032	992	33.41.15.004906
		235	1	74	33.41.15.006658	67	33.41.15.006550
		335	1,5	111	33.41.15.006663	101	33.41.15.006555
		435	2	148	33.41.15.006668	135	33.41.15.006560
4000 K	5	535	3	185	33.41.15.005035	169	33.41.15.004909
		1035	5	370	33.41.15.005038	337	33.41.15.004912
		1535	8	555	33.41.15.005041	506	33.41.15.004915
		2035	10	740	33.41.15.005044	675	33.41.15.004918
		2535	13	925	33.41.15.005047	843	33.41.15.004921
		3035	15	1110	33.41.15.005050	1012	33.41.15.004924

— External Driver information on page 107.

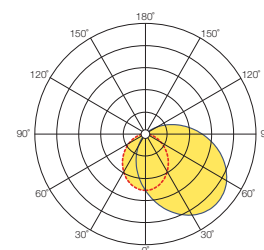
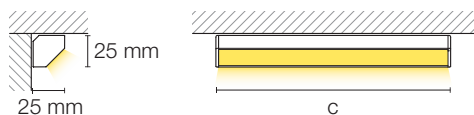

QUICK INFO

GENERAL

Corner Surface
 IP65
 IK06
 850°C
 Class III
 Ta= -20°C +35°C

OPTIC

Opal Polycarbonate

LIGHT SOURCE

LED Flexible

SPECIFICATIONS

Efficacy up to 135 lm/W
 2700 K, 3000 K, 4000 K
 CRI >80
 Lifetime 30 000 H
 L80/B10 @Tc=55°C
 24 VDC

ELECTRICAL SYSTEM

ON/OFF, DALI
 External Drivers Info - page 107

FINISHING

RAL 9003 Matt White
 Matt Anodized

**NANO CORNER SURFACE
 OPAL DIFFUSER**

		IP65	8 W/m	120 LED/m					
Color T.	W/m	c (mm)	Power (W)	Output (lm)	WHITE	Output (lm)	ANODIZED		
2700 K	8	235	1,6	120	33.41.15.006629	110	33.41.15.006521		
		285	2	150	33.41.15.006631	137	33.41.15.006523		
		335	2,4	181	33.41.15.006634	165	33.41.15.006526		
		385	2,8	211	33.41.15.006636	192	33.41.15.006528		
		435	3,2	241	33.41.15.006639	220	33.41.15.006531		
		485	3,6	271	33.41.15.006641	247	33.41.15.006533		
		535	4	301	33.41.15.005000	274	33.41.15.004874		
		1035	8	602	33.41.15.005003	549	33.41.15.004877		
		1535	12	903	33.41.15.005006	823	33.41.15.004880		
		2035	16	1204	33.41.15.005009	1098	33.41.15.004883		
		2535	20	1505	33.41.15.005012	1372	33.41.15.004886		
		3035	24	1806	33.41.15.005015	1647	33.41.15.004889		
		3000 K	8	235	1,6	123	33.41.15.006644	112	33.41.15.006536
				285	2	154	33.41.15.006646	141	33.41.15.006538
				335	2,4	185	33.41.15.006649	169	33.41.15.006541
385	2,8			216	33.41.15.006651	197	33.41.15.006543		
435	3,2			247	33.41.15.006654	225	33.41.15.006546		
485	3,6			277	33.41.15.006656	253	33.41.15.006548		
535	4			308	33.41.15.005018	281	33.41.15.004892		
1035	8			616	33.41.15.005021	562	33.41.15.004895		
1535	12			925	33.41.15.005024	843	33.41.15.004898		
2035	16			1233	33.41.15.005027	1124	33.41.15.004901		
2535	20			1541	33.41.15.005030	1405	33.41.15.004904		
3035	24			1849	33.41.15.005033	1687	33.41.15.004907		
4000 K	8			235	1,6	129	33.41.15.006659	118	33.41.15.006551
				285	2	161	33.41.15.006661	147	33.41.15.006553
				335	2,4	194	33.41.15.006664	177	33.41.15.006556
		385	2,8	226	33.41.15.006666	206	33.41.15.006558		
		435	3,2	258	33.41.15.006669	235	33.41.15.006561		
		485	3,6	290	33.41.15.006671	265	33.41.15.006563		
		535	4	323	33.41.15.005036	294	33.41.15.004910		
		1035	8	645	33.41.15.005039	589	33.41.15.004913		
		1535	12	968	33.41.15.005042	883	33.41.15.004916		
		2035	16	1291	33.41.15.005045	1177	33.41.15.004919		
		2535	20	1614	33.41.15.005048	1472	33.41.15.004922		
		3035	24	1936	33.41.15.005051	1766	33.41.15.004925		

— External Driver information on page 107.

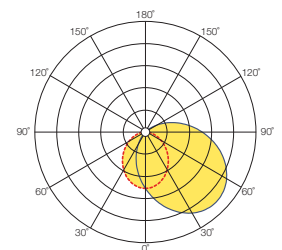
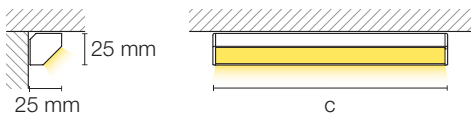

QUICK INFO

GENERAL

Corner Surface
IP65
IK06
850°C
Class III
Ta= -20°C +35°C

OPTIC

Opal Polycarbonate

LIGHT SOURCE

LED Flexible

SPECIFICATIONS

Efficacy up to 135 lm/W
2700 K, 3000 K, 4000 K
CRI >80
Lifetime 30 000 H
L80/B10 @Tc=55°C
24 VDC

ELECTRICAL SYSTEM

ON/OFF, DALI
External Drivers Info - page 107

FINISHING

RAL 9003 Matt White
Matt Anodized

NANO CORNER SURFACE

OPAL DIFFUSER

		IP65	12 W/m	120 LED/m					
Color T.	W/m	c (mm)	Power (W)	Output (lm)	WHITE	Output (lm)	ANODIZED		
2700 K	12	235	2,4	160	33.41.15.006630	146	33.41.15.006522		
		285	3	199	33.41.15.006632	182	33.41.15.006524		
		335	3,6	239	33.41.15.006635	218	33.41.15.006527		
		385	4,2	279	33.41.15.006637	255	33.41.15.006529		
		435	4,8	319	33.41.15.006640	291	33.41.15.006532		
		485	5,4	359	33.41.15.006642	327	33.41.15.006534		
		535	6	399	33.41.15.005001	364	33.41.15.004875		
		1035	12	798	33.41.15.005004	728	33.41.15.004878		
		1535	18	1197	33.41.15.005007	1091	33.41.15.004881		
		2035	24	1595	33.41.15.005010	1455	33.41.15.004884		
		2535	30	1994	33.41.15.005013	1819	33.41.15.004887		
		3035	36	2393	33.41.15.005016	2183	33.41.15.004890		
		3000 K	12	235	2,4	167	33.41.15.006645	152	33.41.15.006537
				285	3	208	33.41.15.006647	190	33.41.15.006539
				335	3,6	250	33.41.15.006650	228	33.41.15.006542
385	4,2			292	33.41.15.006652	266	33.41.15.006544		
435	4,8			334	33.41.15.006655	304	33.41.15.006547		
485	5,4			375	33.41.15.006657	342	33.41.15.006549		
535	6			417	33.41.15.005019	380	33.41.15.004893		
1035	12			834	33.41.15.005022	761	33.41.15.004896		
1535	18			1251	33.41.15.005025	1141	33.41.15.004899		
2035	24			1668	33.41.15.005028	1521	33.41.15.004902		
2535	30			2085	33.41.15.005031	1901	33.41.15.004905		
3035	36			2502	33.41.15.005034	2282	33.41.15.004908		
4000 K	12			235	2,4	174	33.41.15.006660	159	33.41.15.006552
				285	3	218	33.41.15.006662	198	33.41.15.006554
				335	3,6	261	33.41.15.006665	238	33.41.15.006557
		385	4,2	305	33.41.15.006667	278	33.41.15.006559		
		435	4,8	348	33.41.15.006670	317	33.41.15.006562		
		485	5,4	392	33.41.15.006672	357	33.41.15.006564		
		535	6	435	33.41.15.005037	397	33.41.15.004911		
		1035	12	870	33.41.15.005040	794	33.41.15.004914		
		1535	18	1305	33.41.15.005043	1190	33.41.15.004917		
		2035	24	1740	33.41.15.005046	1587	33.41.15.004920		
		2535	30	2176	33.41.15.005049	1984	33.41.15.004923		
		3035	36	2611	33.41.15.005052	2381	33.41.15.004926		

— External Driver information on page 107.

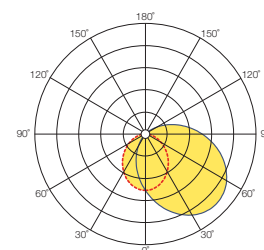
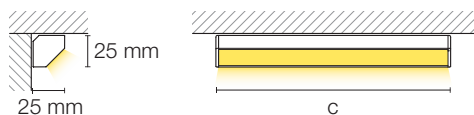

NANO-R14 IP40, IP65 RECESSED



PT

- Luminária LED em perfil de alumínio para aplicação encastrada em tetos, paredes ou prateleiras.
- Perfil de alumínio compacto com uma largura muito reduzida.
- Disponível em versões IP65 para locais com humidade ou sujeitos a condensações.
- Molas de fixação incluídas para instalação rápida e sem ferramentas.
- Driver externo de tensão constante e classe de proteção II.
- Difusor em Policarbonato Opal e corpo em perfil de alumínio.
- Disponível em vários comprimentos, temperaturas de cor e potências de LED para se adequar às mais diversas aplicações.

EN

- Aluminium recessed profile LED luminaire suitable for numerous uses, from ceiling mounting to embedding in walls and shelving.
- Small aluminium profile with a very narrow width.
- An IP65 version is available for damp environments or places prone to condensation.
- Tool free spring clip installation, directly out of the box.
- External class II constant voltage Driver.
- Opal Polycarbonate diffuser and aluminium profile body.
- Available in several lengths, LED colour temperatures and powers to suit most applications.

QUICK INFO

GENERAL

Recessed
 IP40
 IK06
 850°C
 Class III
 Ta= -20°C +35°C

OPTIC

Opal Polycarbonate

LIGHT SOURCE

LED Flexible

SPECIFICATIONS

Efficacy up to 135 lm/W
 2700 K, 3000 K, 4000 K
 CRI >80
 Lifetime 30 000 H
 L80/B10 @Tc=55°C
 24 VDC

ELECTRICAL SYSTEM

ON/OFF, DALI
 External Drivers Info - page 107

FINISHING

RAL 9003 Matt White
 Matt Anodized

NANO-R14 RECESSED

OPAL DIFFUSER

		IP40	5 W/m	60 LED/m			
Color T.	W/m	c (mm)	Power (W)	Output (lm)	WHITE	Output (lm)	ANODIZED
2700 K	5	230	1	82	33.41.15.005917	70	33.41.15.005809
		330	1,5	123	33.41.15.005924	105	33.41.15.005816
		430	2	164	33.41.15.005931	140	33.41.15.005823
		530	3	205	33.41.15.005179	174	33.41.15.005053
		1030	5	410	33.41.15.005183	349	33.41.15.005057
		1530	8	616	33.41.15.005187	523	33.41.15.005061
		2030	10	821	33.41.15.005191	698	33.41.15.005065
		2530	13	1026	33.41.15.005195	872	33.41.15.005069
		3030	15	1231	33.41.15.005199	1047	33.41.15.005073
		3000 K	5	230	1	85	33.41.15.005938
330	1,5			127	33.41.15.005945	108	33.41.15.005837
430	2			169	33.41.15.005952	144	33.41.15.005844
530	3			212	33.41.15.005203	180	33.41.15.005077
1030	5			423	33.41.15.005207	360	33.41.15.005081
1530	8			635	33.41.15.005211	540	33.41.15.005085
2030	10			846	33.41.15.005215	719	33.41.15.005089
2530	13			1058	33.41.15.005219	899	33.41.15.005093
3030	15			1269	33.41.15.005223	1079	33.41.15.005097
4000 K	5			230	1	86	33.41.15.005959
		330	1,5	129	33.41.15.005966	110	33.41.15.005858
		430	2	173	33.41.15.005973	147	33.41.15.005865
		530	3	216	33.41.15.005227	183	33.41.15.005101
		1030	5	432	33.41.15.005231	367	33.41.15.005105
		1530	8	647	33.41.15.005235	550	33.41.15.005109
		2030	10	863	33.41.15.005239	734	33.41.15.005113
		2530	13	1079	33.41.15.005243	917	33.41.15.005117
		3030	15	1295	33.41.15.005247	1101	33.41.15.005121

— External Driver information on page 107.

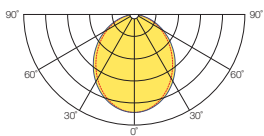

CUT OUT

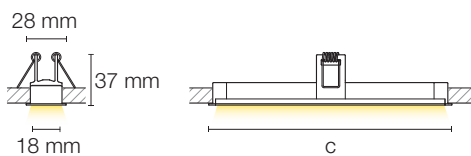
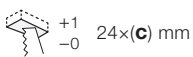

LIGHTING DETAIL



▲ 5 W/m | 60 LED/m



▲ 8, 12, 22 W/m | 120 LED/m

QUICK INFO

GENERAL

Recessed
IP40
IK06
850°C
Class III
Ta= -20°C +35°C

OPTIC

Opal Polycarbonate

LIGHT SOURCE

LED Flexible

SPECIFICATIONS

Efficacy up to 135 lm/W
2700 K, 3000 K, 4000 K
CRI >80
Lifetime 30 000 H
L80/B10 @Tc=55°C
24 VDC

ELECTRICAL SYSTEM

ON/OFF, DALI
External Drivers Info - page 107

FINISHING

RAL 9003 Matt White
Matt Anodized

NANO-R14 RECESSED

OPAL DIFFUSER

		IP40	8 W/m	120 LED/m					
Color T.	W/m	c (mm)	Power (W)	Output (lm)	WHITE	Output (lm)	ANODIZED		
2700 K	8	230	1,6	140	33.41.15.005918	119	33.41.15.005810		
		280	2	176	33.41.15.005921	149	33.41.15.005813		
		330	2,4	211	33.41.15.005925	179	33.41.15.005817		
		380	2,8	246	33.41.15.005928	209	33.41.15.005820		
		430	3,2	281	33.41.15.005932	239	33.41.15.005824		
		480	3,6	316	33.41.15.005935	269	33.41.15.005827		
		530	4	351	33.41.15.005180	299	33.41.15.005054		
		1030	8	702	33.41.15.005184	597	33.41.15.005058		
		1530	12	1053	33.41.15.005188	896	33.41.15.005062		
		2030	16	1405	33.41.15.005192	1194	33.41.15.005066		
		2530	20	1756	33.41.15.005196	1493	33.41.15.005070		
		3030	24	2107	33.41.15.005200	1791	33.41.15.005074		
		3000 K	8	230	1,6	144	33.41.15.005939	122	33.41.15.005831
				280	2	180	33.41.15.005942	153	33.41.15.005834
				330	2,4	216	33.41.15.005946	183	33.41.15.005838
380	2,8			252	33.41.15.005949	214	33.41.15.005841		
430	3,2			288	33.41.15.005953	245	33.41.15.005845		
480	3,6			324	33.41.15.005956	275	33.41.15.005848		
530	4			360	33.41.15.005204	306	33.41.15.005078		
1030	8			719	33.41.15.005208	611	33.41.15.005082		
1530	12			1079	33.41.15.005212	917	33.41.15.005086		
2030	16			1438	33.41.15.005216	1223	33.41.15.005090		
2530	20			1798	33.41.15.005220	1529	33.41.15.005094		
3030	24			2158	33.41.15.005224	1834	33.41.15.005098		
4000 K	8			230	1,6	151	33.41.15.005960	128	33.41.15.005852
				280	2	188	33.41.15.005963	160	33.41.15.005855
				330	2,4	226	33.41.15.005967	192	33.41.15.005859
		380	2,8	264	33.41.15.005970	224	33.41.15.005862		
		430	3,2	301	33.41.15.005974	256	33.41.15.005866		
		480	3,6	339	33.41.15.005977	288	33.41.15.005869		
		530	4	377	33.41.15.005228	320	33.41.15.005102		
		1030	8	753	33.41.15.005232	640	33.41.15.005106		
		1530	12	1130	33.41.15.005236	960	33.41.15.005110		
		2030	16	1506	33.41.15.005240	1280	33.41.15.005114		
		2530	20	1883	33.41.15.005244	1601	33.41.15.005118		
		3030	24	2259	33.41.15.005248	1921	33.41.15.005122		

— External Driver information on page 107.

CUT OUT

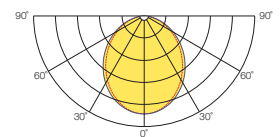
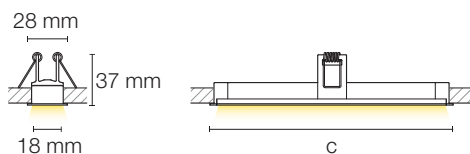
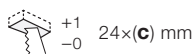

QUICK INFO

GENERAL

Recessed
IP40
IK06
850°C
Class III
Ta= -20°C +35°C

OPTIC

Opal Polycarbonate

LIGHT SOURCE

LED Flexible

SPECIFICATIONS

Efficacy up to 135 lm/W
2700 K, 3000 K, 4000 K
CRI >80
Lifetime 30 000 H
L80/B10 @Tc=55°C
24 VDC

ELECTRICAL SYSTEM

ON/OFF, DALI
External Drivers Info - page 107

FINISHING

RAL 9003 Matt White
Matt Anodized

NANO-R14 RECESSED

OPAL DIFFUSER

		IP40	12 W/m	120 LED/m			
Color T.	W/m	c (mm)	Power (W)	Output (lm)	WHITE	Output (lm)	ANODIZED
2700 K	12	230	2,4	186	33.41.15.005919	158	33.41.15.005811
		280	3	233	33.41.15.005922	198	33.41.15.005814
		330	3,6	279	33.41.15.005926	237	33.41.15.005818
		380	4,2	326	33.41.15.005929	277	33.41.15.005821
		430	4,8	372	33.41.15.005933	317	33.41.15.005825
		480	5,4	419	33.41.15.005936	356	33.41.15.005828
		530	6	465	33.41.15.005181	396	33.41.15.005055
		1030	12	931	33.41.15.005185	791	33.41.15.005059
		1530	18	1396	33.41.15.005189	1187	33.41.15.005063
		2030	24	1862	33.41.15.005193	1583	33.41.15.005067
		2530	30	2327	33.41.15.005197	1978	33.41.15.005071
		3030	36	2792	33.41.15.005201	2374	33.41.15.005075
3000 K	12	230	2,4	195	33.41.15.005940	165	33.41.15.005832
		280	3	243	33.41.15.005943	207	33.41.15.005835
		330	3,6	292	33.41.15.005947	248	33.41.15.005839
		380	4,2	341	33.41.15.005950	290	33.41.15.005842
		430	4,8	389	33.41.15.005954	331	33.41.15.005846
		480	5,4	438	33.41.15.005957	372	33.41.15.005849
		530	6	487	33.41.15.005205	414	33.41.15.005079
		1030	12	973	33.41.15.005209	827	33.41.15.005083
		1530	18	1460	33.41.15.005213	1241	33.41.15.005087
		2030	24	1946	33.41.15.005217	1655	33.41.15.005091
		2530	30	2433	33.41.15.005221	2068	33.41.15.005095
		3030	36	2919	33.41.15.005225	2482	33.41.15.005099
4000 K	12	230	2,4	203	33.41.15.005961	173	33.41.15.005853
		280	3	254	33.41.15.005964	216	33.41.15.005856
		330	3,6	305	33.41.15.005968	259	33.41.15.005860
		380	4,2	355	33.41.15.005971	302	33.41.15.005863
		430	4,8	406	33.41.15.005975	345	33.41.15.005867
		480	5,4	457	33.41.15.005978	388	33.41.15.005870
		530	6	508	33.41.15.005229	432	33.41.15.005103
		1030	12	1015	33.41.15.005233	863	33.41.15.005107
		1530	18	1523	33.41.15.005237	1295	33.41.15.005111
		2030	24	2031	33.41.15.005241	1726	33.41.15.005115
		2530	30	2539	33.41.15.005245	2158	33.41.15.005119
		3030	36	3046	33.41.15.005249	2590	33.41.15.005123

— External Driver information on page 107.

CUT OUT

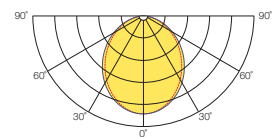
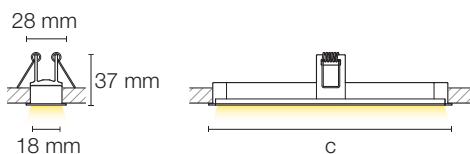
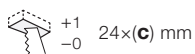

QUICK INFO

GENERAL

Recessed
 IP40
 IK06
 850°C
 Class III
 Ta= -20°C +35°C

OPTIC

Opal Polycarbonate

LIGHT SOURCE

LED Flexible

SPECIFICATIONS

Efficacy up to 135 lm/W
 2700 K, 3000 K, 4000 K
 CRI >80
 Lifetime 30 000 H
 L80/B10 @Tc=55°C
 24 VDC

ELECTRICAL SYSTEM

ON/OFF, DALI
 External Drivers Info - page 107

FINISHING

RAL 9003 Matt White
 Matt Anodized

NANO-R14 RECESSED

OPAL DIFFUSER

		IP40	22 W/m	120 LED/m					
Color T.	W/m	c (mm)	Power (W)	Output (lm)	WHITE	Output (lm)	ANODIZED		
2700 K	22	230	4,4	349	33.41.15.005920	296	33.41.15.005812		
		280	5,5	436	33.41.15.005923	370	33.41.15.005815		
		330	6,6	523	33.41.15.005927	445	33.41.15.005819		
		380	7,7	610	33.41.15.005930	519	33.41.15.005822		
		430	8,8	697	33.41.15.005934	593	33.41.15.005826		
		480	9,9	784	33.41.15.005937	667	33.41.15.005829		
		530	11	872	33.41.15.005182	741	33.41.15.005056		
		1030	22	1743	33.41.15.005186	1482	33.41.15.005060		
		1530	33	2615	33.41.15.005190	2223	33.41.15.005064		
		2030	44	3486	33.41.15.005194	2964	33.41.15.005068		
		2530	55	4358	33.41.15.005198	3705	33.41.15.005072		
		3030	66	5229	33.41.15.005202	4446	33.41.15.005076		
		3000 K	22	230	4,4	363	33.41.15.005941	309	33.41.15.005833
				280	5,5	454	33.41.15.005944	386	33.41.15.005836
				330	6,6	545	33.41.15.005948	463	33.41.15.005840
380	7,7			635	33.41.15.005951	540	33.41.15.005843		
430	8,8			726	33.41.15.005955	617	33.41.15.005847		
480	9,9			817	33.41.15.005958	694	33.41.15.005850		
530	11			908	33.41.15.005206	772	33.41.15.005080		
1030	22			1815	33.41.15.005210	1543	33.41.15.005084		
1530	33			2723	33.41.15.005214	2315	33.41.15.005088		
2030	44			3630	33.41.15.005218	3086	33.41.15.005092		
2530	55			4538	33.41.15.005222	3858	33.41.15.005096		
3030	66			5445	33.41.15.005226	4629	33.41.15.005100		
4000 K	22			230	4,4	372	33.41.15.005962	317	33.41.15.005854
				280	5,5	465	33.41.15.005965	396	33.41.15.005857
				330	6,6	558	33.41.15.005969	475	33.41.15.005861
		380	7,7	652	33.41.15.005972	554	33.41.15.005864		
		430	8,8	745	33.41.15.005976	633	33.41.15.005868		
		480	9,9	838	33.41.15.005979	712	33.41.15.005871		
		530	11	931	33.41.15.005230	791	33.41.15.005104		
		1030	22	1862	33.41.15.005234	1583	33.41.15.005108		
		1530	33	2792	33.41.15.005238	2374	33.41.15.005112		
		2030	44	3723	33.41.15.005242	3165	33.41.15.005116		
		2530	55	4654	33.41.15.005246	3956	33.41.15.005120		
		3030	66	5585	33.41.15.005250	4748	33.41.15.005124		

— External Driver information on page 107.

CUT OUT

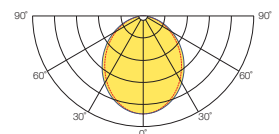
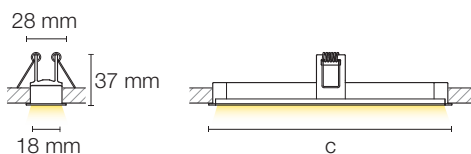
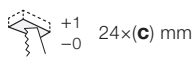

QUICK INFO

GENERAL

Recessed
 IP65
 IK06
 850°C
 Class III
 Ta= -20°C +35°C

OPTIC

Opal Polycarbonate

LIGHT SOURCE

LED Flexible

SPECIFICATIONS

Efficacy up to 135 lm/W
 2700 K, 3000 K, 4000 K
 CRI >80
 Lifetime 30 000 H
 L80/B10 @Tc=55°C
 24 VDC

ELECTRICAL SYSTEM

ON/OFF, DALI
 External Drivers Info - page 107

FINISHING

RAL 9003 Matt White
 Matt Anodized

NANO-R14 RECESSED

OPAL DIFFUSER

		IP65	5 W/m	60 LED/m			
Color T.	W/m	c (mm)	Power (W)	Output (lm)	WHITE	Output (lm)	ANODIZED
2700 K	5	235	1	77	33.41.15.005980	66	33.41.15.005872
		335	1,5	115	33.41.15.005985	99	33.41.15.005877
		435	2	154	33.41.15.005990	133	33.41.15.005882
		535	3	192	33.41.15.005251	166	33.41.15.005125
		1035	5	384	33.41.15.005254	332	33.41.15.005128
		1535	8	576	33.41.15.005257	497	33.41.15.005131
		2035	10	768	33.41.15.005260	663	33.41.15.005134
		2535	13	960	33.41.15.005263	829	33.41.15.005137
		3035	15	1152	33.41.15.005266	995	33.41.15.005140
		3000 K	5	235	1	79	33.41.15.005995
335	1,5			119	33.41.15.006000	103	33.41.15.005892
435	2			158	33.41.15.006005	137	33.41.15.005897
535	3			198	33.41.15.005269	171	33.41.15.005143
1035	5			396	33.41.15.005272	342	33.41.15.005146
1535	8			594	33.41.15.005275	513	33.41.15.005149
2035	10			792	33.41.15.005278	684	33.41.15.005152
2535	13			990	33.41.15.005281	855	33.41.15.005155
3035	15			1187	33.41.15.005284	1026	33.41.15.005158
4000 K	5			235	1	81	33.41.15.006010
		335	1,5	121	33.41.15.006015	105	33.41.15.005907
		435	2	161	33.41.15.006020	140	33.41.15.005912
		535	3	202	33.41.15.005287	174	33.41.15.005161
		1035	5	404	33.41.15.005290	349	33.41.15.005164
		1535	8	606	33.41.15.005293	523	33.41.15.005167
		2035	10	807	33.41.15.005296	698	33.41.15.005170
		2535	13	1009	33.41.15.005299	872	33.41.15.005173
		3035	15	1211	33.41.15.005302	1046	33.41.15.005176

— External Driver information on page 107.

CUT OUT

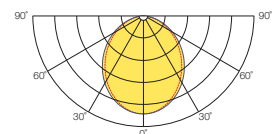
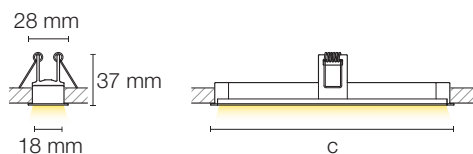
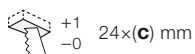

QUICK INFO

GENERAL

Recessed
 IP65
 IK06
 850°C
 Class III
 Ta= -20°C +35°C

OPTIC

Opal Polycarbonate

LIGHT SOURCE

LED Flexible

SPECIFICATIONS

Efficacy up to 135 lm/W
 2700 K, 3000 K, 4000 K
 CRI >80
 Lifetime 30 000 H
 L80/B10 @Tc=55°C
 24 VDC

ELECTRICAL SYSTEM

ON/OFF, DALI
 External Drivers Info - page 107

FINISHING

RAL 9003 Matt White
 Matt Anodized

NANO-R14 RECESSED

OPAL DIFFUSER

		IP65	8 W/m	120 LED/m					
Color T.	W/m	c (mm)	Power (W)	Output (lm)	WHITE	Output (lm)	ANODIZED		
2700 K	8	235	1,6	131	33.41.15.005981	114	33.41.15.005873		
		285	2	164	33.41.15.005983	142	33.41.15.005875		
		335	2,4	197	33.41.15.005986	170	33.41.15.005878		
		385	2,8	230	33.41.15.005988	199	33.41.15.005880		
		435	3,2	263	33.41.15.005991	227	33.41.15.005883		
		485	3,6	296	33.41.15.005993	255	33.41.15.005885		
		535	4	329	33.41.15.005252	284	33.41.15.005126		
		1035	8	657	33.41.15.005255	568	33.41.15.005129		
		1535	12	986	33.41.15.005258	851	33.41.15.005132		
		2035	16	1314	33.41.15.005261	1135	33.41.15.005135		
		2535	20	1643	33.41.15.005264	1419	33.41.15.005138		
		3035	24	1971	33.41.15.005267	1703	33.41.15.005141		
		3000 K	8	235	1,6	135	33.41.15.005996	116	33.41.15.005888
				285	2	168	33.41.15.005998	145	33.41.15.005890
				335	2,4	202	33.41.15.006001	174	33.41.15.005893
385	2,8			236	33.41.15.006003	203	33.41.15.005895		
435	3,2			269	33.41.15.006006	233	33.41.15.005898		
485	3,6			303	33.41.15.006008	262	33.41.15.005900		
535	4			336	33.41.15.005270	291	33.41.15.005144		
1035	8			673	33.41.15.005273	581	33.41.15.005147		
1535	12			1009	33.41.15.005276	872	33.41.15.005150		
2035	16			1346	33.41.15.005279	1163	33.41.15.005153		
2535	20			1682	33.41.15.005282	1453	33.41.15.005156		
3035	24			2019	33.41.15.005285	1744	33.41.15.005159		
4000 K	8			235	1,6	141	33.41.15.006011	122	33.41.15.005903
				285	2	176	33.41.15.006013	152	33.41.15.005905
				335	2,4	211	33.41.15.006016	183	33.41.15.005908
		385	2,8	247	33.41.15.006018	213	33.41.15.005910		
		435	3,2	282	33.41.15.006021	243	33.41.15.005913		
		485	3,6	317	33.41.15.006023	274	33.41.15.005915		
		535	4	352	33.41.15.005288	304	33.41.15.005162		
		1035	8	705	33.41.15.005291	609	33.41.15.005165		
		1535	12	1057	33.41.15.005294	913	33.41.15.005168		
		2035	16	1409	33.41.15.005297	1217	33.41.15.005171		
		2535	20	1761	33.41.15.005300	1522	33.41.15.005174		
		3035	24	2114	33.41.15.005303	1826	33.41.15.005177		

— External Driver information on page 107.

CUT OUT

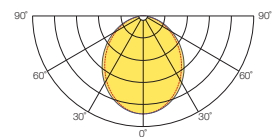
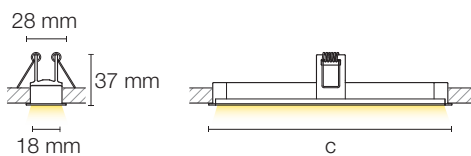
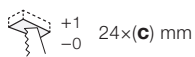

QUICK INFO

GENERAL

Recessed
 IP65
 IK06
 850°C
 Class III
 Ta= -20°C +35°C

OPTIC

Opal Polycarbonate

LIGHT SOURCE

LED Flexible

SPECIFICATIONS

Efficacy up to 135 lm/W
 2700 K, 3000 K, 4000 K
 CRI >80
 Lifetime 30 000 H
 L80/B10 @Tc=55°C
 24 VDC

ELECTRICAL SYSTEM

ON/OFF, DALI
 External Drivers Info - page 107

FINISHING

RAL 9003 Matt White
 Matt Anodized

NANO-R14 RECESSED

OPAL DIFFUSER

		IP65	12 W/m	120 LED/m					
Color T.	W/m	c (mm)	Power (W)	Output (lm)	WHITE	Output (lm)	ANODIZED		
2700 K	12	235	2,4	174	33.41.15.005982	150	33.41.15.005874		
		285	3	218	33.41.15.005984	188	33.41.15.005876		
		335	3,6	261	33.41.15.005987	226	33.41.15.005879		
		385	4,2	305	33.41.15.005989	263	33.41.15.005881		
		435	4,8	348	33.41.15.005992	301	33.41.15.005884		
		485	5,4	392	33.41.15.005994	338	33.41.15.005886		
		535	6	435	33.41.15.005253	376	33.41.15.005127		
		1035	12	871	33.41.15.005256	752	33.41.15.005130		
		1535	18	1306	33.41.15.005259	1128	33.41.15.005133		
		2035	24	1742	33.41.15.005262	1504	33.41.15.005136		
		2535	30	2177	33.41.15.005265	1881	33.41.15.005139		
		3035	36	2612	33.41.15.005268	2257	33.41.15.005142		
		3000 K	12	235	2,4	182	33.41.15.005997	157	33.41.15.005889
				285	3	228	33.41.15.005999	197	33.41.15.005891
				335	3,6	273	33.41.15.006002	236	33.41.15.005894
385	4,2			319	33.41.15.006004	275	33.41.15.005896		
435	4,8			364	33.41.15.006007	315	33.41.15.005899		
485	5,4			410	33.41.15.006009	354	33.41.15.005901		
535	6			455	33.41.15.005271	393	33.41.15.005145		
1035	12			910	33.41.15.005274	786	33.41.15.005148		
1535	18			1366	33.41.15.005277	1180	33.41.15.005151		
2035	24			1821	33.41.15.005280	1573	33.41.15.005154		
2535	30			2276	33.41.15.005283	1966	33.41.15.005157		
3035	36			2731	33.41.15.005286	2359	33.41.15.005160		
4000 K	12			235	2,4	190	33.41.15.006012	164	33.41.15.005904
				285	3	237	33.41.15.006014	205	33.41.15.005906
				335	3,6	285	33.41.15.006017	246	33.41.15.005909
		385	4,2	332	33.41.15.006019	287	33.41.15.005911		
		435	4,8	380	33.41.15.006022	328	33.41.15.005914		
		485	5,4	427	33.41.15.006024	369	33.41.15.005916		
		535	6	475	33.41.15.005289	410	33.41.15.005163		
		1035	12	950	33.41.15.005292	821	33.41.15.005166		
		1535	18	1425	33.41.15.005295	1231	33.41.15.005169		
		2035	24	1900	33.41.15.005298	1641	33.41.15.005172		
		2535	30	2375	33.41.15.005301	2051	33.41.15.005175		
		3035	36	2850	33.41.15.005304	2462	33.41.15.005178		

— External Driver information on page 107.

CUT OUT

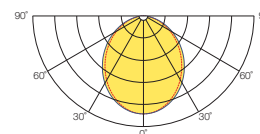
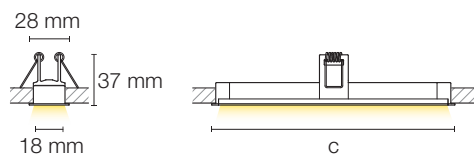
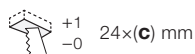

NANO-T14 IP40, IP65

TRIMLESS



PT

- Luminária LED em perfil de alumínio para aplicação encastrada sem aba de remate (trimless).
- Integração em tetos e paredes de gesso cartonado para um acabamento perfeito e um aspeto sofisticado.
- Perfil de alumínio compacto com uma largura muito reduzida.
- Disponível em versões IP65 para locais com humidade ou sujeitos a condensações.
- Driver externo de tensão constante e classe de proteção II.
- Difusor em Policarbonato Opal e corpo em perfil de alumínio.
- Em vários comprimentos, temperaturas de cor e potências de LED para se adequar às mais diversas aplicações.

EN

- Plaster-in trimless recessed mounted aluminium profile LED luminaire.
- Integration in plasterboard ceilings and walls for a clean, sophisticated look.
- Small aluminium profile with a very narrow width.
- An IP65 version is available for damp environments or places prone to condensation.
- External class II constant voltage Driver.
- Opal Polycarbonate diffuser and aluminium profile body.
- Available in several lengths, LED colour temperatures and powers to suit most applications.

QUICK INFO

GENERAL

Trimless
 IP40
 IK06
 850°C
 Class III
 Ta= -20°C +35°C

OPTIC

Opal Polycarbonate

LIGHT SOURCE

LED Flexible

SPECIFICATIONS

Efficacy up to 135 lm/W
 2700 K, 3000 K, 4000 K
 CRI >80
 Lifetime 30 000 H
 L80/B10 @Tc=55°C
 24 VDC

ELECTRICAL SYSTEM

ON/OFF, DALI
 External Drivers Info - page 107

FINISHING

RAL 9003 Matt White

NANO-T14 TRIMLESS

OPAL DIFFUSER

		IP40	5 W/m	60 LED/m		
Color Temp.	W/m	c (mm)	Power (W)	Output (lm)	WHITE	
2700 K	5	230	1	82	33.41.15.006241	
		330	1,5	123	33.41.15.006248	
		430	2	164	33.41.15.006255	
		530	3	205	33.41.15.005557	
		1030	5	410	33.41.15.005561	
		1530	8	616	33.41.15.005565	
		2030	10	821	33.41.15.005569	
3000 K	5	2530	13	1026	33.41.15.005573	
		3030	15	1231	33.41.15.005577	
		230	1	85	33.41.15.006262	
		330	1,5	127	33.41.15.006269	
		430	2	169	33.41.15.006276	
		530	3	212	33.41.15.005581	
		1030	5	423	33.41.15.005585	
4000 K	5	1530	8	635	33.41.15.005589	
		2030	10	846	33.41.15.005593	
		2530	13	1058	33.41.15.005597	
		3030	15	1269	33.41.15.005601	
		230	1	86	33.41.15.006283	
		330	1,5	129	33.41.15.006290	
		430	2	173	33.41.15.006297	
4000 K	5	530	3	216	33.41.15.005605	
		1030	5	432	33.41.15.005609	
		1530	8	647	33.41.15.005613	
		2030	10	863	33.41.15.005617	
		2530	13	1079	33.41.15.005621	
		3030	15	1295	33.41.15.005625	

— External Driver information on page 107.

OPTIONS

INSTALLATION COVER (1pc)

TYPE	COD
Trimless Installation Cover with 2050mm lenght	35.41.15.000970

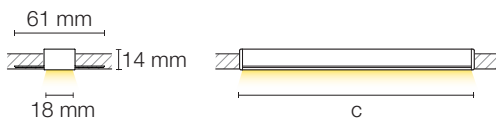
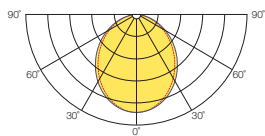

LIGHTING DETAIL



▲ 5 W/m | 60 LED/m



▲ 8, 12, 22 W/m | 120 LED/m

QUICK INFO

GENERAL

Trimless
IP40
IK06
850°C
Class III
Ta= -20°C +35°C

OPTIC

Opal Polycarbonate

LIGHT SOURCE

LED Flexible

SPECIFICATIONS

Efficacy up to 135 lm/W
2700 K, 3000 K, 4000 K
CRI >80
Lifetime 30 000 H
L80/B10 @Tc=55°C
24 VDC

ELECTRICAL SYSTEM

ON/OFF, DALI
External Drivers Info - page 107

FINISHING

RAL 9003 Matt White

NANO-T14 TRIMLESS

OPAL DIFFUSER

		IP40	8 W/m	120 LED/m		
Color Temp.	W/m	c (mm)	Power (W)	Output (lm)	WHITE	
2700 K	8	230	1,6	140	33.41.15.006242	
		280	2	176	33.41.15.006245	
		330	2,4	211	33.41.15.006249	
		380	2,8	246	33.41.15.006252	
		430	3,2	281	33.41.15.006256	
		480	3,6	316	33.41.15.006259	
		530	4	351	33.41.15.005558	
		1030	8	702	33.41.15.005562	
		1530	12	1053	33.41.15.005566	
		2030	16	1405	33.41.15.005570	
		2530	20	1756	33.41.15.005574	
		3030	24	2107	33.41.15.005578	
3000 K	8	230	1,6	144	33.41.15.006263	
		280	2	180	33.41.15.006266	
		330	2,4	216	33.41.15.006270	
		380	2,8	252	33.41.15.006273	
		430	3,2	288	33.41.15.006277	
		480	3,6	324	33.41.15.006280	
		530	4	360	33.41.15.005582	
		1030	8	719	33.41.15.005586	
		1530	12	1079	33.41.15.005590	
		2030	16	1438	33.41.15.005594	
		2530	20	1798	33.41.15.005598	
		3030	24	2158	33.41.15.005602	
4000 K	8	230	1,6	151	33.41.15.006284	
		280	2	188	33.41.15.006287	
		330	2,4	226	33.41.15.006291	
		380	2,8	264	33.41.15.006294	
		430	3,2	301	33.41.15.006298	
		480	3,6	339	33.41.15.006301	
		530	4	377	33.41.15.005606	
		1030	8	753	33.41.15.005610	
		1530	12	1130	33.41.15.005614	
		2030	16	1506	33.41.15.005618	
		2530	20	1883	33.41.15.005622	
		3030	24	2259	33.41.15.005626	

— External Driver information on page 107.

OPTIONS



INSTALLATION COVER (1pc)

TYPE

COD

Trimless Installation Cover with 2050mm lenght

35.41.15.000970

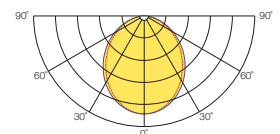
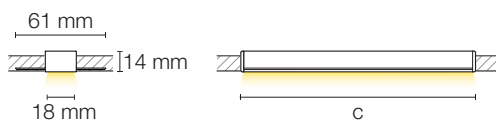

QUICK INFO

GENERAL

Trimless
 IP40
 IK06
 850°C
 Class III
 Ta= -20°C +35°C

OPTIC

Opal Polycarbonate

LIGHT SOURCE

LED Flexible

SPECIFICATIONS

Efficacy up to 135 lm/W
 2700 K, 3000 K, 4000 K
 CRI >80
 Lifetime 30 000 H
 L80/B10 @Tc=55°C
 24 VDC

ELECTRICAL SYSTEM

ON/OFF, DALI
 External Drivers Info - page 107

FINISHING

RAL 9003 Matt White

NANO-T14 TRIMLESS

OPAL DIFFUSER

		IP40	12 W/m	120 LED/m		
Color Temp.	W/m	c (mm)	Power (W)	Output (lm)	WHITE	
2700 K	12	230	2,4	186	33.41.15.006243	
		280	3	233	33.41.15.006246	
		330	3,6	279	33.41.15.006250	
		380	4,2	326	33.41.15.006253	
		430	4,8	372	33.41.15.006257	
		480	5,4	419	33.41.15.006260	
		530	6	465	33.41.15.005559	
		1030	12	931	33.41.15.005563	
		1530	18	1396	33.41.15.005567	
		2030	24	1862	33.41.15.005571	
		2530	30	2327	33.41.15.005575	
		3030	36	2792	33.41.15.005579	
3000 K	12	230	2,4	195	33.41.15.006264	
		280	3	243	33.41.15.006267	
		330	3,6	292	33.41.15.006271	
		380	4,2	341	33.41.15.006274	
		430	4,8	389	33.41.15.006278	
		480	5,4	438	33.41.15.006281	
		530	6	487	33.41.15.005583	
		1030	12	973	33.41.15.005587	
		1530	18	1460	33.41.15.005591	
		2030	24	1946	33.41.15.005595	
		2530	30	2433	33.41.15.005599	
		3030	36	2919	33.41.15.005603	
4000 K	12	230	2,4	203	33.41.15.006285	
		280	3	254	33.41.15.006288	
		330	3,6	305	33.41.15.006292	
		380	4,2	355	33.41.15.006295	
		430	4,8	406	33.41.15.006299	
		480	5,4	457	33.41.15.006302	
		530	6	508	33.41.15.005607	
		1030	12	1015	33.41.15.005611	
		1530	18	1523	33.41.15.005615	
		2030	24	2031	33.41.15.005619	
		2530	30	2539	33.41.15.005623	
		3030	36	3046	33.41.15.005627	

— External Driver information on page 107.

OPTIONS

INSTALLATION COVER (1pc)



TYPE	COD
Trimless Installation Cover with 2050mm lenght	35.41.15.000970

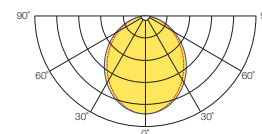
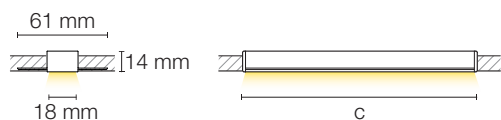

QUICK INFO

GENERAL

Trimless
IP40
IK06
850°C
Class III
Ta= -20°C +35°C

OPTIC

Opal Polycarbonate

LIGHT SOURCE

LED Flexible

SPECIFICATIONS

Efficacy up to 135 lm/W
2700 K, 3000 K, 4000 K
CRI >80
Lifetime 30 000 H
L80/B10 @Tc=55°C
24 VDC

ELECTRICAL SYSTEM

ON/OFF, DALI
External Drivers Info - page 107

FINISHING

RAL 9003 Matt White

NANO-T14 TRIMLESS

OPAL DIFFUSER

		IP40	22 W/m	120 LED/m		
Color Temp.	W/m	c (mm)	Power (W)	Output (lm)	WHITE	
2700 K	22	230	4,4	349	33.41.15.006244	
		280	5,5	436	33.41.15.006247	
		330	6,6	523	33.41.15.006251	
		380	7,7	610	33.41.15.006254	
		430	8,8	697	33.41.15.006258	
		480	9,9	784	33.41.15.006261	
		530	11	872	33.41.15.005560	
		1030	22	1743	33.41.15.005564	
		1530	33	2615	33.41.15.005568	
		2030	44	3486	33.41.15.005572	
		2530	55	4358	33.41.15.005576	
		3030	66	5229	33.41.15.005580	
3000 K	22	230	4,4	363	33.41.15.006265	
		280	5,5	454	33.41.15.006268	
		330	6,6	545	33.41.15.006272	
		380	7,7	635	33.41.15.006275	
		430	8,8	726	33.41.15.006279	
		480	9,9	817	33.41.15.006282	
		530	11	908	33.41.15.005584	
		1030	22	1815	33.41.15.005588	
		1530	33	2723	33.41.15.005592	
		2030	44	3630	33.41.15.005596	
		2530	55	4538	33.41.15.005600	
		3030	66	5445	33.41.15.005604	
4000 K	22	230	4,4	372	33.41.15.006286	
		280	5,5	465	33.41.15.006289	
		330	6,6	558	33.41.15.006293	
		380	7,7	652	33.41.15.006296	
		430	8,8	745	33.41.15.006300	
		480	9,9	838	33.41.15.006303	
		530	11	931	33.41.15.005608	
		1030	22	1862	33.41.15.005612	
		1530	33	2792	33.41.15.005616	
		2030	44	3723	33.41.15.005620	
		2530	55	4654	33.41.15.005624	
		3030	66	5585	33.41.15.005628	

— External Driver information on page 107.

OPTIONS



INSTALLATION COVER (1pc)

TYPE

COD

Trimless Installation Cover with 2050mm lenght

35.41.15.000970

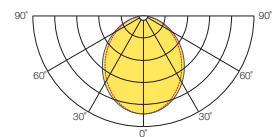
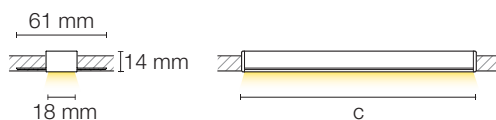

QUICK INFO

GENERAL

Trimless
 IP65
 IK06
 850°C
 Class III
 Ta= -20°C +35°C

OPTIC

Opal Polycarbonate

LIGHT SOURCE

LED Flexible

SPECIFICATIONS

Efficacy up to 135 lm/W
 2700 K, 3000 K, 4000 K
 CRI >80
 Lifetime 30 000 H
 L80/B10 @Tc=55°C
 24 VDC

ELECTRICAL SYSTEM

ON/OFF, DALI
 External Drivers Info - page 107

FINISHING

RAL 9003 Matt White

NANO-T14 TRIMLESS

OPAL DIFFUSER

		IP65	5 W/m	120 LED/m		
Color Temp.	W/m	c (mm)	Power (W)	Output (lm)	WHITE	
2700 K	5	235	1	77	33.41.15.006304	
		335	1,5	115	33.41.15.006309	
		435	2	154	33.41.15.006314	
		535	3	192	33.41.15.005629	
		1035	5	384	33.41.15.005632	
		1535	8	576	33.41.15.005635	
		2035	10	768	33.41.15.005638	
3000 K	5	2535	13	960	33.41.15.005641	
		3035	15	1152	33.41.15.005644	
		235	1	79	33.41.15.006319	
		335	1,5	119	33.41.15.006324	
		435	2	158	33.41.15.006329	
		535	3	198	33.41.15.005647	
		1035	5	396	33.41.15.005650	
4000 K	5	1535	8	594	33.41.15.005653	
		2035	10	792	33.41.15.005656	
		2535	13	990	33.41.15.005659	
		3035	15	1187	33.41.15.005662	
		235	1	81	33.41.15.006334	
		335	1,5	121	33.41.15.006339	
		435	2	161	33.41.15.006344	
4000 K	5	535	3	202	33.41.15.005665	
		1035	5	404	33.41.15.005668	
		1535	8	606	33.41.15.005671	
		2035	10	807	33.41.15.005674	
		2535	13	1009	33.41.15.005677	
		3035	15	1211	33.41.15.005680	

— External Driver information on page 107.

OPTIONS



INSTALLATION COVER (1pc)

TYPE	COD
Trimless Installation Cover with 2050mm lenght	35.41.15.000970

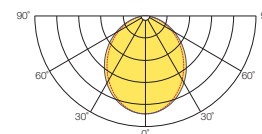
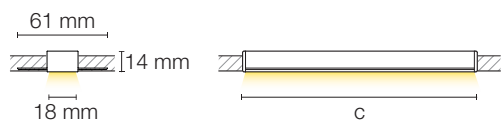

QUICK INFO

GENERAL

Trimless
IP65
IK06
850°C
Class III
Ta= -20°C +35°C

OPTIC

Opal Polycarbonate

LIGHT SOURCE

LED Flexible

SPECIFICATIONS

Efficacy up to 135 lm/W
2700 K, 3000 K, 4000 K
CRI >80
Lifetime 30 000 H
L80/B10 @Tc=55°C
24 VDC

ELECTRICAL SYSTEM

ON/OFF, DALI
External Drivers Info - page 107

FINISHING

RAL 9003 Matt White

NANO-T14 TRIMLESS

OPAL DIFFUSER

		IP65	8 W/m	120 LED/m		
Color Temp.	W/m	c (mm)	Power (W)	Output (lm)	WHITE	
2700 K	8	235	1,6	131	33.41.15.006305	
		285	2	164	33.41.15.006307	
		335	2,4	197	33.41.15.006310	
		385	2,8	230	33.41.15.006312	
		435	3,2	263	33.41.15.006315	
		485	3,6	296	33.41.15.006317	
		535	4	329	33.41.15.005630	
		1035	8	657	33.41.15.005633	
		1535	12	986	33.41.15.005636	
		2035	16	1314	33.41.15.005639	
		2535	20	1643	33.41.15.005642	
		3035	24	1971	33.41.15.005645	
3000 K	8	235	1,6	135	33.41.15.006320	
		285	2	168	33.41.15.006322	
		335	2,4	202	33.41.15.006325	
		385	2,8	236	33.41.15.006327	
		435	3,2	269	33.41.15.006330	
		485	3,6	303	33.41.15.006332	
		535	4	336	33.41.15.005648	
		1035	8	673	33.41.15.005651	
		1535	12	1009	33.41.15.005654	
		2035	16	1346	33.41.15.005657	
		2535	20	1682	33.41.15.005660	
		3035	24	2019	33.41.15.005663	
4000 K	8	235	1,6	141	33.41.15.006335	
		285	2	176	33.41.15.006337	
		335	2,4	211	33.41.15.006340	
		385	2,8	247	33.41.15.006342	
		435	3,2	282	33.41.15.006345	
		485	3,6	317	33.41.15.006347	
		535	4	352	33.41.15.005666	
		1035	8	705	33.41.15.005669	
		1535	12	1057	33.41.15.005672	
		2035	16	1409	33.41.15.005675	
		2535	20	1761	33.41.15.005678	
		3035	24	2114	33.41.15.005681	

— External Driver information on page 107.

OPTIONS



INSTALLATION COVER (1pc)

TYPE

COD

Trimless Installation Cover with 2050mm lenght

35.41.15.000970

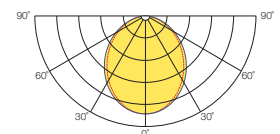
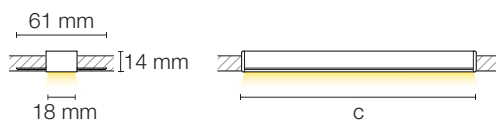

QUICK INFO

GENERAL

Trimless
IP65
IK06
850°C
Class III
Ta= -20°C +35°C

OPTIC

Opal Polycarbonate

LIGHT SOURCE

LED Flexible

SPECIFICATIONS

Efficacy up to 135 lm/W
2700 K, 3000 K, 4000 K
CRI >80
Lifetime 30 000 H
L80/B10 @Tc=55°C
24 VDC

ELECTRICAL SYSTEM

ON/OFF, DALI
External Drivers Info - page 107

FINISHING

RAL 9003 Matt White

NANO-T14 TRIMLESS

OPAL DIFFUSER

		IP65	12 W/m	120 LED/m		
Color Temp.	W/m	c (mm)	Power (W)	Output (lm)	WHITE	
2700 K	12	235	2,4	174	33.41.15.006306	
		285	3	218	33.41.15.006308	
		335	3,6	261	33.41.15.006311	
		385	4,2	305	33.41.15.006313	
		435	4,8	348	33.41.15.006316	
		485	5,4	392	33.41.15.006318	
		535	6	435	33.41.15.005631	
		1035	12	871	33.41.15.005634	
		1535	18	1306	33.41.15.005637	
		2035	24	1742	33.41.15.005640	
		2535	30	2177	33.41.15.005643	
		3035	36	2612	33.41.15.005646	
3000 K	12	235	2,4	182	33.41.15.006321	
		285	3	228	33.41.15.006323	
		335	3,6	273	33.41.15.006326	
		385	4,2	319	33.41.15.006328	
		435	4,8	364	33.41.15.006331	
		485	5,4	410	33.41.15.006333	
		535	6	455	33.41.15.005649	
		1035	12	910	33.41.15.005652	
		1535	18	1366	33.41.15.005655	
		2035	24	1821	33.41.15.005658	
		2535	30	2276	33.41.15.005661	
		3035	36	2731	33.41.15.005664	
4000 K	12	235	2,4	190	33.41.15.006336	
		285	3	237	33.41.15.006338	
		335	3,6	285	33.41.15.006341	
		385	4,2	332	33.41.15.006343	
		435	4,8	380	33.41.15.006346	
		485	5,4	427	33.41.15.006348	
		535	6	475	33.41.15.005667	
		1035	12	950	33.41.15.005670	
		1535	18	1425	33.41.15.005673	
		2035	24	1900	33.41.15.005676	
		2535	30	2375	33.41.15.005679	
		3035	36	2850	33.41.15.005682	

— External Driver information on page 107.

OPTIONS



INSTALLATION COVER (1pc)

TYPE

COD

Trimless Installation Cover with 2050mm lenght

35.41.15.000970

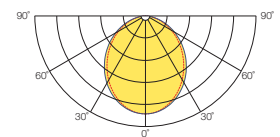
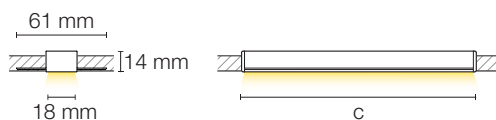

QUICK INFO

GENERAL

Trimless
IP65
IK06
850°C
Class III
Ta= -20°C +35°C

OPTIC

Opal Polycarbonate

LIGHT SOURCE

LED Flexible

SPECIFICATIONS

Efficacy up to 135 lm/W
2700 K, 3000 K, 4000 K
CRI >80
Lifetime 30 000 H
L80/B10 @Tc=55°C
24 VDC

ELECTRICAL SYSTEM

ON/OFF, DALI
External Drivers Info - page 107

FINISHING

RAL 9003 Matt White

NANO-T14 TRIMLESS

OPAL DIFFUSER

		IP65	22 W/m	120 LED/m				
Color Temp.	W/m	c (mm)	Power (W)	Output (lm)	WHITE			
2700 K	22	235	4,4	131	33.41.15.006793			
		285	5,5	164	33.41.15.006794			
		335	6,6	197	33.41.15.006795			
		385	7,7	230	33.41.15.006796			
		435	8,8	263	33.41.15.006797			
		485	9,9	296	33.41.15.006798			
		535	11	329	33.41.15.006799			
		1035	22	657	33.41.15.006800			
		1535	33	986	33.41.15.006801			
		2035	44	1314	33.41.15.006802			
		2535	55	1643	33.41.15.006803			
		3035	66	1971	33.41.15.006804			
		3000 K	22	235	4,4	135	33.41.15.006805	
				285	5,5	168	33.41.15.006806	
				335	6,6	202	33.41.15.006807	
385	7,7			236	33.41.15.006808			
435	8,8			269	33.41.15.006809			
485	9,9			303	33.41.15.006810			
535	11			336	33.41.15.006811			
1035	22			673	33.41.15.006812			
1535	33			1009	33.41.15.006813			
2035	44			1346	33.41.15.006814			
2535	55			1682	33.41.15.006815			
3035	66			2019	33.41.15.006816			
4000 K	22			235	4,4	141	33.41.15.006817	
				285	5,5	176	33.41.15.006818	
				335	6,6	211	33.41.15.006819	
		385	7,7	247	33.41.15.006820			
		435	8,8	282	33.41.15.006821			
		485	9,9	317	33.41.15.006822			
		535	11	352	33.41.15.006823			
		1035	22	705	33.41.15.006824			
		1535	33	1057	33.41.15.006825			
		2035	44	1409	33.41.15.006826			
		2535	55	1761	33.41.15.006827			
		3035	66	2114	33.41.15.006828			

— External Driver information on page 107.

OPTIONS



INSTALLATION COVER (1pc)

TYPE

COD

Trimless Installation Cover with 2050mm lenght

35.41.15.000970

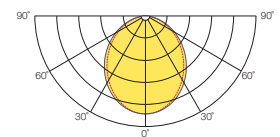
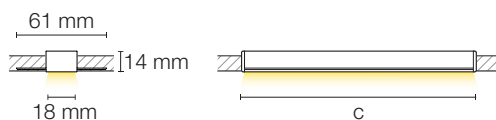



NANO EDGE IP40, IP65 TRIMLESS



PT

- Luminária LED em perfil de alumínio para aplicação encastrada sem aba de remate (trimless) no perímetro dos tetos falsos.
- Este wallwasher de perímetro é ideal para iluminação de realce em corredores ou iluminar arte e outros elementos na parede adjacente.
- Integração em tetos falsos de gesso cartonado para um acabamento perfeito e um aspeto sofisticado.
- Disponível em versões IP65 para locais com humidade ou sujeitos a condensações.
- Driver externo de tensão constante e classe de proteção II.
- Difusor em Policarbonato Opal e corpo em perfil de alumínio.
- Em vários comprimentos, temperaturas de cor e potências de LED para se adequar às mais diversas aplicações.

EN

- Aluminium profile LED luminaire for plaster-in trimless recessed mounting in the perimeter of false ceilings.
- This perimeter wallwasher is ideal for hallway accent lighting or for lighting art and other elements on the adjacent wall.
- Integration in plasterboard false ceilings for a clean, sophisticated look.
- An IP65 version is available for damp environments or places prone to condensation.
- External class II constant voltage Driver.
- Opal Polycarbonate diffuser and aluminium profile body.
- Available in several lengths, LED colour temperatures and powers to suit most applications.

QUICK INFO

GENERAL

Trimless
 IP40
 IK06
 850°C
 Class III
 Ta= -20°C +35°C

OPTIC

Opal Polycarbonate

LIGHT SOURCE

LED Flexible

SPECIFICATIONS

Efficacy up to 135 lm/W
 2700 K, 3000 K, 4000 K
 CRI >80
 Lifetime 30 000 H
 L80/B10 @Tc=55°C
 24 VDC

ELECTRICAL SYSTEM

ON/OFF, DALI
 External Drivers Info - page 107

FINISHING

RAL 9003 Matt White

NANO EDGE TRIMLESS

OPAL DIFFUSER

		IP40	5 W/m	60 LED/m		
Color Temp.	W/m	c (mm)	Power (W)	Output (lm)	WHITE	
2700 K	5	230	1	70	33.41.15.006349	
		330	1,5	105	33.41.15.006356	
		430	2	139	33.41.15.006363	
		530	3	174	33.41.15.005683	
		1030	5	349	33.41.15.005687	
		1530	8	523	33.41.15.005691	
		2030	10	697	33.41.15.005695	
		2530	13	871	33.41.15.005699	
3000 K	5	3030	15	1046	33.41.15.005703	
		230	1	72	33.41.15.006370	
		330	1,5	108	33.41.15.006377	
		430	2	144	33.41.15.006384	
		530	3	180	33.41.15.005707	
		1030	5	359	33.41.15.005711	
		1530	8	539	33.41.15.005715	
		2030	10	719	33.41.15.005719	
4000 K	5	2530	13	898	33.41.15.005723	
		3030	15	1078	33.41.15.005727	
		230	1	73	33.41.15.006391	
		330	1,5	110	33.41.15.006398	
		430	2	147	33.41.15.006405	
		530	3	183	33.41.15.005731	
		1030	5	367	33.41.15.005735	
		1530	8	550	33.41.15.005739	
		2030	10	733	33.41.15.005743	
		2530	13	916	33.41.15.005747	
		3030	15	1100	33.41.15.005751	

— External Driver information on page 107.

OPTIONS

INSTALLATION COVER (1pc)

TYPE	COD
Trimless Installation Cover with 2050mm lenght	35.41.15.000970

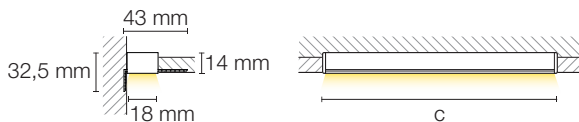
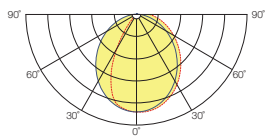

LIGHTING DETAIL



▲ 5 W/m | 60 LED/m



▲ 8, 12, 22 W/m | 120 LED/m

QUICK INFO

GENERAL

Trimless
 IP40
 IK06
 850°C
 Class III
 Ta= -20°C +35°C

OPTIC

Opal Polycarbonate

LIGHT SOURCE

LED Flexible

SPECIFICATIONS

Efficacy up to 135 lm/W
 2700 K, 3000 K, 4000 K
 CRI >80
 Lifetime 30 000 H
 L80/B10 @Tc=55°C
 24 VDC

ELECTRICAL SYSTEM

ON/OFF, DALI
 External Drivers Info - page 107

FINISHING

RAL 9003 Matt White

NANO EDGE TRIMLESS

OPAL DIFFUSER

		IP40	8 W/m	120 LED/m		
Color Temp.	W/m	c (mm)	Power (W)	Output (lm)	WHITE	
2700 K	8	230	1,6	119	33.41.15.006350	
		280	2	149	33.41.15.006353	
		330	2,4	179	33.41.15.006357	
		380	2,8	209	33.41.15.006360	
		430	3,2	239	33.41.15.006364	
		480	3,6	268	33.41.15.006367	
		530	4	298	33.41.15.005684	
		1030	8	597	33.41.15.005688	
		1530	12	895	33.41.15.005692	
		2030	16	1193	33.41.15.005696	
		2530	20	1491	33.41.15.005700	
		3030	24	1790	33.41.15.005704	
3000 K	8	230	1,6	122	33.41.15.006371	
		280	2	153	33.41.15.006374	
		330	2,4	183	33.41.15.006378	
		380	2,8	214	33.41.15.006381	
		430	3,2	244	33.41.15.006385	
		480	3,6	275	33.41.15.006388	
		530	4	305	33.41.15.005708	
		1030	8	611	33.41.15.005712	
		1530	12	916	33.41.15.005716	
		2030	16	1222	33.41.15.005720	
		2530	20	1527	33.41.15.005724	
		3030	24	1833	33.41.15.005728	
4000 K	8	230	1,6	128	33.41.15.006392	
		280	2	160	33.41.15.006395	
		330	2,4	192	33.41.15.006399	
		380	2,8	224	33.41.15.006402	
		430	3,2	256	33.41.15.006406	
		480	3,6	288	33.41.15.006409	
		530	4	320	33.41.15.005732	
		1030	8	640	33.41.15.005736	
		1530	12	959	33.41.15.005740	
		2030	16	1279	33.41.15.005744	
		2530	20	1599	33.41.15.005748	
		3030	24	1919	33.41.15.005752	

— External Driver information on page 107.

OPTIONS

INSTALLATION COVER (1pc)



TYPE

Trimless Installation Cover with 2050mm lenght

COD

35.41.15.000970

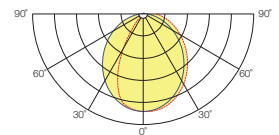
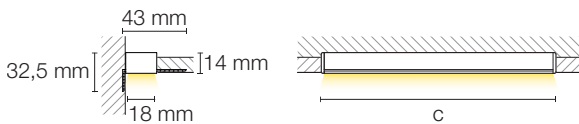

QUICK INFO

GENERAL

Trimless
 IP40
 IK06
 850°C
 Class III
 Ta= -20°C +35°C

OPTIC

Opal Polycarbonate

LIGHT SOURCE

LED Flexible

SPECIFICATIONS

Efficacy up to 135 lm/W
 2700 K, 3000 K, 4000 K
 CRI >80
 Lifetime 30 000 H
 L80/B10 @Tc=55°C
 24 VDC

ELECTRICAL SYSTEM

ON/OFF, DALI
 External Drivers Info - page 107

FINISHING

RAL 9003 Matt White

NANO EDGE TRIMLESS

OPAL DIFFUSER

		IP40	12 W/m	120 LED/m		
Color Temp.	W/m	c (mm)	Power (W)	Output (lm)	WHITE	
2700 K	12	230	2,4	158	33.41.15.006351	
		280	3	198	33.41.15.006354	
		330	3,6	237	33.41.15.006358	
		380	4,2	277	33.41.15.006361	
		430	4,8	316	33.41.15.006365	
		480	5,4	356	33.41.15.006368	
		530	6	395	33.41.15.005685	
		1030	12	791	33.41.15.005689	
		1530	18	1186	33.41.15.005693	
		2030	24	1581	33.41.15.005697	
		2530	30	1976	33.41.15.005701	
		3030	36	2372	33.41.15.005705	
3000 K	12	230	2,4	165	33.41.15.006372	
		280	3	207	33.41.15.006375	
		330	3,6	248	33.41.15.006379	
		380	4,2	289	33.41.15.006382	
		430	4,8	331	33.41.15.006386	
		480	5,4	372	33.41.15.006389	
		530	6	413	33.41.15.005709	
		1030	12	826	33.41.15.005713	
		1530	18	1240	33.41.15.005717	
		2030	24	1653	33.41.15.005721	
		2530	30	2066	33.41.15.005725	
		3030	36	2479	33.41.15.005729	
4000 K	12	230	2,4	172	33.41.15.006393	
		280	3	216	33.41.15.006396	
		330	3,6	259	33.41.15.006400	
		380	4,2	302	33.41.15.006403	
		430	4,8	345	33.41.15.006407	
		480	5,4	388	33.41.15.006410	
		530	6	431	33.41.15.005733	
		1030	12	862	33.41.15.005737	
		1530	18	1294	33.41.15.005741	
		2030	24	1725	33.41.15.005745	
		2530	30	2156	33.41.15.005749	
		3030	36	2587	33.41.15.005753	

— External Driver information on page 107.

OPTIONS

INSTALLATION COVER (1pc)



TYPE	COD
Trimless Installation Cover with 2050mm lenght	35.41.15.000970

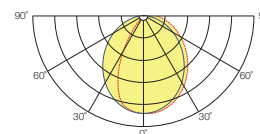
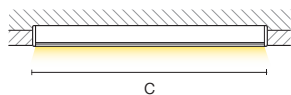
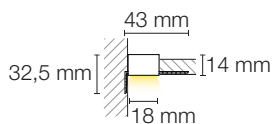

QUICK INFO

GENERAL

Trimless
IP40
IK06
850°C
Class III
Ta= -20°C +35°C

OPTIC

Opal Polycarbonate

LIGHT SOURCE

LED Flexible

SPECIFICATIONS

Efficacy up to 135 lm/W
2700 K, 3000 K, 4000 K
CRI >80
Lifetime 30 000 H
L80/B10 @Tc=55°C
24 VDC

ELECTRICAL SYSTEM

ON/OFF, DALI
External Drivers Info - page 107

FINISHING

RAL 9003 Matt White

NANO EDGE TRIMLESS

OPAL DIFFUSER

	IP40	22 W/m	120 LED/m		
Color Temp.	W/m	c (mm)	Power (W)	Output (lm)	WHITE
2700 K	22	230	4,4	296	33.41.15.006352
		280	5,5	370	33.41.15.006355
		330	6,6	444	33.41.15.006359
		380	7,7	518	33.41.15.006362
		430	8,8	592	33.41.15.006366
		480	9,9	666	33.41.15.006369
		530	11	740	33.41.15.005686
		1030	22	1480	33.41.15.005690
		1530	33	2221	33.41.15.005694
		2030	44	2961	33.41.15.005698
		2530	55	3701	33.41.15.005702
		3030	66	4441	33.41.15.005706
3000 K	22	230	4,4	308	33.41.15.006373
		280	5,5	385	33.41.15.006376
		330	6,6	462	33.41.15.006380
		380	7,7	540	33.41.15.006383
		430	8,8	617	33.41.15.006387
		480	9,9	694	33.41.15.006390
		530	11	771	33.41.15.005710
		1030	22	1542	33.41.15.005714
		1530	33	2312	33.41.15.005718
		2030	44	3083	33.41.15.005722
		2530	55	3854	33.41.15.005726
		3030	66	4625	33.41.15.005730
4000 K	22	230	4,4	316	33.41.15.006394
		280	5,5	395	33.41.15.006397
		330	6,6	474	33.41.15.006401
		380	7,7	553	33.41.15.006404
		430	8,8	632	33.41.15.006408
		480	9,9	711	33.41.15.006411
		530	11	791	33.41.15.005734
		1030	22	1581	33.41.15.005738
		1530	33	2372	33.41.15.005742
		2030	44	3162	33.41.15.005746
		2530	55	3953	33.41.15.005750
		3030	66	4743	33.41.15.005754

— External Driver information on page 107.

OPTIONS



INSTALLATION COVER (1pc)

TYPE

COD

Trimless Installation Cover with 2050mm lenght

35.41.15.000970

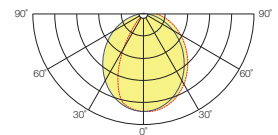
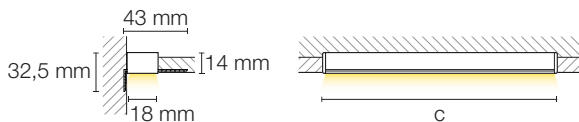

QUICK INFO

GENERAL

Trimless
 IP65
 IK06
 850°C
 Class III
 Ta= -20°C +35°C

OPTIC

Opal Polycarbonate

LIGHT SOURCE

LED Flexible

SPECIFICATIONS

Efficacy up to 135 lm/W
 2700 K, 3000 K, 4000 K
 CRI >80
 Lifetime 30 000 H
 L80/B10 @Tc=55°C
 24 VDC

ELECTRICAL SYSTEM

ON/OFF, DALI
 External Drivers Info - page 107

FINISHING

RAL 9003 Matt White

NANO EDGE TRIMLESS

OPAL DIFFUSER

		IP65	5 W/m	60 LED/m		
Color Temp.	W/m	c (mm)	Power (W)	Output (lm)	WHITE	
2700 K	5	235	1	66	33.41.15.006412	
		335	1,5	99	33.41.15.006417	
		435	2	132	33.41.15.006422	
		535	3	165	33.41.15.005755	
		1035	5	331	33.41.15.005758	
		1535	8	496	33.41.15.005761	
		2035	10	661	33.41.15.005764	
		2535	13	826	33.41.15.005767	
		3035	15	992	33.41.15.005770	
		3000 K	5	235	1	68
335	1,5			102	33.41.15.006432	
435	2			136	33.41.15.006437	
535	3			170	33.41.15.005773	
1035	5			341	33.41.15.005776	
1535	8			511	33.41.15.005779	
2035	10			682	33.41.15.005782	
2535	13			852	33.41.15.005785	
3035	15			1022	33.41.15.005788	
4000 K	5			235	1	70
		335	1,5	104	33.41.15.006447	
		435	2	139	33.41.15.006452	
		535	3	174	33.41.15.005791	
		1035	5	348	33.41.15.005794	
		1535	8	521	33.41.15.005797	
		2035	10	695	33.41.15.005800	
		2535	13	869	33.41.15.005803	
		3035	15	1043	33.41.15.005806	

— External Driver information on page 107.

OPTIONS



INSTALLATION COVER (1pc)

TYPE	COD
Trimless Installation Cover with 2050mm lenght	35.41.15.000970

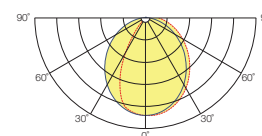
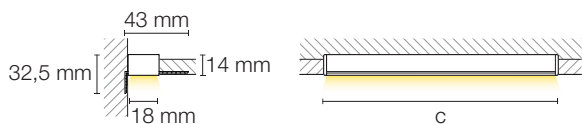

QUICK INFO

GENERAL

Trimless
IP65
IK06
850°C
Class III
Ta= -20°C +35°C

OPTIC

Opal Polycarbonate

LIGHT SOURCE

LED Flexible

SPECIFICATIONS

Efficacy up to 135 lm/W
2700 K, 3000 K, 4000 K
CRI >80
Lifetime 30 000 H
L80/B10 @Tc=55°C
24 VDC

ELECTRICAL SYSTEM

ON/OFF, DALI
External Drivers Info - page 107

FINISHING

RAL 9003 Matt White

NANO EDGE TRIMLESS

OPAL DIFFUSER

		IP65	8 W/m	120 LED/m		
Color Temp.	W/m	c (mm)	Power (W)	Output (lm)	WHITE	
2700 K	8	235	1,6	113	33.41.15.006413	
		285	2	141	33.41.15.006415	
		335	2,4	170	33.41.15.006418	
		385	2,8	198	33.41.15.006420	
		435	3,2	226	33.41.15.006423	
		485	3,6	255	33.41.15.006425	
		535	4	283	33.41.15.005756	
		1035	8	566	33.41.15.005759	
		1535	12	849	33.41.15.005762	
		2035	16	1131	33.41.15.005765	
		2535	20	1414	33.41.15.005768	
		3035	24	1697	33.41.15.005771	
3000 K	8	235	1,6	116	33.41.15.006428	
		285	2	145	33.41.15.006430	
		335	2,4	174	33.41.15.006433	
		385	2,8	203	33.41.15.006435	
		435	3,2	232	33.41.15.006438	
		485	3,6	261	33.41.15.006440	
		535	4	290	33.41.15.005774	
		1035	8	579	33.41.15.005777	
		1535	12	869	33.41.15.005780	
		2035	16	1159	33.41.15.005783	
		2535	20	1448	33.41.15.005786	
		3035	24	1738	33.41.15.005789	
4000 K	8	235	1,6	121	33.41.15.006443	
		285	2	152	33.41.15.006445	
		335	2,4	182	33.41.15.006448	
		385	2,8	212	33.41.15.006450	
		435	3,2	243	33.41.15.006453	
		485	3,6	273	33.41.15.006455	
		535	4	303	33.41.15.005792	
		1035	8	607	33.41.15.005795	
		1535	12	910	33.41.15.005798	
		2035	16	1213	33.41.15.005801	
		2535	20	1517	33.41.15.005804	
		3035	24	1820	33.41.15.005807	

— External Driver information on page 107.

OPTIONS



INSTALLATION COVER (1pc)

TYPE

COD

Trimless Installation Cover with 2050mm lenght

35.41.15.000970

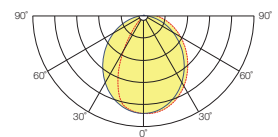
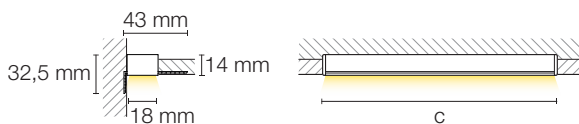

QUICK INFO

GENERAL

Trimless
 IP65
 IK06
 850°C
 Class III
 Ta= -20°C +35°C

OPTIC

Opal Polycarbonate

LIGHT SOURCE

LED Flexible

SPECIFICATIONS

Efficacy up to 135 lm/W
 2700 K, 3000 K, 4000 K
 CRI >80
 Lifetime 30 000 H
 L80/B10 @Tc=55°C
 24 VDC

ELECTRICAL SYSTEM

ON/OFF, DALI
 External Drivers Info - page 107

FINISHING

RAL 9003 Matt White

NANO EDGE TRIMLESS

OPAL DIFFUSER

		IP65	12 W/m	120 LED/m		
Color Temp.	W/m	c (mm)	Power (W)	Output (lm)	WHITE	
2700 K	12	235	2,4	150	33.41.15.006414	
		285	3	187	33.41.15.006416	
		335	3,6	225	33.41.15.006419	
		385	4,2	262	33.41.15.006421	
		435	4,8	300	33.41.15.006424	
		485	5,4	337	33.41.15.006426	
		535	6	375	33.41.15.005757	
		1035	12	750	33.41.15.005760	
		1535	18	1125	33.41.15.005763	
		2035	24	1500	33.41.15.005766	
		2535	30	1874	33.41.15.005769	
		3035	36	2249	33.41.15.005772	
3000 K	12	235	2,4	157	33.41.15.006429	
		285	3	196	33.41.15.006431	
		335	3,6	235	33.41.15.006434	
		385	4,2	274	33.41.15.006436	
		435	4,8	314	33.41.15.006439	
		485	5,4	353	33.41.15.006441	
		535	6	392	33.41.15.005775	
		1035	12	784	33.41.15.005778	
		1535	18	1176	33.41.15.005781	
		2035	24	1568	33.41.15.005784	
		2535	30	1960	33.41.15.005787	
		3035	36	2352	33.41.15.005790	
4000 K	12	235	2,4	164	33.41.15.006444	
		285	3	204	33.41.15.006446	
		335	3,6	245	33.41.15.006449	
		385	4,2	286	33.41.15.006451	
		435	4,8	327	33.41.15.006454	
		485	5,4	368	33.41.15.006456	
		535	6	409	33.41.15.005793	
		1035	12	818	33.41.15.005796	
		1535	18	1227	33.41.15.005799	
		2035	24	1636	33.41.15.005802	
		2535	30	2045	33.41.15.005805	
		3035	36	2454	33.41.15.005808	

— External Driver information on page 107.

OPTIONS

INSTALLATION COVER (1pc)



TYPE

Trimless Installation Cover with 2050mm lenght

COD

35.41.15.000970

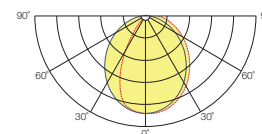
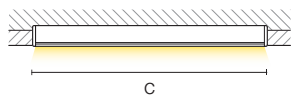
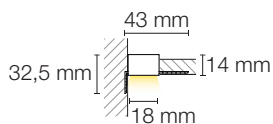

QUICK INFO

GENERAL

Trimless
IP65
IK06
850°C
Class III
Ta= -20°C +35°C

OPTIC

Opal Polycarbonate

LIGHT SOURCE

LED Flexible

SPECIFICATIONS

Efficacy up to 135 lm/W
2700 K, 3000 K, 4000 K
CRI >80
Lifetime 30 000 H
L80/B10 @Tc=55°C
24 VDC

ELECTRICAL SYSTEM

ON/OFF, DALI
External Drivers Info - page 107

FINISHING

RAL 9003 Matt White

NANO EDGE TRIMLESS

OPAL DIFFUSER

		IP65	22 W/m	120 LED/m		
Color Temp.	W/m	c (mm)	Power (W)	Output (lm)	WHITE	
2700 K	22	235	4,4	281	33.41.15.006829	
		285	5,5	351	33.41.15.006830	
		335	6,6	421	33.41.15.006831	
		385	7,7	491	33.41.15.006832	
		435	8,8	562	33.41.15.006833	
		485	9,9	632	33.41.15.006834	
		535	11	702	33.41.15.006835	
		1035	22	1404	33.41.15.006836	
		1535	33	2106	33.41.15.006837	
		2035	44	2808	33.41.15.006838	
		2535	55	3510	33.41.15.006839	
		3035	66	4212	33.41.15.006840	
3000 K	22	235	4,4	292	33.41.15.006841	
		285	5,5	366	33.41.15.006842	
		335	6,6	439	33.41.15.006843	
		385	7,7	366	33.41.15.006844	
		435	8,8	585	33.41.15.006845	
		485	9,9	658	33.41.15.006846	
		535	11	731	33.41.15.006847	
		1035	22	1462	33.41.15.006848	
		1535	33	2193	33.41.15.006849	
		2035	44	2924	33.41.15.006850	
		2535	55	3655	33.41.15.006851	
		3035	66	4386	33.41.15.006852	
4000 K	22	235	4,4	300	33.41.15.006853	
		285	5,5	375	33.41.15.006854	
		335	6,6	450	33.41.15.006855	
		385	7,7	525	33.41.15.006856	
		435	8,8	600	33.41.15.006857	
		485	9,9	675	33.41.15.006858	
		535	11	750	33.41.15.006859	
		1035	22	1500	33.41.15.006860	
		1535	33	2249	33.41.15.006861	
		2035	44	2999	33.41.15.006862	
		2535	55	3749	33.41.15.006863	
		3035	66	4499	33.41.15.006864	

— External Driver information on page 107.

OPTIONS



INSTALLATION COVER (1pc)

TYPE

COD

Trimless Installation Cover with 2050mm lenght

35.41.15.000970

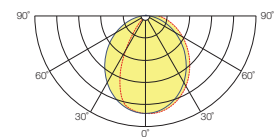
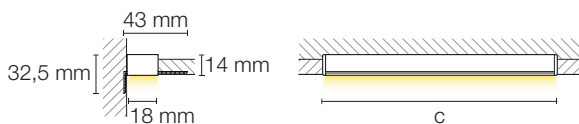

NANO IP40, IP65 DRIVERS & EMERGENCY

COMPONENTS

DRIVER - EXTERNAL



CLASS II

IP20

ON/OFF	DIMENSION	COD
Power Supply 30W IP20	26,5×40×145 mm	35.41.00.000117
Power Supply 60W IP20	31×40×200 mm	35.00.004.01.89
Power Supply 120W IP20	31×40×260 mm	35.41.00.000118
DALI	DIMENSION	COD
Power Supply 35W IP20	30,2×43×195 mm	35.00.004.01.92
Power Supply 60W IP20	30,2×43×225 mm	35.00.004.01.93
Power Supply 100W IP20	29,8×43×295 mm	35.00.004.01.94
Power Supply 150W IP20	29,8×43×325 mm	35.00.004.01.95

– External Driver to be housed nearby.



CLASS II

IP66

ON/OFF	DIMENSION	COD
Power Supply 20W IP66	25×43×178 mm	35.41.00.000119
Power Supply 40W IP66	26×43×208 mm	35.41.00.000120
Power Supply 60W IP66	26×43×208 mm	35.41.00.000121
Power Supply 100W IP66	34×50×240 mm	35.41.00.000122
Power Supply 130W IP66	37×63×220 mm	35.41.00.000123
DALI	DIMENSION	COD
Power Supply 100W IP66	37×69×237 mm	35.41.00.000124
Power Supply 210W IP66	37×69×330 mm	35.41.00.000125

– External Driver to be housed nearby.

OPTIONS



CLASS II

EMERGENCY (EM)

ON/OFF	REST MODE	COD
EM 1H MAX 30W	9 Vdc	35.00.005.01.36
EM 3H MAX 30W	9 Vdc	35.00.005.01.37



TUBULAR

TUPOLI 70 IP40
SUSPENDED



TUPOLI 70 IP40
SURFACE



TUPOLI IP40 SUSPENDED



PT

- Luminária tubular para aplicações de iluminação geral em interiores.
- Aplicação suspensa por cabos de aço inox com ajuste rápido da altura.
- Difusor cilíndrico em policarbonato transparente resistente ao impacto.
- Refletor interno para maior desempenho da luminária.
- Topos em alumínio com acabamento branco mate.
- Disponível em quatro comprimentos para funcionamento com tubos LED T8 (não incluídos).

EN

- Tubular luminaire suitable for general interior lighting.
- Suspended luminaire with stainless steel suspension with integrated tool-less height adjustment.
- Clear impact-resistant polycarbonate cylindrical diffuser.
- Inner reflector to increase the luminaire performance.
- Matt white powder coated aluminium end caps.
- Available in four lengths for use with T8 LED tubes (not included).

QUICK INFO

GENERAL

Suspended
 IP40
 IK06
 850°C
 Class I
 Ta= -20°C +35°C

OPTIC

Clear Polycarbonate

LIGHT SOURCE

LED Tubes (T8 G13)

ELECTRICAL SYSTEM

220-240V/50-60Hz
 ON/OFF

FINISHING

RAL 9003 Matt White

**TUPOLI SUSPENDED
 CLEAR DIFFUSER**

IP40

c (mm)	Tubes	Power (W)	Output (lm)	Scheme A	Scheme C
683	1	1x10 MAX	976 ⁽¹⁾	33.49.000.01.14	33.49.000.01.34
988	1	1x14 MAX	1463 ⁽²⁾	33.49.000.01.04	33.49.000.01.35
1293	1	1x22 MAX	2323 ⁽³⁾	33.49.000.01.05	33.49.000.01.36
1598	1	1x24 MAX	3438 ⁽⁴⁾	33.49.000.01.06	33.49.000.01.37

COMPONENTS



SUSPENSION SYSTEM (2pcs)

TYPE	1m	3m	5m
Matt White + Stainless Steel Cable	35.49.003.01.48	35.49.003.01.49	35.49.002.08.76



SURFACE CEILING CUP (1pc)

TYPE	1m	3m	5m
Matt White Ø62x36 mm	35.49.001.08.30	35.49.002.08.59	35.49.002.08.67



RECESSED CEILING CUP (1pc)

TYPE	1m	3m	5m
Matt White Ø80 mm	35.49.001.08.31	35.49.002.08.63	35.49.002.08.71

LED TUBE (T8 G13) NOT INCLUDED

- ⁽¹⁾ PHILIPS G13 600mm 8W 1050lm 840
- ⁽²⁾ PHILIPS G13 900mm 12W 1575lm 840
- ⁽³⁾ PHILIPS G13 1200mm 15,5W 2500lm 840
- ⁽⁴⁾ PHILIPS G13 1500mm 23W 3700lm 840

More information about the LED Tube or available electrical schemes on page 180.

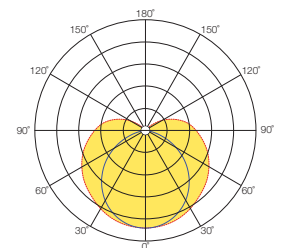
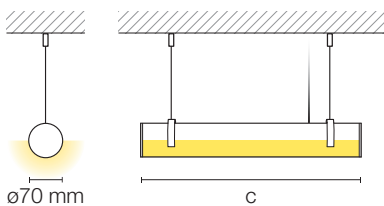
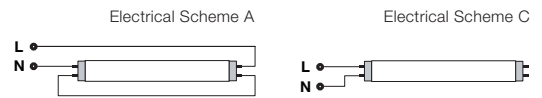

TUPOLI IP40 SURFACE



PT

- Luminária tubular para aplicações de iluminação geral em interiores.
- De aplicação saliente no teto ou na parede com peças de fixação em policarbonato ou inox.
- Difusor cilíndrico em policarbonato transparente resistente ao impacto.
- Refletor interno para maior desempenho da luminária.
- Topos em alumínio com acabamento branco mate.
- Disponível em quatro comprimentos para funcionamento com tubos LED T8 (não incluídos).

EN

- Tubular luminaire suitable for general interior lighting.
- Ceiling or wall surface mounted luminaire with polycarbonate or stainless steel mounting brackets.
- Clear impact-resistant polycarbonate cylindrical diffuser.
- Inner reflector to increase the luminaire performance.
- Matt white powder coated aluminium end caps.
- Available in four lengths for use with T8 LED tubes (not included).

QUICK INFO

GENERAL

Surface
IP40
IK08
850°C
Class I
Ta= -20°C +35°C

OPTIC

Clear Polycarbonate

LIGHT SOURCE

LED Tubes (T8 G13)

ELECTRICAL SYSTEM

220-240V/50-60Hz
ON/OFF

FINISHING

RAL 9003 Matt White

**TUPOLI SURFACE
CLEAR DIFFUSER**

IP40

c (mm)	Tubes	Power (W)	Output (lm)	Scheme A	Scheme C
683	1	1x10 MAX	976 ⁽¹⁾	33.49.000.01.07	33.49.000.01.24
988	1	1x14 MAX	1463 ⁽²⁾	33.49.000.01.08	33.49.000.01.25
1293	1	1x22 MAX	2323 ⁽³⁾	33.49.000.01.12	33.49.000.01.26
1598	1	1x24 MAX	3438 ⁽⁴⁾	33.49.000.01.13	33.49.000.01.27

COMPONENTS



SURFACE CEILING CUP (1pc)

TYPE	1m	3m	5m
Matt White Ø62x36 mm	35.49.001.08.30	35.49.002.08.59	35.49.002.08.67



RECESSED CEILING CUP (1pc)

TYPE	1m	3m	5m
Matt White Ø80 mm	35.49.001.08.31	35.49.002.08.63	35.49.002.08.71



MOUNTING SYSTEM (2pcs)

TYPE	FIG	COD
Polycarbonate Mounting Brackets	1	35.49.003.01.46
Stainless Steel Mounting Brackets	2	35.49.003.01.47



DETAILS



POLYCARBONATE MOUNTING BRACKETS



STAINLESS STEEL MOUNTING BRACKETS

LED TUBE (T8 G13) NOT INCLUDED

- ⁽¹⁾ PHILIPS G13 600mm 8W 1050lm 840
- ⁽²⁾ PHILIPS G13 900mm 12W 1575lm 840
- ⁽³⁾ PHILIPS G13 1200mm 15,5W 2500lm 840
- ⁽⁴⁾ PHILIPS G13 1500mm 23W 3700lm 840

More information about the LED Tube or available electrical schemes on page 180.

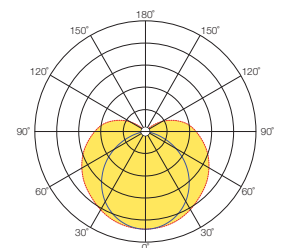
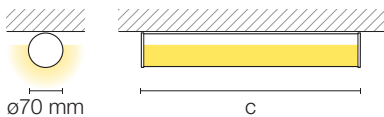
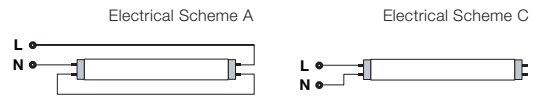

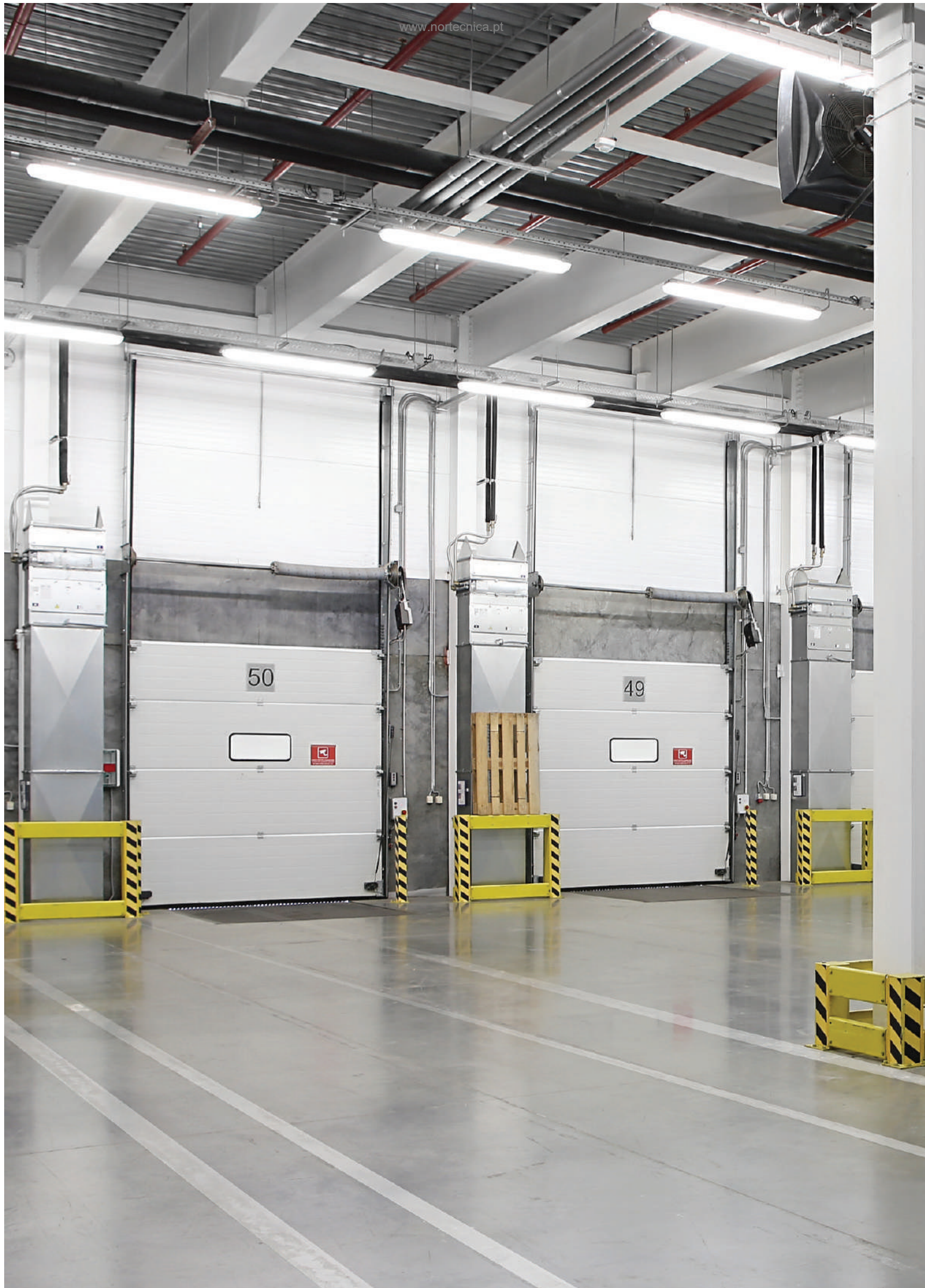

WATERPROOF

TUPOLI 70
IP65, IP66
SUSPENDED



TUPOLI 70
IP65, IP66
SURFACE



ATE BASIC
IP65, IP66, IK10
SURFACE



TUPOLI IP65, IP66 SUSPENDED



PT

- Luminária tubular com elevado grau de proteção.
- De aplicação suspensa por cabos de aço inox com ajuste rápido da altura.
- Índice de proteção IP65 ou IP66 e resistência a impactos IK10.
- Difusor cilíndrico em policarbonato transparente.
- Refletor interno para maior desempenho da luminária.
- Topo em policarbonato com buçim para garantir o IP da luminária.
- Disponível em três comprimentos para funcionamento com tubos LED T8 (não incluídos).

EN

- High protection rating tubular luminaire.
- Suspended luminaire with stainless steel cables with integrated tool-less height adjustment.
- IP65 or IP66 protection rating a IK10 impact resistance level.
- Clear polycarbonate cylindrical diffuser.
- Inner reflector to increase the luminaire performance.
- Polycarbonate end cap with cable gland to ensure the IP of the luminaire.
- Available in three lengths for use with T8 LED tubes (not included).

QUICK INFO

GENERAL

Suspended
 IP65, IP66
 IK10
 850°C
 Class I
 Ta= -20°C +35°C

OPTIC

Clear Polycarbonate

LIGHT SOURCE

LED Tubes (T8 G13)

ELECTRICAL SYSTEM

220-240V/50-60Hz
 ON/OFF

**TUPOLI SUSPENDED
 CLEAR DIFFUSER**

IP65

c (mm)	Tubes	Power (W)	Output (lm)	Scheme A	Scheme C
1019	1	1×14 MAX	1463 ⁽¹⁾	33.49.000.01.09	33.49.000.01.38
1324	1	1×22 MAX	2323 ⁽²⁾	33.49.000.01.10	33.49.000.01.39
1629	1	1×24 MAX	3438 ⁽³⁾	33.49.000.01.11	33.49.000.01.40

IP66

c (mm)	Tubes	Power (W)	Output (lm)	Scheme A	Scheme C
1019	1	1×14 MAX	1463 ⁽¹⁾	33.49.000.01.18	33.49.000.01.41
1324	1	1×22 MAX	2323 ⁽²⁾	33.49.000.01.19	33.49.000.01.42
1629	1	1×24 MAX	3438 ⁽³⁾	33.49.000.01.20	33.49.000.01.43

COMPONENTS



SUSPENSION SYSTEM (2pcs)

TYPE	1m	3m	5m
Matt White + Stainless Steel Cable	35.49.003.01.72	35.49.003.01.73	35.49.003.01.74

LED TUBE (T8 G13) NOT INCLUDED

- ⁽¹⁾ PHILIPS G13 900mm 12W 1575lm 840
- ⁽²⁾ PHILIPS G13 1200mm 15,5W 2500lm 840
- ⁽³⁾ PHILIPS G13 1500mm 23W 3700lm 840

More information about the LED Tube or available electrical schemes on page 180.

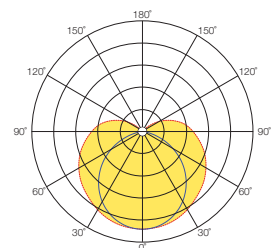
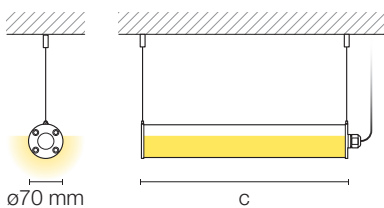
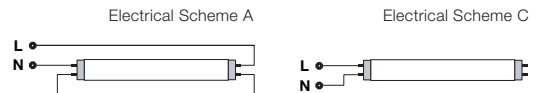

TUPOLI IP65, IP66 SURFACE



PT

- Luminária tubular com elevado grau de proteção.
- De aplicação saliente no teto ou na parede com peças de fixação em polycarbonato ou inox.
- Índice de proteção IP65 ou IP66 e resistência a impactos IK10.
- Difusor cilíndrico em polycarbonato transparente.
- Refletor interno para maior desempenho da luminária.
- Topo em polycarbonato com buçim para garantir o IP da luminária.
- Disponível em três comprimentos para funcionamento com tubos LED T8 (não incluídos).

EN

- High protection rating tubular luminaire.
- Ceiling or wall surface mounted luminaire with polycarbonate or stainless steel mounting brackets.
- IP65 or IP66 protection rating with IK10 impact resistance level.
- Clear polycarbonate cylindrical diffuser.
- Inner reflector to increase the luminaire performance.
- Polycarbonate end cap with cable gland to ensure the IP of the luminaire.
- Available in three lengths for use with T8 LED tubes (not included).

QUICK INFO

GENERAL

Surface
 IP65, IP66
 IK10
 850°C
 Class I
 Ta= -20°C +35°C

OPTIC

Clear Polycarbonate

LIGHT SOURCE

LED Tubes (T8 G13)

ELECTRICAL SYSTEM

220-240V/50-60Hz
 ON/OFF

**TUPOLI SURFACE
 CLEAR DIFFUSER**

IP65

c (mm)	Tubes	Power (W)	Output (lm)	Scheme A	Scheme C
1019	1	1×14 MAX	1463 ⁽¹⁾	33.49.000.01.15	33.49.000.01.28
1324	1	1×22 MAX	2323 ⁽²⁾	33.49.000.01.16	33.49.000.01.29
1629	1	1×24 MAX	3438 ⁽³⁾	33.49.000.01.17	33.49.000.01.30

IP66

c (mm)	Tubes	Power (W)	Output (lm)	Scheme A	Scheme C
1019	1	1×14 MAX	1463 ⁽¹⁾	33.49.000.01.21	33.49.000.01.31
1324	1	1×22 MAX	2323 ⁽²⁾	33.49.000.01.22	33.49.000.01.32
1629	1	1×24 MAX	3438 ⁽³⁾	33.49.000.01.23	33.49.000.01.33

DETAILS



POLYCARBONATE MOUNTING BRACKETS



STAINLESS STEEL MOUNTING BRACKETS

COMPONENTS

MOUNTING SYSTEM (2pcs)



TYPE	FIG	COD
Polycarbonate Mounting Brackets	1	35.49.003.01.46
Stainless Steel Mounting Brackets	2	35.49.003.01.47

LED TUBE (T8 G13) NOT INCLUDED

- ⁽¹⁾ PHILIPS G13 900mm 12W 1575lm 840
 - ⁽²⁾ PHILIPS G13 1200mm 15,5W 2500lm 840
 - ⁽³⁾ PHILIPS G13 1500mm 23W 3700lm 840
- More information about the LED Tube or available electrical schemes on page 180.

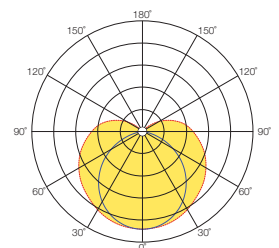
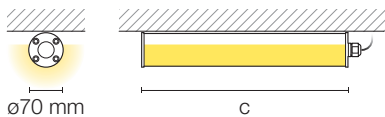
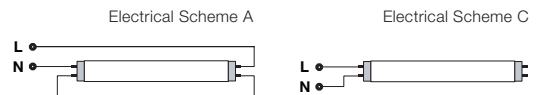

ATE BASIC IP65 SURFACE



PT

- Luminária estanque para locais com condições adversas de humidade.
- Índice de proteção IP65 com resistência a impactos IK08.
- Acessórios incluídos para aplicação saliente ou suspensa.
- Difusor Policarbonato Opal para iluminação homogénea e eficiente.
- Corpo em policarbonato injetado.
- Em versões de formato largo (140 mm) e estreito (90 mm).

EN

- Weatherproof luminaire for damp environments.
- IP65 protection rating with IK08 impact resistance level.
- Accessories included for surface or suspended mounting.
- Opal polycarbonate diffuser for efficient homogeneous lighting.
- Injection moulded polycarbonate canopy.
- Wide (140 mm) and narrow (90 mm) construction versions.

QUICK INFO

GENERAL

Suspended / Surface
 IP65
 IK08
 850°C
 Class I
 Ta= -20°C +35°C

OPTIC

Opal Polycarbonate

LIGHT SOURCE

LED Modules

SPECIFICATIONS

Efficacy up to 166 lm/W
 3000 K, 4000 K
 CRI >80
 Lifetime 72 000 H
 L80/B10 @Tc=50°C

ELECTRICAL SYSTEM

220-240V/50-60Hz
 ON/OFF, DALI

OPTIONS

EMERGENCY

1 Hour, 3 Hours
 DALI 1 Hour, 3 Hours

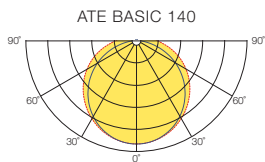
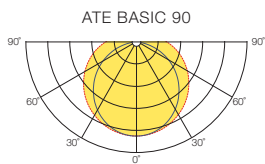

**ATE BASIC IP65 SURFACE
 OPAL DIFFUSER**

LED MODULES

Color Temp.	b×c (mm)	Output (lm)	System (W)	ON/OFF	DALI	
3000 K	90×664	1568	13	33.90.000.08.00	33.90.000.08.13	
		2091	18	33.90.000.08.01	33.90.000.08.14	
		2631	23	33.90.000.08.02	33.90.000.08.15	
	90×1274	3136	27	33.90.000.08.03	33.90.000.08.16	
		4181	35	33.90.000.08.04	33.90.000.08.17	
		5262	47	33.90.000.08.05	33.90.000.08.18	
	90×1574	3911	33	33.90.000.08.06	33.90.000.08.19	
		5226	44	33.90.000.08.07	33.90.000.08.20	
		6577	58	33.90.000.08.08	33.90.000.08.21	
		140×1274	7246	60	33.90.000.08.09	33.90.000.08.22
			8363	71	33.90.000.08.10	33.90.000.08.23
		140×1574	8353	68	33.90.000.08.11	33.90.000.08.24
10453	89		33.90.000.08.12	33.90.000.08.25		
4000 K	90×664	1648	13	33.90.000.08.52	33.90.000.08.65	
		2204	18	33.90.000.08.53	33.90.000.08.66	
		2773	23	33.90.000.08.54	33.90.000.08.67	
	90×1274	3296	27	33.90.000.08.55	33.90.000.08.68	
		4407	35	33.90.000.08.56	33.90.000.08.69	
		5546	47	33.90.000.08.57	33.90.000.08.70	
	90×1574	4115	33	33.90.000.08.58	33.90.000.08.71	
		5509	44	33.90.000.08.59	33.90.000.08.72	
		6933	58	33.90.000.08.60	33.90.000.08.73	
	140×1274	7639	60	33.90.000.08.61	33.90.000.08.74	
		8814	71	33.90.000.08.62	33.90.000.08.75	
		8804	68	33.90.000.08.63	33.90.000.08.76	
140×1574	11018	89	33.90.000.08.64	33.90.000.08.77		

OPTIONS



EMERGENCY (EM) - SELF-TEST INTEGRATED

ON/OFF	COD
EM 1H 3W	35.00.003.01.66*
EM 3H 3W	35.00.003.01.67*
DALI	COD
EM 1H 5,4W DALI	35.00.005.01.00*
EM 3H 5,4W DALI	35.00.005.01.01*

* Applies to lengths equal to or greater than 1274 mm.

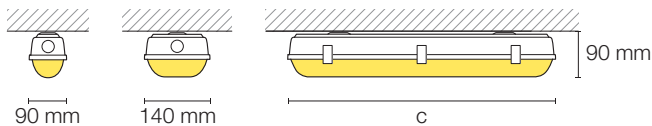

ATE BASIC IP66 SURFACE



PT

- Luminária estanque para locais com condições adversas de humidade.
- Índice de proteção IP66 com resistência a impactos IK08.
- Acessórios incluídos para aplicação saliente ou suspensa.
- Patilhas de fecho do difusor em aço inox (IP66).
- Difusor Policarbonato Opal para iluminação homogénea e eficiente.
- Corpo em policarbonato injetado.
- Em versões de formato largo (140 mm) e estreito (90 mm).

EN

- Weatherproof luminaire for damp environments.
- IP66 protection rating with IK08 impact resistance level.
- Accessories included for surface or suspended mounting.
- Stainless steel (IP66) diffuser clips.
- Opal polycarbonate diffuser for efficient homogeneous lighting.
- Injection moulded polycarbonate canopy.
- Wide (140 mm) and narrow (90 mm) construction versions.

QUICK INFO

GENERAL

Suspended / Surface
 IP66
 IK08
 850°C
 Class I
 Ta= -20°C +35°C

OPTIC

Opal Polycarbonate

LIGHT SOURCE

LED Modules

SPECIFICATIONS

Efficacy up to 166 lm/W
 3000 K, 4000 K
 CRI >80
 Lifetime 72 000 H
 L80/B10 @Tc=65°C

ELECTRICAL SYSTEM

220-240V/50-60Hz
 ON/OFF, DALI

OPTIONS

EMERGENCY

1 Hour, 3 Hours
 DALI 1 Hour, 3 Hours

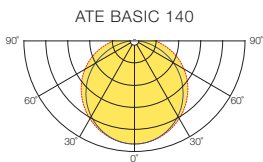
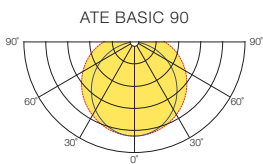

**ATE BASIC IP66 SURFACE
 OPAL DIFFUSER**

LED MODULES

Color Temp.	b×c (mm)	Output (lm)	System (W)	ON/OFF	DALI
3000 K	90×664	1568	13	33.90.000.08.26	33.90.000.08.39
		2091	18	33.90.000.08.27	33.90.000.08.40
		2631	23	33.90.000.08.28	33.90.000.08.41
	90×1274	3136	27	33.90.000.08.29	33.90.000.08.42
		4181	35	33.90.000.08.30	33.90.000.08.43
		5262	47	33.90.000.08.31	33.90.000.08.44
	90×1574	3911	33	33.90.000.08.32	33.90.000.08.45
		5226	44	33.90.000.08.33	33.90.000.08.46
		6577	58	33.90.000.08.34	33.90.000.08.47
	140×1274	7246	60	33.90.000.08.35	33.90.000.08.48
		8363	71	33.90.000.08.36	33.90.000.08.49
		8353	68	33.90.000.08.37	33.90.000.08.50
140×1574	10453	89	33.90.000.08.38	33.90.000.08.51	
	90×664	1648	13	33.90.000.08.78	33.90.000.08.91
		2204	18	33.90.000.08.79	33.90.000.08.92
2773		23	33.90.000.08.80	33.90.000.08.93	
90×1274	3296	27	33.90.000.08.81	33.90.000.08.94	
	4407	35	33.90.000.08.82	33.90.000.08.95	
	5546	47	33.90.000.08.83	33.90.000.08.96	
90×1574	4115	33	33.90.000.08.84	33.90.000.08.97	
	5509	44	33.90.000.08.85	33.90.000.08.98	
	6933	58	33.90.000.08.86	33.90.000.08.99	
140×1274	7639	60	33.90.000.08.87	33.90.001.08.00	
	8814	71	33.90.000.08.88	33.90.001.08.01	
	8804	68	33.90.000.08.89	33.90.001.08.02	
140×1574	11018	89	33.90.000.08.90	33.90.001.08.03	

OPTIONS



EMERGENCY (EM) - SELF-TEST INTEGRATED

ON/OFF	COD
EM 1H 3W	35.00.003.01.66*
EM 3H 3W	35.00.003.01.67*
DALI	COD
EM 1H 5,4W DALI	35.00.005.01.00*
EM 3H 5,4W DALI	35.00.005.01.01*

* Applies to lengths equal to or greater than 1274 mm.

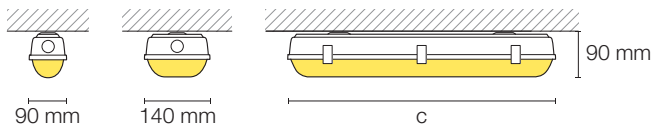

ATE BASIC IP66 IK10 SURFACE



PT

- Luminária estanque para locais com condições adversas de humidade.
- Índice de proteção IP66 com resistência a impactos IK10.
- Acessórios incluídos para aplicação saliente ou suspensa.
- Patilhas de fecho do difusor em aço inox (IP66).
- Difusor Policarbonato Opal para iluminação homogénea e eficiente.
- Corpo em policarbonato injetado.
- Em versões de formato largo (140 mm) e estreito (90 mm).

EN

- Weatherproof luminaire for damp environments.
- IP66 protection rating with IK10 impact resistance level.
- Accessories included for surface or suspended mounting.
- Stainless steel (IP66) diffuser clips.
- Opal polycarbonate diffuser for efficient homogeneous lighting.
- Injection moulded polycarbonate canopy.
- Wide (140 mm) and narrow (90 mm) construction versions.

QUICK INFO

GENERAL

Suspended / Surface
 IP66
 IK10
 850°C
 Class I
 Ta= -20°C +35°C

OPTIC

Opal Polycarbonate

LIGHT SOURCE

LED Modules

SPECIFICATIONS

Efficacy up to 166 lm/W
 3000 K, 4000 K
 CRI >80
 Lifetime 72 000 H
 L80/B10 @Tc=65°C

ELECTRICAL SYSTEM

220-240V/50-60Hz
 ON/OFF, DALI

**ATE BASIC IP66 IK10 SURFACE
 OPAL DIFFUSER**

LED MODULES

Color Temp.	b×c (mm)	Output (lm)	System (W)	ON/OFF	DALI
3000 K	90×664	1568	13	33.90.001.08.04	33.90.001.08.17
		2091	18	33.90.001.08.05	33.90.001.08.18
		2631	23	33.90.001.08.06	33.90.001.08.19
		3136	27	33.90.001.08.07	33.90.001.08.20
		4181	35	33.90.001.08.08	33.90.001.08.21
		5262	47	33.90.001.08.09	33.90.001.08.22
	90×1274	3911	33	33.90.001.08.10	33.90.001.08.23
		5226	44	33.90.001.08.11	33.90.001.08.24
		6577	58	33.90.001.08.12	33.90.001.08.25
		7246	60	33.90.001.08.13	33.90.001.08.26
		8363	71	33.90.001.08.14	33.90.001.08.27
		8353	68	33.90.001.08.15	33.90.001.08.28
4000 K	140×1274	10453	89	33.90.001.08.16	33.90.001.08.29
		1648	13	33.90.001.08.30	33.90.001.08.43
		2204	18	33.90.001.08.31	33.90.001.08.44
		2773	23	33.90.001.08.32	33.90.001.08.45
		3296	27	33.90.001.08.33	33.90.001.08.46
		4407	35	33.90.001.08.34	33.90.001.08.47
	90×1574	5546	47	33.90.001.08.35	33.90.001.08.48
		4115	33	33.90.001.08.36	33.90.001.08.49
		5509	44	33.90.001.08.37	33.90.001.08.50
		6933	58	33.90.001.08.38	33.90.001.08.51
		7639	60	33.90.001.08.39	33.90.001.08.52
		8814	71	33.90.001.08.40	33.90.001.08.53
140×1574	8804	68	33.90.001.08.41	33.90.001.08.54	
	11018	89	33.90.001.08.42	33.90.001.08.55	

OPTIONS

EMERGENCY

1 Hour, 3 Hours
 DALI 1 Hour, 3 Hours

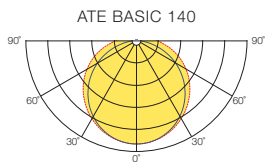
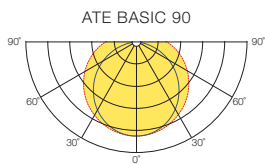

OPTIONS



EMERGENCY (EM) - SELF-TEST INTEGRATED

ON/OFF	COD
EM 1H 3W	35.00.003.01.66*
EM 3H 3W	35.00.003.01.67*
DALI	COD
EM 1H 5,4W DALI	35.00.005.01.00*
EM 3H 5,4W DALI	35.00.005.01.01*

* Applies to lengths equal to or greater than 1274 mm.

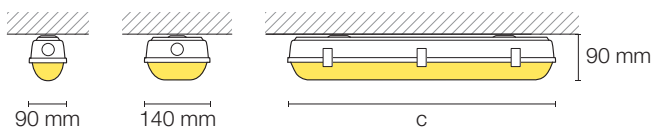

ATE BASIC IP65 SURFACE

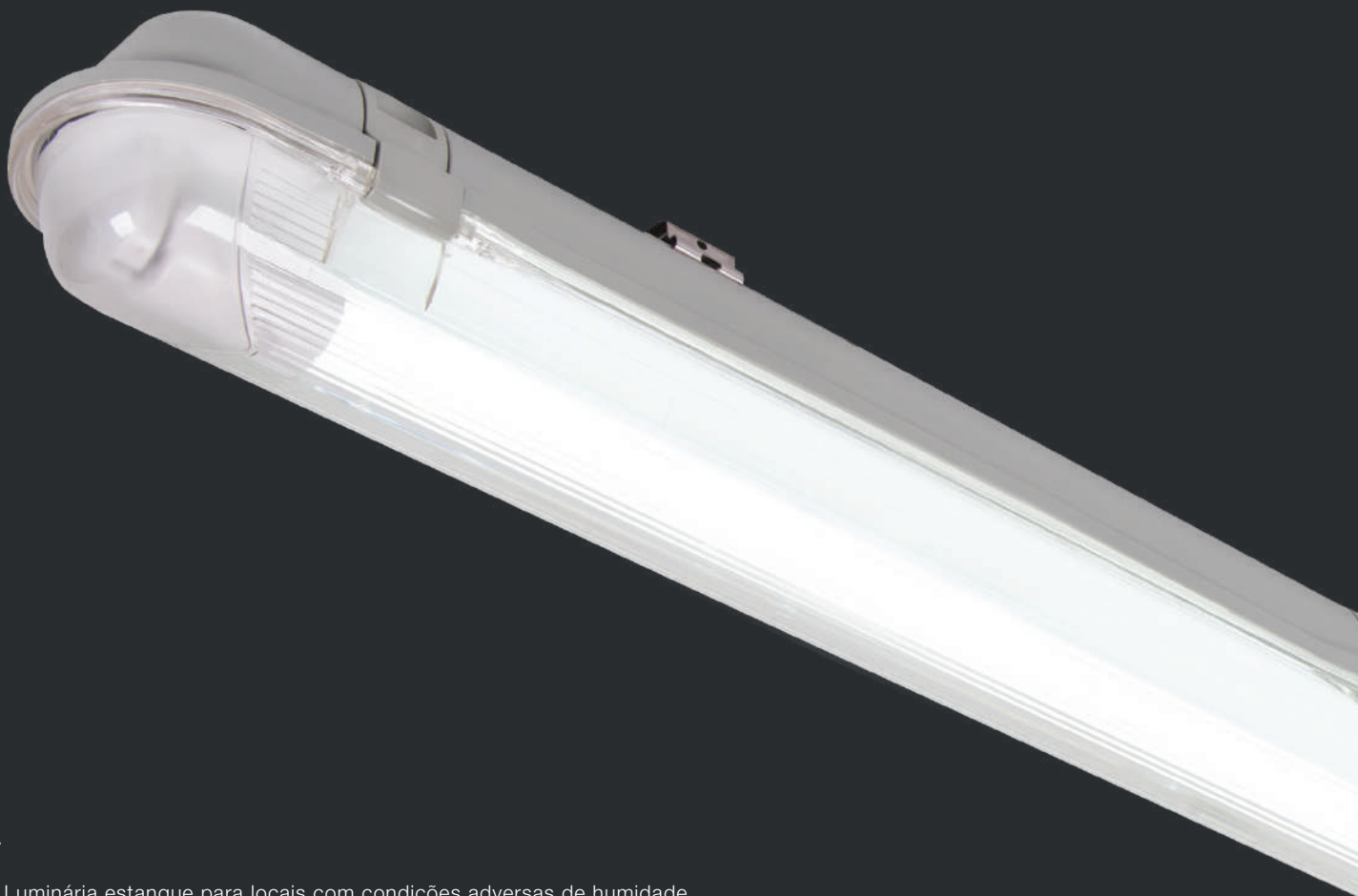

PT

- Luminária estanque para locais com condições adversas de humidade.
- Índice de proteção IP65 com resistência a impactos IK08.
- Acessórios incluídos para aplicação saliente ou suspensa.
- Difusor Policarbonato Cristal de elevada resistência a impactos.
- Corpo em policarbonato injetado.
- Versões de formato largo (140 mm) e estreito (90 mm) para tubos LED T8 (não incluídos).

EN

- Weatherproof luminaire for damp environments.
- IP65 protection rating with IK08 impact resistance level.
- Accessories included for surface or suspended mounting.
- Impact-resistant clear polycarbonate diffuser.
- Injection moulded polycarbonate canopy.
- Wide (140 mm) and narrow (90 mm) construction versions for T8 LED tubes (not included).

QUICK INFO

GENERAL

Suspended / Surface
 IP65
 IK08
 850°C
 Class I
 Ta= -20°C +35°C

OPTIC

Clear Polycarbonate

LIGHT SOURCE

LED Tubes (T8 G13)

ELECTRICAL SYSTEM

220-240V/50-60Hz
 ON/OFF

**ATE BASIC IP65 SURFACE
 CLEAR DIFFUSER**

LED TUBES

b×c (mm)	Tubes	Power (W)	Output (lm)	Scheme A	Scheme C
90×664	1	1×10 MAX	858 ⁽¹⁾	33.90.000.01.00	33.90.000.01.18
90×1274	1	1×22 MAX	2042 ⁽²⁾	33.90.000.01.01	33.90.000.01.19
90×1574	1	1×24 MAX	3023 ⁽³⁾	33.90.000.01.02	33.90.000.01.20
140×664	2	2×10 MAX	1568 ⁽¹⁾	33.90.000.01.03	33.90.000.01.21
140×1274	2	2×22 MAX	3733 ⁽²⁾	33.90.000.01.04	33.90.000.01.22
140×1574	2	2×24 MAX	5525 ⁽³⁾	33.90.000.01.05	33.90.000.01.23

LED TUBE (T8 G13) NOT INCLUDED

- ⁽¹⁾ PHILIPS G13 600mm 8W 1050lm 840
- ⁽²⁾ PHILIPS G13 1200mm 15,5W 2500lm 840
- ⁽³⁾ PHILIPS G13 1500mm 23W 3700lm 840

More information about the LED Tube or available electrical schemes on page 180.

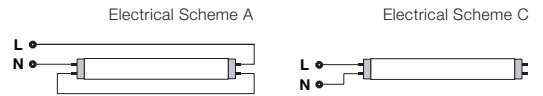

DETAILS

- 1 – Polycarbonate diffuser clips for IP65 protection.
- 2 – Accessories included for all mounting options.

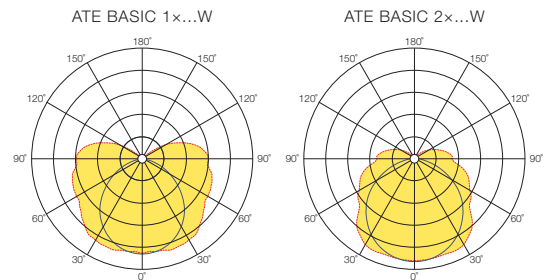
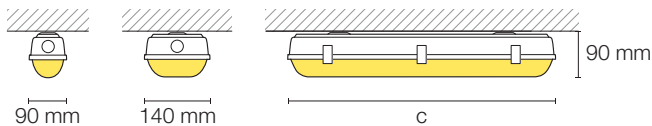
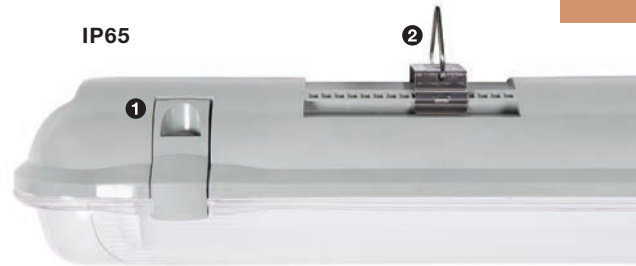

ATE BASIC IP66 SURFACE



PT

- Luminária estanque para locais com condições adversas de humidade.
- Índice de proteção IP66 com resistência a impactos IK08.
- Acessórios incluídos para aplicação saliente ou suspensa.
- Patilhas de fecho do difusor em aço inox (IP66).
- Difusor Policarbonato Cristal de elevada resistência a impactos.
- Corpo em policarbonato injetado.
- Versões de formato largo (140 mm) e estreito (90 mm) para tubos LED T8 (não incluídos).

EN

- Weatherproof luminaire for damp environments.
- IP66 protection rating with IK08 impact resistance level.
- Accessories included for surface or suspended mounting.
- Stainless steel (IP66) diffuser clips.
- Impact-resistant clear polycarbonate diffuser.
- Injection moulded polycarbonate canopy.
- Wide (140 mm) and narrow (90 mm) construction versions for T8 LED tubes (not included).

QUICK INFO

GENERAL

Suspended / Surface
 IP66
 IK08
 850°C
 Class I
 Ta= -20°C +35°C

OPTIC

Clear Polycarbonate

LIGHT SOURCE

LED Tubes (T8 G13)

ELECTRICAL SYSTEM

220-240V/50-60Hz
 ON/OFF

**ATE BASIC IP66 SURFACE
 CLEAR DIFFUSER**

LED TUBES

b×c (mm)	Tubes	Power (W)	Output (lm)	Scheme A	Scheme C
90×664	1	1×10 MAX	858 ⁽¹⁾	33.90.000.01.06	33.90.000.01.24
90×1274	1	1×22 MAX	2042 ⁽²⁾	33.90.000.01.07	33.90.000.01.25
90×1574	1	1×24 MAX	3023 ⁽³⁾	33.90.000.01.08	33.90.000.01.26
140×664	2	2×10 MAX	1568 ⁽¹⁾	33.90.000.01.09	33.90.000.01.27
140×1274	2	2×22 MAX	3733 ⁽²⁾	33.90.000.01.10	33.90.000.01.28
140×1574	2	2×24 MAX	5525 ⁽³⁾	33.90.000.01.11	33.90.000.01.29

LED TUBE (T8 G13) NOT INCLUDED

- ⁽¹⁾ PHILIPS G13 600mm 8W 1050lm 840
 - ⁽²⁾ PHILIPS G13 1200mm 15,5W 2500lm 840
 - ⁽³⁾ PHILIPS G13 1500mm 23W 3700lm 840
- More information about the LED Tube or available electrical schemes on page 180.

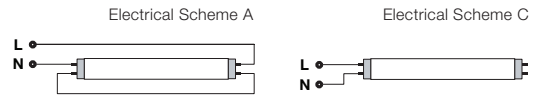

DETAILS

- 1 – Stainless Steel diffuser clips for IP66 protection.
- 2 – Accessories included for all mounting options.

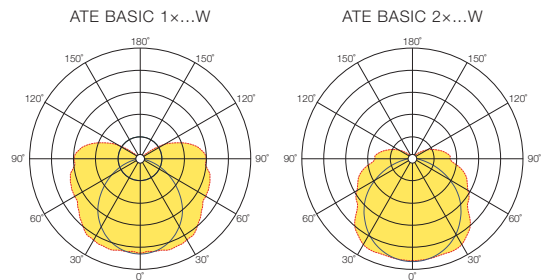
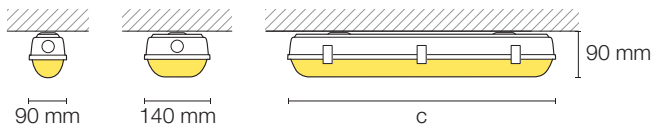
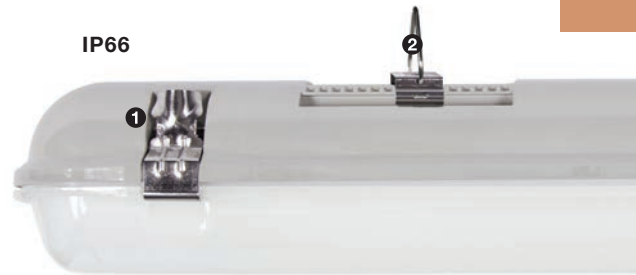

ATE BASIC IP66 IK10 SURFACE



PT

- Luminária estanque para locais com condições adversas de humidade.
- Índice de proteção IP66 com resistência a impactos IK10.
- Acessórios incluídos para aplicação saliente ou suspensa.
- Patilhas de fecho do difusor em aço inox (IP66).
- Difusor Policarbonato Cristal de elevada resistência a impactos.
- Corpo em policarbonato injetado.
- Versões de formato largo (140 mm) e estreito (90 mm) para tubos LED T8 (não incluídos).

EN

- Weatherproof luminaire for damp environments.
- IP66 protection rating with IK10 impact resistance level.
- Accessories included for surface or suspended mounting.
- Stainless steel (IP66) diffuser clips.
- Impact-resistant clear polycarbonate diffuser.
- Injection moulded polycarbonate canopy.
- Wide (140 mm) and narrow (90 mm) construction versions for T8 LED tubes (not included).

QUICK INFO

GENERAL

Suspended / Surface
 IP66
 IK10
 850°C
 Class I
 Ta= -20°C +35°C

OPTIC

Clear Polycarbonate

LIGHT SOURCE

LED Tubes (T8 G13)

ELECTRICAL SYSTEM

220-240V/50-60Hz
 ON/OFF

**ATE BASIC IP66 IK10 SURFACE
 CLEAR DIFFUSER**

LED TUBES

b×c (mm)	Tubes	Power (W)	Output (lm)	Scheme A	Scheme C
90×664	1	1×10 MAX	858 ⁽¹⁾	33.90.000.01.12	33.90.000.01.30
90×1274	1	1×22 MAX	2042 ⁽²⁾	33.90.000.01.13	33.90.000.01.31
90×1574	1	1×24 MAX	3023 ⁽³⁾	33.90.000.01.14	33.90.000.01.32
140×664	2	2×10 MAX	1568 ⁽¹⁾	33.90.000.01.15	33.90.000.01.33
140×1274	2	2×22 MAX	3733 ⁽²⁾	33.90.000.01.16	33.90.000.01.34
140×1574	2	2×24 MAX	5525 ⁽³⁾	33.90.000.01.17	33.90.000.01.35

LED TUBE (T8 G13) NOT INCLUDED

- ⁽¹⁾ PHILIPS G13 600mm 8W 1050lm 840
- ⁽²⁾ PHILIPS G13 1200mm 15,5W 2500lm 840
- ⁽³⁾ PHILIPS G13 1500mm 23W 3700lm 840

More information about the LED Tube or available electrical schemes on page 180.

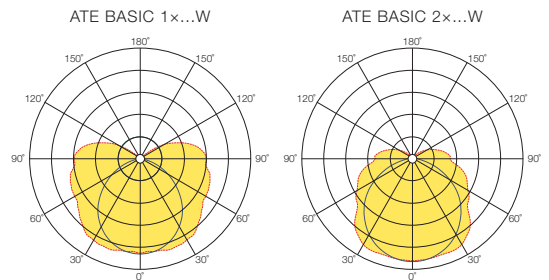
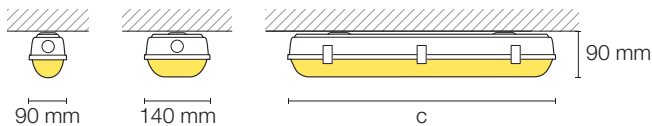
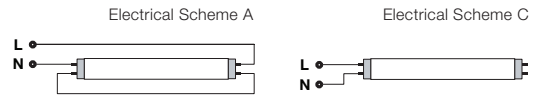



PLAFONIERS

ATAC
SURFACE



ATAC

SURFACE



PT

- Luminária de grande funcionalidade para aplicações de iluminação geral em interiores.
- Aplicação saliente no teto ou na parede.
- Difusão de luz em todas as faces do difusor, maximizando a eficiência da luminária.
- Versões PCB LED equipadas com difusor opal para luz difusa.
- Versões para tubos circulares LED (não incluídos) com difusor prismático.
- Sistema de patilhas de fecho rápido do difusor para facilidade de instalação.

EN

- High-functionality luminaire suitable for general interior lighting.
- For direct ceiling or wall mounting.
- Light diffusion on all faces of the diffuser, maximizing luminaire efficiency.
- PCB LED versions equipped with opal diffuser for diffuse lighting.
- Versions for use with circular LED tubes (not included) with prismatic diffuser.
- Quick-release diffuser latches for easy installation.

QUICK INFO

GENERAL

Surface
IP30
IK05
850°C
Class I
Ta= -20°C +35°C

OPTIC

Opal PMMA - LED Modules
Clear Prismatic PMMA - LED Tubes

LIGHT SOURCE

LED Modules
LED Tubes (T9 G10q)

SPECIFICATIONS

Efficacy up to 176 lm/W
3000 K, 4000 K
CRI >80
Lifetime 72 000 H
L80/B10 @TC=55°C
24 VDC

ELECTRICAL SYSTEM

220-240V/50-60Hz
ON/OFF

FINISHING

RAL 9016 White

ATAC SURFACE

OPAL DIFFUSER

LED MODULES

Color Temp.	Ø×a (mm)	Output (lm)	System (W)	ON/OFF
3000 K	ø270×75	945	9	33.50.000.08.22
	ø370×80	3762	32	33.50.000.08.24
4000 K	ø270×75	987	9	33.50.000.08.23
	ø370×80	3802	32	33.50.000.08.25

CLEAR PRISMATIC DIFFUSER

LED TUBES

Ø×a(mm)	Tubes	Power (W)	Output (lm)	Scheme E	Scheme F
ø270×75	1	1x14 MAX	1280 ⁽¹⁾	33.50.000.01.05	33.50.000.01.10
ø370×80	1	1x20 MAX	2047 ⁽²⁾	33.50.000.01.06	33.50.000.01.11

LED TUBE (T9 G10q) NOT INCLUDED

- ⁽¹⁾ OSRAM G10q Ø220mm 12W 1200lm 840
 - ⁽²⁾ OSRAM G10q Ø320mm 20W 2000lm 840
- More information about the LED Tube or available electrical schemes on page 180.

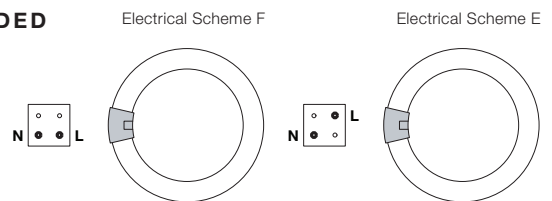

- Clear Prismatic PMMA Diffuser for LED Tubes.

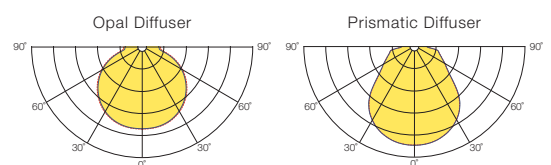
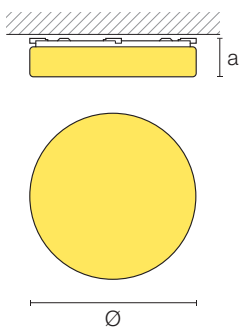



BATTEN AND INDUSTRIAL

SLIM
SURFACE



SLIM IP40
SURFACE

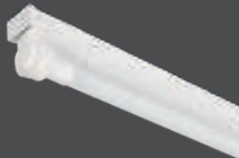

SLIM T5
SURFACE



AIN REFLECTOR
SURFACE

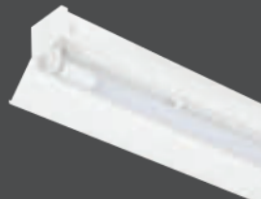

AIN IP40 REFLECTOR
SURFACE



SLIM T8 IP20 SURFACE



PT

- Rêgua de dimensões reduzidas para iluminação geral em interiores.
- Adequado para aplicação saliente no teto ou na parede.
- Luminária de pequena secção ideal para iluminação em sancas e superfícies de trabalho em cozinhas, oficinas e garagens.
- Corpo em chapa de aço com revestimento a epoxy-poliéster.
- Disponível em versões para um ou dois tubos LED T8 (não incluídos).

EN

- Range of slim battens for general interior lighting.
- Suitable for ceiling or wall surface mounting.
- Slender luminaire ideal for cove lighting and for illuminating work surfaces in kitchens, workshops and garages.
- Body made of steel sheet with epoxy-polyester powder coating.
- Available in versions for one or two T8 LED tubes (not included).

QUICK INFO

GENERAL

Surface
IP20
IK05
850°C
Class I
Ta= -20°C +35°C

LIGHT SOURCE

LED Tubes (T8 G13)

ELECTRICAL SYSTEM

220-240V/50-60Hz
ON/OFF

FINISHING

RAL 9016 White

SLIM IP20 SURFACE

LED TUBES

c (mm)	Tubes	Power (W)	Output (lm)	Scheme A	Scheme C
628	1	1x10 MAX	1025 ⁽¹⁾	33.87.000.01.00	33.87.000.01.08
1238	1	1x22 MAX	2442 ⁽²⁾	33.87.000.01.01	33.87.000.01.09
1538	1	1x24 MAX	3614 ⁽³⁾	33.87.000.01.12	33.87.000.01.14
628	2	2x10 MAX	2178 ⁽¹⁾	33.87.000.01.24	33.87.000.01.28
1238	2	2x22 MAX	5187 ⁽²⁾	33.87.000.01.25	33.87.000.01.29
1538	2	2x24 MAX	7677 ⁽³⁾	33.87.000.01.26	33.87.000.01.30

LED TUBE (T8 G13) NOT INCLUDED

- ⁽¹⁾ PHILIPS G13 600mm 8W 1050lm 840
- ⁽²⁾ PHILIPS G13 1200mm 15,5W 2500lm 840
- ⁽³⁾ PHILIPS G13 1500mm 23W 3700lm 840

More information about the LED Tube or available electrical schemes on page 180.

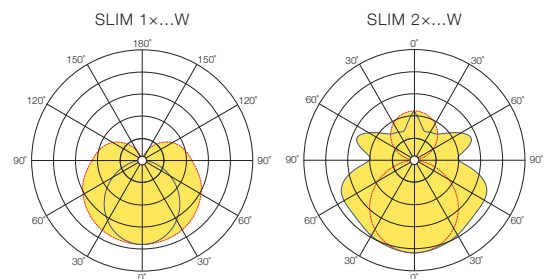
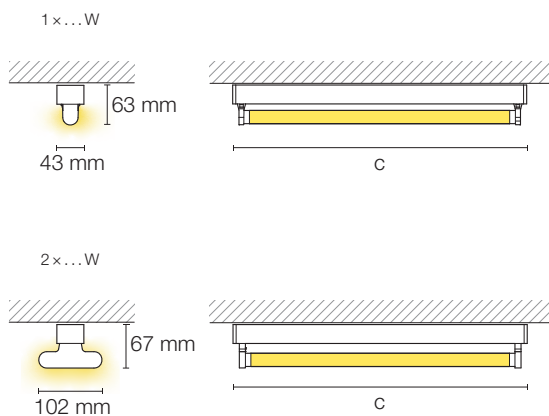
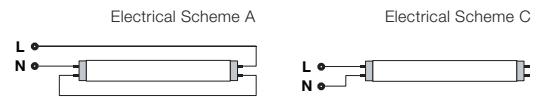

SLIM T8 IP40 SURFACE



PT

- Luminária com IP40 para iluminação geral em interiores.
- Adequado para aplicação saliente no teto ou na parede.
- Luminária de pequena secção ideal para iluminação em sancas e superfícies de trabalho em cozinhas, oficinas e garagens.
- Corpo em chapa de aço com revestimento a epoxy-poliéster.
- Disponível em versões para um ou dois tubos LED T8 (não incluídos).

EN

- IP40 Luminaire for general interior lighting.
- Range of slim battens for general interior lighting.
- Suitable for ceiling or wall surface mounting.
- Slender luminaire ideal for cove lighting and for illuminating work surfaces in kitchens, workshops and garages.
- Body made of sheet steel with epoxy-polyester powder coating.
- Available in versions for one or two T8 LED tubes (not included).

QUICK INFO

GENERAL

Surface
IP40
IK05
850°C
Class I
Ta= -20°C +35°C

LIGHT SOURCE

LED Tubes (T8 G13)

ELECTRICAL SYSTEM

220-240V/50-60Hz
ON/OFF

FINISHING

RAL 9016 White

SLIM IP40 SURFACE

LED TUBES

c (mm)	Tubes	Power (W)	Output (lm)	Scheme A	Scheme C
628	1	1x10 MAX	1025 ⁽¹⁾	33.87.000.01.31	33.87.000.01.37
1238	1	1x22 MAX	2442 ⁽²⁾	33.87.000.01.32	33.87.000.01.38
1538	1	1x24 MAX	3614 ⁽³⁾	33.87.000.01.33	33.87.000.01.39
628	2	2x10 MAX	2178 ⁽¹⁾	33.87.000.01.34	33.87.000.01.40
1238	2	2x22 MAX	5187 ⁽²⁾	33.87.000.01.35	33.87.000.01.41
1538	2	2x24 MAX	7677 ⁽³⁾	33.87.000.01.36	33.87.000.01.42

LED TUBE (T8 G13) NOT INCLUDED

LED Tube for this type of luminaire should have max. ø28 mm.

- ⁽¹⁾ PHILIPS G13 600mm 8W 1050lm 840
- ⁽²⁾ PHILIPS G13 1200mm 15,5W 2500lm 840
- ⁽³⁾ PHILIPS G13 1500mm 23W 3700lm 840

More information about the LED Tube or available electrical schemes on page 180.

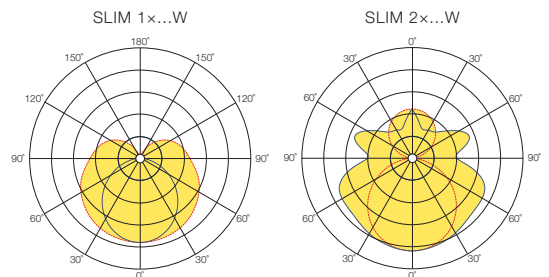
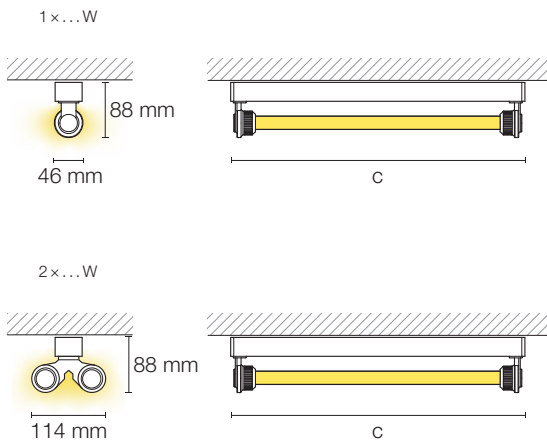
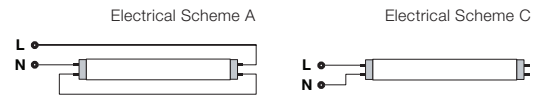

SLIM T5 SURFACE



PT

- Régua de dimensões reduzidas para iluminação geral em interiores.
- Adequado para aplicação saliente no teto ou na parede.
- Luminária de pequena secção ideal para iluminação em sancas e superfícies de trabalho em cozinhas, oficinas e garagens.
- Corpo em chapa de aço com revestimento a epoxy-poliéster e topos em ABS.
- Disponível em versões para uma ou duas lâmpadas T5 fluorescente (não incluídas).

EN

- Range of slim battens for general interior lighting.
- Suitable for ceiling or wall surface mounting.
- Slender luminaire ideal for cove lighting and for illuminating work surfaces in kitchens, workshops and garages.
- Body made of steel sheet with epoxy-polyester powder coating and ABS end-caps.
- Available in versions for one or two T5 fluorescent lamps (not included).

QUICK INFO

GENERAL

Surface
IP20
IK05
850°C
Ta= -20°C +35°C

LIGHT SOURCE

Fluorescent Lamps (T5 G5)

ELECTRICAL SYSTEM

220-240V/50-60Hz
ON/OFF, DALI

FINISHING

RAL 9016 White

SLIM SURFACE

T5 FLUORESCENT

c (mm)	Tubes	Power (W)	Output (lm)	ON/OFF	DALI
576	1	1x14	1097 ⁽¹⁾	33.87.114.04.16	33.87.114.05.07
	1	1x24	1599 ⁽²⁾	33.87.124.04.00	
1176	1	1x28	2376 ⁽³⁾	33.87.128.04.01	33.87.128.05.02
	1	1x54	4066 ⁽⁴⁾	33.87.154.04.00	
1476	1	1x35	3016 ⁽⁵⁾	33.87.135.04.02	33.87.135.05.02
	1	1x49	3929 ⁽⁶⁾	33.87.149.04.00	
	1	1x80	5620 ⁽⁷⁾	33.87.180.04.00	
576	2	2x14	2273 ⁽¹⁾	33.87.214.04.07	33.87.214.05.04
	2	2x24	3315 ⁽²⁾	33.87.224.04.05	
1176	2	2x28	4924 ⁽³⁾	33.87.228.04.04	33.87.228.05.00
	2	2x54	8428 ⁽⁴⁾	33.87.254.04.04	
1476	2	2x35	6288 ⁽⁵⁾	33.87.235.04.06	33.87.235.05.00
	2	2x49	8163 ⁽⁶⁾	33.87.249.04.05	
	2	2x80	11648 ⁽⁷⁾	33.87.280.04.10	

FLUORESCENT LAMP (T5 G5) NOT INCLUDED

- ⁽¹⁾ PHILIPS G5 549mm 14W 1200lm
- ⁽²⁾ PHILIPS G5 549mm 24W 1750lm
- ⁽³⁾ PHILIPS G5 1149mm 28W 2600lm
- ⁽⁴⁾ PHILIPS G5 1149mm 54W 4450lm
- ⁽⁵⁾ PHILIPS G5 1449mm 35W 3300lm
- ⁽⁶⁾ PHILIPS G5 1449mm 49W 4300lm
- ⁽⁷⁾ PHILIPS G5 1449mm 80W 6150lm

OPTIONS



EMERGENCY (EM)

ON/OFF	COD
EM 1H T5 - 35W	35.00.004.01.07
EM 1H T5 - 28W / 49W	35.00.004.01.10
EM 1H T5 - 54W / 80W	35.00.004.01.08

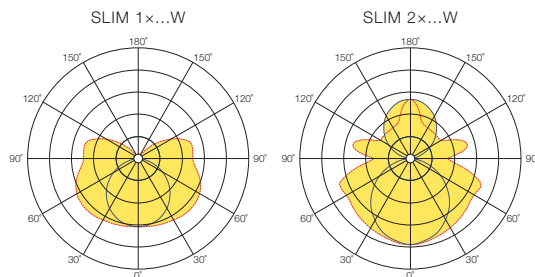
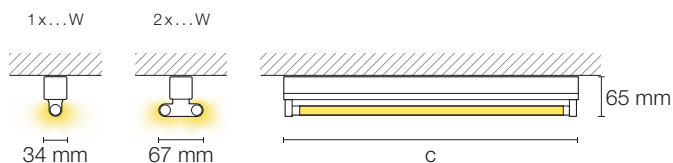

AIN REFLECTOR SURFACE



PT

- Luminária com IP20 para iluminação geral em interiores.
- Refletor simétrico disponível em alumínio branco ou brilhante.
- Corpo em chapa de aço com revestimento a epoxy-poliéster.
- Equipada com sistema de fecho que permite facilidade e rapidez de instalação.
- Disponível em versões para um ou dois tubos LED e lâmpadas fluorescentes T8 (não incluídos).

EN

- IP20 luminaire for general interior lighting.
- Symmetrical reflector available in white or mirrorbrite aluminium.
- Body made of steel sheet with epoxy-polyester powder coating.
- Quick-release reflector system enables an easy and quick installation.
- Available in versions for one or two T8 LED tubes and fluorescent lamps (not included).

QUICK INFO

GENERAL

Surface
IP20
650°C
Class I
Ta= -20°C +35°C

LIGHT SOURCE

LED Tubes (T8 G13)

ELECTRICAL SYSTEM

220-240V/50-60Hz
ON/OFF

FINISHING

RAL 9016 White

AIN REFLECTOR SURFACE

LED TUBES

WHITE REFLECTOR

c (mm)	Tubes	Power (W)	Output (lm)	Scheme A	Scheme C
1233	1	1x22 MAX	2475 ⁽¹⁾	33.70.000.01.17	33.70.000.01.40
1533	1	1x24 MAX	3663 ⁽²⁾	33.70.000.01.18	33.70.000.01.41
1233	2	2x22 MAX	4289 ⁽¹⁾	33.70.000.01.20	33.70.000.01.42
1533	2	2x24 MAX	6348 ⁽²⁾	33.70.000.01.21	33.70.000.01.43

ALUMINIUM REFLECTOR

c (mm)	Tubes	Power (W)	Output (lm)	Scheme A	Scheme C
1233	1	1x22 MAX	2272 ⁽¹⁾	33.70.000.01.23	33.70.000.01.44
1533	1	1x24 MAX	3363 ⁽²⁾	33.70.000.01.24	33.70.000.01.45
1233	2	2x22 MAX	4375 ⁽¹⁾	33.70.000.01.26	33.70.000.01.46
1533	2	2x24 MAX	6476 ⁽²⁾	33.70.000.01.27	33.70.000.01.47

DETAILS



WHITE REFLECTOR



ALUMINIUM REFLECTOR

LED TUBE (T8 G13) NOT INCLUDED

- ⁽¹⁾ PHILIPS G13 1200mm 15,5W 2500lm 840
- ⁽²⁾ PHILIPS G13 1500mm 23W 3700lm 840

More information about the LED Tube or available electrical schemes on page 180.

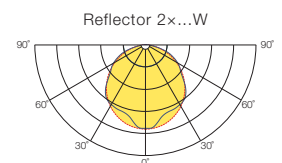
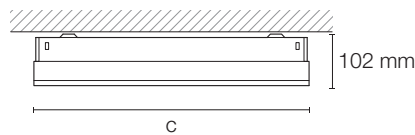
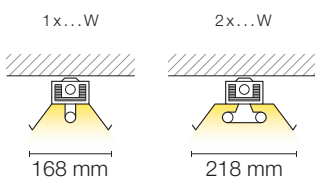
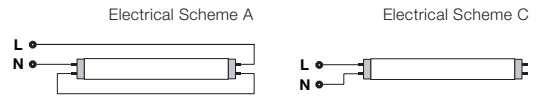

QUICK INFO

GENERAL

Surface
IP20
650°C
Class I
Ta= -20°C +35°C

LIGHT SOURCE

Fluorescent Lamps (T8 G13)

ELECTRICAL SYSTEM

220-240V/50-60Hz
ON/OFF

FINISHING

RAL 9016 White

AIN REFLECTOR SURFACE

T8 FLUORESCENT

WHITE REFLECTOR

c (mm)	Tubes	Power (W)	Output (lm)	ON/OFF
1233	1	1x36	2742 ⁽¹⁾	33.70.136.04.02
1533	1	1x58	4599 ⁽²⁾	33.70.158.04.12
1233	2	2x36	5366 ⁽¹⁾	33.70.236.04.06
1533	2	2x58	9000 ⁽²⁾	33.70.258.04.04

ALUMINIUM REFLECTOR

c (mm)	Tubes	Power (W)	Output (lm)	ON/OFF
1233	1	1x36	2650 ⁽¹⁾	33.70.136.04.04
1533	1	1x58	4446 ⁽²⁾	33.70.158.04.05
1233	2	2x36	5208 ⁽¹⁾	33.70.236.04.05
1533	2	2x58	8735 ⁽²⁾	33.70.258.04.09

DETAILS



WHITE REFLECTOR



ALUMINIUM REFLECTOR

FLUORESCENT LAMP (T8 G13) NOT INCLUDED

- ⁽¹⁾ OSRAM G13 1200mm 36W 3100lm
- ⁽²⁾ OSRAM G13 1500mm 58W 5200lm

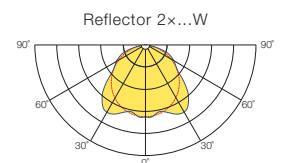
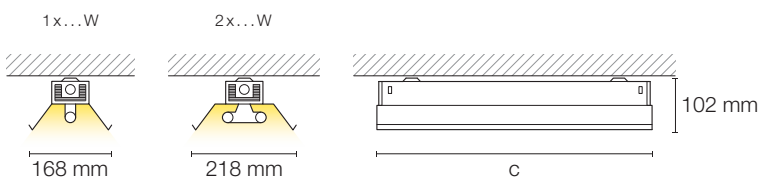

AIN REFLECTOR SURFACE

OPTIONS



EMERGENCY (EM)

ON/OFF

EM 1H T8 - 36W / 58W

REST MODE

9 VDC

COD

35.00.001.01.12



AIN IP40 REFLECTOR SURFACE



PT

- Luminária com IP40 para iluminação geral em interiores.
- Refletor simétrico disponível em alumínio branco ou brilhante.
- Corpo em chapa de aço com revestimento a epoxy-poliéster.
- Equipada com sistema de fecho que permite facilidade e rapidez de instalação.
- Disponível em versões para um ou dois tubos LED e lâmpadas fluorescentes T8 (não incluídos).

EN

- IP40 luminaire for general interior lighting.
- Symmetrical reflector available in white or mirrorbrite aluminium.
- Body made of steel sheet with epoxy-polyester powder coating.
- Quick-release reflector system enables an easy and quick installation.
- Available in versions for one or two T8 LED tubes and fluorescent lamps (not included).

QUICK INFO

GENERAL

Surface
IP40
650°C
Class I
Ta= -20°C +35°C

LIGHT SOURCE

LED Tubes (T8 G13)

ELECTRICAL SYSTEM

220-240V/50-60Hz
ON/OFF

FINISHING

RAL 9016 White

AIN IP40 REFLECTOR SURFACE

LED TUBES

WHITE REFLECTOR

c (mm)	Tubes	Power (W)	Output (lm)	Scheme A	Scheme C
1233	1	1x22 MAX	2475 ⁽¹⁾	33.71.000.01.01	33.71.000.01.24
1533	1	1x24 MAX	3663 ⁽²⁾	33.71.000.01.02	33.71.000.01.25
1233	2	2x22 MAX	4289 ⁽¹⁾	33.71.000.01.04	33.71.000.01.26
1533	2	2x24 MAX	6348 ⁽²⁾	33.71.000.01.05	33.71.000.01.27

ALUMINIUM REFLECTOR

c (mm)	Tubes	Power (W)	Output (lm)	Scheme A	Scheme C
1233	1	1x22 MAX	2272 ⁽¹⁾	33.71.000.01.07	33.71.000.01.28
1533	1	1x24 MAX	3363 ⁽²⁾	33.71.000.01.08	33.71.000.01.29
1233	2	2x22 MAX	4375 ⁽¹⁾	33.71.000.01.10	33.71.000.01.30
1533	2	2x24 MAX	6476 ⁽²⁾	33.71.000.01.11	33.71.000.01.31

DETAILS



WHITE REFLECTOR



ALUMINIUM REFLECTOR

LED TUBE (T8 G13) NOT INCLUDED

- ⁽¹⁾ PHILIPS G13 1200mm 15,5W 2500lm 840
- ⁽²⁾ PHILIPS G13 1500mm 23W 3700lm 840

More information about the LED Tube or available electrical schemes on page 180.

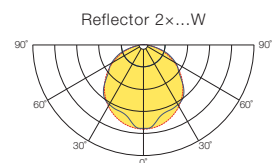
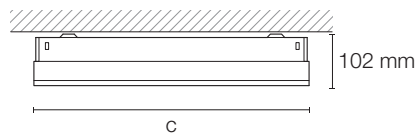
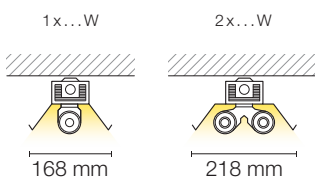
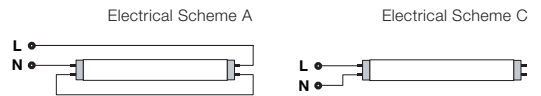

QUICK INFO

GENERAL

Surface
IP40
650°C
Class I
Ta= -20°C +35°C

LIGHT SOURCE

Fluorescent Lamps (T8 G13)

ELECTRICAL SYSTEM

220-240V/50-60Hz
ON/OFF

FINISHING

RAL 9016 White

DETAILS



WHITE REFLECTOR



ALUMINIUM REFLECTOR

AIN IP40 REFLECTOR SURFACE

T8 FLUORESCENT

WHITE REFLECTOR

c (mm)	Tubes	Power (W)	Output (lm)	ON/OFF
1233	1	1×36	2742 ⁽¹⁾	33.71.136.04.00
1533	1	1×58	4599 ⁽²⁾	33.71.158.04.04
1233	2	2×36	5366 ⁽¹⁾	33.71.236.04.02
1533	2	2×58	9000 ⁽²⁾	33.71.258.04.02

ALUMINIUM REFLECTOR

c (mm)	Tubes	Power (W)	Output (lm)	ON/OFF
1233	1	1×36	2650 ⁽¹⁾	33.71.136.04.01
1533	1	1×58	4446 ⁽²⁾	33.71.158.04.02
1233	2	2×36	5208 ⁽¹⁾	33.71.236.04.05
1533	2	2×58	8735 ⁽²⁾	33.71.258.04.07

FLUORESCENT LAMP (T8 G13) NOT INCLUDED

- ⁽¹⁾ OSRAM G13 1200mm 36W 3100lm
- ⁽²⁾ OSRAM G13 1500mm 58W 5200lm

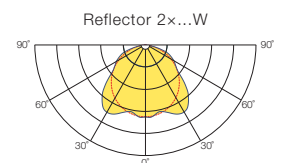
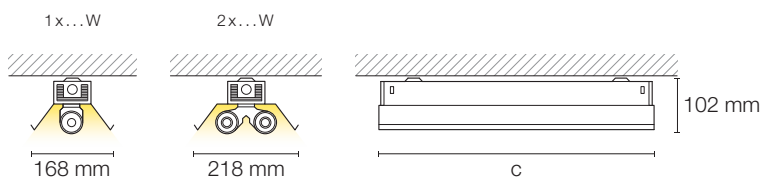

AIN IP40 REFLECTOR SURFACE

OPTIONS



EMERGENCY (EM)

ON/OFF

EM 1H T8 - 36W / 58W

REST MODE

9 VDC

COD

35.00.001.01.12





OTHER APPLICATIONS

VANDALPROOF

AAV
CORNER SURFACE



HOSPITAL

ASH
WALL



SCHOOL

BLACKBOARD
SUSPENDED / WALL



AAV

CORNER SURFACE

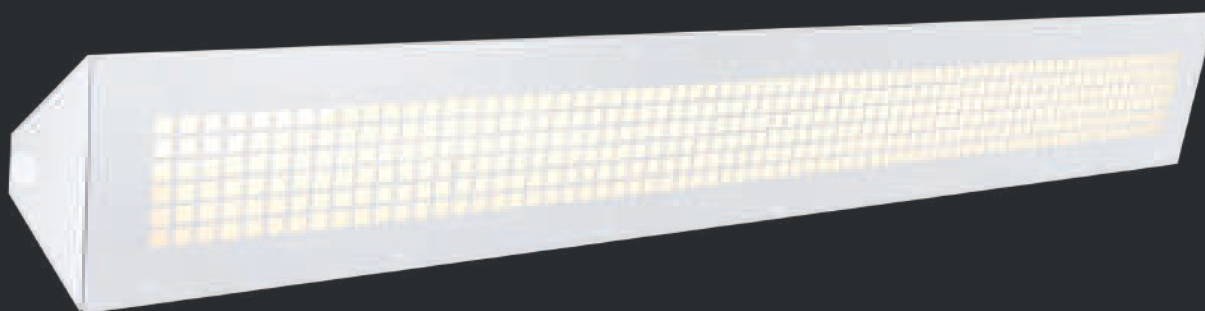

PT

- Luminária de canto para iluminação em acessos pedonais subterrâneos, escadas, corredores de acesso, parques de estacionamento, entre outros.
- Índice de proteção IP44 com resistência a impactos IK10.
- Difusor em Policarbonato Opal protegido por grelha de proteção em chapa de aço.
- Corpo em chapa de aço de formato triangular com ângulo de 45°.
- Disponível em vários comprimentos e potências de LED para se adequar às mais diversas aplicações.

EN

- Robust corner mounted luminaire ideal for lighting footpaths, stairs, car parks, porches and entrances, under canopies and arches.
- IP44 protection rating with IK10 impact resistance level.
- Opal Polycarbonate diffuser protected by a sheet steel protection grid.
- Triangular-shaped sheet steel body with 45° angle.
- Available in several lengths and LED powers to suit most applications.

QUICK INFO**GENERAL**

Corner Surface
IP44
IK10
850°C
Class I
Ta= -20°C +35°C

OPTIC

Opal Polycarbonate

LIGHT SOURCE

LED Modules

SPECIFICATIONS

Efficacy up to 176 lm/W
3000 K, 4000 K
CRI >80
Lifetime 72 000 H
L80/B10 @Tc=55°C

ELECTRICAL SYSTEM

220-240V/50-60Hz
ON/OFF, DALI

FINISHING

RAL 9016 White

AAV CORNER SURFACE**OPAL DIFFUSER**

Color Temp.	c (mm)	Output (lm)	System (W)	ON/OFF	DALI
3000 K	570	959	13	33.74.000.08.00	33.74.000.08.03
	1170	1917	25	33.74.000.08.01	33.74.000.08.04
	1470	2397	32	33.74.000.08.02	33.74.000.08.05
4000 K	570	1009	13	33.74.000.08.06	33.74.000.08.09
	1170	2018	25	33.74.000.08.07	33.74.000.08.10
	1470	2522	32	33.74.000.08.08	33.74.000.08.11

OPTIONS**EMERGENCY (EM) - SELF-TEST INTEGRATED**

ON/OFF	COD
EM 1H 3W	35.00.003.01.23
EM 3H 3W	35.00.003.01.24
DALI	COD
EM 1H 5,4W DALI	35.00.004.01.54
EM 3H 5,4W DALI	35.00.004.01.55

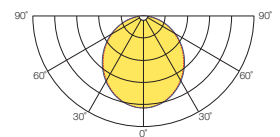
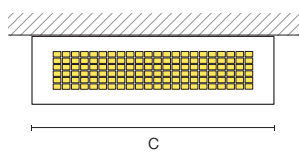
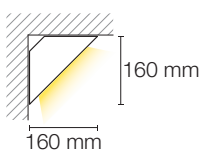
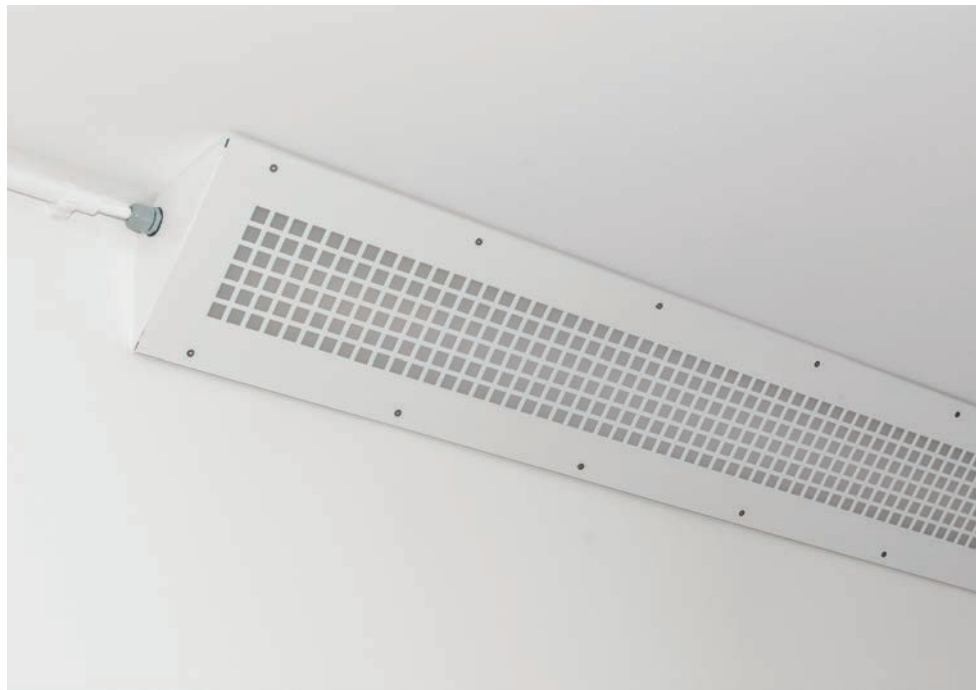

ASH WALL



PT

- Luminária para cabeceiras de cama em Centros de Saúde e Centros de Dia.
- Disponível em várias combinações de iluminação ambiente, luz de leitura e acessórios elétricos.
- A luminária standard inclui tomada Schuko, tomada de dados RJ-45 e comutador de cordão para controlo da iluminação.
- Possibilidade de incorporar outras tomadas de acordo com as necessidades.
- Superfícies lisas para maior facilidade de limpeza e desinfeção.
- Corpo em chapa de aço com revestimento a epoxy-poliéster.
- Em versões PCB LED e versões para tubos LED T8 (não incluídos).

EN

- Bed-head unit for Health Care Centres and Residential Homes.
- Available in several versions combining ambient lighting, reading light and electrical accessories.
- The standard luminaire includes Schuko socket, RJ-45 data socket and pull cord switch for lighting control.
- The luminaire can be customized with other sockets according to the customer requirements.
- Flat and smooth surfaces for ease of cleaning and disinfection.
- Body made of steel sheet with epoxy-polyester powder coating.
- Available in PCB LED versions and for use with T8 LED tubes (not included).

QUICK INFO

GENERAL

Wall
 IP30
 IK05
 650°C
 Class I
 Ta= -20°C +35°C

OPTIC

Opal PMMA - LED Modules
 Clear Prismatic PMMA - LED Tubes

LIGHT SOURCE

LED Modules
 LED Tubes (T8 G13)

SPECIFICATIONS

Efficacy up to 176 lm/W
 3000 K, 4000 K
 CRI >80
 Lifetime 72 000 H
 L80/B10 @Tc=65°C

ELECTRICAL SYSTEM

220-240V/50-60Hz
 ON/OFF

FINISHING

RAL 9016 White

OPTIONS

EMERGENCY

1 Hour, 3 Hours
 DALI 1 Hour, 3 Hours

ASH WALL

TYPE I - LIGHTING AND COMMAND DEVICES

OPAL DIFFUSER

LED MODULES

Color Temp.	c (mm)	Output (lm)	Indirect (W)	Direct (W)	FIG	COD
3000 K	1262	817	13	13	1	33.12.002.08.54
		1332	26	13	2	33.12.002.08.56
4000 K	1262	860	13	13	1	33.12.002.08.59
		1402	26	13	2	33.12.002.08.61

CLEAR PRISMATIC DIFFUSER

LED TUBES

c (mm)	Tubes	Indirect (W)	Direct (W)	Output (lm)	FIG	Scheme A	Scheme C
1262	2	1x10 MAX	1x10 MAX	405 ⁽¹⁾	1	33.12.000.01.02	33.12.000.01.07
	2	1x22 MAX	1x10 MAX	635 ⁽¹⁾⁽²⁾	2	33.12.000.01.04	33.12.000.01.09

FIG 1

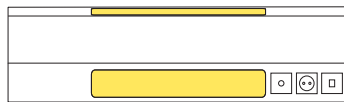
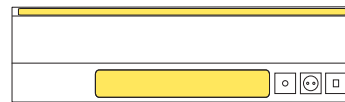
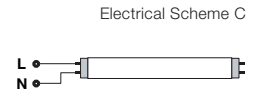
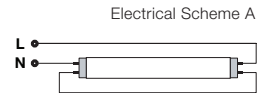

FIG 2



LED TUBE (T8 G13) NOT INCLUDED

- ⁽¹⁾ PHILIPS G13 600mm 8W 1050lm 840
 - ⁽²⁾ PHILIPS G13 1200mm 15,5W 2500lm 840
 More information about the LED Tube or available electrical schemes on page 180.



STANDARD COMMAND DEVICES

- 1 - PULL CORD SWITCH
- 2 - SCHUKO SOCKET OUTLET
- 3 - RJ-45 DATA SOCKET

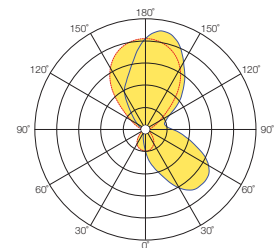
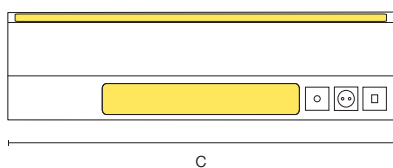
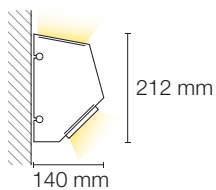

QUICK INFO

GENERAL

Wall
IP30
IK05
650°C
Class I
Ta= -20°C +35°C

OPTIC

Opal PMMA - LED Modules
Clear Prismatic PMMA - LED Tubes

LIGHT SOURCE

LED Modules
LED Tubes (T8 G13)

SPECIFICATIONS

Efficacy up to 176 lm/W
3000 K, 4000 K
CRI >80
Lifetime 72 000 H
L80/B10 @Tc=65°C

ELECTRICAL SYSTEM

220-240V/50-60Hz
ON/OFF

FINISHING

RAL 9016 White

ASH WALL

TYPE II - DIRECT LIGHT AND AMBIENT UP LIGHT

OPAL DIFFUSER

LED MODULES

Color Temp.	c (mm)	Output (lm)	Indirect (W)	Direct (W)	FIG	COD
3000 K	651	817	13	13	1	33.12.002.08.53
	1262	1332	26	13	2	33.12.002.08.55
		1635	26	26	3	33.12.002.08.57
4000 K	651	860	13	13	1	33.12.002.08.58
	1262	1402	26	13	2	33.12.002.08.60
		1720	26	26	3	33.12.002.08.62

CLEAR PRISMATIC DIFFUSER

LED TUBES

c (mm)	Tubes	Indirect (W)	Direct (W)	Output (lm)	FIG	Scheme A	Scheme C
651	2	1x10 MAX	1x10 MAX	405 ⁽¹⁾	1	33.12.000.01.01	33.12.000.01.06
1262	2	1x22 MAX	1x10 MAX	635 ⁽¹⁾⁽²⁾	2	33.12.000.01.03	33.12.000.01.08
	2	1x22 MAX	1x22 MAX	965 ⁽²⁾	3	33.12.000.01.05	33.12.000.01.10

- The TYPE II models don't include switches for lighting control system. Light must be managed by external switches.

OPTIONS

EMERGENCY

1 Hour, 3 Hours
DALI 1 Hour, 3 Hours

FIG 1

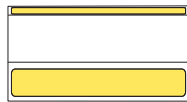

FIG 2

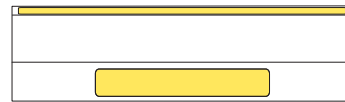
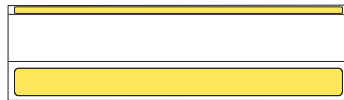
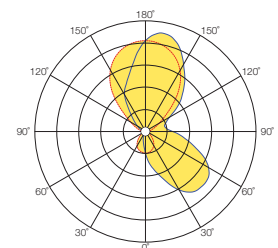
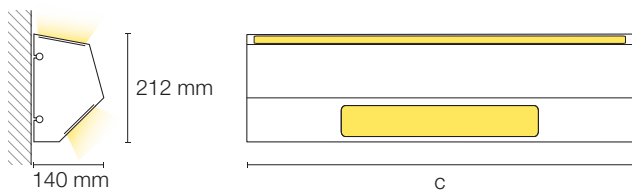
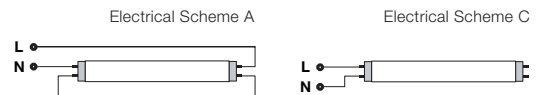

FIG 3



LED TUBE (T8 G13) NOT INCLUDED

- ⁽¹⁾ PHILIPS G13 600mm 8W 1050lm 840
 - ⁽²⁾ PHILIPS G13 1200mm 15,5W 2500lm 840
- More information about the LED Tube or available electrical schemes on page 180.



ASH WALL

OPTIONS



EMERGENCY (EM) - SELF-TEST INTEGRATED

ON/OFF	COD
EM 1H 3W	35.00.003.01.23
EM 3H 3W	35.00.003.01.24
DALI	COD
EM 1H 5,4W DALI	35.00.004.01.54
EM 3H 5,4W DALI	35.00.004.01.55

– Emergency only applied to LED Modules versions.

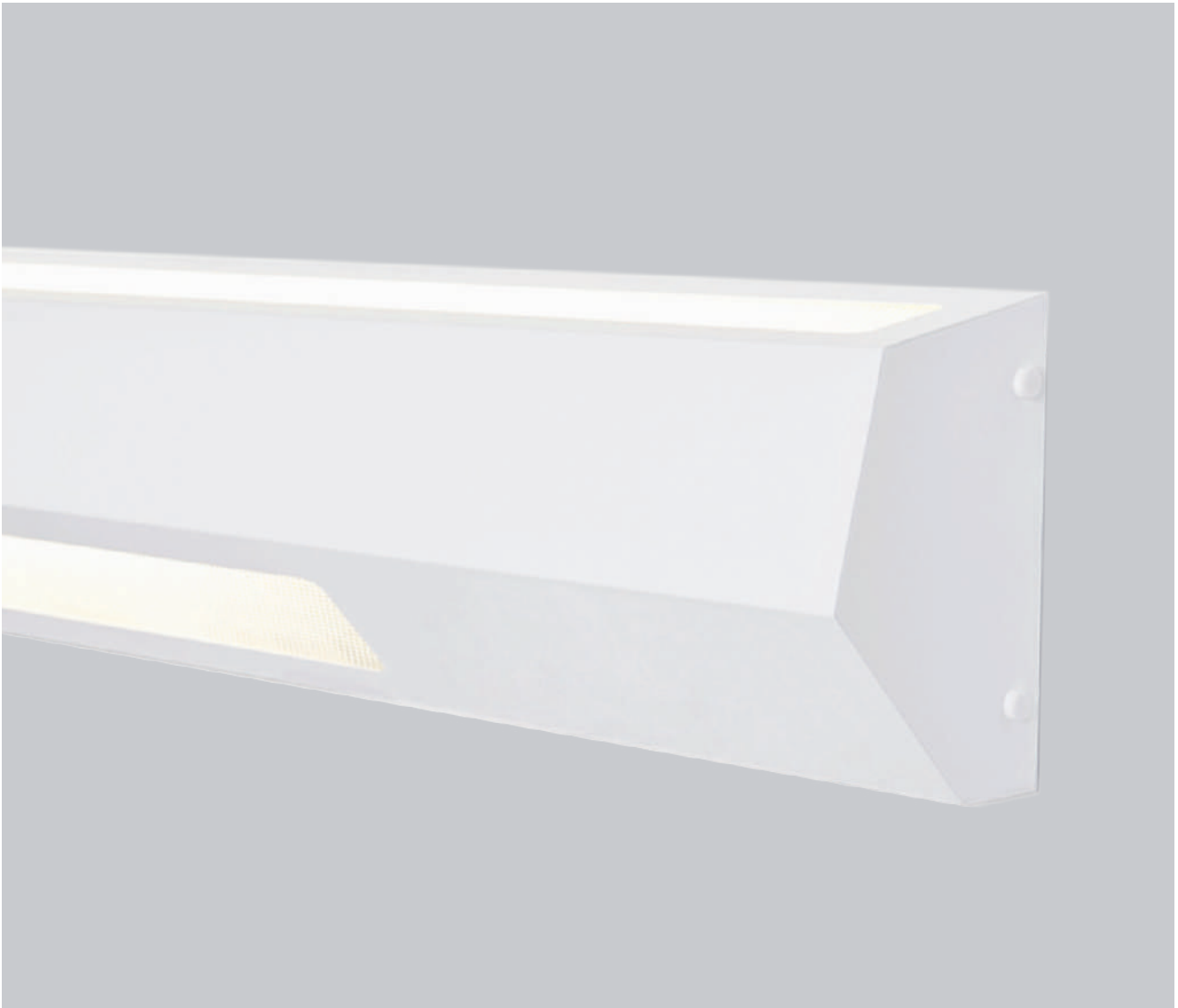

BLACKBOARD

SUSPENDED / WALL



PT

- Luminária com distribuição de luz assimétrica para iluminação de quadros escolares.
- Desenvolvida para iluminação de superfícies verticais, proporcionando máxima uniformidade e elevado conforto visual.
- Conjunto de acessórios de fixação no teto ou parede, permitindo a posição ideal para uma distribuição uniforme de luz sobre o quadro a iluminar.
- Corpo em chapa de aço com revestimento a epoxy-poliéster.
- Em versões PCB LED e versões para tubos LED T8 (não incluídos).

EN

- Luminaire with asymmetric light distribution for classroom blackboard lighting.
- Developed for lighting vertical surfaces, providing maximum uniformity and greater visual comfort.
- Ceiling or wall mounting set available in several lengths to enable the optimal position for an even distribution of light over the presentation area.
- Body made of steel sheet with epoxy-polyester powder coating.
- Available in PCB LED versions and for use with T8 LED tubes (not included).

SUSPENDED MOUNTING



WALL MOUNTING

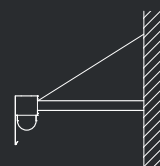

QUICK INFO

GENERAL

Suspended / Wall
 IP20
 IK05
 650°C - LED Modules
 860°C - LED Tubes
 Class I
 Ta= -20°C +35°C

OPTIC

Opal PMMA - LED Modules

LIGHT SOURCE

LED Modules
 LED Tubes (T8 G13)

SPECIFICATIONS

Efficacy up to 176 lm/W
 3000 K, 4000 K
 CRI >80
 Lifetime 72 000 H
 L80/B10 @Tc=55°C

ELECTRICAL SYSTEM

220-240V/50-60Hz
 ON/OFF

FINISHING

RAL 9003 Matt White
 RAL 9005 Matt Black

OPTIONS

EMERGENCY

1 Hour, 3 Hours
 DALI 1 Hour, 3 Hours

BLACKBOARD SUSPENDED / WALL

OPAL DIFFUSER

LED MODULES

Color Temp.	c (mm)	Output (lm)	System (W)	WHITE	BLACK
3000 K	1200	3057	25	33.70.000.08.01	33.70.000.08.03
	1500	3821	32	33.70.000.08.02	33.70.000.08.04
4000 K	1200	3217	25	33.70.000.08.05	33.70.000.08.07
	1500	4022	32	33.70.000.08.06	33.70.000.08.08

LED TUBES

c (mm)	Tubes	Power (W)	Output (lm)	Scheme	WHITE	BLACK
1250	1	1x22 MAX	1101 ⁽¹⁾	A	33.70.000.01.12	33.70.000.01.14
				C	33.70.000.01.58	33.70.000.01.60
1550	1	1x24 MAX	1629 ⁽²⁾	A	33.70.000.01.13	33.70.000.01.15
				C	33.70.000.01.59	33.70.000.01.61

LED TUBE (T8 G13) NOT INCLUDED

- ⁽¹⁾ PHILIPS G13 1200mm 15,5W 2500lm 840
 - ⁽²⁾ PHILIPS G13 1500mm 23W 3700lm 840
 More information about the LED Tube or available electrical schemes on page 180.

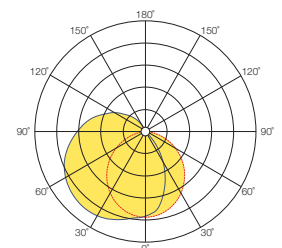
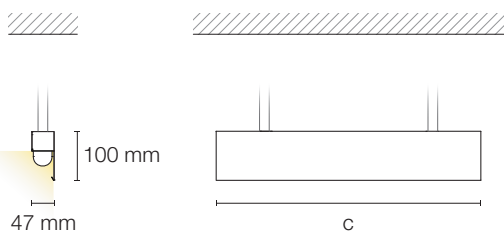
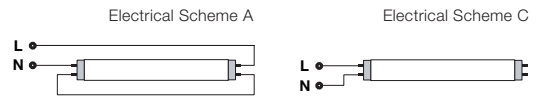

BLACKBOARD

SUSPENDED / WALL

COMPONENTS



SURFACE CEILING CUP (1pc)

TYPE

Matt White Ø62x36 mm

COD

35.70.000.01.19



RECESSED CEILING CUP (1pc)

TYPE

Matt White Ø80 mm

COD

35.70.000.01.20

SUSPENDED MOUNTING

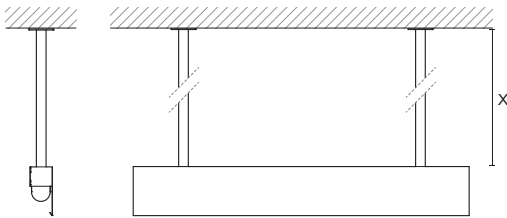

WALL MOUNTING

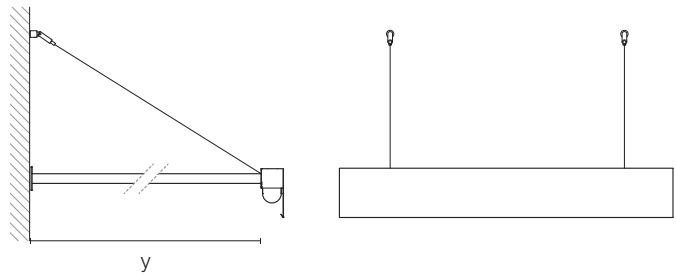

A SUSPENSION MOUNTING SYSTEM (2pcs)

TYPE

x (mm)

WHITE

BLACK

Suspension Mounting

500

35.70.000.01.07

35.70.000.01.09

Suspension Mounting

1000

35.70.000.01.08

35.70.000.01.10



B WALL MOUNTING SYSTEM (2pcs)

TYPE

y (mm)

COD

Wall Mounting + Stainless Steel Cable

400

35.70.000.01.15

Wall Mounting + Stainless Steel Cable

500

35.70.000.01.16

Wall Mounting + Stainless Steel Cable

600

35.70.000.01.17

Wall Mounting + Stainless Steel Cable

700

35.70.000.01.18

OPTIONS



EMERGENCY (EM) - SELF-TEST INTEGRATED

ON/OFF

COD

EM 1H 3W

35.00.003.01.23

EM 3H 3W

35.00.003.01.24

DALI

COD

EM 1H 5,4W DALI

35.00.004.01.54

EM 3H 5,4W DALI

35.00.004.01.55

– Emergency only applied to LED Modules versions.





LED STRIPS

LED FLEX IP20
SURFACE



LED FLEX IP65
SURFACE

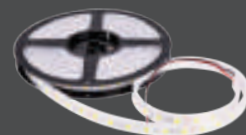

DRIVERS
CLASS II

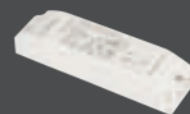

PROFILES
SURFACE
CORNER
RECESSED
TRIMLESS
EDGE TRIMLESS

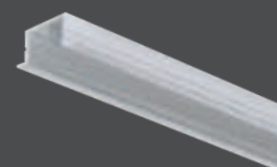

LED FLEX IP20



PT

- Opções para decoração de interiores em ambientes residenciais ou profissionais.
- Driver externo de tensão constante e classe de proteção II (não incluído).
- Disponível em bobinas de 10 metros de fita flexível contínua.
- Incorpora fita adesiva 3M para uma simples e rápida aplicação.
- Fita flexível LED dimável alimentada a 24VDC (tensão reduzida).

EN

- Options for interior decoration, for both residential and office use.
- External class II constant voltage power supply (not included).
- Available in 10 metres continuous flexible strip coils.
- Fitted with 3M adhesive tape for easy and quick application.
- Dimmable flexible LED input voltage: 24V DC (reduced tension).

RECOMMENDED PROFILES KNOW MORE ABOUT PROFILES ON PAGE 172 AND 174 ►

LED FLEX

		NANO-S8 SURFACE	NANO-S17 SURFACE	NANO CORNER SURFACE	ERGOS-L SURFACE	NANO-R8 RECESSED	NANO-R14 RECESSED	NANO-T14 TRIMLESS	NANO EDGE TRIMLESS
	IP20								
	POWER								
	5 W/m	✓	✓	✓	✓	✓	✓	✓	✓
	8 W/m	✓	✓	✓	✓	✓	✓	✓	✓
	12 W/m	✓	✓	✓	✓	✓	✓	✓	✓
	22 W/m	✗	✓	✓	✓	✗	✓	✓	✓

QUICK INFO

GENERAL

With 3M Adhesive Tape
IP20
Ta= -25°C +45°C

LED

Efficacy up to 135 lm/W
2700 K, 3000 K, 4000 K
CRI >80
Beam Angle 120°
Lifetime 30 000 H
L80/B10 @TC=55°C
24 VDC

ELECTRICAL SYSTEM

220-240V/50-60Hz
ON/OFF, DALI

LED FLEX

IP20

Color Temp.	Power (W/m)	Output (lm/m)	LED/m	b (mm)	Cut Gap (mm)	COD
2700 K	5	612	60	8	100	35.00.005.01.11
	8	1027	120	8	50	35.00.005.01.74
	12 *	1421	120	8	50	35.00.005.01.12
	22 *	2257	120	12	50	35.00.005.01.13
3000 K	5	621	60	8	100	35.00.005.01.14
	8	1047	120	8	50	35.00.005.01.75
	12 *	1445	120	8	50	35.00.005.01.15
	22 *	2274	120	12	50	35.00.005.01.16
4000 K	5	642	60	8	100	35.00.005.01.17
	8	1082	120	8	50	35.00.005.01.76
	12 *	1495	120	8	50	35.00.005.01.18
	22 *	2332	120	12	50	35.00.005.01.19

– * Heatsink profile required for effective thermal dissipation.

COMPONENTS



CLASS II

DRIVERS - EXTERNAL

TYPE	DIMENSION	COD	
Power Supply 30W IP20	26,5×40×145 mm	35.41.00.000117	
ON/OFF	Power Supply 60W IP20	31×40×200 mm	35.00.004.01.89
	Power Supply 120W IP20	31×40×260 mm	35.41.00.000118
DALI	Power Supply 35W IP20	30,2×43×195 mm	35.00.004.01.92
	Power Supply 60W IP20	30,2×43×225 mm	35.00.004.01.93
	Power Supply 100W IP20	29,8×43×295 mm	35.00.004.01.94
	Power Supply 150W IP20	29,8×43×325 mm	35.00.004.01.95

– External Driver to be housed nearby.

OPTIONS



CLASS II

EMERGENCY (EM)

ON/OFF	REST MODE	COD
EM 1H MAX 30W	9 Vdc	35.00.005.01.36
EM 3H MAX 30W	9 Vdc	35.00.005.01.37

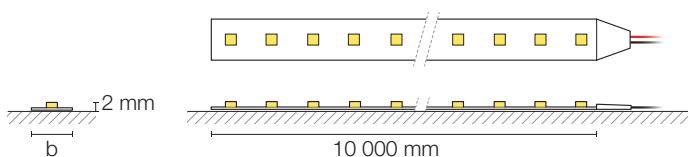

LED FLEX IP65



PT

- Apropriada para aplicação em interiores, em instalações onde não exista exposição solar.
- Driver externo de tensão constante e classe de proteção II (não incluído).
- Disponível em bobinas de 5 metros de fita flexível contínua.
- Incorpora fita adesiva 3M para uma simples e rápida aplicação.
- Fita flexível LED dimável alimentada a 24VDC (tensão reduzida).
- Índice de proteção IP65 contra o pó e vapor de água.

EN

- Suitable for interior design where there is no direct sun exposure.
- External class II constant voltage Driver (not included).
- Available in 5 metres continuous flexible strip coils.
- Fitted with 3M adhesive tape for easy and quick application.
- Dimmable flexible LED input voltage: 24V DC (reduced tension).
- IP65 protection rating against dust and steam.

RECOMMENDED PROFILES KNOW MORE ABOUT PROFILES ON PAGE 172 AND 174 ►

LED FLEX

		NANO-S8 SURFACE	NANO-S17 SURFACE	NANO CORNER SURFACE	ERGOS-L SURFACE	NANO-R8 RECESSED	NANO-R14 RECESSED	NANO-T14 TRIMLESS	NANO EDGE TRIMLESS
	IP65								
	POWER								
	5 W/m	×	✓	✓	✓	×	✓	✓	✓
	8 W/m	×	✓	✓	✓	×	✓	✓	✓
	12 W/m	×	✓	✓	✓	×	✓	✓	✓
	22 W/m	×	×	×	×	×	×	✓	✓

QUICK INFO

GENERAL

With 3M Adhesive Tape
IP65
Ta= -25°C +45°C

LED

Efficacy up to 129 lm/W
2700 K, 3000 K, 4000 K
CRI >80
Beam Angle 120°
Lifetime 30 000 H
L80/B10 @TC=55°C
24 VDC

ELECTRICAL SYSTEM

220-240V/50-60Hz
ON/OFF, DALI

LED FLEX

IP65

Color Temp.	Power (W/m)	Output (lm/m)	LED/m	b (mm)	Cut Gap (mm)	COD
2700 K	5	581	60	12	100	35.00.005.01.20
	8	976	120	12	50	35.00.005.01.77
	12 *	1332	120	12	50	35.00.005.01.21
	22 *	2097	120	16	50	35.00.005.01.22
3000 K	5	590	60	12	100	35.00.005.01.23
	8	997	120	12	50	35.00.005.01.78
	12 *	1356	120	12	50	35.00.005.01.24
	22 *	2120	120	16	50	35.00.005.01.25
4000 K	5	609	60	12	100	35.00.005.01.26
	8	1033	120	12	50	35.00.005.01.79
	12 *	1392	120	12	50	35.00.005.01.27
	22 *	2202	120	16	50	35.00.005.01.28

– * Heatsink profile required for effective thermal dissipation.

ACCESSORIES



END CAPS (1pc)

TYPE	FIG	COD
End Cap with holes 5W / 8W / 12W	1	35.00.005.01.30
End Cap 5W / 8W / 12W	2	35.00.005.01.29
End Cap with holes 22W	1	35.00.005.01.32
End Cap 22W	2	35.00.005.01.31



SILICONE SEALANT TUBE (1pc)

TYPE	FIG	END CAP SEALANTS	COD
Silicone Sealant Tube 300 ml	1	Up to 300 applications.	35.00.005.01.35
Silicone Sealant Tube 40 ml	2	Up to 40 applications.	35.00.005.01.63



MOUNTING HOLDER (1pc) - WHEN PROFILES ARE NOT USED

TYPE	DIMENSION	COD
Mounting Holder 5W / 8W / 12W	5×6×26 mm	35.00.005.01.33
Mounting Holder 22W	5×6×30 mm	35.00.005.01.34

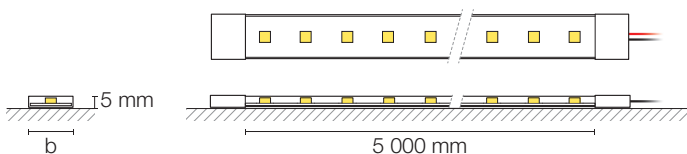
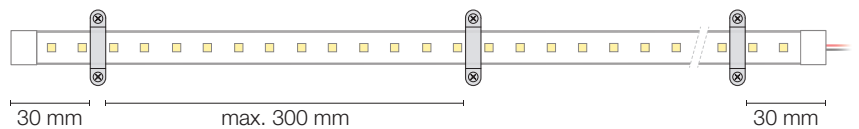

DRIVERS

RANGE

COMPONENTS

DRIVERS - EXTERNAL



CLASS II

IP20

ON/OFF	DIMENSION	COD
Power Supply 30W IP20	26,5×40×145 mm	35.41.00.000117
Power Supply 60W IP20	31×40×200 mm	35.00.004.01.89
Power Supply 120W IP20	31×40×260 mm	35.41.00.000118
DALI	DIMENSION	COD
Power Supply 35W IP20	30,2×43×195 mm	35.00.004.01.92
Power Supply 60W IP20	30,2×43×225 mm	35.00.004.01.93
Power Supply 100W IP20	29,8×43×295 mm	35.00.004.01.94
Power Supply 150W IP20	29,8×43×325 mm	35.00.004.01.95

– External Driver to be housed nearby.



CLASS II

IP66

ON/OFF	DIMENSION	COD
Power Supply 20W IP66	25×43×178 mm	35.41.00.000119
Power Supply 40W IP66	26×43×208 mm	35.41.00.000120
Power Supply 60W IP66	26×43×208 mm	35.41.00.000121
Power Supply 100W IP66	34×50×240 mm	35.41.00.000122
Power Supply 130W IP66	37×63×220 mm	35.41.00.000123
DALI	DIMENSION	COD
Power Supply 100W IP66	37×69×237 mm	35.41.00.000124
Power Supply 210W IP66	37×69×330 mm	35.41.00.000125

– External Driver to be housed nearby.

OPTIONS



CLASS II

EMERGENCY (EM)

ON/OFF	REST MODE	COD
EM 1H MAX 30W	9 VDC	35.00.005.01.36
EM 3H MAX 30W	9 VDC	35.00.005.01.37

RECOMMENDED LED FLEX KNOW MORE ABOUT **LED FLEX** TO BE USED WITH THIS **DRIVERS** ON PAGE **166** AND **168** ►

RECOMMENDED PROFILES KNOW MORE ABOUT **PROFILES** ON PAGE **172** AND **174** ►



PROFILES

SURFACE

NANO-S8

SURFACE

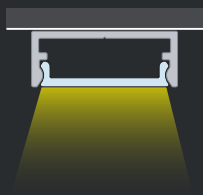

NANO-S17

SURFACE

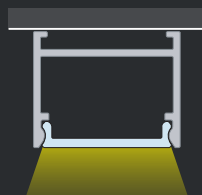

NANO CORNER

SURFACE



ERGOS-L

SURFACE

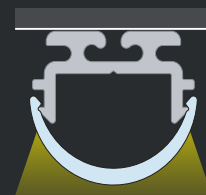

PT

- Perfis elegantes e compactos para iluminação de mobiliário e sancas.
- Adequado para aplicação saliente ou canto, no teto ou na parede.
- Sistema de clipagem incluído que permite instalação rápida com apenas um clique e sem parafusos visíveis.
- Drivers externos de tensão constante e classe de proteção II.
- Difusores em PC opal e corpos em perfil de alumínio anodizado mate.

EN

- Slender and compact profiles for furniture and cove lighting.
- Suitable for ceiling, wall and corner surface mounting.
- Quick clamping system included for tool-free installation with a simple click and without visible screws.
- External class II constant voltage drivers.
- Opal PC diffuser and matt anodized aluminium profiles body.

NANO-S8 SURFACE

TYPE		DIMENSIONS	COD
A Profile	White	c = 2030 mm	35.41.15.000956
		c = 3030 mm	35.41.15.000957
	Anodized	c = 2030 mm	35.41.15.000958
		c = 3030 mm	35.41.15.000959
B Diffuser		c = 2030 mm	35.41.15.000911
		c = 3030 mm	35.41.15.000912
C End Cap	White (2pc)	21×17×9 mm	35.41.15.000960
	Grey (2pc)	21×17×9 mm	35.41.15.000961

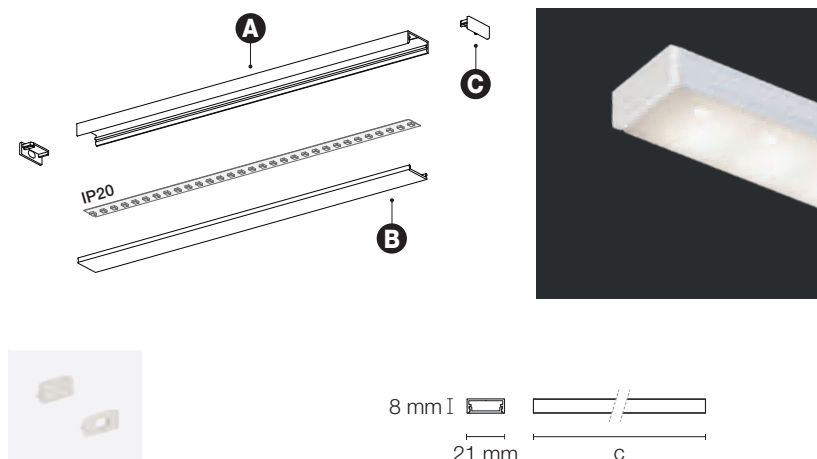

NANO-S17 SURFACE

TYPE		DIMENSIONS	COD
A Profile	White	c = 2030 mm	35.41.15.000880
		c = 3030 mm	35.41.15.000881
	Anodized	c = 2030 mm	35.41.15.000882
		c = 3030 mm	35.41.15.000883
B Diffuser		c = 2030 mm	35.41.15.000911
		c = 3030 mm	35.41.15.000912
C End Cap White (2pc)		21×17×9 mm	35.41.15.000884
C End Cap Grey (2pc)		21×17×9 mm	35.41.15.000885
D Fixing Clip (2pc) *		27×19×3 mm	35.41.15.000886
D Fixing Clip (3pc) *		27×19×3 mm	35.41.15.000916

* Apply 2 to $c \leq 1000$ mm; 3 to $1000 < c < 2000$ mm; 4 to $2000 \leq c \leq 3000$ mm.

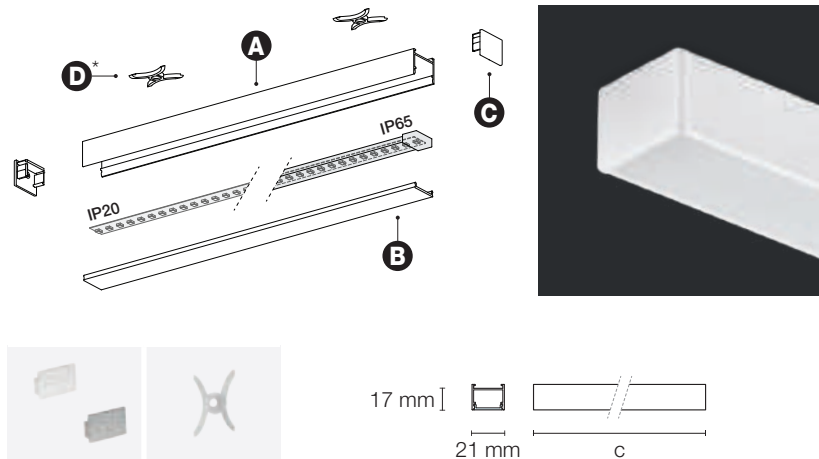

NANO CORNER SURFACE

TYPE		DIMENSIONS	COD
A Profile	White	c = 2030 mm	35.41.15.000866
		c = 3030 mm	35.41.15.000867
	Anodized	c = 2030 mm	35.41.15.000868
		c = 3030 mm	35.41.15.000869
B Diffuser		c = 2030 mm	35.41.15.000911
		c = 3030 mm	35.41.15.000912
C End Cap White (2pc)		25×25×12 mm	35.41.15.000870
C End Cap Grey (2pc)		25×25×12 mm	35.41.15.000871
D Fixing Clip (2pc) *		27×25×10 mm	35.41.15.000872
D Fixing Clip (3pc) *		27×25×10 mm	35.41.15.000913

* Apply 2 to $c \leq 1000$ mm; 3 to $1000 < c < 2000$ mm; 4 to $2000 \leq c \leq 3000$ mm.

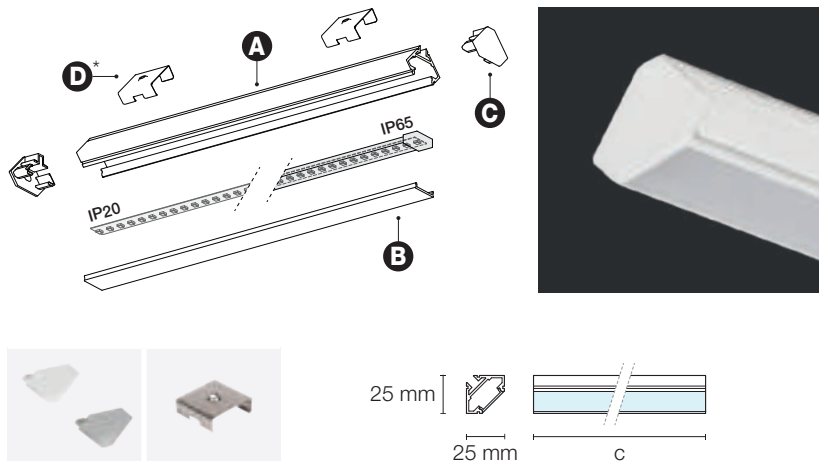

ERGOS-L SURFACE

TYPE		DIMENSIONS	COD
A Profile Anodized		c = 2030 mm	35.41.15.000971
		c = 3030 mm	35.41.15.000972
B Diffuser		c = 2030 mm	35.41.15.000973
		c = 3030 mm	35.41.15.000974
C End Cap (1pc)		16×16 mm	35.41.15.000848
C End Cap + Hole (1pc)		16×16 mm	35.41.15.000859
D Fixing Clamp (1pc) ①		10×8×16 mm	35.41.15.000849
D Rotating Clamp (1pc) ②		20×16×8 mm	35.41.15.000850

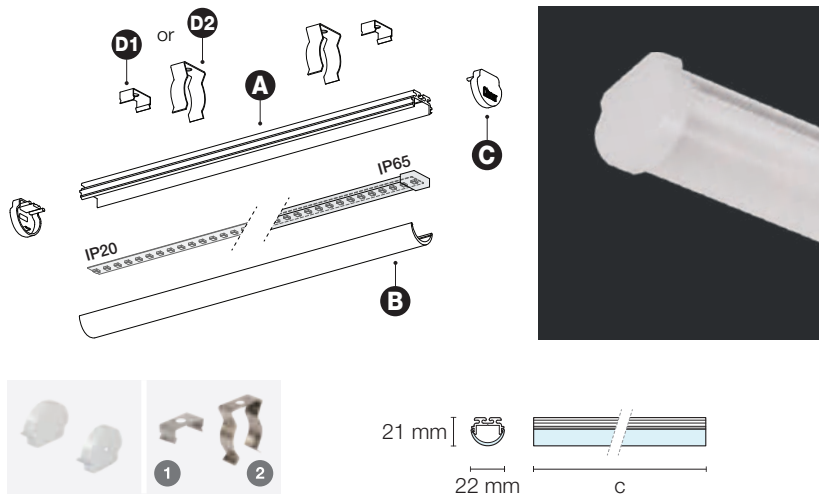

PROFILES SUPPLIED WITHOUT LED TAPE

KNOW MORE ABOUT **LED FLEX** TO BE USED ON THIS **PROFILES** ON PAGE 166 AND 168 ►

PROFILES

RECESSED / TRIMLESS

NANO-R8
RECESSED

NANO-R14
RECESSED

NANO-T14
TRIMLESS

NANO EDGE
TRIMLESS

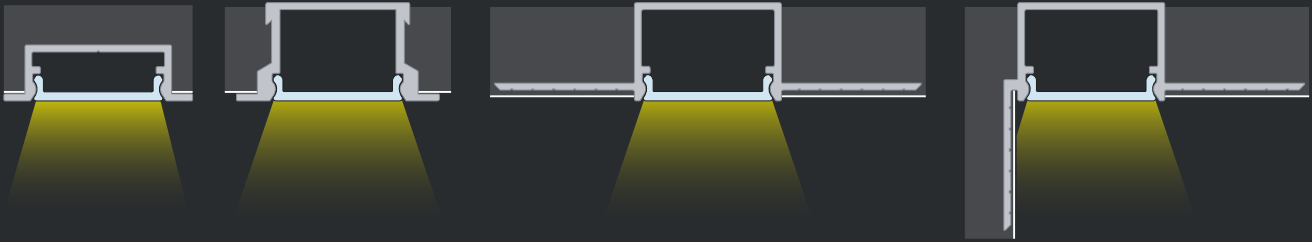

PT

- Perfis elegantes e compactos para iluminação de mobiliário e sancas.
- Adequado para aplicação encastrada no teto ou na parede.
- Sistema de clipagem incluído que permite instalação rápida com apenas um clique e sem parafusos visíveis.
- Drivers externos de tensão constante e classe de proteção II.
- Difusores em policarbonato opal e corpos em perfil de alumínio anodizado mate.

EN

- Slender and compact profiles for furniture and cove lighting.
- Suitable for ceiling or wall recessed mounting.
- Quick clamping system included for tool-free installation with a simple click and without visible screws.
- External class II constant voltage drivers.
- Opal polycarbonate diffuser and matt anodized aluminium profiles body.

NANO-R8 RECESSED

	TYPE	DIMENSIONS	COD
A	Profile	White	c = 2030 mm 35.41.15.000950
			c = 3030 mm 35.41.15.000951
	Anodized		c = 2030 mm 35.41.15.000952
			c = 3030 mm 35.41.15.000953
B	Diffuser	c = 2030 mm	35.41.15.000911
		c = 3030 mm	35.41.15.000912
C	End Cap White (2pc)	21×17×9 mm	35.41.15.000954
	End Cap Grey (2pc)	21×17×9 mm	35.41.15.000955

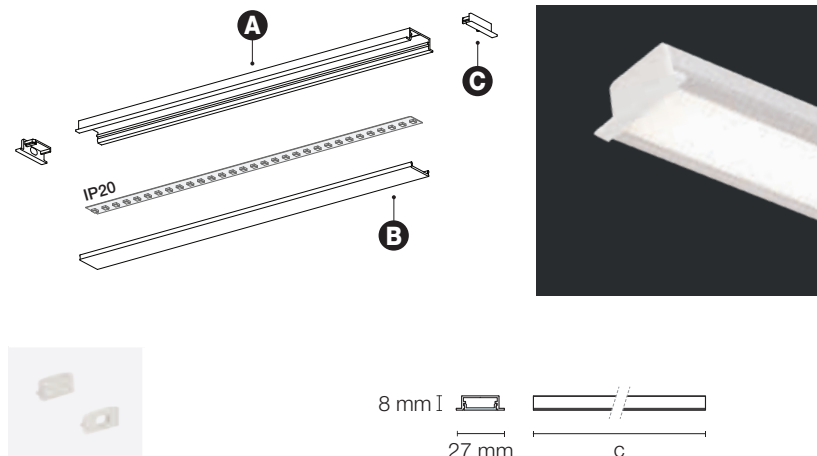

NANO-R14 RECESSED

TYPE		DIMENSIONS	COD
A Profile	White	c = 2030 mm	35.41.15.000873
		c = 3030 mm	35.41.15.000875
	Anodized	c = 2030 mm	35.41.15.000914
		c = 3030 mm	35.41.15.000876
B Diffuser		c = 2030 mm	35.41.15.000911
		c = 3030 mm	35.41.15.000912
C End Cap White (2pc)		21×17×9 mm	35.41.15.000917
	End Cap Grey (2pc)	21×17×9 mm	35.41.15.000878
D Fixing Clip (2pc) *		27×19×3 mm	35.41.15.000918
	Fixing Clip (3pc) *	27×19×3 mm	35.41.15.000915

* Apply 2 to c ≤ 1000mm; 3 to 1000 < c < 2000mm; 4 to 2000 ≤ c ≤ 3000mm.

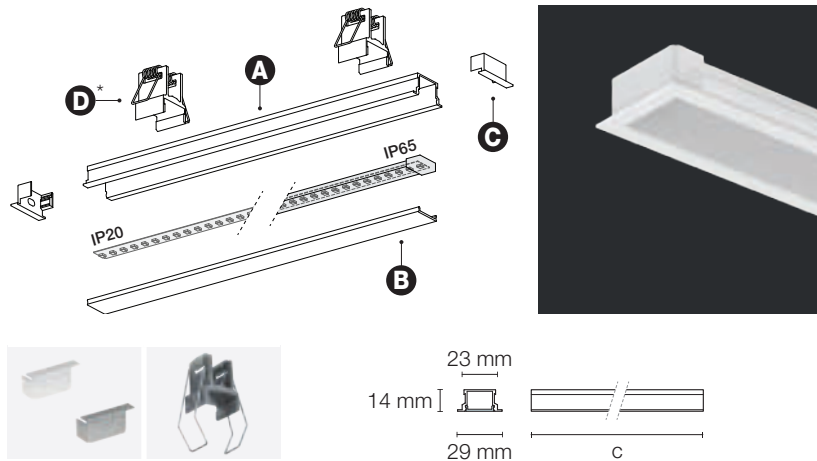

NANO-T14 TRIMLESS

TYPE		DIMENSIONS	COD
A Profile	White	c = 2030 mm	35.41.15.000887
		c = 3030 mm	35.41.15.000888
B Diffuser		c = 2030 mm	35.41.15.000911
		c = 3030 mm	35.41.15.000912
C End Cap White (2pc)		25×25×12 mm	35.41.15.000889
D Trimless Installation Cover		c = 2050 mm	35.41.15.000970

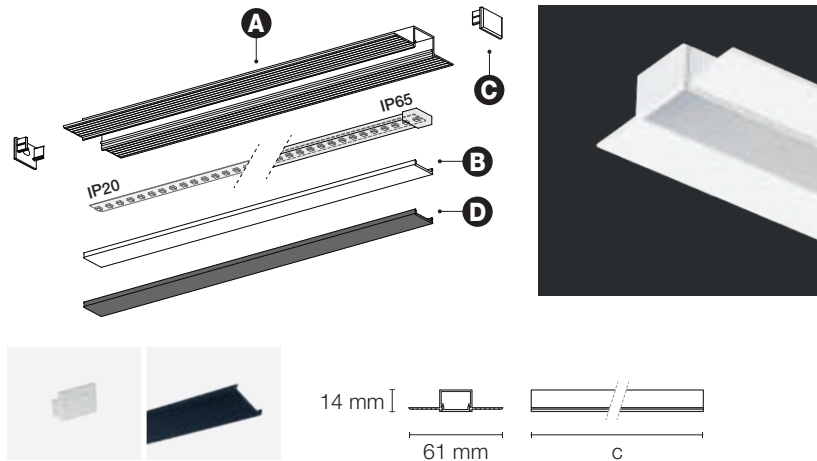

NANO EDGE TRIMLESS

TYPE		DIMENSIONS	COD
A Profile	White	c = 2030 mm	35.41.15.000890
		c = 3030 mm	35.41.15.000891
B Diffuser		c = 2030 mm	35.41.15.000911
		c = 3030 mm	35.41.15.000912
C End Cap White (2pc)		25×25×12 mm	35.41.15.000889
D Trimless Installation Cover		c = 2050 mm	35.41.15.000970

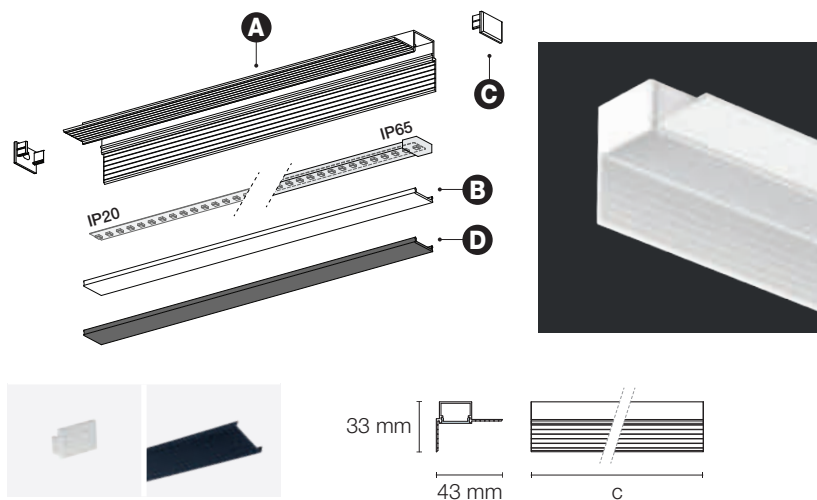

PROFILES SUPPLIED WITHOUT LED TAPE

KNOW MORE ABOUT **LED FLEX** TO BE USED ON THIS **PROFILES** ON PAGE 166 AND 168 ►



ADDITIONAL INFORMATION

TECHNICAL INFO

pag. 178

LIGHT SOURCES

pag. 180



A-Z INDEX

pag. 181



TECHNICAL INFORMATION

PT SÍMBOLOGIA E ABREVIATURAS EN SYMBOLS AND ABBREVIATIONS

EN 60 598	<p>Todos os produtos são projetados e produzidos de acordo com as normas europeias da série EN 60 598.</p> <p>Climar Lighting products are designed and produced within the European Standards of the EN 60598 series.</p>
ROHS 2	<p>Diretiva 2011/65/UE do Parlamento Europeu e do Conselho de 8 de junho de 2011 e Diretiva Delegada (UE) 2015/863 da Comissão de 31 de março de 2015, relativa à restrição do uso de determinadas substâncias perigosas em equipamentos elétricos e eletrónicos.</p> <p>Directive 2011/65/EU of the European Parliament and of the Council of 8 June 2011 and Delegated Directive (UE) 2015/863 of Committee of 31 March 2015, on the restriction of the use of certain hazardous substances in electrical and electronic equipment.</p>
CE	<p>Todos os produtos cumprem os requisitos das diretivas europeias aplicáveis, possuindo marcação CE.</p> <p>All products meet the requirements of the relevant European directives and therefore carry the CE label.</p>
IPXX	<p>O prefixo IP seguido de dois algarismos é um sistema de codificação que indica a “resistência” da luminária à penetração de poeiras, corpos sólidos e líquidos de acordo com a norma EN 60598. O primeiro algarismo identifica a proteção contra a penetração de corpos sólidos e poeira, e o segundo à entrada de água e humidade.</p> <p>The IP (Ingress Protection) is a coding system that indicates the luminaire's stability in withstanding the penetration of dust, solid bodies and liquids in accordance with EN 60598. The first IP code refers to the protection against the penetration of solid bodies and dust, while the second code refers to the ingress of water and moisture.</p>
IKXX	<p>Grau de resistência dos invólucros das luminárias a impactos mecânicos externos, definidos pela norma EN 62262.</p> <p>Coding system that shows the level of protection provided by enclosures for electrical equipment against external mechanical impacts, in accordance with EN 62262 standards.</p>
650° C 750° C 850° C 960° C	<p>Resistência ao ensaio do fio incandescente de acordo com a norma EN 60598-1.</p> <p>Glow Wire test in accordance with EN 60598-1.</p>
	<p>Classe I identifica luminárias com isolamento principal e proteção por ligação à terra prevista nas partes metálicas acessíveis.</p> <p>Safety Class I designates luminaires where all the exposed metal parts are connected to one another and to the protective earth conductor.</p>
	<p>Classe II identifica luminárias com isolamento principal e isolamento suplementar, mas sem meio de proteção por ligação à terra.</p> <p>Safety Class II designates luminaires that are insulated in such a way that there are no exposed metal parts that can carry current.</p>
	<p>Classe III identifica luminárias previstas para alimentação em muita baixa tensão de segurança.</p> <p>Safety Class III designates luminaires operating on extra-low safety voltage.</p>
Ta= ...°C	<p>O símbolo Ta = ...°C indica o intervalo de temperatura ambiente, medido em graus Celsius (°C), na qual a luminária está preparada para funcionar.</p> <p>The symbol Ta = ...°C indicates the ambient temperature range, measured in degrees Celsius (°C) at which a luminaire is allowed to be operated.</p>
Beam Angle (°)	<p>Refere-se ao ângulo de abertura do feixe de luz da luminária.</p> <p>Refers to the light beam angle of the luminaire.</p>

Output (lm)	Os lumens (lm) indicados referem-se ao fluxo luminoso total emitido pela luminária. Este valor está sujeito a uma tolerância de +/- 10%. Lumen (lm) output values refers to the total luminous flux which is emitted by the luminaire. This information is subject to a tolerance of +/- 10%.
System (W)	A potência do sistema indicada em Watts (W), refere-se ao consumo total da luminária após a sua estabilização térmica, incluindo todos os componentes instalados, módulo de LED e Driver. Os valores indicados são nominais, estando sujeitos a uma tolerância de +/- 10%. Indicated Watt (W) values refers to the luminaire total power consumption after thermal stabilisation including all the installed components, LED module and Driver. The values in this catalogue are rated values, which is subject to a tolerance of +/- 10%.
Power (W)	A potência indicada em Watts (W) refere-se: – Ao consumo do LED, excluindo Driver (Driver externo fornecido separadamente). – À potência máxima admissível da lâmpada a usar na luminária (luminárias fornecidas sem lâmpada). Estes valores estão sujeitos a uma tolerância de +/- 10%. Indicated Watt (W) values refers to: – The power consumption of the LED module, excluding Driver (remote Driver supplied separately). – The maximum lamp wattages permissible for operation (luminaires supplied without light source). These values are subject to a tolerance of +/- 10%.

PT CARACTERÍSTICAS DO LED EN LED FEATURES

XX00 K	O termo Temperatura de Cor em Kelvin (K) é usado para definir a cor da luz branca. The term "colour temperature" is used for the light colour of white light and is expressed in Kelvin (K).
CRI >XX	O Índice de Restituição de Cor (CRI) representa a capacidade da fonte de luz em conseguir reproduzir fielmente as cores dos objetos iluminados, por comparação com uma fonte de luz natural. Um CRI acima de 80 é bom, acima de 90 é muito bom. The colour rendering index (CRI) stands for the ability of a light source to reproduce colours faithfully in comparison with an ideal or natural light source. A CRI above 80 is good, above 90 is very good.
lm/W	A eficiência luminosa da luminária é o rácio entre o fluxo luminoso emitido e a potência consumida pela luminária. Este valor é expresso em lumen por watt (lm/W). The luminaire luminous efficiency is the quotient of the emitted luminous flux and the electric power consumed by the luminaire. The value is expressed in lumen per watt (lm/W).
Lifetime	O tempo de vida útil do módulo LED é expresso em horas e depende da temperatura máxima permitida no tc-point (@Tc). Information about LED module lifetime is expressed in hours and depends on the maximum permissible temperature which may occur at the tc-point (@Tc).
LXX/BXX	O valor L representa a percentagem do fluxo luminoso inicial que o LED continua a emitir após o número especificado de horas de funcionamento. O valor B indica a percentagem de LEDs que poderão estar abaixo do valor L específico. The L value represents the percentage of original luminous flux that the LED continues to achieve after the specified number of operating hours. The B value indicates the percentage of LEDs which are below the specific L value.

PT SISTEMAS ELÉTRICOS EN ELECTRICAL SYSTEMS

ON/OFF	Fonte de alimentação ON/OFF (sem regulação do fluxo). ON/OFF Power Supply (non dimmable).
---------------	--



DALI (Digital Addressable Lighting Interface) é um protocolo universal para gestão de sistemas de iluminação.
The Digital Addressable Lighting Interface (DALI) is a standard protocol for lighting management system.

LIGHT SOURCES

COMPONENTS AND SCHEMES

PT **LÂMPADAS DISPONÍVEIS** EN **AVAILABLE LAMPS**



LED TUBES T8 (G13)

TYPE	DIMENSION	SCHEME	COD
LUXTEK Tubular 10W T8 865 900lm *	600 mm	A	61.24.03.010.13
LUXTEK Tubular 14W T8 865 1200lm *	900 mm	A	61.24.03.014.04
LUXTEK Tubular 22W T8 865 2000lm *	1200 mm	A	61.24.03.022.00
LUXTEK Tubular 24W T8 865 2300lm *	1500 mm	A	61.24.03.024.02

* Lâmpadas LED não dimáveis. | LED Tubes not dimmable.



LED TUBES T9 (G10q)

TYPE	DIMENSION	SCHEME	COD
LUXTEK Circular 14W T9 865 1500lm *	Ø215 mm	E	61.24.03.014.08
LUXTEK Circular 18W T9 865 2000lm *	Ø300 mm	E	61.24.03.018.02

* Lâmpadas LED não dimáveis. | LED Tubes not dimmable.

PT **ESQUEMAS ELÉTRICOS** EN **ELECTRICAL SCHEMES**

LED TUBE T8 TUBULAR

Caso nenhum dos esquemas elétricos apresentados anteriormente seja indicado, selecione o esquema para a sua luminária LED TUBE Tubular (T8).

If none of the wiring diagrams shown previously is indicated, select the scheme for your Tubular LED TUBE luminaire (T8).

Esquema | Scheme **A**



Esquema | Scheme **B**



Esquema | Scheme **C**



Esquema | Scheme **D**



LED TUBE T9 CIRCULAR

Abaixo estão representados os esquemas elétricos standard para a sua luminária LED TUBE Circular (T9).
Below are the standard wiring diagrams for your Circular LED TUBE luminaire (T9).

Esquema | Scheme **E**

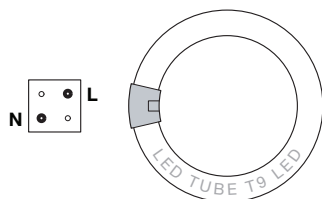

Esquema | Scheme **F**

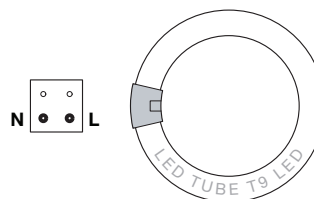

A-Z

GENERAL INDEX

A

	pag
AAV Surface	154
ACDE Surface	040
ACO Surface	044
ADAS E60 Surface	028
ADAS Opal Surface	026
AIN IP40 Reflector Surface	148
AIN Reflector Surface	144
ASH Wall	156
ATA Surface	038
ATAC Surface	134
ATE BASIC IP65 Clear Surface	126
ATE BASIC IP65 Opal Surface	120
ATE BASIC IP66 Clear Surface	128
ATE BASIC IP66 Opal Surface	122
ATE BASIC IP66 IK10 Clear Surface	130
ATE BASIC IP66 IK10 Opal Surface	124

B

	pag
BLACKBOARD Wall / Suspended	160

C

	pag
CANTHOR Surface	042

D E F G H I J

	pag
DRIVERS and PROFILES	170

K

	pag
KINA Surface	010
KUBA Surface	012

L M

	pag
LED FLEX IP20	166
LED FLEX IP65	168

N

	pag
NANO-R14 IP40, IP65 Recessed	080
NANO-S17 IP40, IP65 Surface	064

NANO-T14 IP40, IP65 Trimless	088
NANO CORNER IP40, IP65 Surface	072
NANO EDGE IP40, IP65 Trimless	098

O

	pag
OFFICE PANEL Recessed	034
OFFICE-R E60 Recessed	032
OFFICE-R Opal Recessed	030
ONDATEC Surface	020

R

	pag
ROYAL Wall	022
ROYAL-C Surface	018
ROYAL-R Surface	016

S

	pag
SIRIUS 120, 170, 225 Recessed	048
SIRIUS-D 137 IP44 Recessed	050
SIRIUS-D 187 IP44 Recessed	052
SIRIUS-R 184 RO Recessed	054
SIRIUS-R SQ Duo Orientable Recessed	058
SIRIUS-R SQ Single Orientable Recessed	056
SLIM Surface	138
SLIM IP40 Surface	140
SLIM T5 Surface	142

T U

	pag
TETRA-C Suspended	008
TUPOLI 70 IP40 Surface	112
TUPOLI 70 IP40 Suspended	110
TUPOLI 70 IP65/IP66 Surface	118
TUPOLI 70 IP65/IP66 Suspended	116

V X Y W Z

	pag
VITA Surface	014

3 years
guarantee

5 years
guarantee

Três ou Cinco anos de garantia

Os produtos Climar beneficiam de uma garantia de três ou cinco anos de acordo com as condições de garantia em www.climarlighting.com.

As informações contidas neste catálogo referem-se à data de impressão, não são vinculativas e devem ser usadas apenas para fins informativos. Reservamos o direito de fazer alterações aos nossos produtos a qualquer momento. Para obter dados atualizados regularmente, informações técnicas e fotométricas, certificados de qualidade e fichas de produto, por favor consulte a nossa página web em www.climarlighting.com.

Este catálogo anula e substitui anteriores edições e pode ser alterado sem aviso prévio.

Three or Five-year guarantee

Climar products are covered by a 3 or 5-year manufacturer's guarantee in accordance with the terms of guarantee at www.climarlighting.com.

Information in this catalogue was valid at the time of printing, is non-binding, and should be used for information purposes only. We reserve the right to make changes to our products at any time. For regularly updated data, technical and photometric information, quality certificates and product data sheets please refer to our website www.climarlighting.com.

This catalogue nullifies all previous versions and it may be changed without notice.

Concept / Graphic Design

Climar Lighting

Photo

Climar Lighting

Print

Orgal Impressores

Acknowledgements

Conference Center (Bank's Head Office)
Design Factory Aveiro
Hotel Governador
Kalorias Fitness Club
Quinta do Encontro
RACE - Refrigeration & Air Conditioning Engineering
Saint Jaques de la Land Church
UCC Oliveira do Bairro

Special thanks to the above companies
for their permission to publish photos.

Copyright © **Climar Lighting**

All rights reserved.

04.2021 - First Edition

DVM.253.20.2

For the latest edition of the Catalogue,
please visit www.climarlighting.com.

essential light for your daily life



Climar - Indústria de Iluminação, S.A.

Headquarters

Rua Estrada Real, 50
3750-866 Águeda - Portugal

Lisbon Office

Rua Amorim, 2
1950-022 Lisboa - Portugal

t +351 234 690 330 | **m** +351 915 599 110

e geral@climar.pt

London Office

31 – 35 Kirby Street
London EC1N 8TE - UK

t +44 (0)20 7492 1707 | **m** +44 (0)749 637 8770

e info@climarlighting.co.uk

Cofinanciado por:



UNIÃO EUROPEIA
Fundo Europeu
de Desenvolvimento Regional