

JSL

Material Eléctrico

CATÁLOGO CATALOGUE 2026-2027



JSL

Material Eléctrico

JSL - Material Eléctrico, S.A

Sede | Headquarters | Siège Social

Rua Mário Castelhana, nº3 - Zona Industrial Queluz de Baixo
2730 - 120 Barcarena - Portugal
Tel (+351) 214 344 670 | Fax (+351) 214 353 150
M (+351) 919975067 - (+351) 932 535 255 - (+351) 962736709

Fábrica | Factory | Usine

Estrada das Palmeiras 34, Queluz de Baixo
2734-504 Barcarena - Portugal

Sucursal em Espanha | Spanish Branch | Sucursal en España

Avenida Democracia Nº 7 Nave 112 Planta 1, Edificio Indubuilding 5
28031 Madrid - España
Tel (+34) 913322828 | M (+34) 619788098 | Fax (+34) 913320151
info.jsl@gmail.com



JSL - Building the future around the world

**Macau/Macau
Singapura/Singapore
Sri Lanka/Sri Lanka
Hong Kong/Hong Kong**

**Jordânia/Jordan
Siria/Syria
Israel/Israel
Emirados Árabes
Unidos/United Arab
Emirates
Libano/Lebanon**

**Antilhas Holandesas /
Neth. Antilles
Venezuela/Venezuela
Equador/Ecuador
Perú/Peru
Colômbia/Colombia
Brasil/Brazil
Chile/Chile
Costa Rica/Costa Rica
Argentina/Argentina**

**Angola/Angola
Tunísia/Tunisia
Cabo Verde/Cape Verde
Moçambique/Mozambique
Egipto/Egypt
Kênia/Kenya
Marrocos/Morocco
Argélia/Algeria
São Tomé e Príncipe/Sao
Tome & Príncipe
Maurícia/Mauritius
Benim/Benin
África do Sul/South Africa
Madagáscar/Madagascar**

**Portugal/Portugal
Espanha/Spain
França/France
Grécia/Greece
Bélgica/Belgium
Holanda/Netherlands
Itália/Italy
Alemanha/Germany
Finlândia/Finland
Suécia/Sweden
Suíça/Swiss
Irlanda/Ireland
Polónia/Poland
Malta/Malta
Estónia/Estonia
Dinamarca/Denmark
Roménia/Romania
Rússia/Russia
Bulgária/Bulgaria
Eslovénia/Slovenia
Áustria/Austria
Lituânia/Lithuania
Reino Unido/United
Kingdom
Hungria/Hungary
Chipre/Cyprus
República Checa/Czech
Republic**

Quem somos? O que fazemos?

A nossa fábrica foca-se no desenvolvimento de soluções de material elétrico de alta performance, que nascem da escuta ativa dos nossos clientes e parceiros, resultando em sistemas que resolvem os desafios reais em obra e conferem maior agilidade e precisão em menos tempo, ao trabalho dos instaladores.

Como organização competitiva e dinâmica, antecipamos as tendências do setor e focamos os nossos esforços numa constante autossuperação. Analisamos de forma contínua cada solução para garantir o cumprimento dos mais rigorosos padrões de qualidade, segurança e durabilidade, acompanhando as exigências da modernidade e a constante evolução tecnológica.



A força da experiência

O nosso rigor é assegurado pela competência técnica da nossa equipa. Integramos a visão de designers, arquitetos, construtores e instaladores, convergindo diferentes especialidades da indústria para o desenvolvimento de produtos tecnicamente avançados.

Engenharia para a performance

O compromisso com a excelência é o fio condutor deste catálogo. Projetamos cada produto sob critérios que asseguram:

- Instalação intuitiva e otimizada.
- Rapidez na montagem, permitindo um ganho de tempo significativo em cada projeto.
- Funcionalidade superior no quotidiano.
- Fiabilidade e manutenção simplificada a longo prazo.

Compromisso com a entrega e disponibilidade

Empenhamo-nos diariamente na otimização da nossa cadeia logística, investindo em sistemas de gestão que visam garantir a máxima disponibilidade e o cumprimento dos prazos de entrega. O nosso foco é a transparência e o apoio constante ao cliente, trabalhando lado a lado para encontrar as melhores soluções de fornecimento.

Das origens sólidas à presença global

Mais de seis décadas de visão, inovação e resiliência. A história da JSL começou há mais de 65 anos (1958), quando a família Thorbjørnsen antecipou a crescente procura por material elétrico em Portugal.

A evolução do portfólio

Nas décadas de 60 e 70, a JSL consolidou os seus primeiros passos com a produção de fichas e tomadas elétricas para uso doméstico, a par de equipamentos de iluminação de pequena escala. O final dessa década marcou um ponto de viragem estratégico: a inauguração da primeira unidade fabril e o desenvolvimento de linhas especializadas para instalações elétricas de baixa tensão, um segmento onde hoje somos especialistas reconhecidos.

Ambição sem fronteiras

A década de 80 trouxe o desafio da integração de Portugal na União Europeia. Num cenário económico complexo, a JSL optou pelo caminho da audácia: em vez de recuar, investi numa nova unidade produtiva, diversificou as suas linhas e desenhou uma estratégia de internacionalização que nos levou além-fronteiras.

O presente: Uma marca global

Hoje, a JSL é uma marca globalmente difundida, respeitada e reconhecida pela excelência dos seus produtos, estando presente em projetos de referência em todo o mundo. Agora na sua quarta geração, a JSL preserva a identidade e o rigor da gestão familiar Thorbjørnsen, projetando os seus valores fundadores para os desafios do futuro.

Rigor normativo, sustentabilidade e confiança de mercado

A JSL assume a qualidade e a responsabilidade ambiental como pilares inegociáveis. Somos pioneiros em Portugal na implementação de sistemas de gestão de excelência, consolidando o nosso percurso de rigor (iniciado em 1993 com a ISO 9001) através da certificação do Sistema de Gestão da Qualidade (ISO 9001) e do Sistema de Gestão Ambiental (ISO 14001), ambas reconhecidas pela APCER e pela rede internacional IQNET.

Todos os nossos sistemas cumprem escrupulosamente a marcação CE, indo além das obrigações legais. Asseguramos total transparência e ética através da nossa Declaração de Garantia e do compromisso com a Declaração de Origem e Minerais de Conflito, garantindo a conformidade e segurança das nossas gamas perante os mais exigentes padrões globais.

Sustentabilidade: O nosso compromisso com o futuro

A responsabilidade ambiental é um pilar estruturante da nossa estratégia. Acreditamos que o desenvolvimento industrial deve ser indissociável da sustentabilidade e da preservação dos ecossistemas. Reconhecemos o nosso papel ativo nesta transição e assumimos o dever de implementar medidas concretas para minimizar a pegada ambiental das nossas operações.

Como? Política dos 4R: Reduzir, Racionalizar, Reutilizar e Reciclar

A nossa gestão operacional, alinhada com a norma ISO 14001, foca-se na eficiência máxima dos recursos. Esforçamo-nos por integrar práticas de economia circular em todas as etapas do negócio:

- Reduzir: Minimização sistemática de desperdícios em linha de produção e redução da pegada ecológica.
- Racionalizar: Otimização rigorosa do consumo energético e de matérias-primas vírgens.
- Reutilizar e Reciclar: Promovemos um ciclo de vida sustentável ao integrar, sempre que possível, material reciclado no nosso processo produtivo. Garantimos que esta prática cumpre os elevados padrões de qualidade e segurança (Marcação CE) dos nossos produtos, sem comprometer a sua performance técnica.

Gestão e conformidade ambiental

Damos prioridade às melhores práticas de gestão ambiental, assegurando o cumprimento integral das normas vigentes. A nossa equipa avalia e valoriza continuamente o impacto dos processos de fabrico, procurando sempre as soluções tecnicamente mais evoluídas e ecologicamente responsáveis.





¿Quiénes somos? ¿Qué hacemos?

Nuestra fábrica se enfoca en el desarrollo de soluciones de material eléctrico de alto rendimiento, que nacen de la escucha activa de nuestros clientes y socios, resultando en sistemas que resuelven los desafíos reales en obra y aportan mayor agilidad y precisión en menos tiempo al trabajo de los instaladores. Como organización competitiva y dinámica, anticipamos las tendencias del sector y enfocamos nuestros esfuerzos en una constante autosuperación. Analizamos de forma continua cada solución para garantizar el cumplimiento de los más rigurosos estándares de calidad, seguridad y durabilidad, acompañando las exigencias de la modernidad y la constante evolución tecnológica.

La fuerza de la experiencia

Nuestro rigor está asegurado por la competencia técnica de nuestro equipo. Integramos la visión de diseñadores, arquitectos, constructores e instaladores, convergiendo diferentes especialidades de la industria para el desarrollo de productos técnicamente avanzados.

Ingeniería para la performance El compromiso con la excelencia es el hilo conductor de este catálogo. Proyectamos cada producto bajo criterios que aseguran:

- Instalación intuitiva y optimizada.
- Rapidez en el montaje, permitiendo un ahorro de tiempo significativo en cada proyecto.
- Funcionalidad superior en el día a día.
- Fiabilidad y mantenimiento simplificado a largo plazo.

Compromiso con la entrega y disponibilidad

Nos esforzamos diariamente en la optimización de nuestra cadena logística, invirtiendo en sistemas de gestión que buscan garantizar la máxima disponibilidad y el cumplimiento de los plazos de entrega. Nuestro enfoque es la transparencia y el apoyo constante al cliente, trabajando codo con codo para encontrar las mejores soluciones de suministro.

De los orígenes sólidos a la presencia global

Más de seis décadas de visión, innovación y resiliencia. La historia de JSL comenzó hace más de 65 años (1958), cuando la familia Thorbjørnsen anticipó la creciente demanda de material eléctrico en Portugal.

La evolución del portafolio

En las décadas de los 60 y 70, JSL consolidó sus primeros pasos con la producción de clavijas y enchufes para uso doméstico, junto con equipos de iluminación de pequeña escala. El final de esa década marcó un punto de inflexión estratégico: la inauguración de la primera unidad fabril y el desarrollo de líneas especializadas para instalaciones eléctricas de baja tensión, un segmento donde hoy somos especialistas reconocidos.

Ambición sin fronteras

La década de los 80 trajo el desafío de la integración de Portugal en la Unión Europea. En un escenario económico complejo, JSL optó por el camino de la audacia: en lugar de retroceder, invirtió en una nueva unidad productiva, diversificó sus líneas y diseñó una estrategia de internacionalización que nos llevó más allá de las fronteras.

El presente: una marca global

Hoy, JSL es una marca globalmente difundida, respetada y reconocida por la excelencia de sus productos, estando presente en proyectos de referencia en todo el mundo. Ahora en su cuarta generación, JSL preserva la identidad y el rigor de la gestión familiar Thorbjørnsen, proyectando sus valores fundacionales hacia los desafíos del futuro.

Rigor normativo, sostenibilidad y confianza de mercado

JSL asume la calidad y la responsabilidad ambiental como pilares innegociables. Somos pioneros en Portugal en la implementación de sistemas de gestión de excelencia, consolidando nuestro recorrido de rigor (iniciado en 1993 con la ISO 9001) a través de la certificación del Sistema de Gestión de la Calidad (ISO 9001) y del Sistema de Gestión Ambiental (ISO 14001), ambas reconocidas por APCER y la red internacional IQNET. Todos nuestros sistemas cumplen escrupulosamente con el mercado CE, yendo más allá de las obligaciones legales. Aseguramos total transparencia y ética a través de nuestra Declaración de Garantía y el compromiso con la Declaración de Origen y Minerales de Conflicto, garantizando la conformidad y seguridad de nuestras gamas ante los más exigentes estándares globales.

Sostenibilidad: nuestro compromiso con el futuro

La responsabilidad ambiental es un pilar estructurante de nuestra estrategia. Creemos que el desarrollo industrial debe ser indisoluble de la sostenibilidad y la preservación de los ecosistemas. Reconocemos nuestro papel activo en esta transición y asumimos el deber de implementar medidas concretas para minimizar la huella ambiental de nuestras operaciones.

¿Cómo? política de los 4R: Reducir, Racionalizar, Reutilizar y Reciclar Nuestra gestión operativa, alineada con la norma ISO 14001, se centra en la eficiencia máxima de los recursos. Nos esforzamos por integrar prácticas de economía circular en todas las etapas del negocio:

- Reducir: minimización sistemática de desperdicios en la línea de producción y reducción de la huella ecológica.
- Racionalizar: optimización rigurosa del consumo energético y de materias primas vírgenes.
- Reutilizar y reciclar: promovemos un ciclo de vida sostenible al integrar, siempre que sea posible, material reciclado en nuestro proceso productivo. Garantizamos que esta práctica cumple con los elevados estándares de calidad y seguridad (Marcado CE) de nuestros productos, sin comprometer su rendimiento técnico.

Gestión y conformidad ambiental

Damos prioridad a las mejores prácticas de gestión ambiental, asegurando el cumplimiento integral de las normas vigentes. Nuestro equipo evalúa y valora continuamente el impacto de los procesos de fabricación, buscando siempre las soluciones técnicamente más evolucionadas y ecológicamente responsables.



Who are we? What do we do?

Our factory focuses on developing high-performance electrical material solutions born from active listening to our customers and partners. This results in systems that solve real on-site challenges, providing installers with greater agility and precision in less time. As a competitive and dynamic organization, we anticipate industry trends and focus our efforts on constant self-improvement. We continuously analyze every solution to ensure compliance with the strictest standards of quality, safety, and durability, keeping pace with modern demands and constant technological evolution.

The strength of experience

Our rigor is ensured by our team's technical competence. We integrate the vision of designers, architects, builders, and installers, converging different industry specialties to develop technically advanced products.

Engineering for performance A commitment to excellence is the driving force of this catalog. We design every product under criteria that ensure:

- Intuitive and optimized installation.
- Fast assembly, allowing for significant time savings in every project.
- Superior daily functionality.
- Reliability and simplified long-term maintenance.

Commitment to delivery and availability

We strive daily to optimize our logistics chain, investing in management systems aimed at ensuring maximum availability and meeting delivery deadlines. Our focus is transparency and constant customer support, working side-by-side to find the best supply solutions.

From solid origins to a global presence

More than six decades of vision, innovation, and resilience. The history of JSL began over 65 years ago (1958), when the Thorbjørnsen family anticipated the growing demand for electrical material in Portugal.

The evolution of the portfolio

In the 60s and 70s, JSL consolidated its first steps by producing electrical plugs and sockets for domestic use, alongside small-scale lighting equipment. The end of that decade marked a strategic turning point: the opening of the first manufacturing unit and the development of specialized lines for low-voltage electrical installations, a segment where we are now recognized specialists.

Ambition without borders

The 80s brought the challenge of Portugal's integration into the European Union. In a complex economic landscape, JSL chose the path of audacity: instead of retreating, it invested in a new production unit, diversified its lines, and designed an internationalization strategy that took us beyond borders.

The present: a global brand

Today, JSL is a globally distributed brand, respected and recognized for the excellence of its products, featured in reference projects worldwide. Now in its fourth generation, JSL preserves the identity and rigor of the Thorbjørnsen family management, projecting its founding values toward the challenges of the future.

Regulatory rigor, sustainability and market trust

JSL considers quality and environmental responsibility non-negotiable pillars. We are pioneers in Portugal in implementing excellence management systems, consolidating our path of rigor (started in 1993 with ISO 9001) through Quality Management System (ISO 9001) and Environmental Management System (ISO 14001) certifications, both recognized by APCER and the international IQNET network. All our systems strictly comply with CE marking, going beyond legal obligations. We ensure total transparency and ethics through our Warranty Declaration and our commitment to the Origin and Conflict Minerals Declaration, guaranteeing the compliance and safety of our ranges against the most demanding global standards.

Sustainability: our commitment to the future

Environmental responsibility is a structural pillar of our strategy. We believe industrial development must be inseparable from sustainability and ecosystem preservation. We recognize our active role in this transition and assume the duty to implement concrete measures to minimize the environmental footprint of our operations.

How? policy of the 4Rs: Reduce, Rationalize, Reuse and Recycle

Our operational management, aligned with the ISO 14001 standard, focuses on maximum resource efficiency. We strive to integrate circular economy practices at all business stages:

- Reduce: systematic minimization of waste in the production line and reduction of the ecological footprint.
- Rationalize: rigorous optimization of energy and raw material consumption.
- Reuse and recycle: we promote a sustainable lifecycle by integrating, whenever possible, recycled material into our production process. We ensure this practice meets the high quality and safety standards (CE Marking) of our products without compromising technical performance.

Environmental management and compliance

We prioritize the best environmental management practices, ensuring full compliance with current regulations. Our team continuously evaluates and improves the impact of manufacturing processes, always seeking the most technically advanced and ecologically responsible solutions.



Qui sommes-nous? Que faisons-nous?

Notre usine se concentre sur le développement de solutions de matériel électrique de haute performance, nées de l'écoute active de nos clients et partenaires, aboutissant à des systèmes qui répondent aux défis réels sur le terrain et offrent plus d'agilité et de précision en moins de temps au travail des installateurs. En tant qu'organisation compétitive et dynamique, nous anticipons les tendances du secteur et concentrons nos efforts sur un dépassement de soi constant. Nous analysons continuellement chaque solution pour garantir le respect des normes de qualité, de sécurité et de durabilité les plus strictes, en suivant les exigences de la modernité et l'évolution technologique constante.

La force de l'expérience

Notre rigueur est assurée par la compétence technique de notre équipe. Nous intégrons la vision des designers, architectes, constructeurs et installateurs, faisant converger différentes spécialités de l'industrie pour le développement de produits techniquement avancés.

Ingénierie pour la performance

L'engagement envers l'excellence est le fil conducteur de ce catalogue. Nous concevons chaque produit selon des critères qui assurent :

- Une installation intuitive et optimisée.
- Rapidité de montage, permettant un gain de temps significatif sur chaque projet.
- Une fonctionnalité supérieure au quotidien.
- Fiabilité et maintenance simplifiée à long terme.

Engagement envers la livraison et la disponibilité

Nous nous efforçons quotidiennement d'optimiser notre chaîne logistique, en investissant dans des systèmes de gestion visant à garantir une disponibilité maximale et le respect des délais de livraison. Notre priorité est la transparence et le soutien constant au client, en travaillant main dans la main pour trouver les meilleures solutions d'approvisionnement.

Des origines solides à la présence mondiale

Plus de six décennies de vision, d'innovation et de résilience. L'histoire de JSL a commencé il y a plus de 65 ans (1958), lorsque la famille Thorbjørnsen a anticipé la demande croissante de matériel électrique au Portugal.

L'évolution du portefeuille

Dans les années 60 et 70, JSL a consolidé ses premiers pas avec la production de fiches et de prises électriques à usage domestique, ainsi que d'équipements d'éclairage à petite échelle. La fin de cette décennie a marqué un tournant stratégique : l'inauguration de la première unité de production et le développement de lignes spécialisées pour les installations électriques à basse tension, un segment dont nous sommes aujourd'hui des spécialistes reconnus.

Ambition sans frontières

La décennie 80 a apporté le défi de l'intégration du Portugal dans l'Union Européenne. Dans un scénario économique complexe, JSL a choisi la voie de l'audace : au lieu de reculer, elle a investi dans une nouvelle unité de production, a diversifié ses lignes et a conçu une stratégie d'internationalisation qui nous a menés au-delà des frontières.

Le présent : une marque mondiale

Aujourd'hui, JSL est une marque mondialement diffusée, respectée et reconnue pour l'excellence de ses produits, étant présente dans des projets de référence à travers le monde. Désormais à sa quatrième génération, JSL préserve l'identité et la rigueur de la gestion familiale Thorbjørnsen, projetant ses valeurs fondatrices vers les défis du futur.

Rigueur normative, durabilité et confiance du marché

JSL considère la qualité et la responsabilité environnementale comme des piliers non négociables. Nous sommes pionniers au Portugal dans la mise en œuvre de systèmes de gestion d'excellence, consolidant notre parcours de rigueur (initié en 1993 avec l'ISO 9001) par la certification du Système de Management de la Qualité (ISO 9001) et du Système de Management Environnemental (ISO 14001), toutes deux reconnues par l'APCER et le réseau international IQNET. Tous nos systèmes respectent scrupuleusement le marquage CE, allant au-delà des obligations légales. Nous assurons une transparence et une éthique totales grâce à notre Déclaration de Garantie et à notre engagement envers la Déclaration d'Origine et des Minéraux de Conflit, garantissant la conformité et la sécurité de nos gammes face aux normes mondiales les plus exigeantes.

Sustentabilité: notre engagement pour l'avenir

La responsabilité environnementale est un pilier structurant de notre stratégie. Nous pensons que le développement industriel doit être indissociable de la durabilité et de la préservation des écosystèmes. Nous reconnaissons notre rôle actif dans cette transition et assumons le devoir de mettre en œuvre des mesures concrètes pour minimiser l'empreinte environnementale de nos opérations.

Comment? politique des 4R: Réduire, Rationaliser, Réutiliser et Recycler Notre gestion opérationnelle, alignée sur la norme ISO 14001, se concentre sur l'efficacité maximale des ressources. Nous nous efforçons d'intégrer des pratiques d'économie circulaire à toutes les étapes de l'entreprise :

- Réduire: minimisation systématique des déchets sur la ligne de production et réduction de l'empreinte écologique.
 - Rationaliser: optimisation rigoureuse de la consommation d'énergie et de matières premières vierges.
 - Réutiliser et recycler: nous promovons un cycle de vie durable en intégrant, chaque fois que possible, des matériaux recyclés dans notre processus de production.
- Nous garantissons que cette pratique respecte les normes élevées de qualité et de sécurité (marquage CE) de nos produits, sans compromettre leur performance technique.

Gestion et conformité environnementale

Nous donnons la priorité aux meilleures pratiques de gestion environnementale, en assurant le respect intégral des normes en vigueur. Notre équipe évalue et valorise continuellement l'impact des processus de fabrication, en recherchant toujours les solutions techniquement les plus évoluées et écologiquement responsables.

Stop drowning in paperwork!

All our technical and commercial documentation, now in one single place.

jsl-online.com/biblioteca



**NEW
APP**

Documentation,
Declarations,
Certifications,
Brochures, etc.

JSL

ÍNDICE

www.ortecnic.com

CONTENIDO
INDEX
TABLE DES MATIÈRES

ENERGIAS RENOVÁVEIS
ENERGIAS RENOVABLES
RENEWABLE ENERGY
ÉNERGIE RENOUVELABLE 8

POSTOS DE TRABALHO
PUESTOS DE TRABAJO
WORKSTATIONS
POSTES DE TRAVAIL 10

CALHAS E ACESSÓRIOS
CANALETAS Y ACCESORIOS
TRUNKING SYSTEMS & ACCESSORIES
GOULOTTES ET ACCESSOIRES 18

APARELHAGEM
MECANISMOS
SWITCHES AND SOCKETS
APPAREILLAGE 44

FICHAS E TOMADAS INDUSTRIAIS
TOMAS DE CORRIENTE INDUSTRIAL
INDUSTRIAL PLUGS & SOCKETS
PRISES ET FICHES INDUSTRIELLES 50

CAIXAS ESTANQUES, BUCINS E LIGADORES
CAJAS ESTANCAS, PRENSAESTOPAS Y CONECTORES
CABLE JUNCTION BOXES, CABLE GLANDS AND CONNECTORS
BOÎTIERS ÉTANCHES, PRESSE-ÉTOUPES ET CONNECTEURS 60

CAIXAS PARA INSTALAÇÃO INTERIOR
CAJAS PARA INSTALACIÓN EMPOTRADA
FLUSH MOUNTING BOXES
BOÎTES D'ENCASTREMENT 98

QUADROS DE DISTRIBUIÇÃO
CUADROS DE DISTRIBUCIÓN DE ENERGÍA
DISTRIBUTION BOARDS
COFFRETS DE DISTRIBUTION 108

CAIXAS DE COLUNA MONTANTE E CAIXAS DE CONTADOR
CAJAS DE DERIVATION COLUMN MONTANTE Y CAJAS DE CONTADOR
DISTRIBUTION BOARDS & ENCLOSURES
COFFRETS POUR COLONNE MONTANT ET COFFRETS POUR COMPTEUR 116

MATERIAL DE FIXAÇÃO
FIJACIONES
FIXING MATERIALS
MATÉRIEL DE FIXATION 120

TUBOS E ACESSÓRIOS
TUBOS Y ACCESORIOS
CONDUITS AND FITTINGS
CONDUITS ET ACCESSOIRES 132

ILUMINAÇÃO
ILUMINACIÓN
LIGHTING
ÉCLAIRAGE 142

ITED - INFRA-ESTRUTURAS DE TELECOMUNICAÇÕES EM EDIFÍCIOS 146

BASTIDORES PARA CABLAGEM ESTRUTURADA
BASTIDORES PARA CABLEADO ESTRUCTURADO
CABINETS FOR DATA CABLING
ARMOIRES POUR CÂBLAGE STRUCTURÉS 158

SUPER T

www.nortecnica.pt

JSL
Material Eléctrico

jsl-online.com

Abraçadeira Premium JSL

Esta nova série apresenta um design moderno, pensado para substancial incremento de funcionalidade e versatilidade, sem esquecer a compatibilidade com a série anteriores de abraçadeiras e acessórios.

JSL Premium Saddle

This new series features a modern design, designed to substantially increase functionality and versatility, without forgetting compatibility with the previous series of saddles and accessories.

Abrazadera JSL Premium

Esta nueva serie presenta un diseño moderno, pensado para aumentar sustancialmente la funcionalidad y versatilidad, sin olvidar la compatibilidad con la serie anterior de Abrazaderas y accesorios similares.

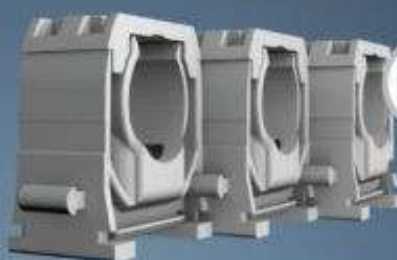

Agrupáveis
Stackable
Agrupable



Tampa desenhada para impedir a remoção e mantendo a instalação firmemente fixada



Cover designed to prevent removal and keep the installation firmly secured

Cubierta diseñada para impedir la extracción y mantener la instalación firmemente sujeta

PERNOS E ACESSÓRIOS
DOW/WELS AND FIXING ACCESSORIES
TACOS Y ACCESORIOS

Compatíveis
Compatible

Nativos
Natives

901

RM6

215

PST-5

PST-7

PSTB-4

PSTB-7



ST-CLIP



ST-BASE

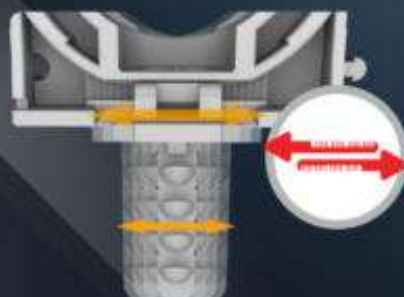

Micro ajustamento com 10 passos
Micro adjustment with 10 steps
Micro ajuste con 10 pasos



Utilize o código QR para saber mais >
Use the QR code to learn more >
Utilice el código QR para saber más >



PT



EN



ES

ENERGIAS RENOVÁVEIS

Energias renovables
Renewable energy
Énergies renouvelables





Plug&Play

Termoplástico
Termoplastico
Thermoplastic
Thermoplastique-5°C
+60°CCinza
Gris
Grey
Gris

55

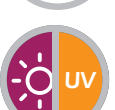

08

Classe de isol. 2
Clase de aisl. 2
Insul. degree 2
Class d'isolation 2Proteção anti-UV
Protección contra-UV
Anti-UV protection
Protection contre-UVSeláveis
Precintable
Can be sealed
ScellageCalha DIN
Carril DIN
DIN Rail
Rail DIN3/4
Fecho com parafuso a 3/4
Cierre por tornillos a 3/4
Closed by screws at 3/4
Ferme par des vis a 3/4

RoHS



HALOGEN FREE



REACH



CE

Seláveis
Precintable
Can be sealed
Scellage

SCAN + INFO

Combiner Box Proteção para Instalações Solares Fotovoltaicas DC | Protección para instalaciones solares fotovoltaicas DC
Protection for DC Solar Photovoltaic Installations | Protection des systèmes solaires photovoltaïques à courant continuNOVO
NEW

SolarSafe®

JSL Combiner Box • Photovoltaic Protection

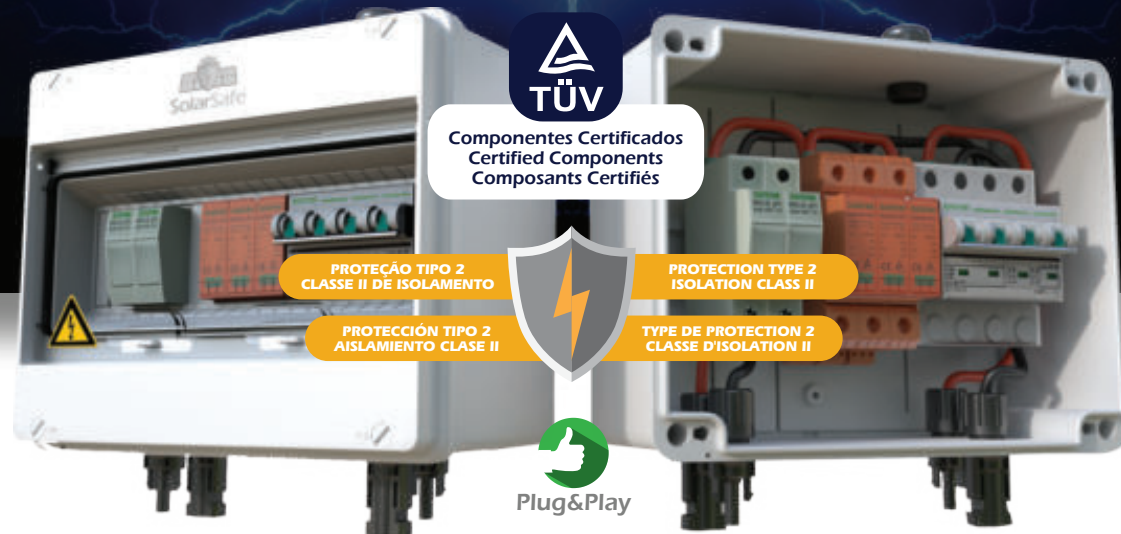
Componentes Certificados
Certified Components
Composants CertifiésPROTEÇÃO TIPO 2
CLASSE II DE ISOLAMENTOPROTECTION TYPE 2
ISOLATION CLASS IIPROTECCIÓN TIPO 2
AISLAMIENTO CLASE IITYPE DE PROTECTION 2
CLASSE D'ISOLATION II

Plug&Play

PROTEJA O SEU
INVESTIMENTO

A combiner box SolarSafe poderá ser usada para 1 ou 2 "strings" de painéis solares e para Correntes até 25A IMAX e 1000 V DC cobrindo mais de 95% das necessidades de auto-consumo com ou sem injeção de potência na Rede Elétrica. O Quadro é adequado para "Inverters" de 550V DC / 100V DC por Input (por String).

PROTEJA SU
INVERSIÓN

La caja combo SolarSafe puede utilizarse para 1 o 2 «cadenas» de paneles solares y para corrientes de hasta 25A IMAX y 1000 V DC, cubriendo más del 95% de las necesidades de autoconsumo con o sin inyección de energía en la Red Eléctrica. La placa es adecuada para inversores de 550V DC / 100V DC por entrada (por cadena)

PROTECT YOUR
INVESTMENT

The SolarSafe combiner box can be used for 1 or 2 strings of solar panels and for currents up to 25A IMAX and 1000 V DC covering more than 95% of the self-consumption needs with or without injection of power into the grid. The Quadro is suitable for "Inverters" of 550V DC / 100V DC per Input (per String).

PROTÉGEZ VOTRE
INVESTISSEMENT

Le boîtier de combinaison SolarSafe peut être utilisé pour 1 ou 2 strings de panneaux solaires et pour des courants jusqu'à 25A IMAX et 1000 V DC couvrant plus de 95% des besoins d'autoconsommation avec ou sans injection de courant dans le réseau. Le Quadro est adapté aux "Inverters" de 550V DC / 100V DC par entrée (par string).

Componentes | Components | Composants

Interruptor DC
Interruptor principal DC
DCmain switch
Interrupteur principal DCou
orLimitador de sobretensão tipo 2 DC
Limitador de sobretensión tipo 2 DC
Overvoltage limiter type 2 DC
Limiteur de surtension type 2 DCPorta fusíveis DC 10x38
Portafusibles DC 10x38
DC fuseholders 10x38
Porte-fusible DC 10x38Cablagem interna de 6 mm2 conectores MC-4
Cablagem interna de 6 mm2 conectores MC-4
6 mm2 wiring used MC-4 connectors
6 mm2 wiring used MC-4 connectors

(fornecido sem fusíveis | supplied without fuses | suministrado sin fusibles | fournis sans fusibles)

Ref.	Strings		SMC4 (in)	SMC4 (out)	Y-X-Z Dim.(mm)	IP	IK
CBS-SL7	1	SL7	2	2	182 x 232 x 109	55	08
CBS-SISO	1	SISO	2	2	182 x 232 x 109	55	08
CBS-SL7-II	2	SL7	4	2	182 x 232 x 109	55	08
CBS-SISO-II	2	SISO	4	2	182 x 232 x 109	55	08

POSTOS DE TRABALHO

Puestos de trabajo
Work stations
Postes de travail





Termoplástico
Termoplastic
Thermoplastic
Thermoplastique



-25° C
+60° C



Cinza | Preto
Gris | Negro
Gray | Black
Gris | Noir



IP 4x



IK 09



750 N
5000 N



Fix. por parafusos e garras
Fija. por tornillos y garras
Fix. by screws and clamps
Fix. avec des vis et griffes



Formato ajustável
Formato ajustable
Adaptable Format
Format adaptable



NORMAS
STANDARDS
NORME

EN 60670-1
EN 50085-1
EN 50085-2-2



Caixas de chão JSL para aparelhagem tipo 45x45 e 45x90
Cajas de suelo JSL para mecanismos tipo 45x45 y 45x90
JSL Floor Boxes for 45x45 and 45x90 switches and sockets
Boîte de sol JSL pour mécanismes 45x45 et 45x90



745-8C ref.

8 mod's com chapa de aço galvanizada
8 mod's con chapa de acero galvanizado
8 Mod's with steel galvanized plate
8 mod's avec plaque d'acier galvanisé



745-8SC ref.

8 mod's sem chapa de aço galvanizada
8 mod's sin chapa de acero galvanizado
8 mod's without steel galvanized plate
8 mod's sans plaque d'acier galvanisé

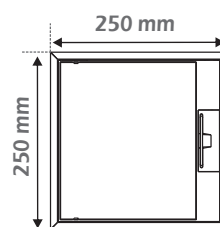

DIMENSÕES | DIMENSIONES
DIMENSIONS | DIMENSIONS



-Solução perfeita para soalho técnico e chão compacto de cimento
-Solución perfecta para suelo técnico y pavimento de hormigón
-Perfect solution for both concrete and raised technical floor
-Solution idéale pour le sol technique en planchers et pour le chape béton



745-4C ref.

4 mod's com chapa de aço galvanizada
4 mod's con chapa de acero galvanizado
4 mod's with steel galvanized plate
4 mod's avec plaque d'acier galvanisé



745-4SC ref.

4 mod's sem chapa de aço galvanizada
4 mod's sin chapa de acero galvanizado
4 mod's without steel galvanized plate
4 mod's sans plaque d'acier galvanisé

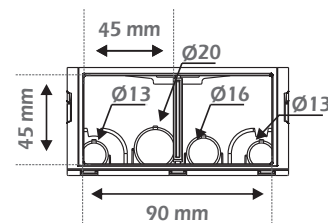
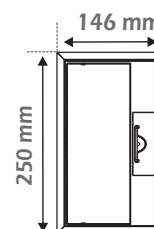

Para alojamento de 2 tomadas tipo 45 x 45 ou uma tomada dupla de 45 x 90
Para alojamiento de 2 tomas tipo 45 x 45 o una toma doble de 45 x 90
For housing for two 45 x 45 type sockets or one for 45 x 90 double sockets
Pour loger deux prises de type 45 x 45 ou une prise double 45 x 90

Ref.	Dim. (mm)	IP	IK
745-8C	250x250x56	4X	09
745-8SC	250x250x56	4X	09
745-4C	250x146x56	4X	09
745-4SC	250x146x56	4X	09



SCAN + INFO

Acessórios | Accesorios | Accessories | Acesoires



Termoplástico
Termoplastico
Thermoplastic
Thermoplastique



-25° C
+60° C



Cinza | Preto
Gris | Negro
Gray | Black
Gris | Noir



IP 4x



IK 09



750 N
5000 N



Fix. por parafusos e garras
Fija. por tornillos y garras
Fix. by screws and clamps
Fix. avec des vis et griffes



Formato ajustável
Formato ajustable
Adaptable Format
Format adaptable



NORMAS
STANDARDS
NORME

EN 60670-1
EN 50085-1
EN 50085-2-2

Profundidade tampa
Profundidad tapa
Cover depth
Profondeur couverture

7,5mm

Sem chapa de aço
Sin placa de acero
Without steel plate
Sans plaque d'acier



SCAN + INFO

CFR748 ref.

"Forma" para cimento para caixa de chão 4 e 8 mod's
Registro para hormigón para caja suelo 4 y 8 mod's
Concrete frame for floor box of 4 and 8 mod's
Pièce encastrement béton pour boîte sol de 4 et 8 mod's

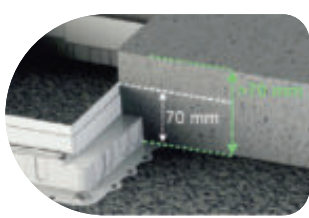
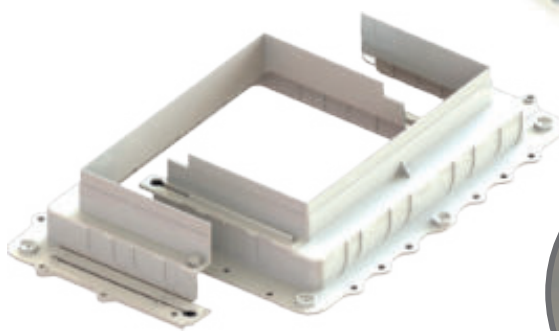

Para camadas de betonilha superiores a 70 mm, recomenda-se a utilização de bloco de esferovite.
Para alturas de hormigón superiores a 70 mm, se recomenda el uso del bloque de poliestireno.
For concrete layers thicker than 70 mm, the use of "Mudcap" bloc is recommended.
Pour l'alture de béton superior a 70 mm, utiliser le bloque de PS.

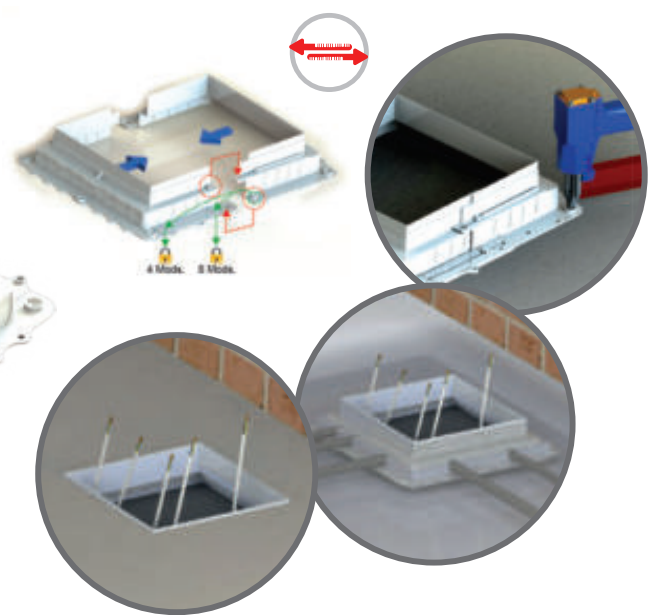

EPS8M ref.



Bloco de esferovite para caixa de 8 mod's
Bloque de poliestireno para caja de 8 mod's
"Mudcap" bloc for box of 8 mod's
Bloques de PS pour boîte de 8 mod's



Para camadas de betonilha superiores a 83 mm, utilizar garra especial contida na embalagem
Para alturas de hormigón superiores a 83 mm, utilizar garra especial contenida en el embalaje
For concrete layers thicker than 83 mm, use special claw contained in the pack
Pour l'hauteur de béton supérieur a 83 mm, utiliser griffes especiales contenues dans l'emballage

EPS4M ref.



Bloco de esferovite para caixa de 4 mod's
Bloque de poliestireno para caja de 4 mod's
"Mudcap" bloc for box of 4 mod's
Bloques de PS pour boîte de 4 mod's

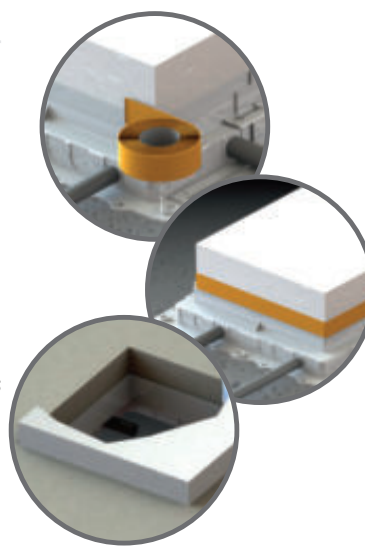

758 ref.

Placa metálica 8 mod's (espessura 2,5 mm)
Placa metalica 8 mod's (espesor 2,5 mm)
Metalic plate 8 mod's (thickness 2,5 mm)
Plaque métallique 8 mod's (épaisseur 2,5 mm)

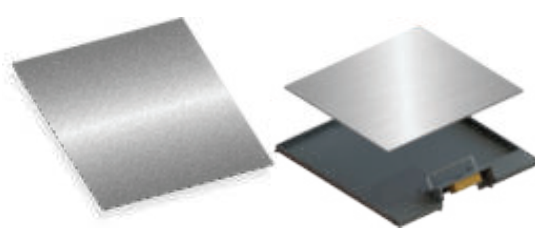

754 ref.

Placa metálica 4 mod's (espessura 2,5 mm)
Placa metalica 4 mod's (espesor 2,5 mm)
Metalic plate 4 mod's (thickness 2,5 mm)
Plaque métallique 4 mod's (épaisseur 2,5 mm)

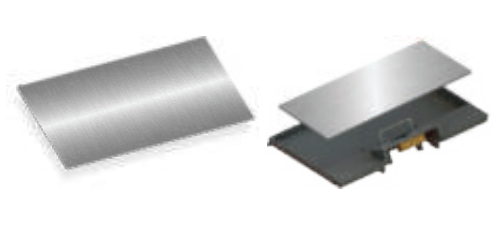



Termoplástico
Termoplastico
Thermoplastic
Thermoplastique

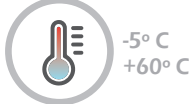

-5° C
+60° C



Branco
Blanco
White
Blanche



IP 40



IK 08



Instal. c/ Cabos e Tubos
Instal. c/ Cables y Tubos
Install w/ Cab. and conduits
Instal. av/ Câbles et Tubes



Recebe Aparelhagem Direct.
Recibe Mecanismos Directo
Directly Receives Switches and Sockets
Installation Direct de Apareillage

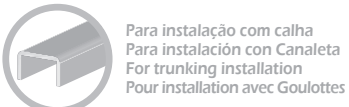

Para instalação com calha
Para instalación con Canaleta
For trunking installation
Pour installation avec Goulottes

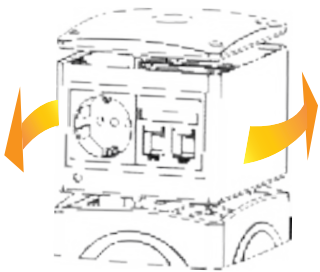

Escolha do ângulo do corpo da torre em função das necessidades de conectividade

Elección del ángulo del cuerpo de la torre en función de las necesidades de conectividad

Choosing the angle of the tower body according to the needs of connectivity

Choisir l'angle du corps de la tour selon les besoins de la connectivité



SCAN + INFO



TORRE DE CHÃO Over Floor Socket Tower

Adicione até 3 andares

Add up to 3 floors

TR7018 ref.



Aparelhagem não incluída
Mecanismos no incluido
Switches and sockets not included
Interrupteurs et prises non inclus

4x 45x45
2x 45x90

Consultar capítulo Aparelhagem - Switches and sockets chapter
Capítulo de mecanismos - Chapitre interrupteurs et prises

Torre de chão completa (1 Andar)
Torreta de suelo completa (1 Piso)
Over Floor Socket Tower (1 Floor)
Mini-colonne complète (1 étage)

Acessórios | Accesorios | Accessories | Accessoires

LED IS-L ref.



Indicador LED de tomada com corrente
LED indicador de toma llevando corriente
LED lamp socket current indicator
Lamp LED indicateur de courant dans le prise

CR7018 ref.



Corpo da torre 2 lados
Bloque 2 lados
Column body 2 sides
Corp de colonne 2 faces



Termoplástico
Termoplastico
Thermoplastic
Thermoplastique



-25° C
+60° C



Branco
Blanco
White
Blanche



Concepção
Diseño
Design
Conception



2x USB



3x schuko

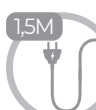

Comprimento de cabo (1,5m)
Longitud del cable (1,5 m)
Cable length (1,5m)
Longueur de câble (1.5m)

NOVO
NEW

PTW ref.

Power Tower - Tomada de carregamento
(3 schuko + 2 usb carga rápida)

Power Tower - Toma de carregamiento
(3 schuko + 2 usb carga rápida)

Power Tower - Charging station
(3 schuko + 2 usb fast charge)

Power Tower - Station de charge
(3 schuko + 2 usb charge rapide)

powertower
BY JSL



IT'S ON!

FAST CHARGE



Módulos USB de carga rápida 5V 2,1A
Puertos USB de carga rápida 5V 2,1A
Fast charge USB ports 5V 2,1A
Charge rapide des ports USB 5V 2,1A



Tomadas de proteção para crianças
Tomas de protección infantil
Child Protective Outlets
Prises de protection pour enfants



Comprimento de cabo (1,5m)
Longitud del cable (1,5 m)
Cable length (1,5m)
Longueur de câble (1.5m)



3 Tomadas de corrente
3 tomas de corriente
3 Power outlets
3 Prises de courant



Especificações Técnicas:
• Tipo de Carregador : Tomada eléctrica e USB
• Outputs: 3 tomadas schucko e 2 portas USB de carga rápida 5V, 2.1A
• Voltagens compatíveis: 110-240 V
• Cabo de alimentação/extensão de 1,5m

Technical specifications:
• Charger Type: Power Socket and USB
• Outputs: 3 schucko sockets and 2 USB ports for fast charging 5V, 2.1A
• Compatible voltages: 110-240 V
• 1,5m power cord/extension cord

Especificaciones tecnicas:
• Tipo de cargador: Toma eléctrica y USB
• Outputs: 3 tomas schucko y 2 puertos USB de carga rápida 5V, 2.1A
• Voltajes compatibles: 110-240 V
• Cable de alimentación/extensión de 1,5m

Spécifications techniques
• Type de chargeur: Prise de courant et USB
• Sorties: 3 prises schucko et 2 ports USB pour une charge rapide 5V, 2.1A
• Tensions compatibles: 110-240 V
• Cordon d'alimentation de 1,5m



SMARTPHONES, TABLETS, GAMEPADS, CONSOLES, CAMERAS, DSLRS...



SCAN + INFO

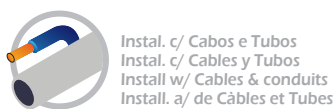
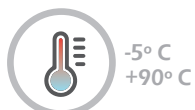

PEÇAS INCLUÍDAS

*POR MODELO

	CE245	CE445	CE645
	x1	x2	x3
	x4	x4	x4

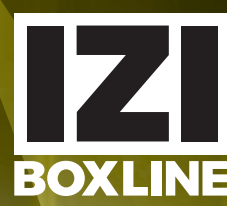

Caixas de distribuição de encastrar (pladur e para reboco)
Cajas de distribución para instalación empotrada (pladur y ladrillo)
Flush mounting distribution boxes for plaster and concrete walls
Boîtes encastrement de distribution d'cloisons sèches et béton

CE245 ref.



Caixa de encastrar 2 mód. 45x45
Caja de empotrar 2 mod. 45x45
Flush mouting box for 2x45x45 mod.
Boîte d'encastrement pour 2 modules 45x45

com Moldura de acabamento | con Marco de acabado | with Finishing frame | avec Cadre de finition

CE245C ref.



Caixa Completa
Caja Completa
Complete Box
Boîte complète

CE245 + 745 IS-L

CE445 ref.



Caixa de encastrar 4 mód. 45x45
Caja de empotrar 4 mod. 45x45
Flush mouting box for 4x45x45 mod.
Boîte d'encastrement pour 4 mod. 45x45

com Moldura de acabamento | con Marco de acabado | with Finishing frame | avec Cadre de finition

CE445C ref.



Caixa Completa
Caja Completa
Complete Box
Boîte complète

CE445 + 745 IS-L

CE645 ref.



Caixa de encastrar 6 mód. 45x45
Caja de empotrar 6 mod. 45x45
Flush mouting box for 6x45x45 mod.
Boîte d'encastrement pour 6 mod. 45x45

com Moldura de acabamento | con Marco de acabado | with Finishing frame | avec Cadre de finition

CE645C ref.

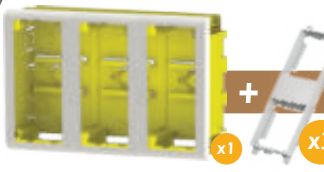

Caixa Completa
Caja Completa
Complete Box
Boîte complète

CE645 + 745 IS-L

COMPATÍVEL
COMPATIBLE

Versão de encastrar compatível com as seguintes medidas de tubo anelado: JS20 e JS25

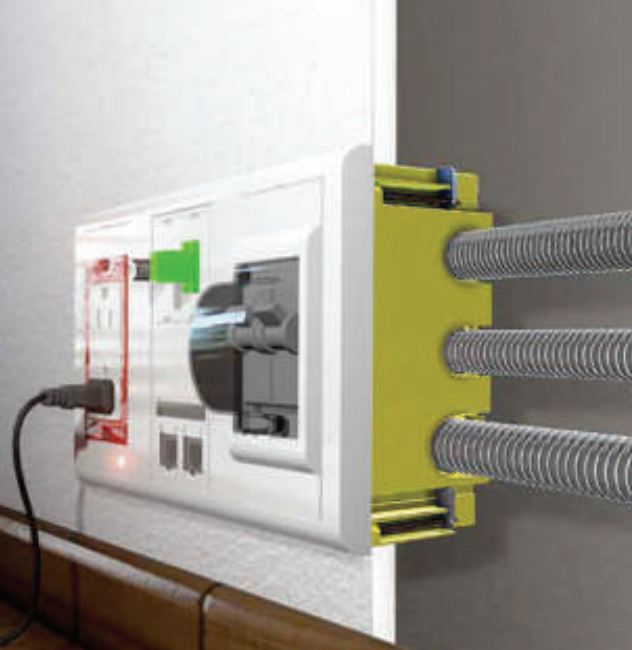
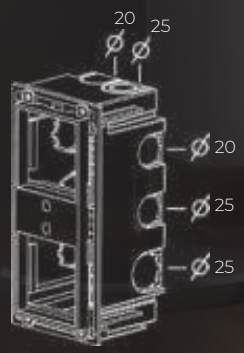

Flush mounted version compatible with corrugated pipe: JS20 and JS25.



SCAN + INFO

Acessórios IZI BOXLINE | Accesorios IZI BOXLINE
IZI BOXLINE Accessories | Accessoires IZI BOXLINE

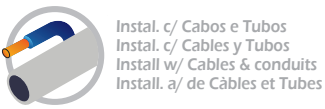
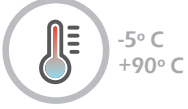

745 IS-L ref.

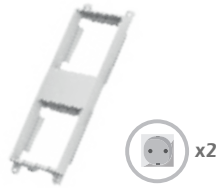

Para 2 tomadas tipo 45x45
 Para 2 tomas tipo 45x45
 For 2 sockets type 45x45
 Pour 2 prises type 45x45

745-2SK ref.

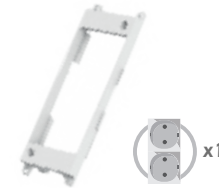

Para Tomada dupla SCHUKO
 Para Toma doble SCHUKO
 For SCHUKO double socket
 Pour Prise double SCHUKO

NEM ALIS-L ref.

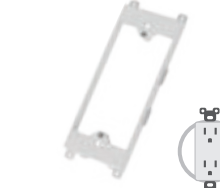

Para Tomada dupla NEMA
 Para Toma doble NEMA
 For NEMA double socket
 Pour Prise double NEMA

745-CD ref.



Tampa cega 90x45
 Tapa ciega tipo 90x45
 Double blank cover 90x45
 Couvertcle aveugle 90x45

DIS-L ref.



Para 2 Mod.s Disjuntor
 Para 2 Mod.s Disyuntores
 For 2 MCB's
 Pour 2 Disjoncteurs

PIS-L ref.



Peça de união
 Pieza de enlace
 Linkage piece
 Piece de liaison

745-C ref.



Tecla Cega 45x45
 Tecla Ciega 45x45
 Blank Cover 45x45
 Couvert. Aveugle 45x45

745-MC ref.



1/2 Tecla Cega
 1/2 Tecla Ciega
 1/2 Blank Cover
 1/2 Couvert. Aveugle

LED IS-L ref.



Indicador LED de tomada com corrente
 LED indicador de toma llevando corriente
 LED lamp socket current indicator
 Lamp LED indicateur de courant dans le prise

MODULAR MODULAIRE



SCAN + INFO



CALHAS E ACESSÓRIOS

Canaletas y accesorios
Trunking systems & accessories
Goulottes et accessoires

wall
**Bottom
Trunking**

CÓDIGO DE COR | COLOR CODE

**Floor
Trunking**

CÓDIGO DE COR | COLOR CODE

inway

HF
HALOGEN FREE

inway

CÓDIGO DE COR | COLOR CODE

**round
way**

CÓDIGO DE COR | COLOR CODE

fluidline

CÓDIGO DE COR | COLOR CODE

SIMPLICIDADE REQUINTADA | EXQUISITE SIMPLICITY
ROBUSTEZ | ROBUSTNESS
ESTÉTICA | AESTHETICS
DIVERSIDADE | DIVERSITY

CALHAS DISPONÍVEIS NA VERSÃO:
TRUNKING AVAILABLE AS:



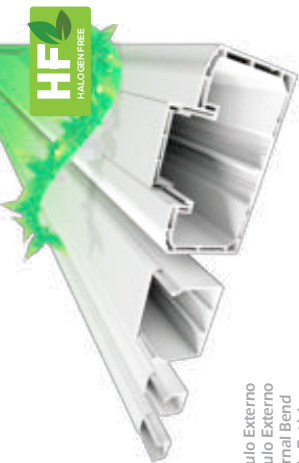

Calhas livres de Halogéneos
 Canaletas Libres de Halógenos
 Halogen Free Trunking system
 Système de goulotte sans halogène



Acessórios - Accessoires - Accessoires - Accessoires											
Ref.	Dim (mm)	Ot. (m)	l _{ext} (m)	m ³	Kg	AE	AI	AP	GT	GU	TT
2012,5BLH	20x12,5	80	2x0,15x0,1	0,03	10	AE2012,5B 50 (un)	AI2012,5B 50 (un)	AP2012,5B 50 (un)	GT2012,5B 50 (un)	GU2012,5B 50 (un)	TT2012,5B 50 (un)
2012,5BADLH	20x20	70	2x0,15x0,1	0,03	7,6 8,0	-	-	-	-	-	-
2020BLH	40x17	30	x	x	x	AE4017B 10 (un)	AI4017B 10 (un)	AP4017B 10 (un)	GT4017B 10 (un)	GU4017B 10 (un)	TT4017B 10 (un)
2020BADLH	40x40	46	x	x	x	AE4040B 10 (un)	AI4040B 10 (un)	AP4040B 10 (un)	GT4040B 10 (un)	GU4040B 10 (un)	TT4040B 10 (un)
4017BLH	60x40	32	2x0,23x0,135	0,062	16,2	AE6040B 10 (un)	AI6040B 10 (un)	AP6040B 10 (un)	GT6040B 10 (un)	GU6040B 10 (un)	TT6040B 10 (un)
4040BLH	100x54	12	2x0,23x0,135	0,062	10	AE10054B 10 (un)	AI10054B 10 (un)	AP10054B 10 (un)	GT10054B 10 (un)	GU10054B 10 (un)	TT10054B 10 (un)

- (AE) Ângulo Externo
External Bend
Angle Extérieur
- (AI) Ângulo Interior
Internal Bend
Angle Intérieur
- (AP) Ângulo Plano
Flat Bend
Angle Plat
- (GT) Derivação em T
Derivation en T
Té de dérivation
- (GU) União
Union
Coupler
Joint couvercle
- (TT) Tampa Terminal
Tapa Final
End Cap
Embout
- (Caixa) Caixa
Paquete
Package
Paquet



Calha técnica e minicanal
 Canaletas técnicas y minicanal
 Technical trunking and mini trunkings
 Goulottes techniques et mini goulottes



Acessórios - Accessoires - Accessoires - Accessoires

Ref.	Dim (mm)	Ot. (m)	l _{ext} (m)	m ³	Kg	AE	AI	AP	GT	GU	TT	Boxline
1207B	12x7	180	2x0,15x0,1	0,03	8,20	AE1207B 50 (un)	AI1207B 50 (un)	AP1207B 50 (un)	GT1207B 50 (un)	GU1207B 50 (un)	TT1207B 50 (un)	-
1207BAD	-	160	2x0,15x0,1	0,03	9,00	-	-	-	-	-	-	-
1610B	16x10	100	2x0,15x0,1	0,03	8,30	AE1610B 50 (un)	AI1610B 50 (un)	AP1610B 50 (un)	GT1610B 50 (un)	GU1610B 50 (un)	TT1610B 50 (un)	-
1610BAD	-	90	2x0,15x0,1	0,03	7,74	-	-	-	-	-	-	-
1517B	15x17	60	2x0,15x0,1	0,03	6,10	AE1517B 50 (un)	AI1517B 50 (un)	AP1517B 50 (un)	GT1517B 50 (un)	GU1517B 50 (un)	TT1517B 50 (un)	-
1517BAD	-	60	2x0,15x0,1	0,03	7,78	-	-	-	-	-	-	-
2010B	20x10	80	2x0,15x0,1	0,03	7,50	AE2010B 50 (un)	AI2010B 50 (un)	AP2010B 50 (un)	GT2010B 50 (un)	GU2010B 50 (un)	TT2010B 50 (un)	-
2010BAD	-	80	2x0,15x0,1	0,03	8,00	-	-	-	-	-	-	-
2012,5B	20x12,5	80	2x0,15x0,0	0,03	10	AE2012,5B 50 (un)	AI2012,5B 50 (un)	AP2012,5B 50 (un)	GT2012,5B 50 (un)	GU2012,5B 50 (un)	TT2012,5B 50 (un)	-
2012,5BAD	-	70	2x0,15x0,0	0,03	-	-	-	-	-	-	-	-
2020B	20x20	50	2x0,15x0,1	0,03	7,60	-	-	-	-	-	-	-
2020BAD	-	46	2x0,15x0,1	0,03	8,00	-	-	-	-	-	-	-
2517B	25x17	50	2x0,15x0,1	0,03	7,50	AE2517B 50 (un)	AI2517B 50 (un)	AP2517B 50 (un)	GT2517B 50 (un)	GU2517B 50 (un)	TT2517B 50 (un)	-
2517BAD	-	40	2x0,15x0,1	0,03	8,00	-	-	-	-	-	-	-
2525B	25x25	80	2x0,23x0,135	0,062	16,50	AE2525B 25 (un)	AI2525B 25 (un)	AP2525B 25 (un)	GT2525B 25 (un)	GU2525B 25 (un)	TT2525B 25 (un)	-
2525BAD	-	-	2x0,23x0,135	0,062	-	-	-	-	-	-	-	-
3010B	30x10	50	2x0,23x0,135	0,03	7,50	AE3010B 50 (un)	AI3010B 50 (un)	AP3010B 50 (un)	GT3010B 50 (un)	GU3010B 50 (un)	TT3010B 50 (un)	-
3010BAD	-	50	2x0,23x0,135	0,03	8,00	-	-	-	-	-	-	-
4017B	40x17	30	2x0,23x0,135	0,03	8,00	AE4017B 50 (un)	AI4017B 50 (un)	AP4017B 50 (un)	GT4017B 50 (un)	GU4017B 50 (un)	TT4017B 50 (un)	-
4017BAD	-	50	2x0,23x0,135	0,03	18,00	-	-	-	-	-	-	-
4040B	40x40	46	2x0,23x0,135	0,062	16,00	AE4040B 25 (un)	AI4040B 25 (un)	AP4040B 25 (un)	GT4040B 25 (un)	GU4040B 25 (un)	TT4040B 25 (un)	-
6040B	60x40	32	2x0,23x0,135	0,062	16,20	AE6040B 10 (un)	AI6040B 10 (un)	AP6040B 10 (un)	GT6040B 10 (un)	GU6040B 10 (un)	TT6040B 10 (un)	-
8040B	80x40	24	2x0,23x0,135	0,062	15,87	AE8040B 10 (un)	AI8040B 10 (un)	AP8040B 10 (un)	GT8040B 10 (un)	GU8040B 10 (un)	TT8040B 10 (un)	-
10040B	100x40	16	2x0,23x0,135	0,062	13,50	AE10040B 10 (un)	AI10040B 10 (un)	AP10040B 10 (un)	GT10040B 10 (un)	GU10040B 10 (un)	TT10040B 10 (un)	-
10054B	100x54	12	2x0,23x0,135	0,062	13,50	AE10054B 6 (un)	AI10054B 6 (un)	AP10054B 6 (un)	GT10054B 6 (un)	GU10054B 6 (un)	TT10054B 6 (un)	-

Accessórios - Accesorios - Accessoires											
Ref.	Dim(mm)	Qt. (m)	█ m	m ³	Kg	AE	AI	AP	GT	GU	TT
B7040	70x40	36	2x0,23x0,135	0,062	16,00	AE7040 10 (un)	AI7040 10 (un)	AP7040 10 (un)	GT7040 10 (un)	GU7040 10 (un)	TT7040 10 (un)
B7040-PLUS	70x45	32	2x0,23x0,135	0,062	17,60	AE7040-P 10 (un)	AI7040-P 10 (un)	AP7040-P 10 (un)	GT7040-P 10 (un)	GU7040-P 10 (un)	TT7040-P 10 (un)
B7060	70x60	24	2x0,23x0,135	0,062	15,56	AE7060 10 (un)	AI7060 10 (un)	AP7060 10 (un)	GT7060 10 (un)	GU7060 10 (un)	TT7060 10 (un)
B10054	100x54	12	2x0,23x0,135	0,062	13,50	AE10054B 6 (un)	AI10054B 6 (un)	AP10054B 6 (un)	GT10054B 6 (un)	GU10054B 6 (un)	TT10054B 6 (un)
B10060	120x60	12	2x0,23x0,135	0,062	13,50	AE10060 5 (un)	AI10060 5 (un)	AP10060 5 (un)	GT10060 5 (un)	GU10060 5 (un)	TT10060 5 (un)

Derivação em T
Derivación en T
Tee
Té de dérivation



União
Unión
Coupler
Manchon



Ângulo Externo
Angulo Externo
External Bend
Angle Extérieur



Ângulo Interior
Angulo Interior
Internal Bend
Angle Intérieur



Derivação em T para curva de água
Derivación en T para curva de agua
Tee for water bend
Dérivation en T pour la courbe de l'eau



Adaptador para calha de rodapé
Adaptador para Canaleta de rodapie
Adapter for Bottom wall trunking
Adaptateur pour goulottes murales



Calha para tubagem de fluidos
Canaleta para tubería de fluidos
Trunking system for fluid pipes
Goulottes pour tuyaux de fluides

Accessórios - Accesorios - Accessoires												
Ref.	Dim(mm)	Qt. (m)	█ m	m ³	Kg	AE	AI	AP	GT	GU	TT	Redutor Reducer Réducteur
T3535	35x35	32	2x0,23x0,135	0,062	16,20	AE3535 10 (un)	AI3535 10 (un)	AP3535 10 (un)	GT3535 10 (un)	GU3535 10 (un)	TT3535 10 (un)	-
T7040	70x40	36	2x0,23x0,135	0,062	16,00	AE7040 10 (un)	AI7040 10 (un)	AP7040 10 (un)	GT7040 10 (un)	GU7040 10 (un)	TT7040 10 (un)	RT10040F 10 (un)
TT7040-Plus	70x45	32	2x0,23x0,135	0,062	17,60	AE7040-P 10 (un)	AI7040-P 10 (un)	AP7040-P 10 (un)	GT7040-P 10 (un)	GU7040-P 10 (un)	TT7040-P 10 (un)	RT10040F 10 (un)
T7060	70x60	24	2x0,23x0,135	0,062	15,56	AE7060 6 (un)	AI7060 6 (un)	AP7060 6 (un)	GT7060 6 (un)	GU7060 6 (un)	TT7060 6 (un)	RT10040BF 6 (un)
TT10060	120x60	12	2x0,23x0,135	0,062	13,50	AE10060 5 (un)	AI10060 5 (un)	AP10060 5 (un)	GT10060 5 (un)	GU10060 5 (un)	TT10060 5 (un)	-

Calha de chão instalação á superficie
Canaleta de suelo instalación en superficie
Over floor trunking surface-mounting floor
Passage de plancher montage sur surface au sol

Accessórios - Accesorios - Accessoires												
Ref.	Dim(mm)	Qt. (m)	█ m	m ³	Kg	AP	GU	AD	GT	GU	TT	
7018	70x18	20	2x0,23x0,135	0,062	15	AP7018 10 (un)	GU7018 25 (un)	AD7020 10 (un)	GT7020B 10 (un)	GU7020B 10 (un)	TT7020B 10 (un)	GR7018 1 (un)

Calha de rodapé
Canaleta rodapie
Bottom wall trunking
Goulotte murale

Accessórios - Accesorios - Accessoires													
Ref.	Dim(mm)	Qt. (m)	█ m	m ³	Kg	AE	AI	AP	GT	GU	TT	AD	
7020B	70x18	32	2x0,15x0,1	0,062	16,50	AE7020B 10 (un)	AI7020B 10 (un)	AP7020B 10 (un)	GT7020B 10 (un)	GU7020B 10 (un)	TT7020B 10 (un)	AD7020 10 (un)	873IN20 5 (un)
													873TC20 5 (un)



NOVO
NEW

Calha técnica triangular de Bancada para mecanismos 45x45 encaixe directo
Triangular bench trunking for 45x45 direct snap-on mechanisms



3ANGULAR

SOFISTICADA * ADAPTATIVA * INOVADORA
SOPHISTICATED * ADAPTABLE * INNOVATIVE

IP 41

IK 07

Blanco | Preto
White | Black
Blanche | Noir

Material termoplástico LH
Material termoplastico LH
Thermoplastic material HF
Matériel thermoplastique LH

Aplicação por pressão
Aplicación presión
Pressure application
Application à pression

Recebe Aparelhagem Direct.
Recibe Mecanismos Directo
Direct. Reciev. Switch. & Sockets
Install. Direct de Apareillage

Recebe Aparelh. c/ (acessório)
Recibe Mecanis. c/ (acessorios)
Reciev. Sock. (using accesorie)
Install. (avec des accessoires)

Accessórios (Pág. 35)
Accesorios (Pág. 35)
Available (Pag. 35)
Accessoires (Pag. 35)

Fixação por parafusos
Fijacion por tornillos
Fixing by screws
Fixation par des vis

45x45 Tipo Mosaic
45x45 Type Mosaic
45x45 Type Mosaic
45x45 Type Mosaïque

7575B ref.

Calha técnica triangular de Bancada
Calha técnica triangular de Bancada
Triangular bench trunking
Triangular bench trunking

MO
960°C

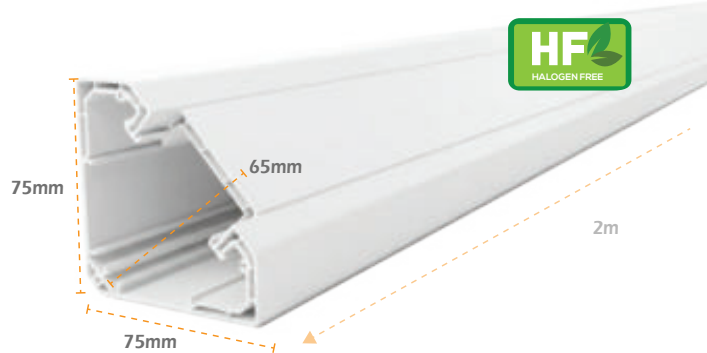

Design Inovador:

Formato triangular que se adapta perfeitamente a cantos ou a utilização sobre/sob tampo (tipo bloco de secretária).

Instalação Instantânea:

Compatibilidade nativa com a série JSL QuickVolt tomadas de ligação rápida sem parafuso. Encaixe direto na calha > clip instantâneo, sem ferramentas e sem acessórios extra.

Universal:

Compatível com todos os módulos de aparelhagem tipo 45x45, 45x90 e QUICKVOLT

Innovative Design:

Triangular shape that adapts perfectly to corners or for desktop/under-desk use (desk unit style).

Instant Installation:

Native compatibility with the JSL QuickVolt series of screwless quick-connection sockets. Direct snap-on into the trunking > instant clip, tool-free and without extra accessories.

Universal:

Compatible with all 45x45 and 45x90 type device modules and QUICKVOLT.



SCAN + INFO



UNDERDESK
INSTALLATION

TRUNKING CAN BE
CUT & CUSTOMIZED
FOR WORKSTATION
POWER DISTRIBUTION



Acessório de Acabamento | Finishing Accessories



DERIVAÇÃO EM T (Ângulo Interior 90°)
TEE (Internal 90° Bend)



AID 7575

ÂNGULO EXTERNO 90°
EXTERNAL 90° BEND



AE7575

ÂNGULO INTERIOR 90°
INTERNAL 90° BEND



AI7575

DERIVAÇÃO EM T
TEE

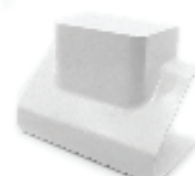

AD7575

TAMPA TERMINAL
END CAP SLIDE-IN



TT7575

TAMPA TERMINAL PARAFUSOS
END CAP SCREW-ON



TTS7575

ADAPTADOR VERTICAL PARA
INTERRUPTORES/TOMADAS 45x45
45X45 SWITCHES/SOCKETS
VERTICAL ADAPTER



SV7575

UNIÃO (Tampa & Base)
UNIÓN (Lid & Base Couplers)



GU7575

SEPARADOR CENTRAL PARA CALHA TÉCNICA
CENTRAL TRUNKING SEPARATOR



S10040

BASE PARA ABRAÇADEIRAS
(Organização De Cabos)
BASE FOR ZIP TIES
(Cable Organization)

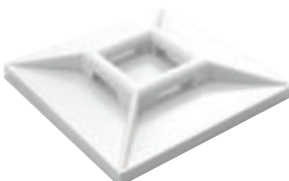

113-A

MÓDULO ADICIONAL 45x12,5 (Recortes Pré-marcados)
ADDITIONAL 45x12,5 MODULE (Pre-marked cutouts)



TAMPA TERMINAL
(De Encaixe)
END CAP
(Slide-in)

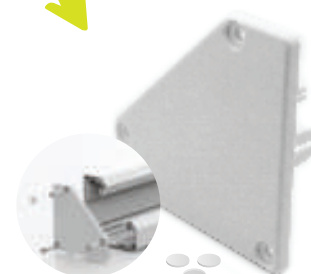

TAMPA TERMINAL APARAFUSADA
(com tampas de acabamento para
ocultação dos parafusos)
END CAP (SCREW-ON)
(With Finishing Concealing Caps)



3ANGULAR & quickvolt

Instantly Connected: Encaixe direto, sem ferramentas, velocidade máxima.

Instantly Connected: Direct snap-on, tool-free, maximum speed.

O sistema **3ANGULAR** integra-se nativamente com a gama JSL **QuickVolt**, eliminando parafusos e acessórios complexos.

Graças ao perfil **75x75x65** com abertura de 45mm, a aparelhagem encaixa diretamente com um 'clique', garantindo uma fixação robusta.

Reduza o tempo de instalação em até 70% com uma solução versátil para paredes, cantos e bancadas.

Ligação Rápida Push-in:

Terminais de conexão rápida. Basta descarnar e inserir (Cabos Rígidos).

Otimização de Espaço (Tomadas a 45°):

Permite ligar fichas e transformadores lado a lado sem bloqueios.

Segurança Total:

Tomadas com obturadores de proteção (segurança infantil) conforme a norma IEC 60884-1.

Carregamento Inteligente (USB A+C):

Carregadores duplos de 21W com Smart Charge para um carregamento rápido e seguro.

The **3ANGULAR** system integrates natively with the JSL **QuickVoltrange**, eliminating screws and complex accessories.

Thanks to the **75x75x65** profile with a 45mm opening, devices snap directly into the trunking, ensuring a robust fix.

Reduce installation time by up to 70% with a versatile solution for walls, corners, and desktops.

Push-in Fast Connection:

Quick connection terminals. Just strip the wire and insert (Rigid wires).

Space Optimization (45° Sockets):

Allows plugs and transformers to be connected side-by-side without blocking each other.

Total Safety:

Sockets include safety shutters (child protection) compliant with IEC 60884-1.

Smart Charging (USB A+C):

Dual 21W chargers with Smart Charge technology for fast and safe power delivery.

21W

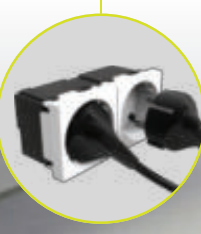

45°

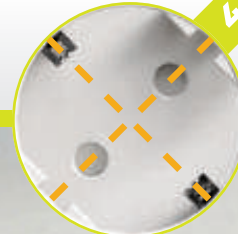

3ANGULAR

Do Escritório ao Laboratório

Calha técnica de bancada para mecanismos 45x45 de encaixe direto

A robustez do perfil triangular é ideal para ambientes exigentes como escolas e laboratórios. Permite o uso de separador de circuitos S10040 (dados/energia) e possui topos aparafusáveis opcionais para uma instalação à prova de manuseamento indevido.

Espaços Corporativos

Workstations: Instalação versátil sobre ou sob o tampo da secretária.

Reunião e Coworking: Soluções centrais e modulares para zonas partilhadas.

Laboratórios e Saúde

Investigação: A inclinação ergonómica facilita a conexão frequente de instrumentos analíticos.

Bancadas Técnicas: Perfeito para oficinas de eletrónica.

Saúde: Permite circuitos de emergência dedicados (tomadas vermelhas) lado a lado.

Residencial e Hoteleiro

Home Office: Organização profissional de cabos em casa.

Cantos de Cozinha: Instalação sob os armários superiores (encaixe perfeito no ângulo parede/armário).

Quartos de Hotel: Cabeceiras de cama ou zonas de secretária integradas.

Comércio e Retalho

Linhas de Caixa (POS): Alimentação de computadores e terminais de pagamento.

Montras e Expositores: Estética de calha funcional que não compromete o design do espaço.

From Office to Laboratory

Triangular bench trunking for 45x45 direct snap-on mechanisms

The robust triangular profile is ideal for demanding environments like schools and labs. It supports circuit separation S10040 (data/power) and features optional screw-on end caps for a tamper-proof installation.

Corporate Spaces

Workstations: Versatile installation on top of or under the desk.

Meeting & Coworking: Central and modular solutions for shared areas.

Labs & Healthcare

Research: The ergonomic angle eases the frequent connection of analytical instruments.

Technical Benches: Perfect for electronics workshops.

Healthcare: Allows for dedicated emergency circuits (red sockets) side-by-side.

Residential & Hospitality

Home Office: Professional in-home cable management.

Kitchen Corners: Under-cabinet installation (perfect fit for the wall/cabinet angle).

Hotel Rooms: Bed headboards or integrated desk areas.

Commercial & Retail

Checkout Counters (POS): Power supply for computers and payment terminals.

Shop Windows & Displays: Functional trunking aesthetics that do not compromise the space's design.

3ANGULAR

NOVO
NEW

Calhas Livres de Halogéneos | Canaletas Libres de Halogenos
Halogen Free Trunking system | Système de goulotte sans halogène

IP 41

IK 07

Blanco | Preto
White | Black
Blanche | Noir

Material termoplástico LH
Material termoplastico LH
Thermoplastic material HF
Matériel thermoplastique LH

Aplicação por pressão
Aplicación presión
Pressure application
Application à pression

Recebe Aparelhagem Direct.
Recibe Mecanismos Directo
Direct. Reciev. Switch. & Sockets
Install. Direct de Apareillage

Recebe Aparelh. c/(acessório)
Recibe Mecanis. c/(acessorios)
Reciev. Socd. (using accesorie)
Install. (avec des accessoires)

Accessórios (Pág. 35)
Accesorios (Pág. 35)
Available (Pag. 35)
Accessoires (Pag. 35)

Fixação por parafusos
Fijacion por tornillos
Fixing by screws
Fixation par des vis

Advertências
Advertencias
Warnings
Cautions

45x45 Tipo Mosaic
45x45 Type Mosaic
45x45 Type Mosaic
45x45 Type Mosaicque



SCAN + INFO

2012,5BLH ref.

Compatible With:
BOXLINE
CS SERIES

Calha 20x12,5 para cabos e aparelhagem
Canaleta 20x12,5 para cables y mecanismos
Trunking 20x12,5 for switches and sockets and cables
Goulottes 20x12,5 pour appareillage et câbles

MO 960°C

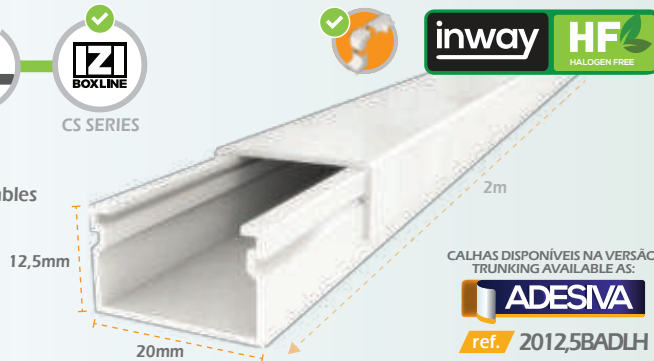

2020BLH ref.

Calha 20x20 para cabos
Canaleta 20x20 para cables
Trunking 20x20 system for cables
Goulottes 20x20 pour câbles

MO 960°C

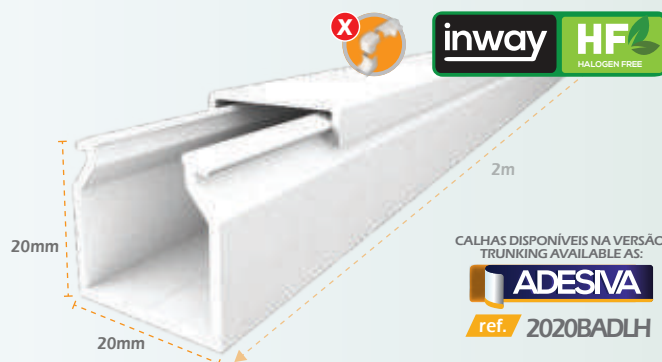

4017BLH ref.

Compatible With:
BOXLINE
CS SERIES
45IN17
45IN17D

Calha 40x17 para cabos
Canaleta 40x17 para cables
Trunking 40x17 system for cables
Goulottes 40x17 pour câbles

MO 960°C



4040BLH ref.

Calha 40x40 para cabos
Canaleta 40x40 para cables
Trunking 40x40 system for cables
Goulottes 40x40 pour câbles

MO 960°C



NOVO NEW

Calhas Livres de Halogéneos | Canaletas Libres de Halogenos
Halogen Free Trunking system | Système de goulotte sans halogène

IP 41

IK 07

Blanco | Preto
White | Black
Blanche | Noir

Material termoplástico LH
Material termoplastico LH
Thermoplastic material HF
Matériel thermoplastique LH

Aplicação por pressão
Aplicación presión
Pressure application
Application à pression

Recebe Aparelhagem Direct.
Recibe Mecanismos Directo
Direct. Reciev. Switch. & Sockets
Install. Direct de Apareillage

Recebe Aparelh. c/(acessório)
Recibe Mecaniss. c/(acessorios)
Reciev. Sock. (using accesorie)
Install. (avec des accessoires)

Accessórios (Pág. 35)
Accesorios (Pág. 35)
Available (Pag. 35)
Accessoires (Pag. 35)

Fixação por parafusos
Fijacion por tornillos
Fixing by screws
Fixation par des vis

Advertências
Advertencias
Warnings
Cautions

45x45 Tipo Mosaic
45x45 Type Mosaic
45x45 Type Mosaic
45x45 Type Mosaic



SCAN + INFO

6040BLH ref.



DOUBLE RAIL SYSTEM
For removable electrical separators.
Reduces electrical noise

SISTEMA DE CARRIL DUPLO
Para separadores removíveis.
Reduz ruído elétrico



Calha 60x40 para cabos
Canaleta 60x40 para cables
Trunking 60x40 system for cables
Goulotte 60x40 pour câbles

ref. S8040
MO 960°C



Separador vendido à parte
Divisoria se vende por separado
Spacer sold separately
Séparateur vendu séparément

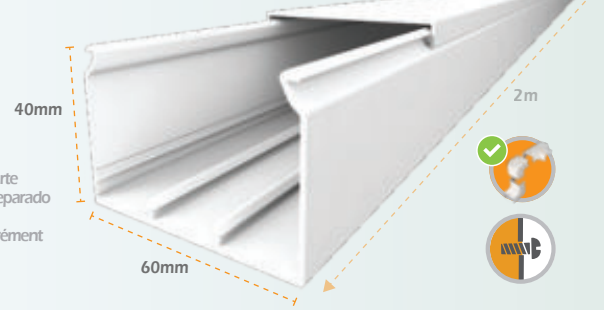

10054BLH ref.



Direct click
install!

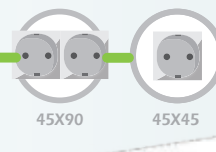

Calha 100x54 c/tampa para aparelhagem
Canaleta 100x54 c/tapa para mecanismos
Trunking 100x54 for switches and sockets
Goulotte 100x54 avec pour appareillage

MO 960°C

IK 10



Separador vendido à parte
Divisoria se vende por separado
Spacer sold separately
Séparateur vendu séparément

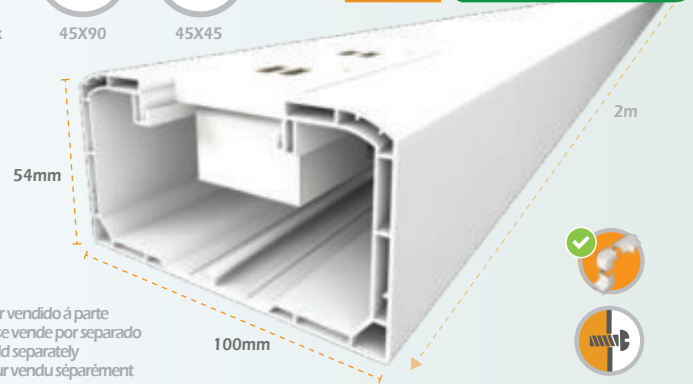

Ref.	Dim. Ext. (mm)	Dim. Int. (mm)	Área (S)mm ²	Área Útil (Su)(S): 1.2(mm) ²	Área Máx.	Nº Max Cabo 1,5 mm	Nº Max Cabo 2,5 mm	Nº Max Cabo 4 mm	Nº Max Cabo 6 mm	UTP CAT5e	UTP CAT6e	RG-6
2012,5BLH	20x12,5	18x10,5	189	125	10	10	8	5	4	3	2	2
2020BLH	20x20	18x17,5	315	205	17	21	15	11	6	6	5	5
4017BLH	40x17	2x(16x15)	570	370	15	32	22	19	10	10	9	6
4040BLH	40x40	39x38	1482	963	38	96	66	50	30	30	24	22
6040BLH	60x40	57x38	2166	1408	38	138	90	72	44	44	40	38
10054BLH	100x54	2x(37x44)	3250	2100	37	232	146	104	88	62	54	28



BLACK LABEL
SMART SOLUTIONS DRESSED IN BLACK

Calha para aparelhagem | Canaleta para mecanismos
Trunking system for switches and sockets | Goulottes pour appareillage

IP 41

IK 07

Blanco | Preto
Blanco | Negro
White | Black
Blanche | Noir

Termoplástico
Termoplastico
Thermoplastic
Thermoplastique

Aplicação por pressão
Aplicación presión
Pressure application
Application à pression

Recebe Aparelhagem Direct.
Recibe Mecanismos Directo
Direct. Reciev. Switch. & Sock.
Install. Direct de Appareillage

Recebe Aparelh. c/ (access.)
Recibe Mecaniss. c/(access.)
Reciev. Sock. (using access.)
Install. (avec des access.)

45x45 Tipo Mosaica
45x45 Type Mosaic
45x45 Type Mosaic
45x45 Type Mosaique

90x45 Tipo Mosaica
90x45 Type Mosaic
90x45 Type Mosaic
90x45 Type Mosaique

Accesórios (Pág. 35)
Accesorios (Pág. 35)
Available (Pag. 35)
Accessoires (Pag. 35)

Fixação por parafusos
Fijacion por tornillos
Fixing by screws
Fixation par des vis



SCAN + INFO

1207B ref.

ref. without adhesive

Calha 12x07 para cabos
Canaleta 12x07 para cables
Trunking 12x07 system for cables
Goulottes 12x07 pour câbles

CALHAS DISPONÍVEIS NA VERSÃO:
TRUNKING AVAILABLE AS:

ADESIVA
1207BAD ref.

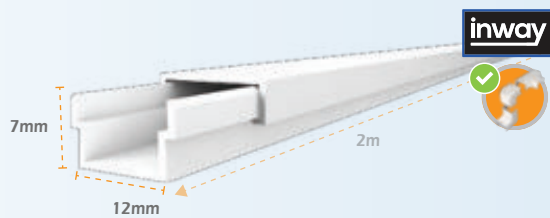

1610B ref.

ref. without adhesive

Calha 16x10 para cabos
Canaleta 16x10 para cables
Trunking 16x10 system for cables
Goulottes 16x10 pour câbles

CALHAS DISPONÍVEIS NA VERSÃO:
TRUNKING AVAILABLE AS:

ADESIVA
1610BAD ref.

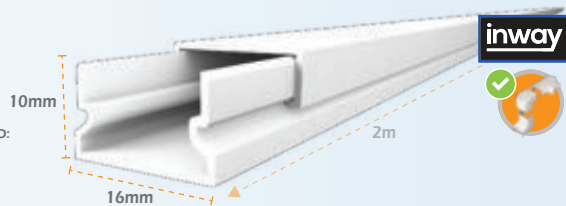

1517B ref.

ref. without adhesive

Calha 15x17 para cabos
Canaleta 15x17 para cables
Trunking 15x17 system for cables
Goulottes 15x17 pour câbles

CALHAS DISPONÍVEIS NA VERSÃO:
TRUNKING AVAILABLE AS:

ADESIVA
1517BAD ref.

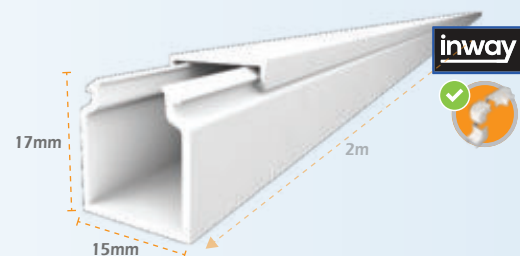

2010B ref.

ref. without adhesive

Calha 20x10 para cabos
Canaleta 20x10 para cables
Trunking 20x10 system for cables
Goulottes 20x10 pour câbles

Compatible With:

CALHAS DISPONÍVEIS NA VERSÃO:
TRUNKING AVAILABLE AS:

ADESIVA
2010BAD ref.

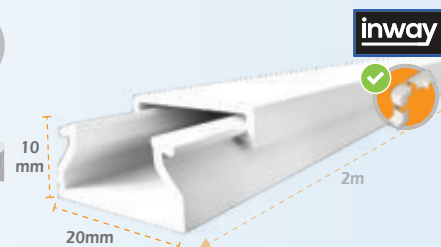

2012,5B ref.

ref. without adhesive

Calha 20x12,5 para cabos
Canaleta 20x12,5 para cables
Trunking 20x12,5 system for cables
Goulottes 20x12,5 pour câbles

Compatible With:

CALHAS DISPONÍVEIS NA VERSÃO:
TRUNKING AVAILABLE AS:

ADESIVA
2012,5BAD ref.

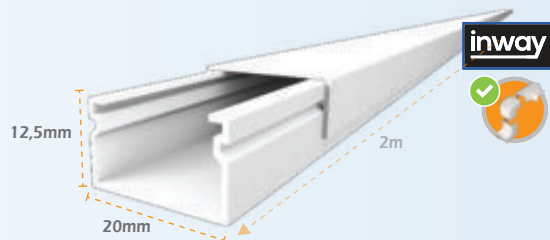

2020B ref.

ref. without adhesive

Calha 20x20 para cabos
Canaleta 20x20 para cables
Trunking 20x20 system for cables
Goulottes 20x20 pour câbles

CALHAS DISPONÍVEIS NA VERSÃO:
TRUNKING AVAILABLE AS:

ADESIVA
2020BAD ref.

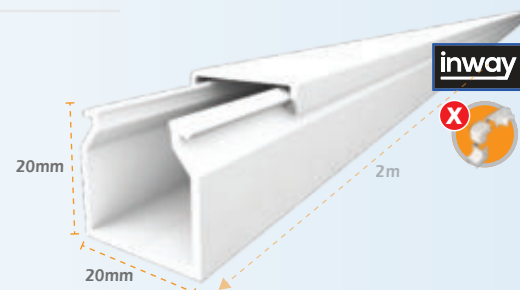

Ref.	Dim. Ext. (mm)	Dim. Int. (mm)	Área (S)mm ²	Área Útil (Su)(S):1.2/(mm) ²	Área Mâx.	Nº Max Cabo 1,5 mm	Nº Max Cabo 2,5 mm	Nº Max Cabo 4 mm	Nº Max Cabo 6 mm	UTP CAT5e	UTP CAT6e	RG-6
1207B	12x7	9x5,5	50	32	5,5	3	2	1	1	1	-	-
1610B	16x10	15x8	120	78	8	7	4	3	2	1	1	1
1517B	15x17	14x16	224	146	14	15	10	8	4	4	3	2
2010 B	20x10	18x8	144	94	8	9	6	4	3	2	2	2
2012,5B	20x12,5	17,5x11	192	125	10	10	8	5	4	3	2	2
2020B	20x20	18x17,5	315	205	17	21	15	11	6	6	5	5

Calha para aparelhagem | Canaleta para mecanismos
Trunking system for switches and sockets | Goulottes pour appareillage

IP 41

IK 07

Blanco | Preto
Blanco | Negro
White | Black
Blanche | Noir

Termoplástico
Termoplastico
Thermoplastic
Thermoplastique

Aplicação por pressão
Aplicación presión
Pressure application
Aplication à pression

Recebe Aparelhagem Direct.
Recibe Mecanismos Directo
Direct. Reciev. Switch. & Sock.
Install. Direct de Apareillage

Recebe Aparelh. c/ (access.)
Recibe Mecaniss. c/(access.)
Reciev. Sock. (using access.)
Install. (avec des access.)

45x45 Tipo Mosaic
45x45 Type Mosaic
45x45 Type Mosaic
45x45 Type Mosaique

90x45 Tipo Mosaic
90x45 Type Mosaic
90x45 Type Mosaic
90x45 Type Mosaique

Accessórios (Pág. 35)
Accesorios (Pág. 35)
Available (Pag. 35)
Accessoires (Pag. 35)

Fixação por parafusos
Fijacion por tornillos
Fixing by screws
Fixation par des vis



SCAN + INFO

2517B ref.

ref. without adhesive

Calha 25x17 para cabos
Canaleta 25x17 para cables
Trunking 25x17 system for cables
Goulottes 25x17 pour câbles

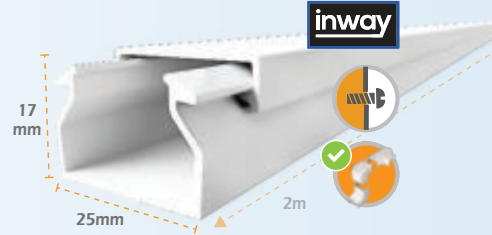

2525B ref.

ref. without adhesive

Calha 25x25 para cabos
Canaleta 25x25 para cables
Trunking 25x25 system for cables
Goulottes 25x25 pour câbles

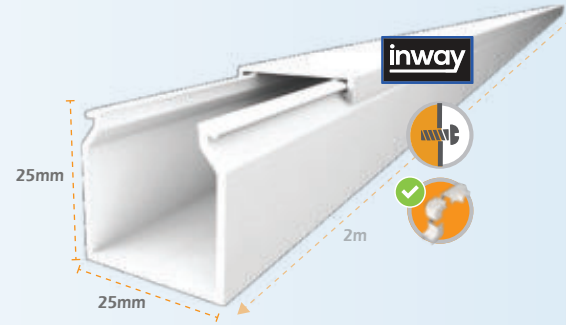
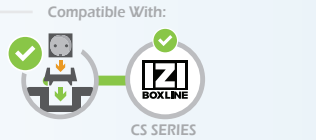

3010B ref.

ref. without adhesive

Calha 30x10 para cabos
Canaleta 30x10 para cables
Trunking 30x10 system for cables
Goulottes 30x10 pour câbles

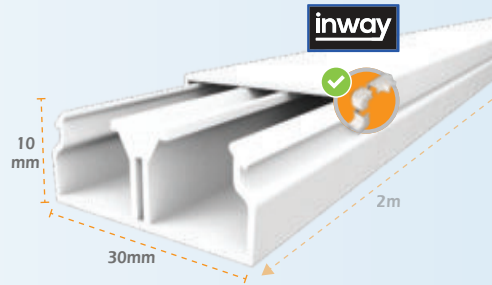
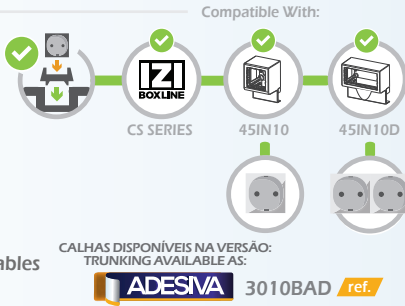

4017B ref.

ref. without adhesive

Calha 40x17 para cabos
Canaleta 40x17 para cables
Trunking 40x17 system for cables
Goulottes 40x17 pour câbles

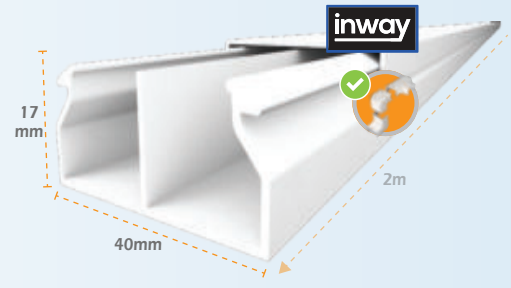

4040B ref.

Calha 40x40 para cabos
Canaleta 40x40 para cables
Trunking 40x40 system for cables
Goulottes 40x40 pour câbles



Ref.	Dim. Ext. (mm)	Dim. Int. (mm)	Área (S)mm ²	Área Útil (Su)(S)-1.2((mm) ²	Área Máx.	Nº Max Cabo 1,5 mm	Nº Max Cabo 2,5 mm	Nº Max Cabo 4 mm	Nº Max Cabo 6 mm	UTP CAT5e	UTP CAT6e	RG-6
2517B	25x17	23x15	345	224	15	24	16	13	7	6	5	4
2525B	25x25	24,5x24	588	382	24	40	28	21	12	12	10	9
3010B	30x10	2x(12x8)	224	145	8	12	8	6	4	2	2	2
4017B	40x17	2x(16x15)	570	370	15	32	22	19	10	10	9	6
4040B	40x40	39x38	1482	963	38	96	66	50	30	30	24	22

Calha para cabos e aparelhagem | Canaleta para cables y mecanismos
Trunking system for cables, switches and sockets | Goulottes pour câbles et appareillage

IP 41

IK 07

Blanco | Preto
White | Black
Blanche | Noir

Termoplástico
Termoplastic
Thermoplastic
Thermoplastique

Aplicação por pressão
Aplicación presión
Pressure application
Aplication à pression

Recebe Aparelhagem Direct
Recibe Mecanismos Directo
Direct. Reciev. Switch. & Sock.
Install. Direct de Appareillage

Recebe Aparelh. c/ (access.)
Recibe Mecannis. c/(access.)
Reciev. Sock. (using access.)
Install. (avec des access.)

45x45 Tipo Mosaica
45x45 Type Mosaic
45x45 Type Mosaic
45x45 Type Mosaïque

90x45 Tipo Mosaica
90x45 Type Mosaic
90x45 Type Mosaic
90x45 Type Mosaïque

Tipo NEMA
Type NEMA
Type NEMA
Type NEMA

Accessórios (Pág. 35)
Accesorios (Pág. 35)
Available (Pag. 35)
Accessoires (Pag. 35)

Fixação por parafusos
Fijacion por tornillos
Fixing by screws
Fixation par des vis



SCAN + INFO

6040B ref.



DOUBLE RAIL SYSTEM
For removable electrical separators that reduces electrical noise.z

SISTEMA DE CARRIL DUPLO
Para separadores removíveis que reduzem o ruído elétrico.

Calha 60x40 para cabos
Canaleta 60x40 para cables
Trunking 60x40 system for cables
Goulottes 60x40 pour câbles

ref. S8040



Separador vendido à parte
Divisoria se vende por separado
Spacer sold separately
Séparateur vendu séparément

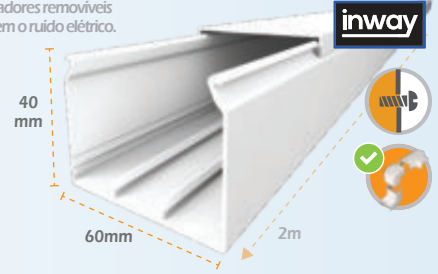

Compatible With:

8040B ref.



Calha 80x40 para cabos
Canaleta 80x40 para cables
Trunking 80x40 system for cables
Goulottes 80x40 pour câbles



ref. S8040

Separador vendido à parte
Divisoria se vende por separado
Spacer sold separately
Séparateur vendu séparément

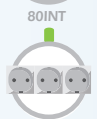
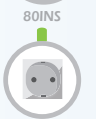

NEMA

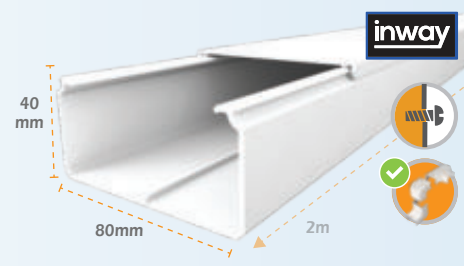

Compatible With:

10040B ref.



Calha 100x40 para cabos
Canaleta 100x40 para cables
Trunking 100x40 system for cables
Goulottes 100x40 pour câbles



ref. S10040

Separador vendido à parte
Divisoria se vende por separado
Spacer sold separately
Séparateur vendu séparément



NEMA

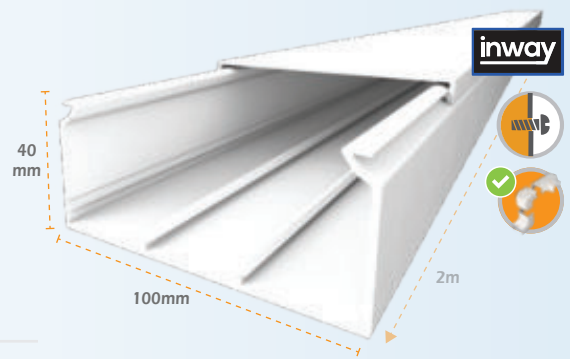

10054B ref.



Calha 100x54 para cabos e aparelhagem
Canaleta 100x54 para cables y mecanismos
Trunking 100x54 for cables, switches and sockets
Goulotte 100x54 pour câbles et appareillage



ref. S10040

Separador vendido à parte
Divisoria se vende por separado
Spacer sold separately
Séparateur vendu séparément

Direct click install!

45X90

45X45

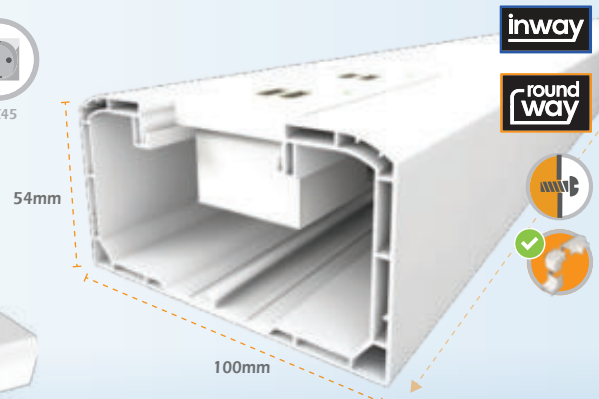

DIRECT FIT WITHOUT ACCESSORIES 1 CLICK DONE!

Compatível com aparelhagem 45x45 e 45x90 da JSL e universal tipo mosaica



Compatible with All JSL 45x45 and 45x90 and universal mosaic type sockets

Ref.	Dim. Ext. (mm)	Dim. Int. (mm)	Área (S)mm ²	Área Útil (SU)(S):1.2(mm) ²	Área Máx.	Nº Max Cabo 1,5 mm	Nº Max Cabo 2,5 mm	Nº Max Cabo 4 mm	Nº Max Cabo 6 mm	UTP CAT5e	UTP CAT6e	RG-6
6040B	60x40	57x38	2166	1408	38	138	90	72	44	44	40	38
8040B	80x40	76x38	2888	1877	38	190	120	96	58	58	48	44
10040B	100x40	97x44	4360	2840	44	258	166	138	84	84	78	74
10054B	100x54	2x(37x44)	3250	2100	37	232	146	104	88	62	54	28

ACESSÓRIOS PARA CALHA 10054 | ACCESORIOS PARA CANALETA 10054
 ACCESSORIES FOR 10054 TRUNKING | ACCESSOIRES POUR GOULOTTE 10054

Compatível com aparelhagem 45x45 e 45x90 da JSL e universal tipo mosaic

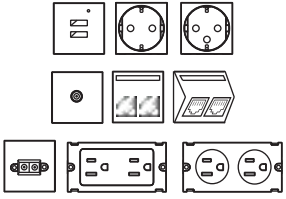

Compatible with All JSL 45x45 and 45x90 and universal mosaic type sockets

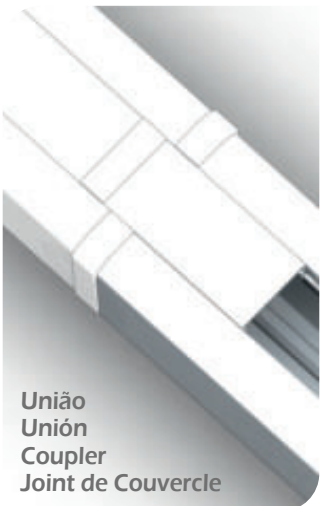
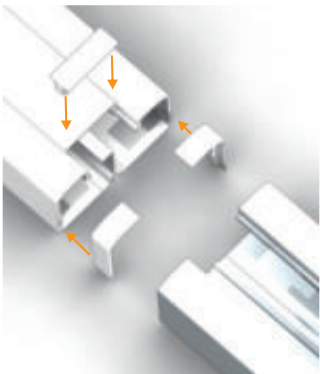

União
Unión
Coupler
Joint de Couvercle

inway 100 x 54



-  **Ângulo Interior**
 Angulo Interior
 Internal Bend
 Angle Intérieur
-  **Ângulo Plano**
 Angulo Plano
 Flat Bend
 Angle Plat
-  **Tampa Terminal**
 Tapa Final
 End Cap
 Embout
-  **Ângulo Externo**
 Angulo Externo
 External Bend
 Angle Extérieur
-  **Derivação em T**
 Derivación en T
 Tee
 Dérivation en T
-  **União**
 Unión
 Coupler
 Joint couvercle

Ângulo Interior | Angulo Interior
 Internal Bend | Angle Intérieur

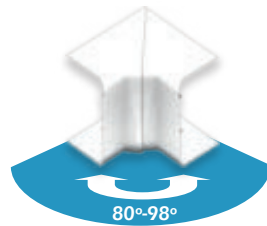

Amplitude para instalação de calhas entre 80° e 98°
 Amplitud para instalación de canaletas entre 80° y 98°
 Trunking installation amplitude between 80° and 98°
 Amplitude pour l'installation de goulottes entre 80° et 98°

Ângulo Exterior | Angulo Exterior
 External Bend | Angle Extérieur

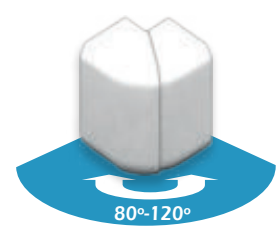

Amplitude para instalação de calhas entre 80° e 120°
 Amplitud para instalación de canaletas entre 80° y 120°
 Trunking installation amplitude between 80° and 120°
 Amplitude pour l'installation de goulottes entre 80° et 120°

Schuko / French style



Nema



ACESSÓRIOS PARA CALHA 8040 | ACCESORIOS PARA CANALETA 8040
ACCESSORIES FOR 8040 TRUNKING | ACCESSOIRES POUR GOULOTTE 8040

Compatível com aparelhagem 45x45 e 45x90 da JSL e universal tipo mosaic

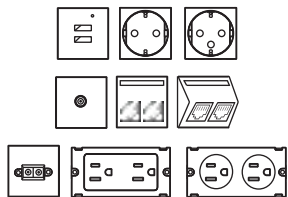

Compatible with All JSL 45x45 and 45x90 and universal mosaic type sockets



Schuko / French style

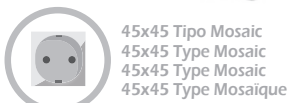

45x45 Tipo Mosaic
45x45 Type Mosaic
45x45 Type Mosaic
45x45 Type Mosaïque



90x45 Tipo Mosaic
90x45 Type Mosaic
90x45 Type Mosaic
90x45 Type Mosaïque



Nema



Tipo NEMA
Type NEMA
Type NEMA
Type NEMA



45x45 Tipo Mosaic
45x45 Type Mosaic
45x45 Type Mosaic
45x45 Type Mosaïque

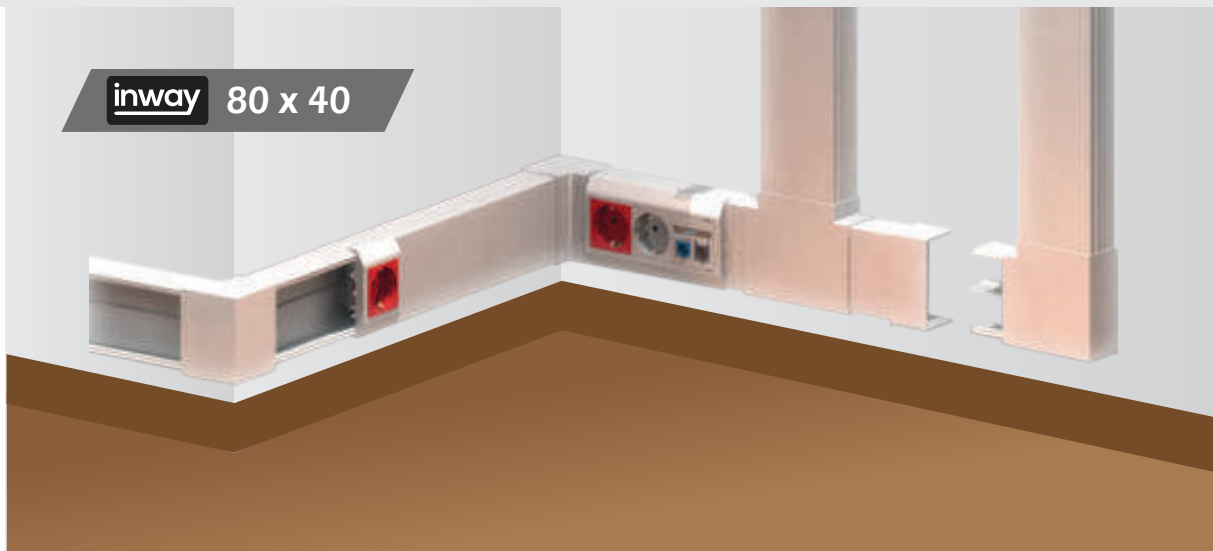

inway 80 x 40

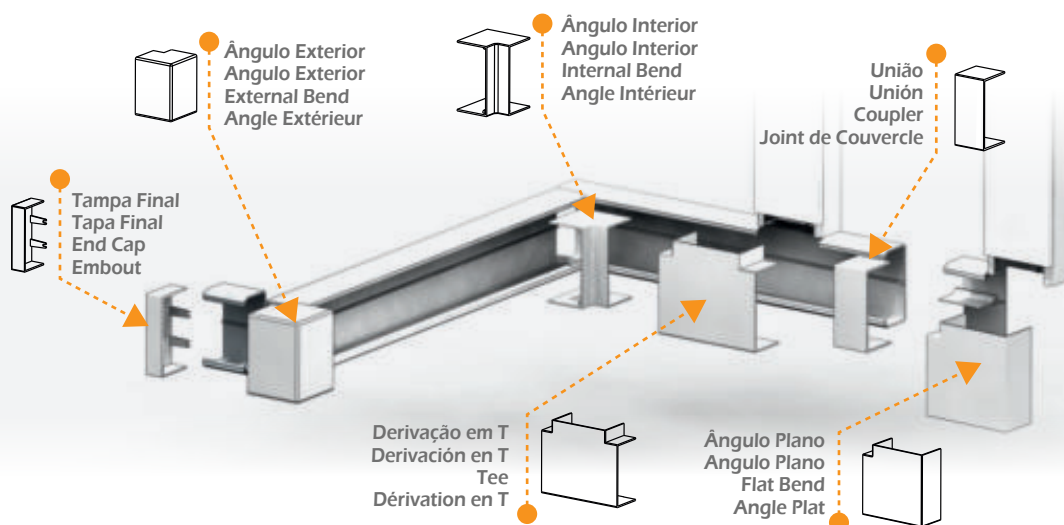

Schuko / French style

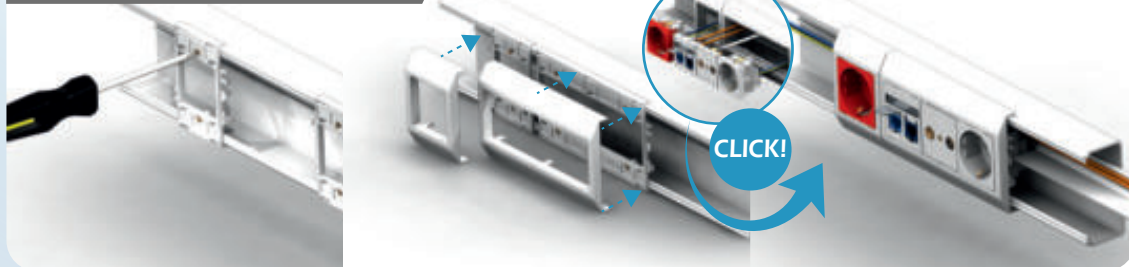

Nema

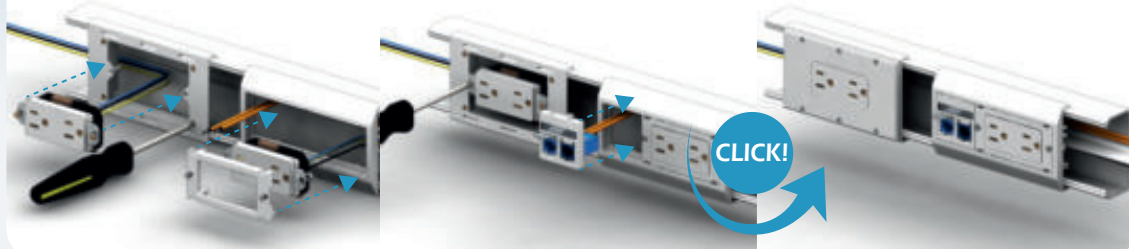

Acessórios para calhas Inway | Acesoios para Canaletas Inway Accessories for Inway Trunking | Accessoires pour Goulottes Inway



-5°C
+60°C



Blanco | Preto
Blanco | Negro
White | Black
Blanche | Noir



Termoplástico
Termoplastico
Thermoplastic
Thermoplastique



Aplicação por pressão
Aplicación presión
Pressure application
Application à pression



45x45 Tipo Mosaic
45x45 Type Mosaic
45x45 Type Mosaïque

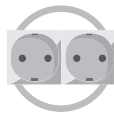

90x45 Tipo Mosaic
90x45 Type Mosaic
90x45 Type Mosaïque



Tipo NEMA
Type NEMA
Type NEMA
Type NEMA

45IN10 ref.

Caixa de aparelhagem 45x45
Caja para mecanismos 45x45
Box for sockets 45x45
Boîte Pour l'appareillage 45x45

Para usar com calha / to use with trunking :



2010B ref.



3010B ref.



45IN10D ref.

Caixa dupla de apar. 45x45 & 45x90
Caja double p. mecanismos 45x45 & 45x90
Double Box for sockets 45x45 & 45x90
Boîte Double Pour l'appar. 45x45 & 45x90

Para usar com calha / to use with trunking :



2010B ref.



3010B ref.



45IN17 ref.

Caixa de aparelhagem 45x45
Caja para mecanismos 45x45
Box for sockets 45x45
Boîte Pour l'appareillage 45x45

Para usar com calha / to use with trunking :



2517B ref.



4017B ref.



45IN17D ref.

Caixa dupla de apar. 45x45 & 45x90
Caja double p. mecanismos 45x45 & 45x90
Double Box for sockets 45x45 & 45x90
Boîte Double Pour l'appar. 45x45 & 45x90

Para usar com calha / to use with trunking :



2517B ref.



4017B ref.

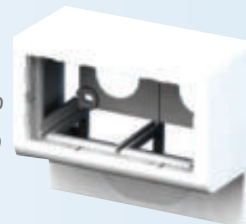

POSTOS DE TRABALHO



MINI POSTOS DE TRABALHO
CAIXAS DE PAREDE | CAIXAS DE CHÃO



SCAN + INFO



-5°C
+60°C



Branco e vermelho
Blanco y rojo
White and red
Blanche et rouge



Termoplástico
Termoplastico
Thermoplastic
Thermoplastique



Aplicação por pressão
Aplicación presión
Pressure application
Application à pression



Fixação por parafusos
Fijacion por tornillos
Fixing by screws
Fixation par des vis



Tipo NEMA
Type NEMA
Type NEMA
Type NEMA



SCAN + INFO

80INS ref.

Espelho simples p. aparelhagem 45x45
Marco simple para mecanismos 45x45
Single frame for sockets 45x45
Plaque simple pour l'appareillage 45x45



Para usar com calha / to use with trunking :



8040B ref.

80INT ref.

Espelho triplo p. aparelhagem 45x45
Marco triple para mecanismos 45x45
Triple frame for sockets 45x45
Plaque triple pour l'appareillage 45x45

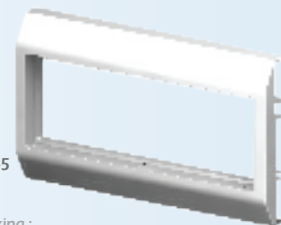

Para usar com calha / to use with trunking :



8040B ref.

80INi ref.

100INi ref.

Espelho duplo p. aparelhagem NEMA
Marco double para mecanismos NEMA
Double frame for NEMA sockets
Plaque double pour l'appareillage NEMA



Para usar com calha / to use with trunking :



80INi ref.



8040B ref.



100INi ref.



10040B ref.

S8040 ref.

Separador para calha
Divisoria para canaleta
Spacer for trunking
Séparateur pour goulotte



Para usar com calha / to use with trunking :



8040B ref.

6040B ref.

10040B ref.

S10040 ref.

Separador para calha
Divisoria para canaleta
Spacer for trunking
Séparateur pour goulotte



Para usar com calha / to use with trunking :



10054B ref.

100ESP ref.

Espaçador para calha e fixador aparelhagem
Divisoria para canaleta fija y fijación de los mecanismos
Spacer for trunking and socket fixation
Séparateur pour goulotte et fixation do appareillage



Para usar com calha / to use with trunking :



10040B ref.

NEM-BR ref.

Accesó. p tomada NEMA
Aceso. p. Toma NEMA
Acces. for Nema Sockets
Acesso. p. Prise NEMA



Para usar com calha / to use with trunking :



10054B ref.



NEMA



NEM-EAG-BR ref.

Accesó. p tomada NEMA
Aceso. p. Toma NEMA
Acces. for Nema Sockets
Acesso. p. Prise NEMA



Para usar com calha / to use with trunking :



10054B ref.



NEMA



NEM-EN ref.

Accesó. p tomada NEMA
Aceso. p. Toma NEMA
Acces. for Nema Sockets
Acesso. p. Prise NEMA



Para usar com calha / to use with trunking :



10054B ref.



NEMA



NEM-EAG-EN ref.

Accesó. p tomada NEMA
Aceso. p. Toma NEMA
Acces. for Nema Sockets
Acesso. p. Prise NEMA



Para usar com calha / to use with trunking :



10054B ref.



NEMA



ACESSÓRIOS PARA APARELHAGEM (Mini Canal) | ACCESORIOS PARA MECANISMOS (Mini Canal)
 ACCESSORIES FOR SWITCHES AND SOCKETS (Mini Trunking) | ACESSOIRES POUR APPAREILLAGE

Compatível com aparelhagem 45x45 e 45x90 da JSL e universal tipo mosaic

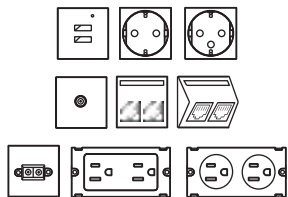

Compatible with All JSL 45x45 and 45x90 and universal mosaic type sockets

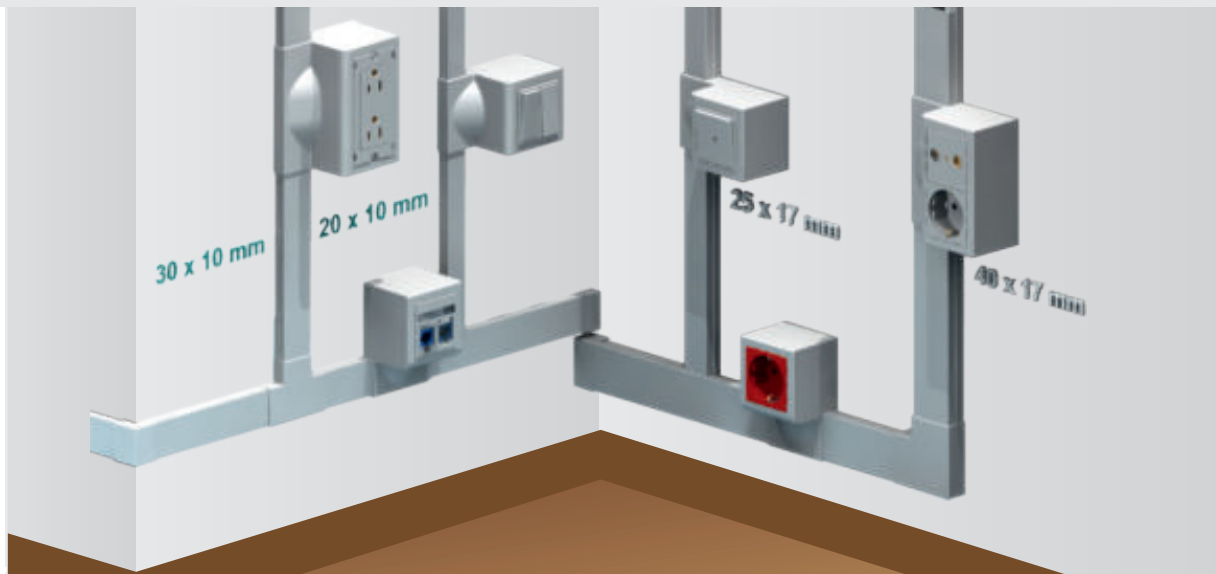

Preparação para utilização em calha 20 x 10 mm ou 25 x 17 mm
 Preparación para canaleta 20 x 10 mm o 25 x 17 mm
 Setting for trunking 20 x 10 mm or 25 x 17 mm
 Préparation pour goulotte 20 x 10 mm ou 25 x 17 mm

Preparação para utilização em calha 30 x 10 mm ou 40 x 17 mm
 Preparación para canaleta 30 x 10 mm o 40 x 17 mm
 Setting for trunking 30 x 10 mm or 40 x 17 mm
 Préparation pour goulotte 30 x 10 mm ou 40 x 17 mm

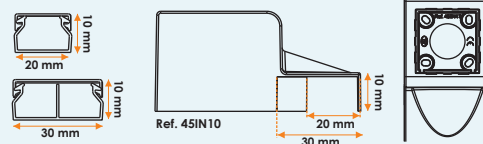
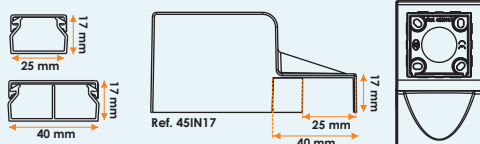
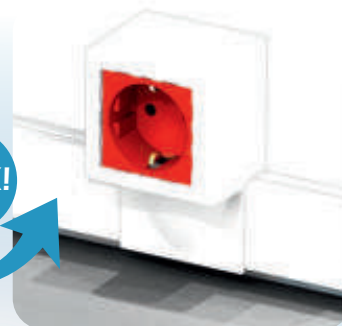
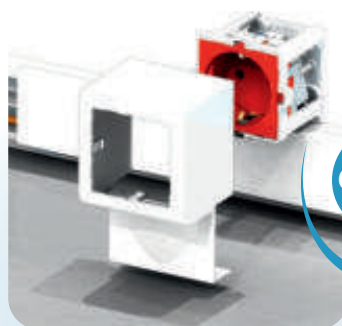
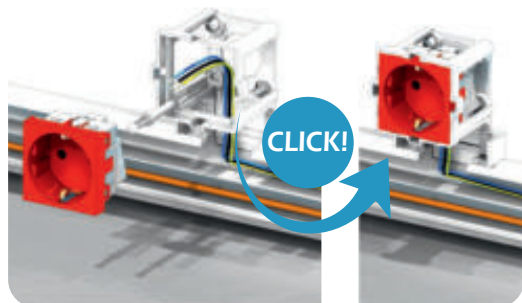
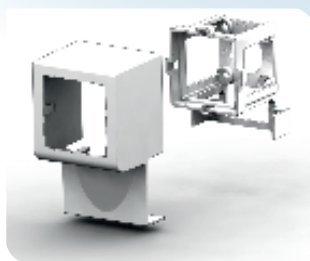

IP 41

IK 08

Cinza | Branco
Gris | Blanco
Gray | White
Gris | Blanc

Termoplástico
Termoplastic
Thermoplastic
Thermoplastique

Aplicação por pressão
Aplicación presión
Pressure application
Application à pression

Recebe Aparelh. c/ (access.)
Recibe Mecannis. c/(access.)
Reciev. Sock. (using access.)
Install. (avec des access.)

Fixação por parafusos
Fijacion por tornillos
Fixing by screws
Fixation par des vis

80 x 80

Accesórios (Pág. 36)
Accesorios (Pág. 36)
Available (Pag. 36)
Accessoires (Pag. 36)

Calha de chão | Canaleta de suelo
Over floor trunking | Passage de plancher

7018 ref.

Calha de chão
Canaleta de suelo
Over floor trunking
Passage de plancher

Para usar com / to use with:
TR7018 ref. Torre de chão
Overfloor tower

AD7020 ref.

Adaptador para calha de rodapé 7020
Adaptador para Canaleta de rodapie 7020
Adapter for Bottom wall trunking 7020
Adaptateur pour goulottes murales 7020

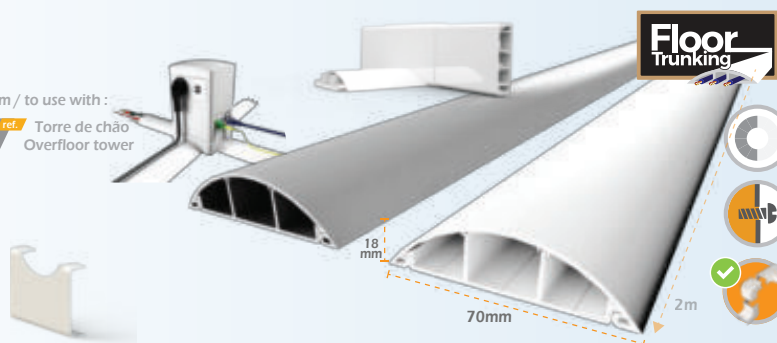

Acessórios para Calha de chão | Accesorios para Canaleta de suelo
Accessories for Over floor trunking | Accessoires pour Passage de plancher

GR7018 ref.

Derivação em T e Cruzamento
Derivación en T e Cruce
T Derivation and Crossing
Dérivation en T et Traversée



AP7018 ref.

Ângulo Plano 70x18
Ángulo Plano 70x18
Flat Bend 70x18
Angle Plat 70x18

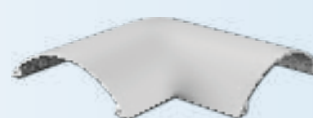

GU7018 ref.

União 70x18
Unión 70x18
Coupler 70x18
Joint couvercle 70x18



AD7020 ref.

Adaptador para calha de rodapé 7020
Adaptador para Canaleta de rodapie 7020
Adapter for Bottom wall trunking 7020
Adaptateur pour goulottes murales 7020



Calha de rodapé | Canaleta de rodapie
Bottom wall trunking | Goulotte murale

7020B ref.

Calha de rodapé
Canaleta rodapie
Bottom wall trunking
Goulotte murale

Compatible With:
873IN20 873TC20

AD7020 ref.

Adaptador para calha de rodapé 7020
Adaptador para Canaleta de rodapie 7020
Adapter for Bottom wall trunking 7020
Adaptateur pour goulottes murales 7020

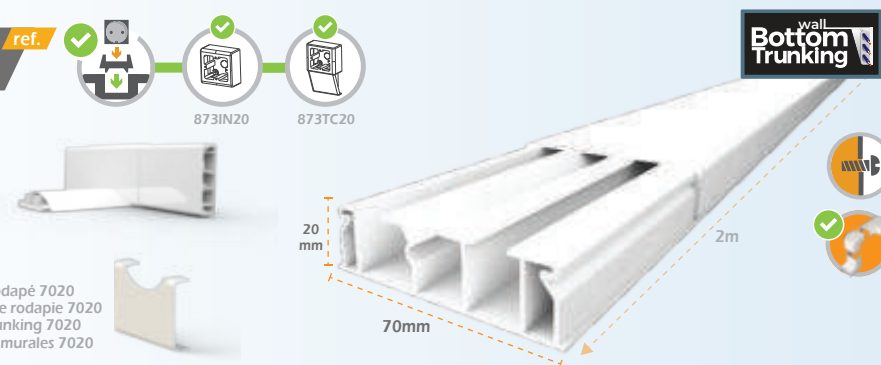

Acessórios para Calha de rodapé | Accesorios para Canaleta rodapie
Accessories for Bottom wall trunking | Accessoires pour Goulotte murale

873-IN20 ref.

Caixa de aparelhagem
Caja para mecanismos
Box for appliances
Boite pour l'appareillage



80x80

Para usar com calha / to use with trunking



873-TC20 ref.

Caixa de aparelhagem
Caja para mecanismos
Box for appliances
Boite pour l'appareillage



80x80

Para usar com calha / to use with trunking



SCAN + INFO

Ref.	Dim. Ext. (mm)	Dim. Int. (mm)	Área (S)mm ²	Área Útil (Su)(S): 1.2(mm) ²	Área Máx.	Nº Max Cabo 1,5 mm	Nº Max Cabo 2,5 mm	Nº Max Cabo 4 mm	Nº Max Cabo 6 mm	UTP CAT5e	UTP CAT6e	RG-6
7018	70x18	53x15,5	155-274-155	100-180-100	15	150	8-16-8	5-10-5	4-7-4	3-6-3	-	-
7020B	70x20	68x18	255-272-221	-	15-16-13	17-18-14	11-12-10	9-9-8	5-5-4	-	-	-



7018

ref.

7020B

ref.

873-TC20

ref.

873-IN20

ref.

AD7020

ref.

GR7018

ref.

GU7018

ref.

AP7018

ref.



1



2



3



4



5



6

Ecosistema de produtos integrados

Integrated Product Ecosystem



2

3



Acessórios de acabamento completos 7020b

Complete finishing accessories for 7020b

6



4

5

UTILIZAÇÃO DE ACESSÓRIO 873IN20 E 873-TC20 | UTILIZACIÓN DE ACCESORIOS 873IN20 Y 873-TC20
 873IN20 AND 873-TC20 ACCESSORY USE | UTILISATION DE L'ACCESSOIRE 873IN20 E 873-TC20

Compatível com todas as
 aparelhagens 80 x 80 mm

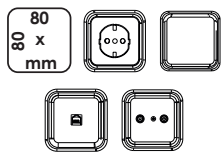

Compatible with all switches
 and sockets 80 x 80 mm



Preparação para utilização em calha 70 x 20 mm 873IN20
 Preparación para canaleta 70 x 20 mm 873IN20
 Setting for trunking 70 x 20 mm 873IN20
 Préparation pour goulotte 70 x 20 mm 873IN20

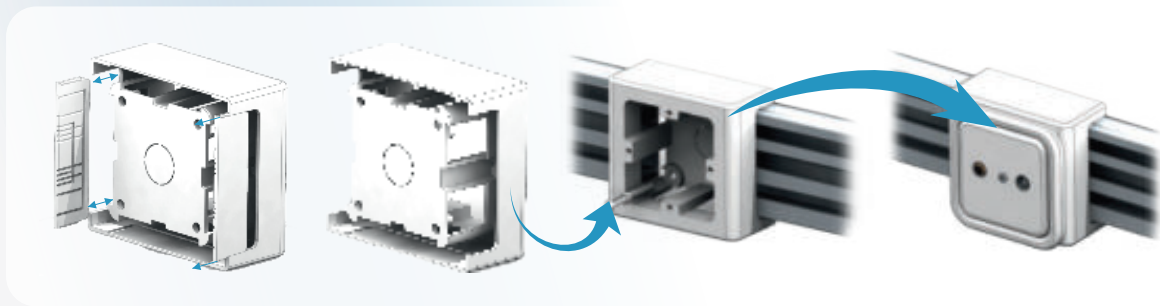

Preparação para utilização em diferentes medidas de minicanais
 Preparación para utilización en diferentes Canaletas
 Setting for different sizes of trunking
 Préparation pour différents dimensions de goulottes

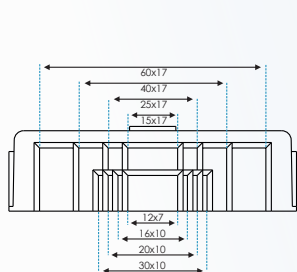

Montagem com caixa com pedestal Ref. 873-TC20
 Montaje con caja Ref. 873-TC20
 Assembly with box Ref. 873-TC20
 Assemblage avec boîte Ref. 873-TC20



Calhas para tubagem de fluidos | Canaletas para tuberia de fluidos
Trunking system for fluid pipes | Goulottes pour tuyaux de fluides

IP 41

IK 07

Branco
Blanco
White
Blanche

Termoplástico
Termoplastico
Thermoplastic
Thermoplastique

Aplicação por pressão
Aplicación presión
Pressure application
Application à pression

Agrupável
Apilable
Stackable
Empilable

Ajustável
Ajustable
Adjustable
Règlable

Accesórios (Pág. 36)
Accesorios (Pág. 36)
Available (Pag. 36)
Accessoires (Pag. 36)



T3535 ref.

Para instalar sem base de calha com abraçadeira:
To install without trunking base with the saddle:



Tampa 35X35 para tubagem de fluidos e gás doméstico
Tapa 35X35 para tuberia de fluidos y gas doméstico
35x35 Cover system for fluid pipes and domestic gas
Couvercle 35x35 pour tuyaux de fluides et gaz domestique

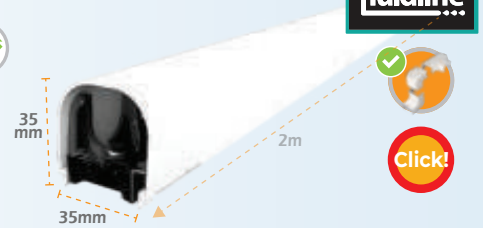

T7040 ref.

Para instalar sem base de calha com abraçadeira:
To install without trunking base with the saddle:



Tampa 70x40 para tubagem de fluidos
Tapa 70x40 para tuberia de fluidos
70x40 Cover system for fluid pipes
Couvercle 70x40 pour tuyaux de fluides

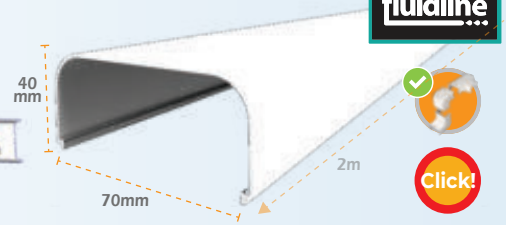

T7040-Plus ref.

Instalação sem recurso a base de calha, com abraçadeira:
To install without trunking base, using the saddle:



Tampa 70x45 para tubagem de fluidos
Tapa 70x45 para tuberia de fluidos
70x45 Cover system for fluid pipes
Couvercle 70x45 pour tuyaux de fluides

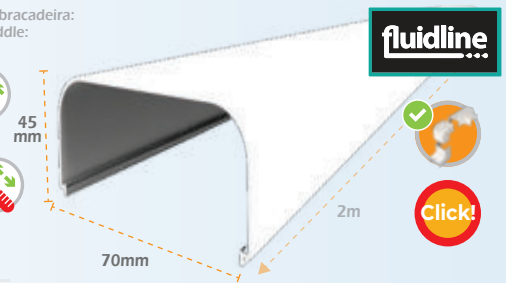

T7060 ref.

Para instalar sem base de calha com abraçadeira:
To install without trunking base with the saddle:



Tampa 70x60 para tubagem de fluidos
Tapa 70x60 para tuberia de fluidos
70x60 Cover system for fluid pipes
Couvercle 70x60 pour tuyaux de fluides

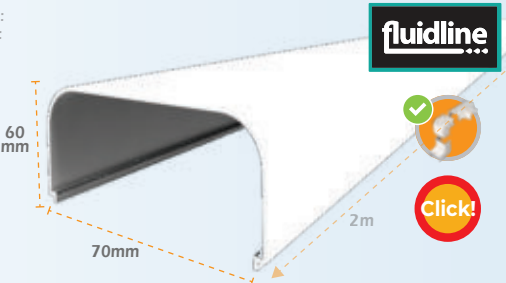

T10060 ref.

Para instalar sem base de calha com abraçadeira:
To install without trunking base with the saddle:



Tampa 120x60 para tubagem de fluidos
Tapa 120x60 para tuberia de fluidos
120x60 Cover system for fluid pipes
Couvercle 120x60 pour tuyaux de fluides

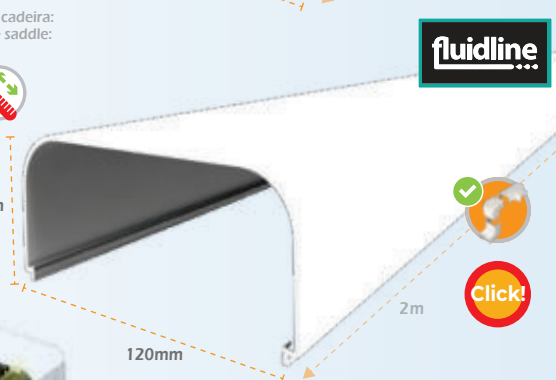

Ref.	Dim.Ext. (mm)	ØA (Pol)	ØA (mm)
T3535	35x35	1/4 - 3/8 - 7/8	13,5 - 17,2 - 21,3

Distância aproximada | Distancia recomendada
Recommended distance | Distance recommandée

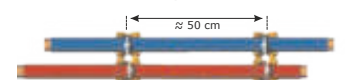

Ref.	Dim. Ext. (mm)	Dim. Int. (mm)	Área (S)mm ²	Área Útil (Su)(S):1.2(mm) ²	Área Máx.	Nº Max Cabo 1,5 mm	Nº Max Cabo 2,5 mm	Nº Max Cabo 4 mm	Nº Max Cabo 6 mm	UTP CAT5e	UTP CAT6e	RG-6
T7040	70x40	70x33	2310	1500	32	150	100	78	44	44	40	38
T7040-Plus	70x45	70x42	2940	1900	40	195	135	102	58	58	55	53
T7060	70x60	70x56	3920	2550	50	256	178	135	76	76	72	68
T10060	120x60	116x56	6500	4200	50	425	396	225	130	130	125	112



SCAN + INFO

Bases para calhas Fluidline | Bases para canaletas Fluidline
Bottom for Fluidline Trunking | Base pour Goulottes Fluidline

IP 41

IK 07

Branco
Blanco
White
Blanche

Termoplástico
Termoplastico
Thermoplastic
Thermoplastique

Aplicação por pressão
Aplicación presión
Pressure application
Application à pression

Fixação por parafusos
Fijación por tornillos
Fixing by screws
Fixation par des vis

✓
Acessórios (Pág. 36)
Accesorios (Pág. 36)
Available (Pag. 36)
Accessoires (Pag. 36)

Concepção
Diseño
Design
Conception



B7040 ref.

Base para Calha Fluidline 70x40
Bases para canaletas Fluidline 70x40
Bottom for Fluidline Trunking 70x40
Base pour Goulottes Fluidline 70x40

Para usar com tampa / to use with cover:

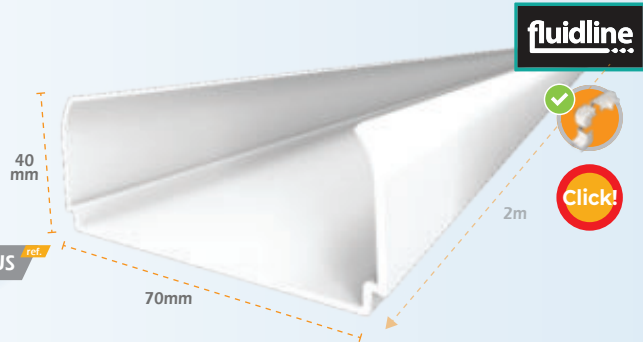

B7060 ref.

Base para Calha Fluidline 70x60
Bases para canaletas Fluidline 70x60
Bottom for Fluidline Trunking 70x60
Base pour Goulottes Fluidline 70x60

Para usar com calha / to use with trunking :

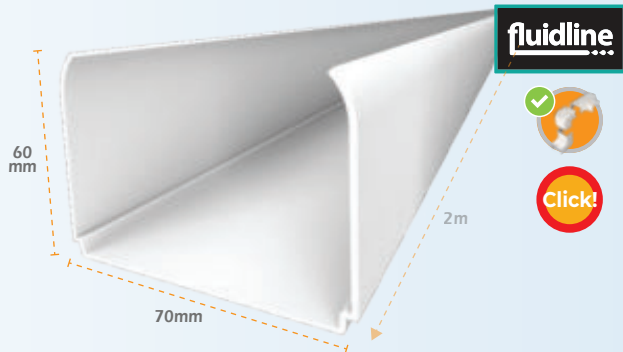

B10060 ref.

Base para Calha Fluidline 120x60
Bases para canaletas Fluidline 120x60
Bottom for Fluidline Trunking 120x60
Base pour Goulottes Fluidline 120x60

Para usar com calha / to use with trunking :

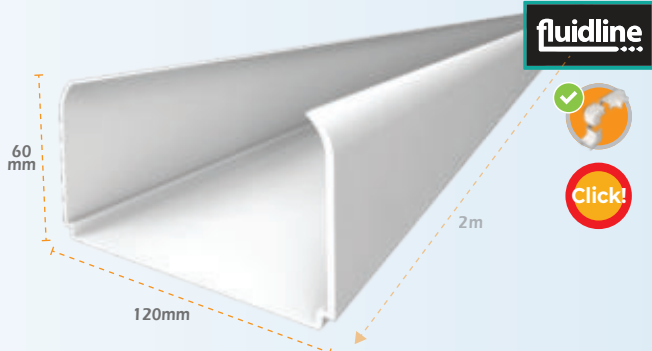

Ref.	Dim. Ext. (mm)	Dim. Int. (mm)	Área (S)mm ²	Área Útil (Su)S)-1.2[(mm) ²	Área Máx.	Nº Max Cabo 1,5 mm	Nº Max Cabo 2,5 mm	Nº Max Cabo 4 mm	Nº Max Cabo 6 mm	UTP CAT5e	UTP CAT6e	RG-6
B7040	70x40	70x33	2310	1500	32	150	100	78	44	44	40	38
B7060	70x60	70x56	3920	2550	50	256	178	135	76	76	72	68
B10060	120x60	116x56	6500	4200	50	425	396	225	130	130	125	112



SCAN + INFO



FIDELIDADE
DIFERENÇA INOVAÇÃO
VERSATILIDADE
FABRICADA EM PORTUGAL

Acessórios para calhas Fluidline | Acesoios para Canaletas Fluidline
Accessories for Fluidline Trunking | Accessoires pour Goulottes Fluidline

IP 41

IK 07

Branco
Blanco
White
Blanche

Termoplástico
Termoplastico
Thermoplastic
Thermoplastique

Aplicação por pressão
Aplicación presión
Pressure application
Application à pression

Fixação por parafusos
Fijación por tornillos
Fixing by screws
Fixation par des vis

Agrupável
Apilable
Stackable
Empilable

Ajustável
Ajustable
Adjustable
Réglable

Accesórios (Pág. 36)
Accesorios (Pág. 36)
Available (Pag. 36)
Accessoires (Pag. 36)



4014 ref.

Abracadeira para tubos de água e gás
Abrazadera para tuberías de agua y gas
Saddle for water and gas pipes
Attache pour tubes de l'eau et gaz

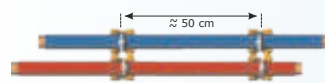

Ø Ext.	
ØA (Pol)	ØA (mm)
1/4	13,5
3/8	17,2
7/8	21,3

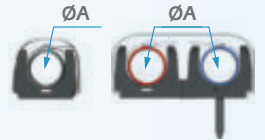

4015 ref.

Abracadeira ajustável para tubos
Abrazadera ajustable para tubos
Adjustable Saddle for pipes
Attache réglable pour tubes



GT7040E1 ref.

Derivação em T para curva de água
Derivación en T para curva de agua
Tee for water bend
Déivation en T pour la courbe de l'eau



RT10040F ref.

Redutor
Reductor
Reducer
Réducteur



4012 ref.

Caixa com tampa pré-instalado de Ar Condicionado
Caja con tapa de aire acondicionado preinstalada
Flush mounting Box with pre-installed Air Conditioning Cover
Boite avec couvercle de climatisation préinstallé

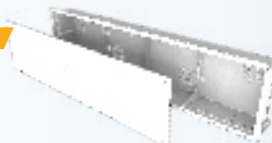

4011 ref.

Caixa com tampa p/ + sifão reversível AC
Caja con tapa + desague Réversible para AC
Box with lid + Reversible siphon for Air Conditioning
Boite avec couvercle + Réversible sortie de l'eau pour AC

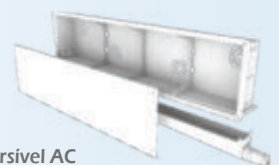

4013 ref.

Sifão Reversível para caixa 4012
Desague Réversible para Caja 4012
Reversible Siphon for 4012 Box
Réversible Sortie de l'eau pour boîte 4012



4018 ref.

União 90°
Unión 90°
Joint 90°
Joint 90°



4020 ref.

União
Unión
Joint
Joint



4019 ref.

Derivação
Derivación
Tee
Déivation



SCAN + INFO

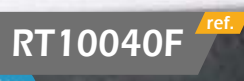
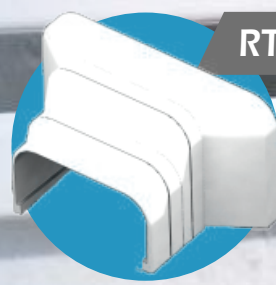
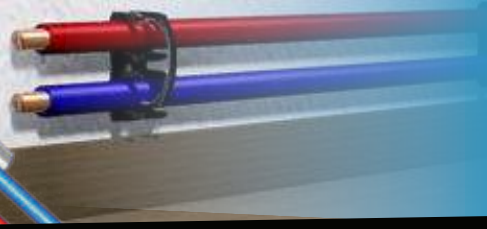
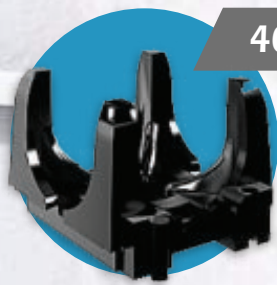
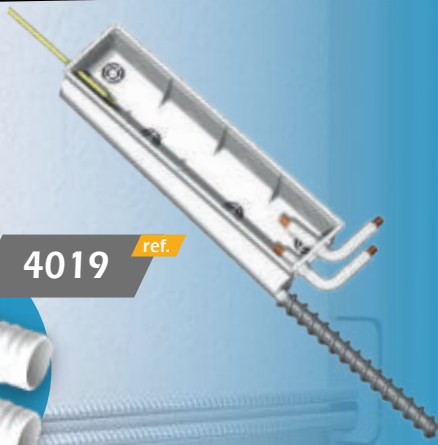
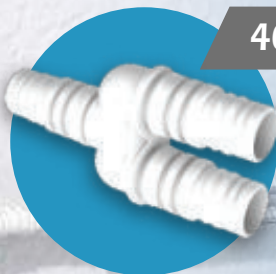
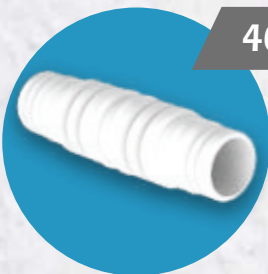

Calha com cantos arredondados | Canaletas con cantos redondeados
Trunking with rounded corners | Goulottes avec coins arrondis

IP 41

IK 07

Branco
Blanco
White
Blanche

Termoplástico
Termoplastic
Thermoplastic
Thermoplastique

Aplicação por pressão
Aplicación presión
Pressure application
Application à pression

Fixação por parafusos
Fijación por tornillos
Fixing by screws
Fixation par des vis

✓ Acessórios (Pág. 36)
Accesorios (Pág. 36)
Available (Pag. 36)
Accessoires (Pag. 36)

Concepção
Diseño
Design
Conception



B7040 ref. + **T7040** ref.

Calha de cantos arredondados 70x40 para cabos
Canaleta líneas redondeadas 70x40 para cables
Round lines 70x40 Trunking system Cables
Goulotte de lignes rondes 70x40 pour les cables

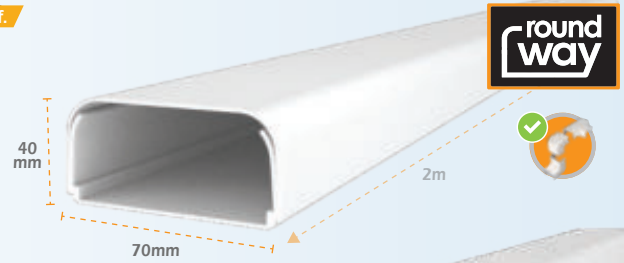

B7040 ref. + **T7040-Plus** ref.

Calha de cantos arredondados 70x45 para cabos
Canaleta líneas redondeadas 70x45 para cables
Round lines 70x45 Trunking system Cables
Goulotte de lignes rondes 70x45 pour les cables

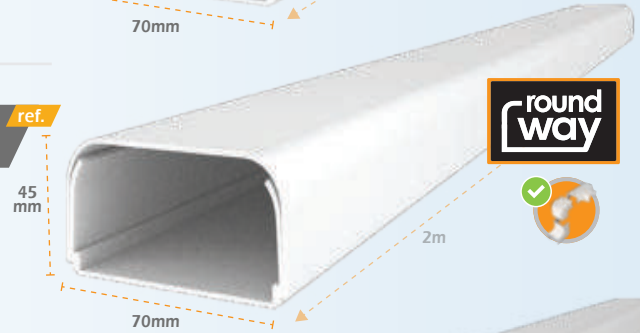

B7060 ref. + **T7060** ref.

Calha de cantos arredondados 70x60 para cabos
Canaleta líneas redondeadas 70x60 para cables
Round lines 70x60 Trunking system Cables
Goulotte de lignes rondes 70x60 pour les cables

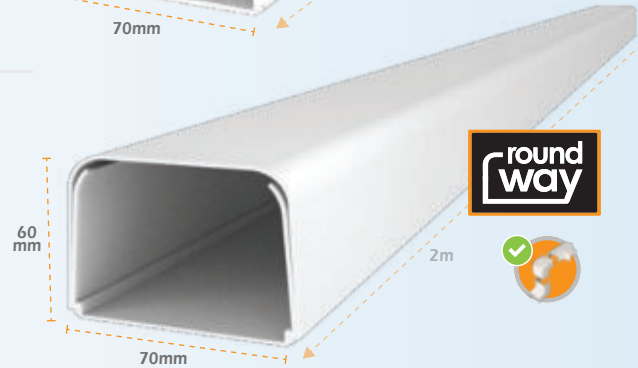

10054B ref. ✓

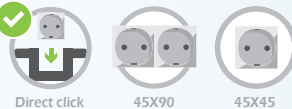

Calha de cantos arredondados 100x54 para cabos e aparelhagem
Canaleta líneas redondeadas 100x54 para cables y mecanismos
Round lines 100x54 Trunking system Cables
Goulotte de lignes rondes 100x54 pour les cables et appar.

pag 23 Acessórios página | Accesorios página
Accessories page | Page accessoires

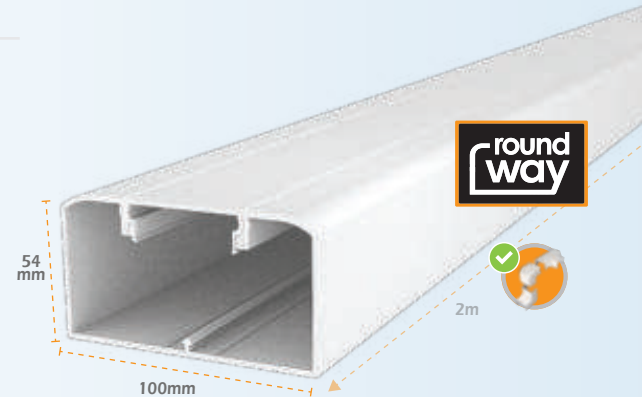

B10060 ref. + **T10060** ref.

Calha de cantos arredondados 120x60 para cabos
Canaleta líneas redondeadas 120x60 para cables
Round lines 120x60 Trunking system Cables
Goulotte de lignes rondes 120x60 pour les cables

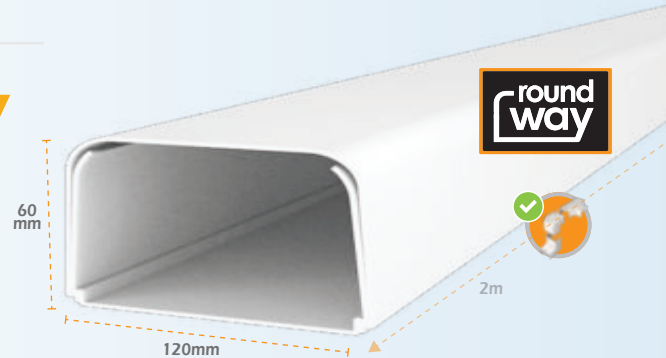

Ref.	Dim. Ext. (mm)	Dim. Int. (mm)	Área (S)mm ²	Área Útil (Su) (S):1.2(mm) ²	Área Máx.	Nº Max Cabo 1,5 mm	Nº Max Cabo 2,5 mm	Nº Max Cabo 4 mm	Nº Max Cabo 6 mm	UTP CAT5e	UTP CAT6e	RG-6
B7040+T7040	70x40	70x33	2310	1500	32	150	100	78	44	44	40	38
B7040+T7040-Plus	70x45	70x42	2940	1900	40	195	135	102	58	58	55	53
B7060+T7060	70x60	70x56	3920	2550	50	256	178	135	76	76	72	68
B10060+T10060	120x60	116x56	6500	4200	50	425	396	225	130	130	125	112
10054B	100x54	2x(28x48)	1360	880	28	85	60	44	25	25	22	20



SCAN + INFO

100X54LH

100% HALOGEN FREE TECHNICAL
CABLE TRUNKING SYSTEM

CALHA TÉCNICA 100%
LIVRE DE HALOGENEOS



RECEBE APARELHAGEM DIRETAMENTE
45X45 E 45X90

RECEIVES DIRECTLY 45X45 & 45X90
SWITCHES & SOCKETS

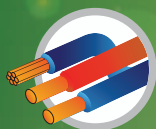

TO USE WITH:
CABLES, SWITCHES
& SOCKETS

USAR COM:
CABOS, INTERRUPTORES
& TOMADAS



DIRECT FIT
WITHOUT
ACCESSORIES

ENCAIXE
DIRECTO
SEM ACESSÓRIOS

NEW MATERIAL = NEW DESIGN
INTERNAL WALL STRUCTURE REINFORCED

MATERIAL NOVO = NOVO DESIGN
ESTRUTURA DA PAREDE INTERNA REFORÇADA



Adaptable and innovative, ready to receive 45x45 & 45x90 switches and sockets directly, without the need of additional fixing accessories. There are also accessories available for installing NEMA American switches and sockets (45x90).

Adaptável e inovadora, pronta para receber diretamente aparelhagem 45x45 e 45x90, sem a necessidade de acessórios adicionais de fixação. Disponibilizamos também acessórios para instalar Interruptores e tomadas americanas NEMA (45x90).

COMPLETE RANGE OF
100% HALOGEN FREE
ACCESSORIES

GAMA COMPLETA DE
ACESSÓRIOS DE ACABAMENTO
100% LIVRES DE HALOGENEO



WWW.JSL-ONLINE.NET

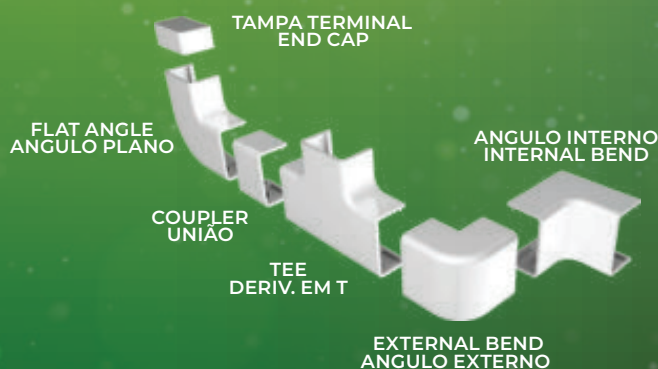

APARELHAGEM

Mecanismos
Switches and sockets
Appareillage

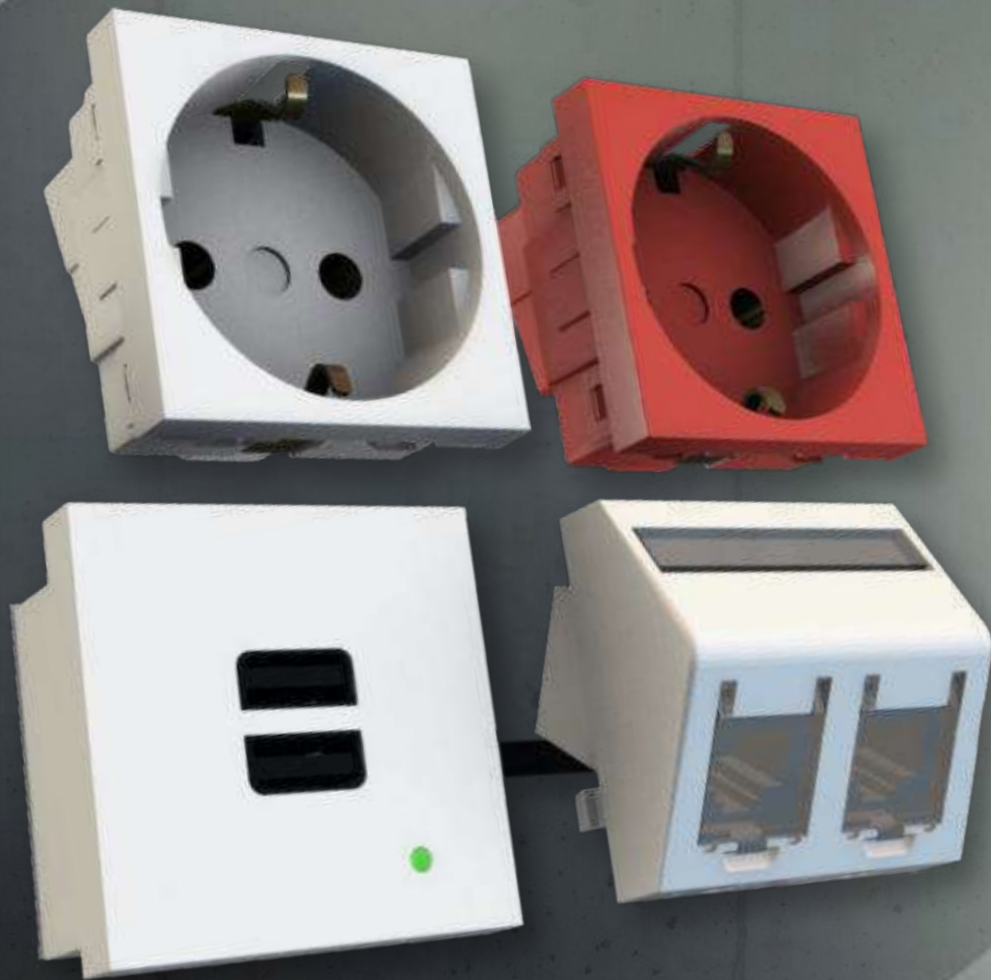

NOVO
NEW

quickvoltage

INSTANTLY CONNECTED
45x45 universal mosaic type sockets



Termoplástico
Termoplastico
Thermoplastic
Thermoplastique



-5°C
+60°C

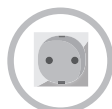

45x45 Tipo Mosaic
45x45 Type Mosaic
45x45 Type Mosaic
45x45 Type Mosaïque



Branco | Preto | Vermelho
Blanco | Negro | Rojo
White | Black | Red
Blanc | Noir | Rouge



As referências "745" estão disponíveis nos acabamentos standard Branco e Preto. A gama inclui também uma versão em Vermelho, concebida para a identificação visual de circuitos protegidos ou de emergência (SAI/UPS).

Las referencias "745" están disponibles en los acabados estándar Blanco y Negro. La gama incluye también una versión en Rojo, diseñada para la identificación visual de circuitos protegidos o de emergencia (SAI/UPS).

The "745" references are available in standard White and Black finishes. The range also includes a Red version, designed for the visual identification of protected or emergency circuits (UPS).

Les références "745" sont disponibles dans les finitions standard Blanc et Noir. La gamme comprend également une version en Rouge, conçue pour l'identification visuelle des circuits protégés ou de secours (SAI/UPS).



RoHS



REACH



SCAN + INFO

USB-21 ^{ref.}

21W

USB 5V 4.2A

Carregador USB Duplo (A+C) 21W (5V/4.2A)
Cargador USB Doble (A+C) 21W (5V/4.2A)
Dual USB Charger (A+C) 21W (5V/4.2A)
Chargeur USB Double (A+C) 21W (5V/4.2A)



USB-A & USB-C

Ref.	Para - For - Pour	Dim. (mm)
USB-21-BR USB-21-PR	Calha Técnica e Postos de Trabalho Canal Técnico y Puestos de Trabajo Cable Trunking and Workstations Goulottes Techniques et Postes de Travail	45x45

745-1 ^{ref.}

FAST CONNECT

Tomada Simples Schuko 16 A/250V 2P+T
Toma Simple Schuko 16 A/250V 2P+T
Single Schuko Socket 16 A / 250V 2P+E
Prise Simple Schuko 16 A / 250V 2P+T



Ref.	Para - For - Pour	Dim. (mm)
745-1-BR 745-1-PR 745-1-EN	Calha Técnica e Postos de Trabalho Canal Técnico y Puestos de Trabajo Cable Trunking and Workstations Goulottes Techniques et Postes de Travail	45x45

745-2 ^{ref.}

FAST CONNECT

Tomada Dupla Schuko 16 A/250V 2P+T
Toma Doble Schuko 16 A / 250V 2P+T
Double Schuko Socket 16 A / 250V 2P+E
Prise Double Schuko 16 A / 250V 2P+T



Ref.	Para - For - Pour	Dim. (mm)
745-2-BR 745-2-PR 745-2-EN	Calha Técnica e Postos de Trabalho Canal Técnico y Puestos de Trabajo Cable Trunking and Workstations Goulottes Techniques et Postes de Travail	45x45

745-3 ^{ref.}

FAST CONNECT

Tomada Tripla Schuko 16 A/250V 2P+T
Toma Triple Schuko 16 A / 250V 2P+T
Triple Schuko Socket 16 A / 250V 2P+E
Prise Triple Schuko 16 A / 250V 2P+T



Ref.	Para - For - Pour	Dim. (mm)
745-3-BR 745-3-PR 745-3-EN	Calha Técnica e Postos de Trabalho Canal Técnico y Puestos de Trabajo Cable Trunking and Workstations Goulottes Techniques et Postes de Travail	45x45

Mini postos de trabalho JSL



A DUPLA PERFEITA

Para calhas minicanal JSL
20x10 30x10 25x17 40x17



Termoplástico
Termoplastico
Thermoplastic
Thermoplastique



-5°C
+60°C



45x45 Tipo Mosaic
45x45 Type Mosaic
45x45 Type Mosaic
45x45 Type Mosaic



Branco
Blanco
White
Blanc

745-LAN ^{ref.}

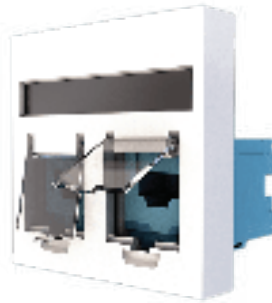

Tomada Dupla Lisa RJ45 Cat 6
Base double lisa RJ45 Cat 6
RJ45 Cat 6 socket
Socle de communication double RJ45 Cat 6

745-AMP ^{ref.}



Espelho liso RJ45 Cat 6
Marco lisa RJ45 Cat 6
Single frame RJ45 Cat 6 socket
Plaque simple pour socle de communication RJ45 Cat 6

Ref.	Para - For - Pour	Dim. (mm)
745-LAN 745-AMP	Calha Técnica e Postos de Trabalho Canal Técnico y Puestos de Trabajo Cable Trunking and Workstations Goulottes Techniques et Postes de Travail	45x45

745-LAN-ANG ^{ref.}



Tomada Dupla angular RJ45 Cat 6
Base double angular RJ45 Cat 6
Double RJ45 Cat 6 angular socket
Socle de communication double angulaire RJ45 Cat 6

745-AMP-ANG ^{ref.}



Espelho Dupla angular RJ45 Cat 6
Marco double angular RJ45 Cat 6
Single frame RJ45 Cat 6 angular socket
Plaque simple pour socle de communication double angulaire RJ45 Cat 6

Ref.	Para - For - Pour	Dim. (mm)
745-LAN-ANG 745-AMP-ANG	Calha Técnica e Postos de Trabalho Canal Técnico y Puestos de Trabajo Cable Trunking and Workstations Goulottes Techniques et Postes de Travail	45x45



SCAN + INFO



Termoplástico
Termoplastico
Thermoplastic
Thermoplastique



-5°C
+60°C



45x45 Tipo Mosaic
45x45 Type Mosaic
45x45 Type Mosaic
45x45 Type Mosaic



Branco | Vermelho
Blanco | Rojo
White | Red
Blanc | Rouge



745-T-BR ^{ref.}

Tomada Schuko 16 A/250V 2P+T
Toma Schuko 16 A/250V 2P+T
Schuko socket 16 A/250V 2P+T
Socle Schuko 16 A/250V 2P+T

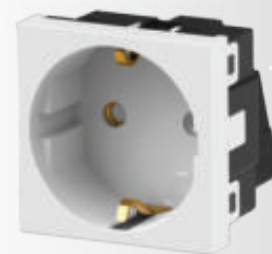

Ref.	Para - For - Pour	Dim. (mm)
745-T-BR	Calha Técnica e Postos de Trabalho Canal Técnico y Puestos de Trabajo Cable Trunking and Workstations Goulottes Techniques et Postes de Travail	45x45

745-T-EN ^{ref.}

Tomada Schuko 16 A/250V 2P+T
Toma Schuko 16 A/250V 2P+T
Schuko socket 16 A/250V 2P+T
Socle Schuko 16 A/250V 2P+T

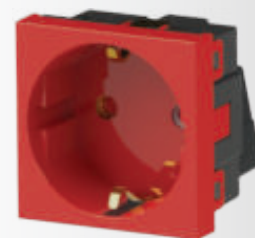

Ref.	Para - For - Pour	Dim. (mm)
745-T-EN	Calha Técnica e Postos de Trabalho Canal Técnico y Puestos de Trabajo Cable Trunking and Workstations Goulottes Techniques et Postes de Travail	45x45

745-F-BR ^{ref.}

Tomada Francesa 16 A/250V 2P+T
Toma Francés 16 A/250V 2P+T
French type socket 16 A/250V 2P+T
Socle 16 A/250V 2P+T



Ref.	Para - For - Pour	Dim. (mm)
745-F-BR	Calha Técnica e Postos de Trabalho Canal Técnico y Puestos de Trabajo Cable Trunking and Workstations Goulottes Techniques et Postes de Travail	45x45

745-F-EN ^{ref.}

Tomada Francesa 16 A/250V 2P+T
Toma Francés 16 A/250V 2P+T
French type socket 16 A/250V 2P+T
Socle 16 A/250V 2P+T

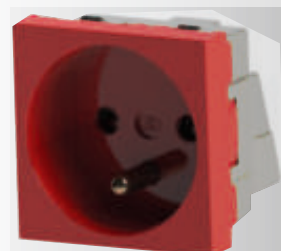

Ref.	Para - For - Pour	Dim. (mm)
745-F-EN	Calha Técnica e Postos de Trabalho Canal Técnico y Puestos de Trabajo Cable Trunking and Workstations Goulottes Techniques et Postes de Travail	45x45



RoHS



REACH



SCAN + INFO



Para circuitos de potência protegidos com UPS ou sistema de energia de apoio.

Para circuitos de alimentação protegidos por UPS o con sistema de apoyo de energia.

For power circuits protected with UPS or power system support.

Pour circuits de puissance protégés avec système d'alimentation sans coupure ou système de soutien d'énergie



Termoplástico
Termoplastico
Thermoplastic
Thermoplastique



-5°C
+60°C



45x45 Tipo Mosaic
45x45 Type Mosaic
45x45 Type Mosaic
45x45 Type Mosaïque



RoHS



HF
HALOGEN FREE



REACH



745-TV ref.

745-TVM ref.

Tomada TV/SAT. 1 modulo e 1/2 módulo | Conector tipo F (Fêmea)
Toma TV/SAT. 1 modulo y 1/2 módulo | Conector tipo F (Hembra)
Socket TV/SAT. 1 modulo and 1/2 module | Type F connector (Female)
Prise TV/SAT. 1 modulo et 1/2 module | Raccord de type F (femelle)

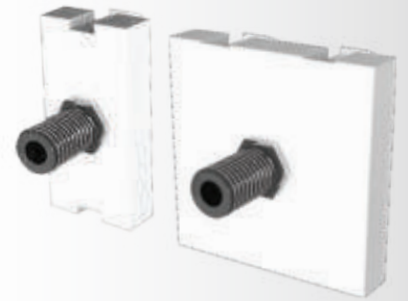

Ref.	Para - For - Pour	Dim. (mm)
745-TV	Calha Técnica e Postos de Trabalho Canal Técnico y Puestos de Trabajo Cable Trunking and Workstations Goulottes Techniques et Postes de Travail	45x45
745-TVM		22,5x45

745-FO ref.

745-FOM ref.

Tomada Fibra Optica TV/SAT. 1 modulo e 1/2 módulo. Com adaptador de fibra SC-APC simplex
Toma Fibra Optica TV/SAT. 1 modulo y 1/2 módulo. Con adaptador de fibra optica SC-APC simplex
Optical fiber Socket TV/SAT. 1 modulo and 1/2 module. With SC-APC simplex fiber coupler
Prise fibre Optique TV/SAT. 1 modulo et 1/2 module. Avec adaptateur de fibre optique SC-APC simplex



Ref.	Para - For - Pour	Dim. (mm)
745-FO	Calha Técnica e Postos de Trabalho Canal Técnico y Puestos de Trabajo Cable Trunking and Workstations Goulottes Techniques et Postes de Travail	45x45
745-FOM		22,5x45

745-C ref.

745-MC ref.

Tecla Cega 45x45 e 1/2 Tecla Cega
Tecla Ciega 45x45 y 1/2 Tecla Ciega
Blank Cover 45x45 and 1/2 Blank Cover
Couvert. Aveugle 45x45 et 1/2 Couvert. Aveugle



Ref.	Para - For - Pour	Dim. (mm)
745-C	Calha Técnica e Postos de Trabalho Canal Técnico y Puestos de Trabajo Cable Trunking and Workstations Goulottes Techniques et Postes de Travail	45x45
745-MC		22,5x45

483-T ref.

Tomada exterior com ligação terra
Toma exterior con conexión de tierra
External socket with ground connection
Prise externe avec connexion à la terre



484 ref.

Tomada exterior
Toma exterior
External Socket
Prise externe



SCAN + INFO

quickvolt

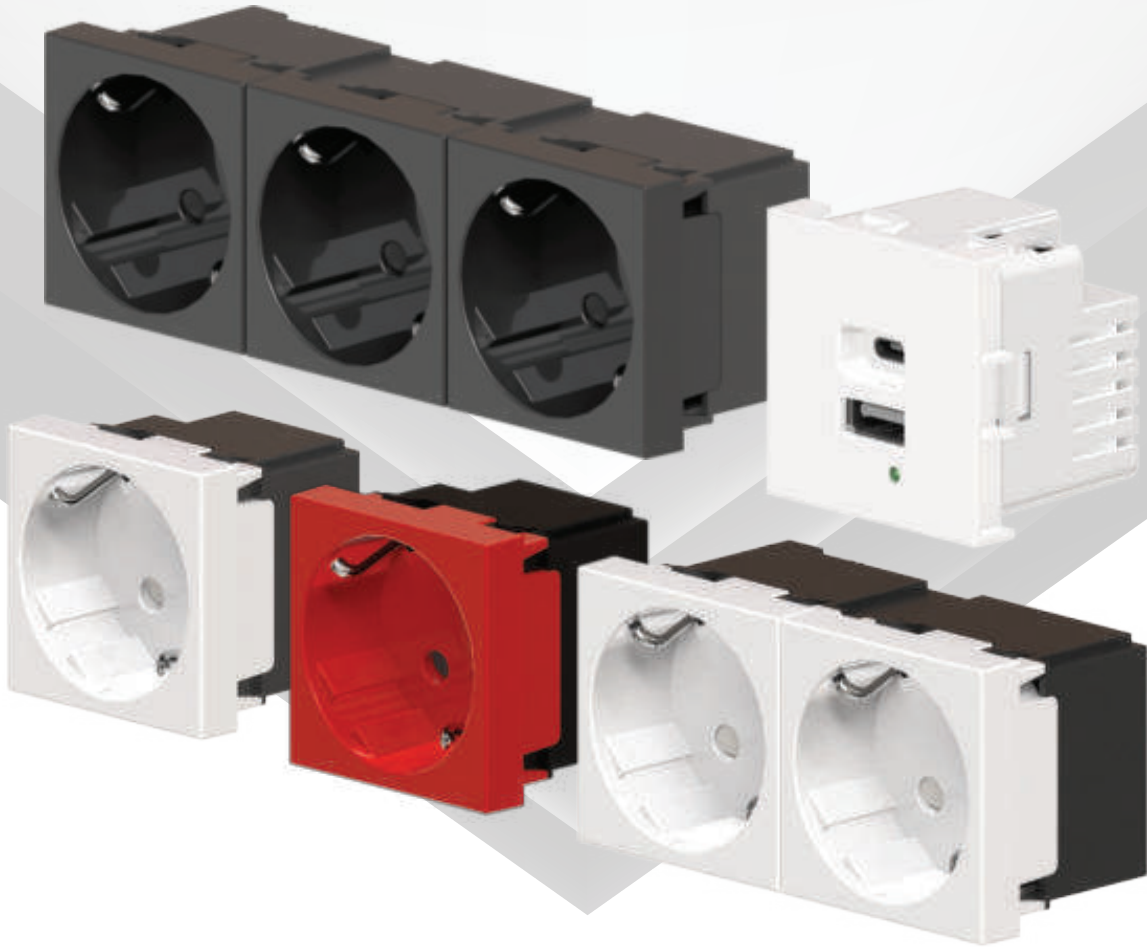

INSTANTLY CONNECTED

Segurança Garantida:

Obturadores de proteção para evitar o contacto acidental. Schuko com saída a 45°.



Ligação Rápida Push-in:

Instalação fácil e sem ferramentas, economizando tempo e esforço. Compatíveis com o formato 45x45.



Integração Perfeita:

Projetadas para integração com os sistemas JSL, incluindo Workstations, Caixas de Chão, IZIBoxline e Calhas Técnicas.



Versatilidade:

Disponíveis nas configurações (simples, duplas, triplas e USB) em 3 cores. Adequadas a qualquer necessidade de instalação e linha estética.



JSL

FICHAS E TOMADAS INDUSTRIAIS

Tomas de corrente industrial
Industrial plugs & sockets
Prises et fiches industrielles





As fichas tomadas industriais tipo CEE podem, e em algumas circunstâncias, devem ser utilizadas na indústria, no comércio, em parques de campismo, na agricultura, em barcos e iates, em camiões caravana.

Os componentes plásticos são fabricados em material termoplástico de alta qualidade o que os torna virtualmente indestrutíveis.

Os bornes são feitos em latão maciço com elevado teor de cobre para evitar sobreaquecimentos.

As fichas tomadas industriais JSL distinguem-se pelas seguintes qualidades que facilitam a instalação e reduzem os custos de manutenção ao mínimo:

- Fáceis de instalar;
- Grande acessibilidade ao espaço de alojamento dos cabos;
- Elevada pressão de contacto;
- Montagem e desmontagem extremamente simples;
- Livres de halógeno;
- Alta resistência a agentes químicos e detergentes;
- Impossibilidade de erros na instalação;
- Parafusos completamente inoxidáveis.



EEC form plugs and sockets can and, under certain circumstances, must be used in industry, in commercial premises, in parks, in agriculture, in marinas, for trailers and mobile homes.

The plastic parts are moulded from a high quality thermoplastic material which is virtually indestructible.

The contact pins and tubes are made of solid brass.

JSL EEC plugs and sockets are distinguished by the following features which ease installation by using outstanding mechanical and electric properties that keep maintenance costs to a minimum:

- Easy to install;
- Very accessible wiring space;
- High contact pressure;
- Low force required for insertion and withdrawal;
- Halogen free;
- High resistance to chemicals and detergents;
- Fool-proof assembly;
- Fully stainless steel screws;
- Screws totally inoxidizable.

Las bases y clavijas industriales tipo CEE se utilizan en sectores industriales muy diversos, desde el comercio, camping, barcos y yates, camiones y caravanas hasta el sector agrícola.

Los componentes plásticos son de un material termoplástico de alta calidad lo que los hace virtualmente indestructibles.

Los bornes son de latón macizo con un alto contenido de cobre para evitar sobrecalentamientos.

Las bases y clavijas industriales JSL se destacan por características que facilitan la instalación y bajan los costes de mantenimiento:

- Fácil instalación;
- Gran accesibilidad al alojamiento de los cables;
- Alta presión de contacto;
- Montaje muy simple;
- Libres de halógenos;
- Alta resistencia a los agentes químicos y disolventes;
- Imposibilidad de errores en la instalación;
- Tornillos completamente inoxidables.



Les prises et fiches industrielles du type CEE peuvent, et doivent, selon les circonstances, être utilisées dans l'industrie, le tertiaire, les campings, l'agriculture, les ports de plaisance, les camions et les mobile homes.

Les composants plastiques ont fabriqués à partir d'un matériel thermoplastique de très haute qualité ce qui les rend quasiment indestructibles.

Les bornes sont fabriquées en laiton massif dans un cuivre e très haute qualité, afin d'éviter tout risque de surchauffe.

Les prises et fiches industrielles JSL se distinguent par les caractéristiques suivantes qui facilitent l'installation et réduisent les coûts de maintenance:

- Installation facile;
- Beaucoup de place pour câbler;
- Bon serrage des contacts aux bornes;
- Montage et démontage très simple;
- Sans halogènes;
- Bonne résistance aux agents chimiques et détergents;
- Montage correct garanti;
- Vis inoxydables



De acordo com as Normas | Conforment aux Normes Conforme las Normas | Norm's compliance



EN 60529 (IP)
EN 50102 (IK)
IEC 60309-1
IEC 60309-2
EN 60309-1
EN 60309-2



BUILT TO OUTLAST

CEE connectors that survive the extreme.
Robust, weather-proof and chemical-resistant,
they provide the casing that protects your energy.
So even in the toughest scenarios, the power stays on.





Fichas - IP44 | Clavijas - IP44
IP44 Plugs | Fiches - IP44

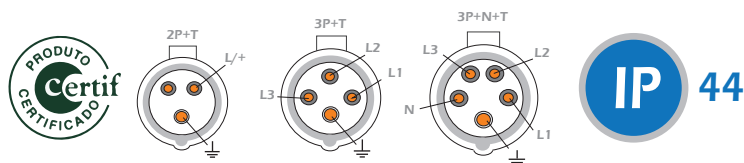

Ref.	Polos	Amp.	Hz	Volt.	IP	IK	mm ²	Ø Cabo (mm ²)
9316/4	2P+T(E)	16	50/60	230	44	09	1,5-4	8 -13
9416/4	3P+T(E)	16	50/60	400	44	09	1,5-4	9 -14
9516/4	3P+N+T(E)	16	50/60	230/400	44	09	1,5-4	10 -16
9332/4	2P+T(E)	32	50/60	230	44	09	2,5-10	12 -18
9432/4	3P+T(E)	32	50/60	400	44	09	2,5-10	13 -20
9532/4	3P+N+T(E)	32	50/60	230/400	44	09	2,5-10	14 -22

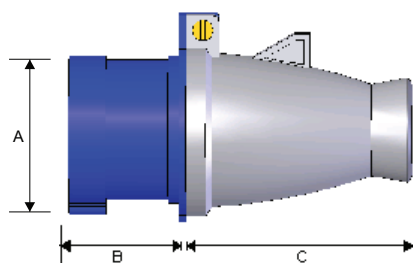

Ref.	A	B	C
9316/4	47	39,5	113,5
9416/4	54	39,5	114,5
9516/4	61	39	133
9332/4	63,5	32	142
9432/4	63,5	49	142
9532/4	63,5	49	162

Tomadas móveis - IP44 | Prolongadores - IP44
IP44 Connectors (couplers) | Prises mobiles - IP44

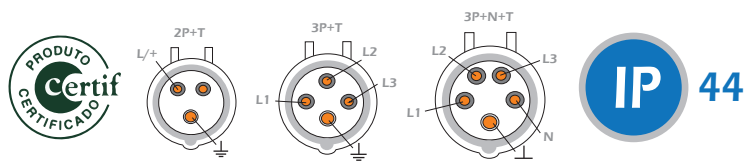

Ref.	Polos	Amp.	Hz	Volt.	IP	IK	mm ²	Ø Cabo (mm ²)
9316/3	2P+T(E)	16	50/60	230	44	09	1,5-4	8 -13
9416/3	3P+T(E)	16	50/60	400	44	09	1,5-4	9 -14
9516/3	3P+N+T(E)	16	50/60	230/400	44	09	1,5-4	10 -16
9332/3	2P+T(E)	32	50/60	230	44	09	2,5-10	12 -18
9432/3	3P+T(E)	32	50/60	400	44	09	2,5-10	13 -20
9532/3	3P+N+T(E)	32	50/60	230/400	44	09	2,5-10	14 -22

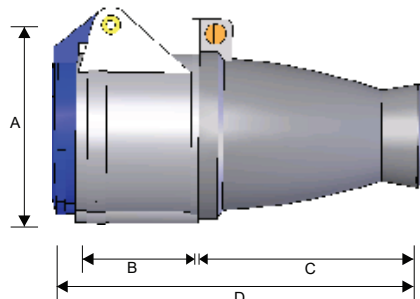

Ref.	A	B	C	D
9316/3	54	42	74	124
9416/3	61	42	74	124
9516/3	68	42	93	143
9332/3	70,5	51,5	94,5	154
9432/3	70,5	51,5	94,5	154
9532/3	76,5	52,5	108,5	170



SCAN + INFO



Termoplástico
Termoplastico
Thermoplastic
Thermoplastique



-5°C
+80°C



Tomadas parede - IP44 | Bases murales - IP44
IP44 Wall receptacles | Socles saillies - IP44

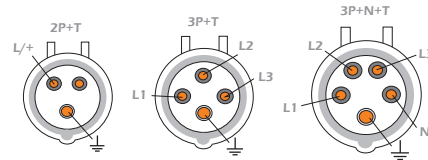

	Ref.	Polos	Amp.	Hz	Volt.	IP	IK	mm ²	Ø Cabo (mm ²)
NOVO - NEW	9316/2N	2P+T(E)	16	50/60	230	44	09	1,5-4	8-13
	9416/2N	3P+T(E)	16	50/60	400	44	09	1,5-4	9-14
	9516/2N	3P+N+T(E)	16	50/60	230/400	44	09	1,5-4	10-16
	9332/2N	2P+T(E)	32	50/60	230	44	09	2,5-10	12-18
	9432/2N	3P+T(E)	32	50/60	400	44	09	2,5-10	13-20
	9532/2N	3P+N+T(E)	32	50/60	230/400	44	09	2,5-10	14-22
	9316/2	2P+T(E)	16	50/60	230	44	09	1,5-4	8-13
	9416/2	3P+T(E)	16	50/60	400	44	09	1,5-4	9-14
	9516/2	3P+N+T(E)	16	50/60	230/400	44	09	1,5-4	10-16
	9332/2	2P+T(E)	32	50/60	230	44	09	2,5-10	12-18
	9432/2	3P+T(E)	32	50/60	400	44	09	2,5-10	13-20
	9532/2	3P+N+T(E)	32	50/60	230/400	44	09	2,5-10	14-22

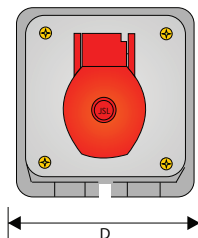
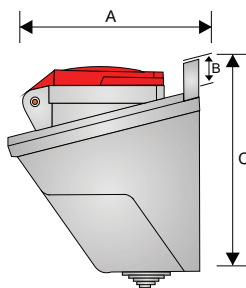
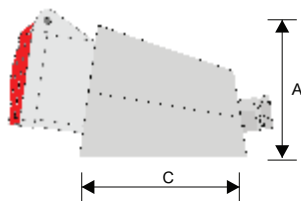

	Ref.	A	B	C	D
NOVO - NEW	9316/2N	87	19	96	84
	9416/2N	104	16	136	86
	9516/2N	104	16	136	86
	9332/2N	104	16	136	86
	9432/2N	104	16	136	86
	9532/2N	104	16	136	86
	9316/2	78		106	52
	9416/2	82		116	56
	9516/2	94		130	68
	9332/2	97		140	68
	9432/2	97		140	65
	9532/2	100		150	74



SCAN + INFO





Tomadas interiores - IP44 | Bases de empotrar - IP44
IP44 Panel mounted receptacles | Socles de tableau - IP44

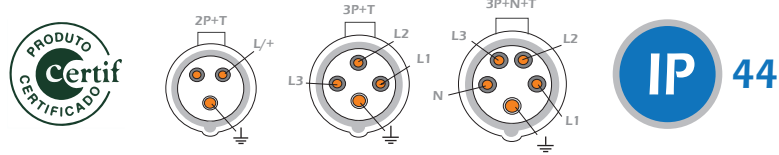

Ref.	Polos	Amp.	Hz	Volt.	IP	IK	mm ²
9316/1	2P+T(E)	16	50/60	230	44	09	1,5-4
9316/1N	2P+T(E)	16	50/60	230	44	09	1,5-4
9416/1	3P+T(E)	16	50/60	400	44	09	1,5-4
9516/1	3P+N+T(E)	16	50/60	230/400	44	09	1,5-4
9332/1	2P+T(E)	32	50/60	230	44	09	2,5-10
9432/1	3P+T(E)	32	50/60	400	44	09	2,5-10
9532/1	3P+N+T(E)	32	50/60	230/400	44	09	2,5-10

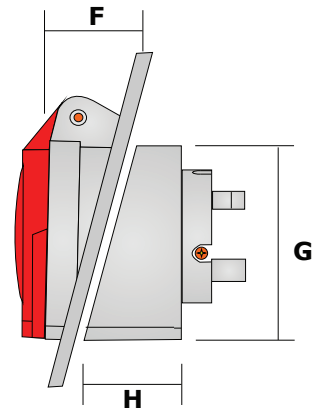
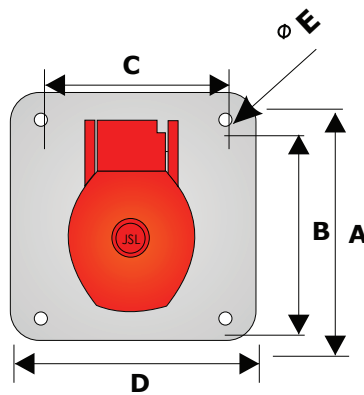

Ref.	A	B	C	D	E	F	G	H
9316/1	80	65	65	80	5,3	18,5	51	19,5
9316/1N	63	47	47	63	4,0	28	53	20
9416/1	85	70	60	75	5,3	28,5	58,5	34
9516/1	85	70	60	75	5,3	32	67,5	32
9332/1	85	70	60	75	5,3	32	69,5	42
9432/1	85	70	60	75	5,3	32	69,5	42
9532/1	85	70	60	75	5,3	32	76	42



SCAN + INFO

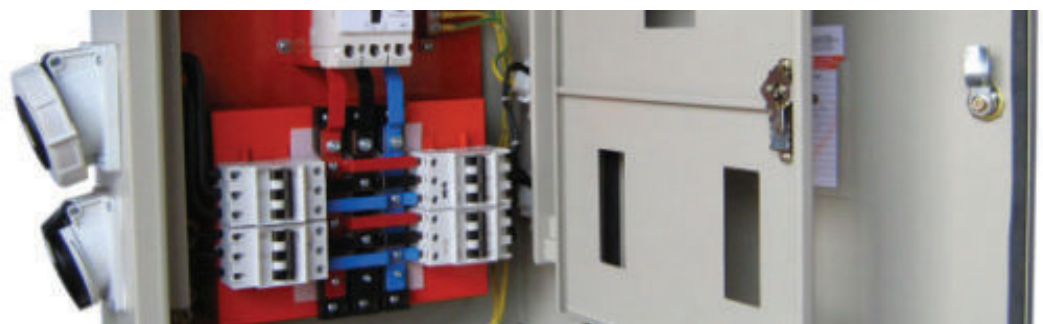



INFO DIAG.

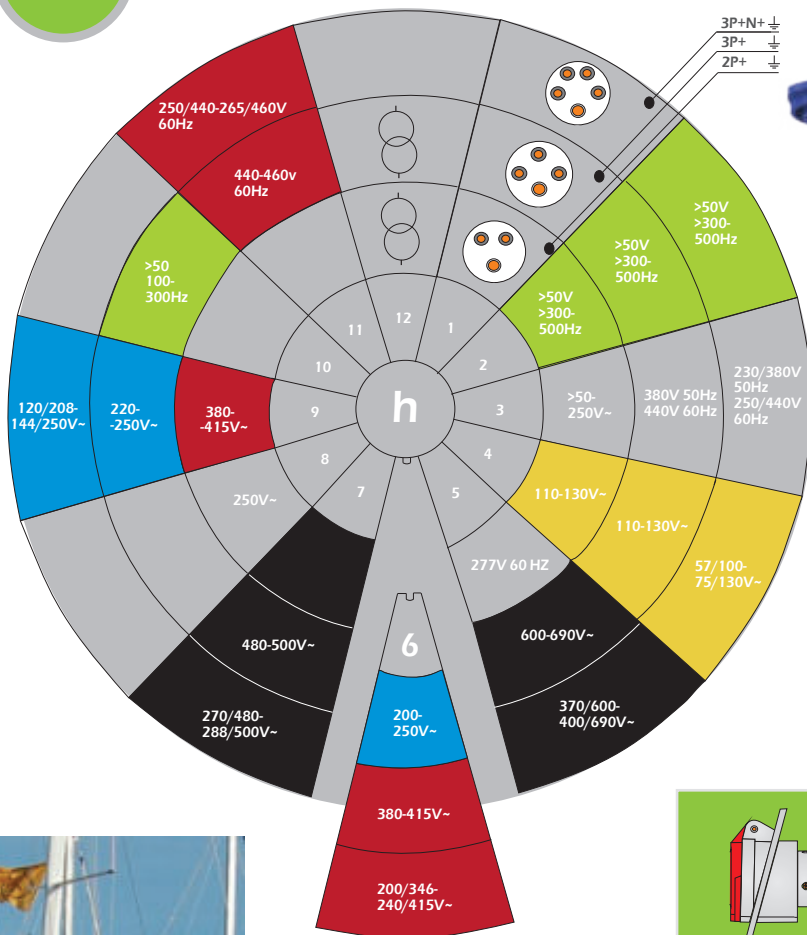

De acordo com as Normas:
 Conforme las Normas:
 Standards compliance:
 Conformant aux Normes:

EN 60309-1
 EN 60309-2
 EN 60529 (para o IP)
 EN 62262 (para o IK)

I = 16-125 A
 U = 50-690 V

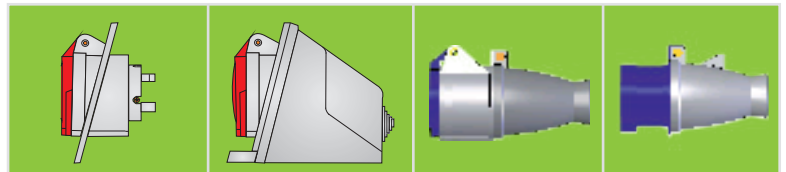

A	Volt.	⚡	IP44 Ref.	IP67 Ref.	IP44 Ref.	IP67 Ref.	IP44 Ref.	IP67 Ref.	IP44 Ref.	IP67 Ref.
16	≈ 230	2P+T(E)	9316/1 9316/1N	679316/1	9316/2N	679316/2	9316/3	679316/3	9316/4	679316/4
	≈ 400	3P+T(E)	9416/1	679416/1	9416/2N	679416/2	9416/3	679416/3	9416/4	679416/4
	≈ 230/400	3P+ N+T(E)	9516/1	679516/1	9516/2N	679516/2	9516/3	679516/3	9516/4	679516/4
32	≈ 230	2P+T(E)	9332/1	679332/1	9332/2N	679332/2	9332/3	679332/3	9332/4	679332/4
	≈ 400	3P+T(E)	9432/1	679432/1	9432/2N	679432/2	9432/3	679432/3	9432/4	679432/4
	≈ 230/400	3P+ N+T(E)	9532/1	679532/1	9532/2N	679532/2	9532/3	679532/3	9532/4	679532/4
63	≈ 250	2P+T(E)	-	679363/5	-	679363/6	-	679363/7	-	679363/8
	≈ 415	3P+T(E)	-	679463/5	-	679463/6	-	679463/7	-	679463/8
	≈ 240/415	3P+ N+T(E)	-	679563/5	-	679563/6	-	679563/7	-	679563/8

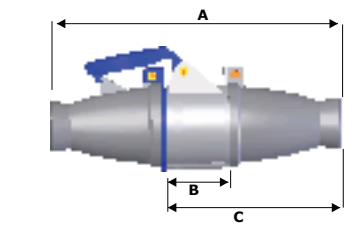

Ref.	A	B	C
9316/3 - 9316/4	194	42	116
9416/3 - 9416/4	194,5	41,5	117
9516/3 - 9516/4	232	42	135
9332/3 - 9332/4	244	51,5	146
9432/3 - 9432/4	244	51,5	146
9532/3 - 9532/4	272	52,5	161

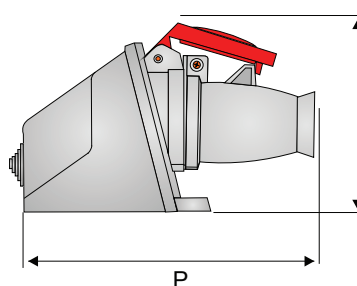

Ref.	P	Q
9316/4 - 9316/2N	162	99
9416/4 - 9416/2N	181	104
9516/4 - 9516/2N	203	104
9332/4 - 9332/2N	203	104
9432/4 - 9432/2N	203	104
9532/4 - 9532/2N	224	104

Fichas - IP67 | Clavijas - IP67
IP67 Plugs | Fiches - IP67

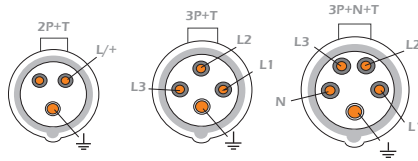
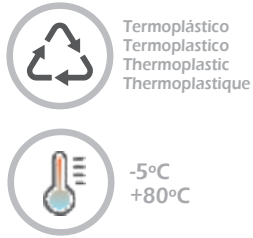

Ref.	Polos	Amp.	Hz	Volt.	IP	IK	mm ²	Ø Cabo (mm ²)
679316/4	2P+T(E)	16	50/60	250	67	09	1,5-2.5	8-12
679416/4	3P+T(E)	16	50/60	415	67	09	1,5-2.5	8-12
679516/4	3P+N+T(E)	16	50/60	240/415	67	09	1,5-2,5	8-12
679332/4	2P+T(E)	32	50/60	250	67	09	2,5-6	12-17
679432/4	3P+T(E)	32	50/60	415	67	09	2,5-6	12-17
679532/4	3P+N+T(E)	32	50/60	240/415	67	09	2,5-6	12-17
679363/8	2P+T(E)	63	50/60	250	67	09	6-16	16-30
679463/8	3P+T(E)	63	50/60	380/415	67	09	6-16	16-30
679563/8	3P+N+T(E)	63	50/60	240/415	67	09	6-16	16-30

Ref.	A	B	C
679316/4	120	71	12
679416/4	125	79	12
679516/4	133	87	12
679332/4	150	93	17
679432/4	150	93	17
679532/4	155	100	17
679363/8	250	112,5	30
679463/8	250	112,5	30
679563/8	250	112,5	30

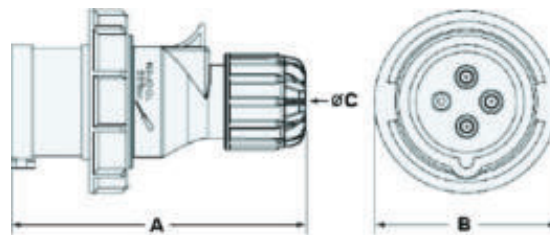

Tomadas móveis - IP67 | Prolongadores - IP67
IP67 Connectors (couplers) | Prises mobiles - IP67

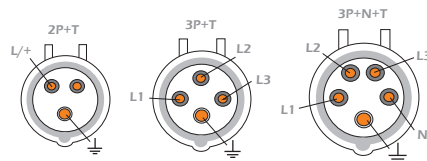

Ref.	Polos	Amp.	Hz	Volt.	IP	IK	mm ²	Ø Cabo (mm ²)
679316/3	2P+T(E)	16	50/60	250	67	09	1,5-2.5	8-12
679416/3	3P+T(E)	16	50/60	415	67	09	1,5-2.5	8-12
679516/3	3P+N+T(E)	16	50/60	240/415	67	09	1,5-2,5	8-12
679332/3	2P+T(E)	32	50/60	250	67	09	2,5-6	12-17
679432/3	3P+T(E)	32	50/60	415	67	09	2,5-6	12-17
679532/3	3P+N+T(E)	32	50/60	240/415	67	09	2,5-6	12-17
679363/7	2P+T(E)	63	50/60	250	67	09	6-16	18-30
679463/7	3P+T(E)	63	50/60	415	67	09	6-16	18-30
679563/7	3P+N+T(E)	63	50/60	240/415	67	09	6-16	18-30

Ref.	A	B	C	D
679316/3	134	80	12	71
679416/3	138	85	12	79
679516/3	146	93	12	87
679332/3	166	98	17	94
679432/3	171	104	17	94
679532/3	271	115	17	100
679363/7	271	115	30	109
679463/7	271	115	30	109
679563/7	271	115	30	109

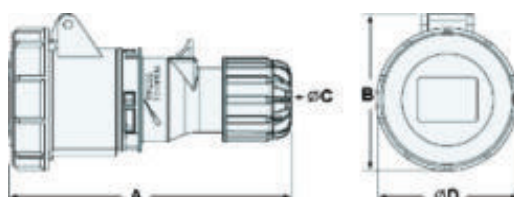

SCAN + INFO

Tomadas parede - IP67 | Bases murales - IP67
IP67 Wall receptacles | Socles saillies - IP67



Termoplástico
Termoplastico
Thermoplastic
Thermoplastique



-5°C
+80°C

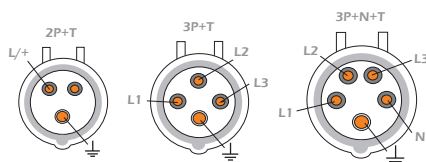

Ref.	Polos	Amp.	Hz	Volt.	IP	IK	mm ²	Ø Cabo (mm ²)
679316/2	2P+T(E)	16	50/60	250	67	09	1,5-4	10-14
679416/2	3P+T(E)	16	50/60	415	67	09	1,5-4	10-14
679516/2	3P+N+T(E)	16	50/60	240/415	67	09	1,5-4	10-14
679332/2	2P+T(E)	32	50/60	250	67	09	2,5-10	12-17
679432/2	3P+T(E)	32	50/60	415	67	09	2,5-10	12-17
679532/2	3P+N+T(E)	32	50/60	240/415	67	09	2,5-10	12-17
679363/6	2P+T(E)	63	50/60	250	67	09	6-25	18-25
679463/6	3P+T(E)	63	50/60	415	67	09	6-25	18-25
679563/6	3P+N+T(E)	63	50/60	240/415	67	09	6-25	18-25

16 A / 32 A

63 A

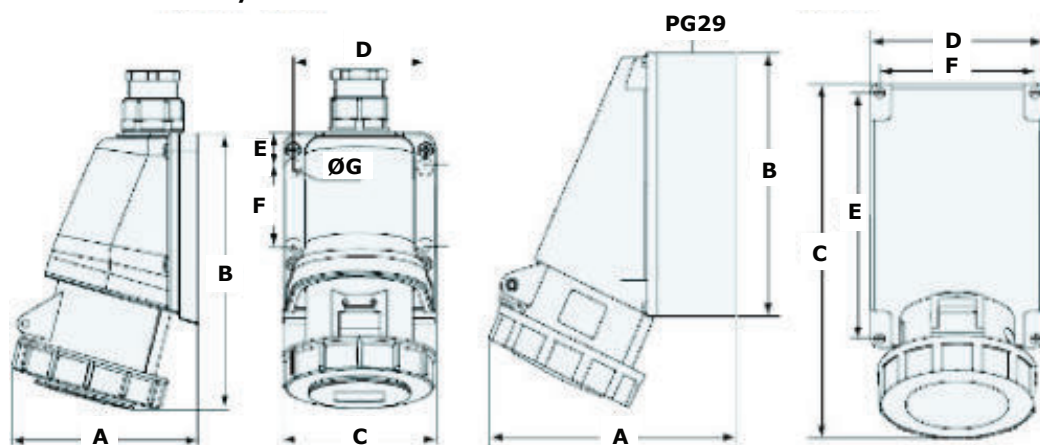

Ref.	A	B	C	D	E	F	G
679316/2	101	150	94	80	20	46	5,5
679416/2	104	150	94	80	20	46	5,5
679516/2	107	151	94	80	20	46	5,5
679332/2	114	162	94	80	20	46	5,5
679432/2	114	162	94	80	20	46	5,5
679532/2	116	163	94	80	20	46	5,5
679363/6	171	170	230	118	158	106	-
679463/6	171	170	230	118	158	106	-
679563/6	171	170	230	118	158	106	-



SCAN + INFO



Termoplástico
Termoplastico
Thermoplastic
Thermoplastique



-5°C
+80°C

Tomadas interiores - IP67 | Bases de empotrar - IP67
IP67 Panel mounted receptacles (angled) | Socles de tableau - IP67

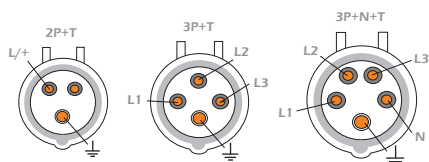

IP 67



Ref.	Polos	Amp.	Hz	Volt.	IP	IK	mm ²
679316/1	2P+T(E)	16	50/60	250	67	09	1,5-4
679416/1	3P+T(E)	16	50/60	415	67	09	1,5-4
679516/1	3P+N+T(E)	16	50/60	240/415	67	09	1,5-4
679332/1	2P+T(E)	32	50/60	250	67	09	2,5-10
679432/1	3P+T(E)	32	50/60	415	67	09	2,5-10
679532/1	3P+N+T(E)	32	50/60	240/415	67	09	2,5-10
679363/5	2P+T(E)	63	50/60	250	67	09	6-25
679463/5	3P+T(E)	63	50/60	415	67	09	6-25
679563/5	3P+N+T(E)	63	50/60	240/415	67	09	6-25

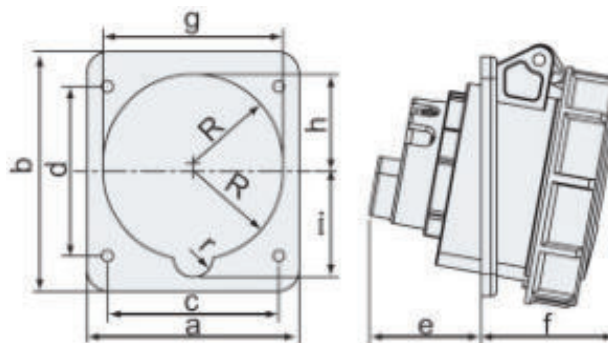

Ref.	a	b	d	d	e	f	g	h	i	R	r
679316/1	76	87	61	61	41	45	64	35	38	32	7
679416/1	76	87	61	61	42	46	64	35	38	32	7
679516/1	76	87	61	61	40	48	64	35	38	32	7
679332/1	76	87	61	61	53	50	64	35	38	32	7
679432/1	76	87	61	61	53	50	64	35	38	32	7
679532/1	80	90	65	70	52	53	70	38	41	35	7
679363/5	100	110	80	85	67	78	81	43	46	41	9
679463/5	100	170	80	85	67	78	81	43	46	41	9
679563/5	100	110	80	85	67	78	81	43	46	41	9



SCAN + INFO

CAIXAS ESTANQUES, BUCINS E LIGADORES

Cajas estancas, prensaestopas y conectores

Cable junction enclosures, cable glands and connectors

Boîtes étanches, presse-étoupes et connecteurs

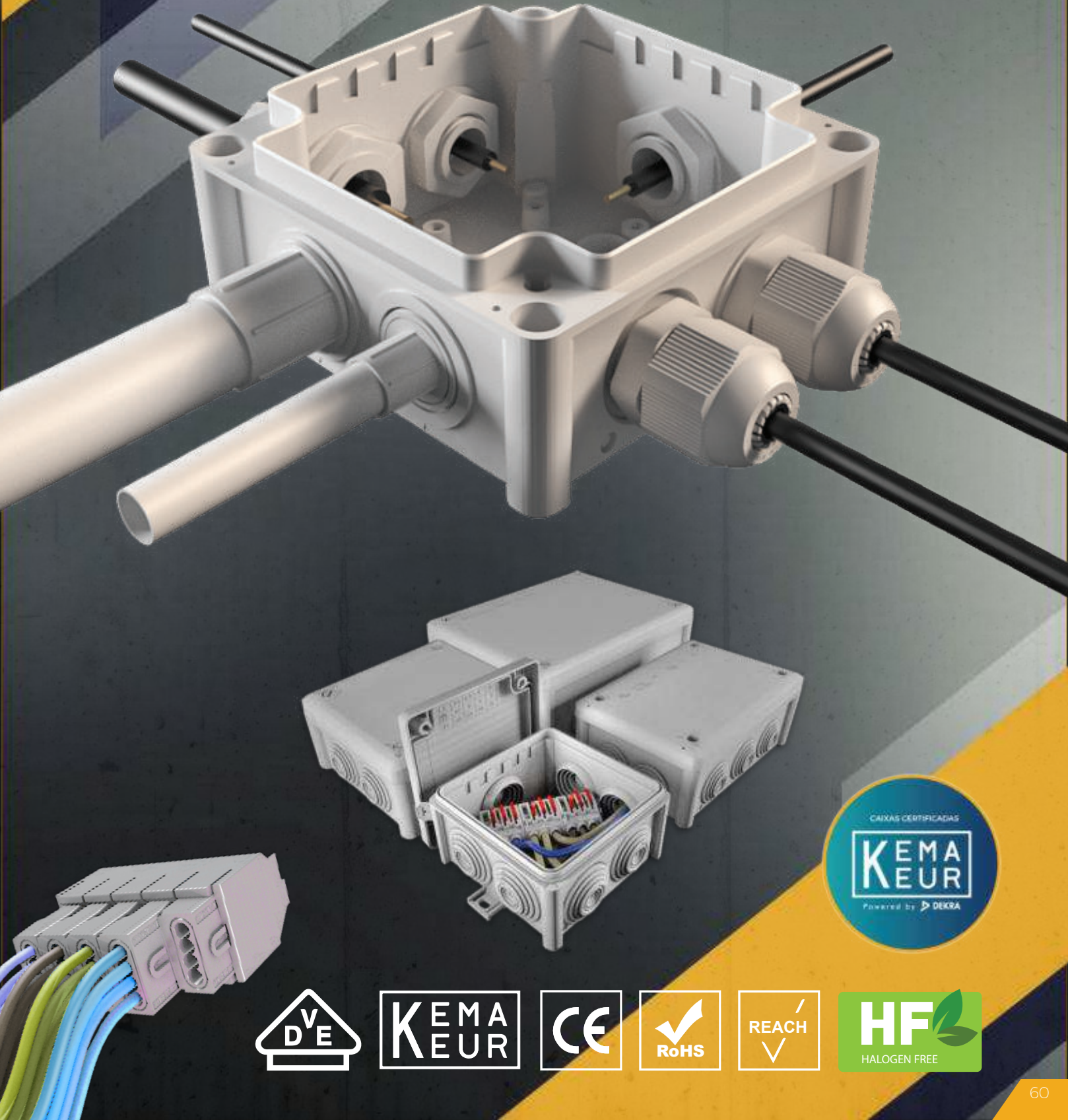

NOVO
NEW

FUSION

SELF-SEALING BOXES

Caixas Auto-Vedantes A Escolha Inteligente

Self-Sealing | The Smart Choice

Caixas Estanques FUSION com membraba e auto-vedantes
Cajas estancas FUSION con membrana y autosellantes
FUSION self-sealing membrane junction boxes
Boîtes étanches FUSION à membranes et auto-étanches



Termoplástico
Termoplastico
Thermoplastic
Thermoplastique



-5°C
+60°C



Autoextinguível
Autoextinguible
Self extinguishing
Autoextinguible



Teste Fio Incandescente
Prueba Hilo Incandescente
Glow Wire Test
Test de Fil Incandescent

Ref. + M0 960°
Ref. + M2 850°



Instalação Rápida
Instalación Rápida
Fast Install
Installation Rapide



Entrada com Membrana IP65
Entrada de Membrana IP65
IP65 Membrane Entry
Entrée à Membrane IP65



Compatível (M16, M20, M25)
Compatible (M16, M20, M25)



Bucim Métrico
Prensaestopa Métrica
Metric Cable Gland
Presse-étoupe Métrique



Instalação com Cabos e Tubos
Instalación con Cables y Tubos
Installation with Cables and conduits
Installation avec de Câbles et Tubes

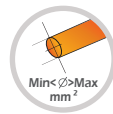

Seção Min-Max (mm²)
Sección Min-Max (mm²)
Min-Max section (mm²)



Nº de entradas
Nº de agujeros
Nº of entries
Nº de connexiones



SCAN + INFO



FAST



IP65

Cabo Único
Single Cable



Vários Cabos
Multiple Cables



Tubo
Conduits



Base e tampa numa só peça.
Nunca perca a tampa.

Base and lid in one piece.
Never lose the lid.



SELF-SEALING BOXES

Resistência à água
e ao pó melhorada

Improved waterproof and dustproof capabilities

Vedante bi-injetado
de fecho estanque

Bi-injected watertight seal



Termoplástico
Termoplastico
Thermoplastic
Thermoplastique



-5°C
+60°C



Autoextinguível
Autoextinguible
Self extinguishing
Autoextinguible



Teste Fio Incandescente
Prueba Hilo Incandescente
Glow Wire Test
Test de Fil Incandescent

960°

850°



Instalação Rápida
Instalación Rápida
Fast Install
Installation Rapide



Entrada com Membrana IP65
Entrada de Membrana IP65
IP65 Membrane Entry
Entrée à Membrane IP65



Compatível (M16, M20, M25)
Compatible (M16, M20, M25)



Bucim Métrico
Prensaestopa Métrica
Metric Cable Gland
Presse-étoupe Métrique



Instalação com Cabos e Tubos
Instalación con Cables y Tubos
Installation with Cables and conduits
Installation avec de Câbles et Tubes



Secção Min-Max (mm²)
Sección Min-Max (mm²)
Min-Max section (mm²)



Nº de entradas
Nº de agujeros
Nº of entries
Nº de connexiones



SCAN + INFO

F65

ref.



Caixa estanque redonda com membranas auto-vedantes
Caja estanca redonda con membranas y autosellante
Round self-sealing membrane junction box
Boîte étanche ronde à membranes et auto-étanche

Redonda, versátil e eficiente, ideal para pontos de luz e instalações compactas.

Round, versatile, and efficient: ideal for lighting points and compact installations.



F80

ref.



Caixa estanque quadrada com membranas auto-vedantes
Caja estanca cuadrada con membranas y autosellante
Square self-sealing membrane junction box
Boîte étanche carrée à membranes et auto-étanche

A solução de eleição para a maioria das instalações de derivação e ligação.

The go-to choice for the majority of junction and wiring installations.



F80-S

ref.



Caixa estanque roscada M20 com membranas auto-vedantes
M20 threaded self-sealing membrane junction box
Caja estanca roscada M20 con membranas y autosellante
Boîte étanche fileté M20 à membranes et auto-étanche

Combina as inovadoras entradas de membrana com entradas roscadas M20 pré-moldadas.

The ultimate in flexibility. It combines innovative membrane entries with pre-molded M20 threaded entries.



F100

ref.



Caixa estanque quadrada com membranas auto-vedantes
Caja estanca cuadrada con membranas y autosellante
Square self-sealing membrane junction box
Boîte étanche carrée à membranes et auto-étanche

Opção de maior dimensão para instalações que requerem mais espaço, ligações complexas ou cabos de maior secção.

Larger size option for installations requiring more space for complex connections or larger cross-section cables.



Ref		Dim. Int (mm)	IP	IK		
F65		65x40	65	08		4+2
F80		80x80x45,5	65	08		8+2
F80-S		81x81x45,5	65	08		8+2
F100		100x100x45,5	65	08		10+2

* Bucim não incluído | Prensaestopas no incluído | Cable glands not included | Presse-étoupes non inclust

OXLINE MARK

NOVO
NEW



Termoplástico
Termoplastico
Thermoplastic
Thermoplastique



-5°C
+60°C



Autoextinguível
Autoextinguible
Self extinguishing
Autoextinguible



Teste Fio incandescente
Prueba Hilo Incandescente
Glow Wire Test
Test de Fil Incandescent

Ref. + M0 960°

Ref. + M2 850°



Compatível
Compatible



Compatível
Compatible



Entradas Marcadas Boxline
Entradas Marcadas Boxline
Boxline Pre-moulded knock-outs
Boxline Presse-étoupes



Abertura fácil
Fácil apertura
Easy opening
Ouverture facile



3/4
Fecho com parafuso a 3/4
Cierre por tornillos a 3/4
Closed by screws at 3/4
Ferme par des vis a 3/4



Secção Min-Max (mm²)
Sección Min-Max (mm²)
Min-Max section (mm²)



Nº de entradas
Nº de agujeros
Nº of entries
Nº de connexiones



SCAN + INFO

Caixas Boxline estanques com entradas marcadas para partir
Cajas Boxline estancas con entradas marcadas para romper
Boxline Cable junction enclosures with pre-moulded knock-outs
Boîtes Boxline de derivation étanches pour découper

IP 66



Instalação com Cabos e Tubos
Instalación con Cables y Tubos
Installation with Cables and conduits
Installation avec de Cables et Tubes

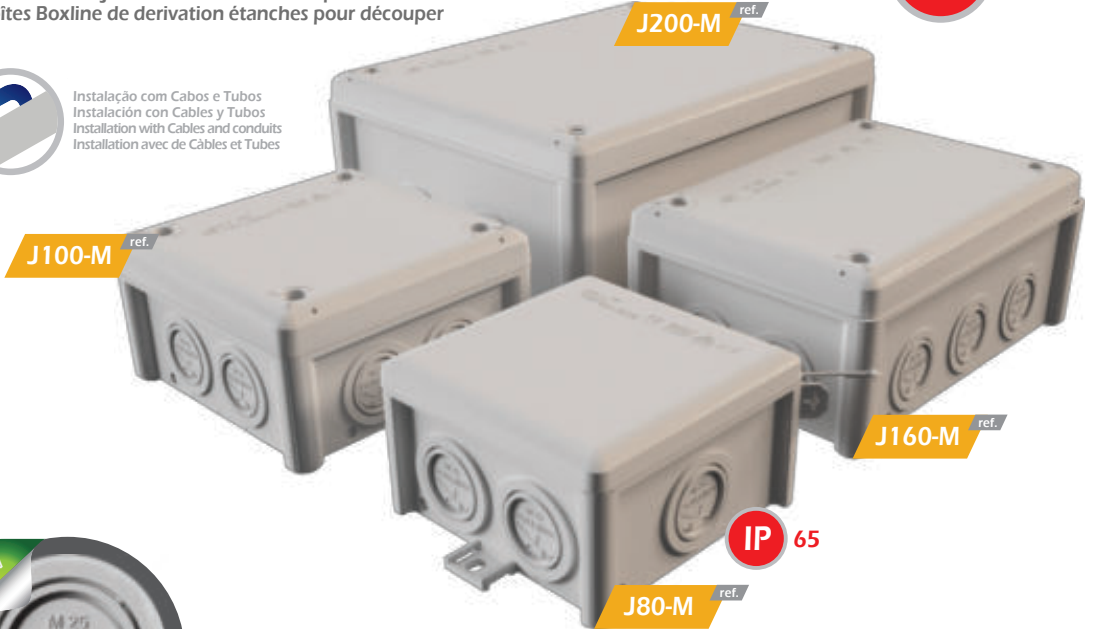

ABERTURA FÁCIL
Novo Desenho com
entradas marcadas
concêntricas

FÁCIL APERTURA
Nuevo diseño con
entradas marcadas
concêntricas

EASY OPENING
New design with
marked concentric
entries

OUVERTURE FACILE
Nouveau design avec
entrées concentriques
marquée

J80-M ref.

J100-M ref. **J160-M** ref.

ENTRADAS PARA
ACCESÓRIOS DIÁMETRO
PG13,5 / M20 / M25

ENTRADAS PARA
ACCESÓRIOS DIÁMETRO
PG13,5 / M20 / M25

INPUTS FOR ACCESSORIES
DIAMETER
PG13,5 / M20 / M25

ENTRÉES POUR
ACCESSOIRES
DIAMÈTRE
PG13,5 / M20 / M25

J200-M ref.

ENTRADAS PARA
ACCESÓRIOS DIÁMETRO
PG13,5 / M20 / M25 / M32

ENTRADAS PARA
ACCESÓRIOS DIÁMETRO
PG13,5 / M20 / M25 / M32

INPUTS FOR
ACCESSORIES DIAMETER
PG13,5 / M20 / M25 / M32

ENTRÉES POUR
ACCESSOIRES DIAMÈTRE
PG13,5 / M20 / M25 / M32

Ref		Dim. Int (mm)	IP	IK			
J80-M	750°	83 x 83 x 50	65	08	7 x PG13,5/M20/M25	1,5-4	8 - 18
J100-M	750°	102x102x55	66	08	7 x PG13,5/M20/M25	1,5-6	8 - 18
J160-M	750°	102 x 152 x 65	66	08	10 x PG13,5/M20/M25	1,5-10	8 - 18
J200-M	750°	152 x 202 x 85	66	08	10 x PG13,5/M20/M25/M32	1,5-16	8 - 18

Todas as referências poderão ser fabricadas em:
Todas las referencias pueden ser fabricadas en:
All references may be manufactured in:
Toutes les références peuvent être fabriquées en:

M2 850°C

M0 960°C

Ex: **J80-M** ref. + **M2** 850°C = **J80-M M2** ref.

EXEMPLO DE INSTALAÇÃO COM MÚLTIPLOS ACESSÓRIOS

EJEMPLO DE INSTALACIÓN CON MÚLTIPLES ACCESORIOS

INSTALLATION EXAMPLE WITH MULTIPLE ACCESSORIES

EXEMPLE D'INSTALLATION AVEC PLUSIEURS ACCESSOIRES

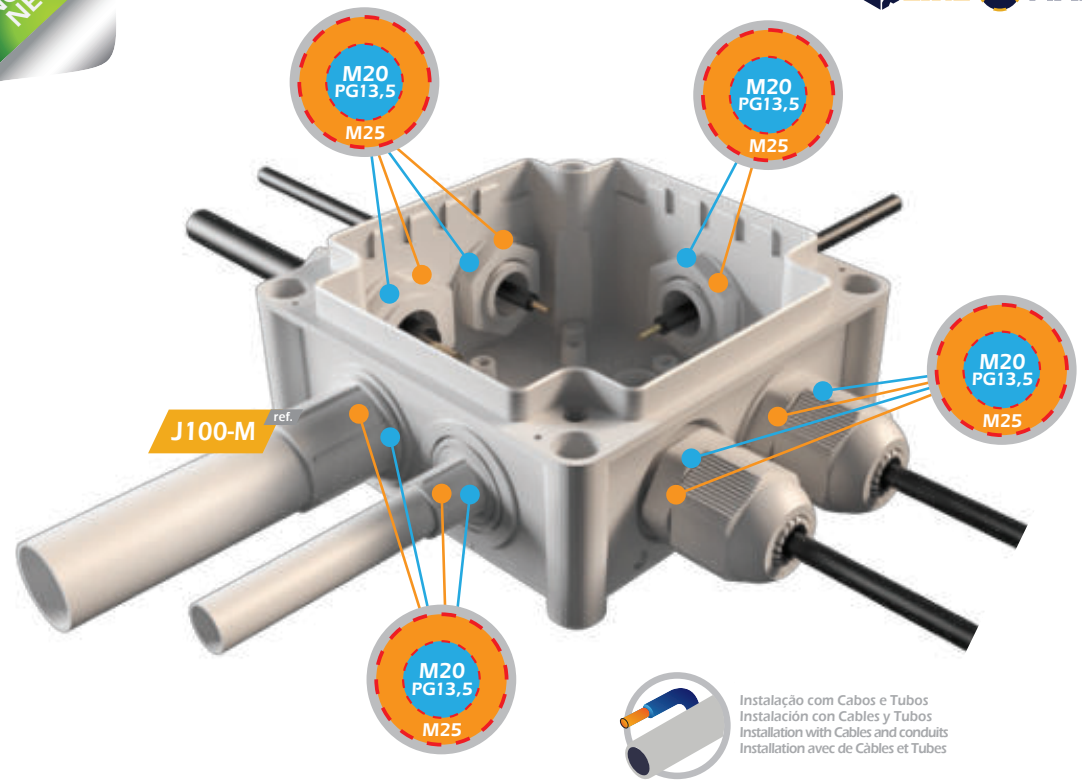

- Termoplástico
Termoplastico
Thermoplastic
Thermoplastique
- 5°C
+60°C
- Autoextinguível
Autoextinguible
Self extinguishing
Autoextinguible
- Teste Fio incandescente
Prueba Hilo Incandescente
Glow Wire Test
Test de Fil Incandescent
- Ref. + M0
960°
- Ref. + M2
850°
- Compatível
Compatible
- Compatível
Compatible
- Entradas Marcadas Boxline
Entradas Marcadas Boxline
Boxline Pre-moulded knock-outs
Boxline Presse-étoupes
- Abertura fácil
Fácil apertura
Easy opening
Ouverture facile
- 3/4
Fecho com parafuso a 3/4
Cierre por tornillos a 3/4
Closed by screws at 3/4
Ferme par des vis a 3/4
- Seção Min-Max (mm²)
Sección Min-Max (mm²)
Min-Max section (mm²)
- Nº de entradas
Nº de agujeros
Nº of entries
Nº de connexiones

ACESSÓRIOS COMPATÍVEIS

ACCESORIOS COMPATIBLES

COMPATIBLE ACCESSORIES

ACCESSOIRES COMPATIBLES



Buçins métricos
Prensaestopas metricas
Metric cable glands
Presse-étoupes métriques



Buçins PG
Prensaestopas PG
PG cable glands
Presse-étoupes PG



Boquilhas roscadas
Racores tubo
Conduit fitting
Raccords de fixation

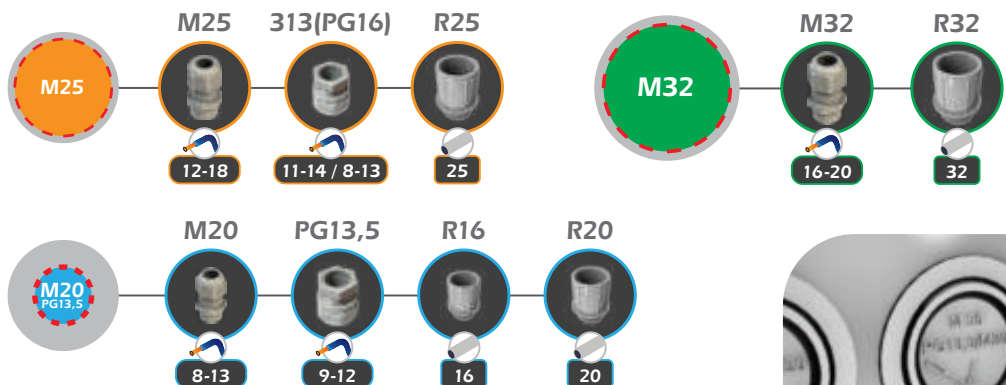
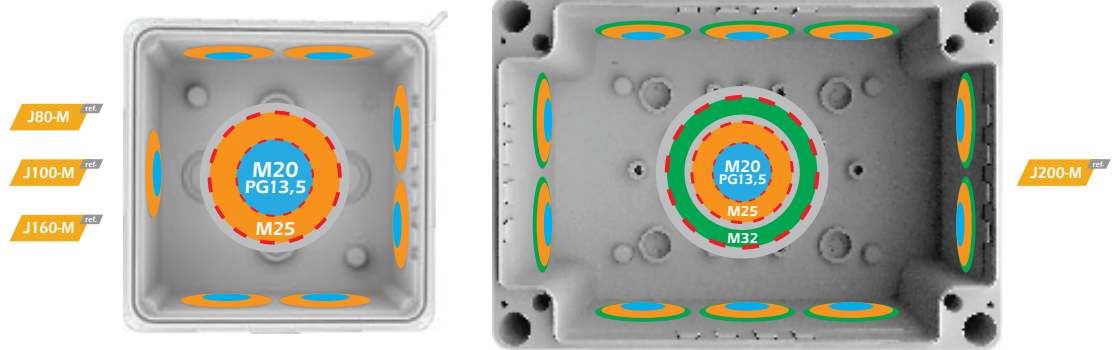

SCAN + INFO

OXLINE MARK

NOVO
NEW



Termoplástico
Termoplastico
Thermoplastic
Thermoplastique



-5°C
+60°C



Autoextinguível
Autoextinguible
Self extinguishing
Autoextinguible



Teste Fio incandescente
Prueba Hilo Incandescente
Glow Wire Test
Test de Fil Incandescent

Ref. + M0 960°

Ref. + M2 850°



Compatível
Compatible



Compatível
Compatible



Entradas Marcadas Boxline
Entradas Marcadas Boxline
Boxline Pre-moulded knock-outs
Boxline Presse-étoupes



Abertura fácil
Fácil apertura
Easy opening
Ouverture facile



Fecho com parafuso a 3/4
Cierre por tornillos a 3/4
Closed by screws at 3/4
Ferme par des vis a 3/4



Secção Min-Max (mm²)
Sección Min-Max (mm²)
Min-Max section (mm²)



Nº de entradas
Nº de agujeros
Nº of entries
Nº de connections



SCAN + INFO

Caixas Boxline estanques com entradas marcadas para partir
Cajas Boxline estancas con entradas marcadas para romper
Boxline Cable junction enclosures with pre-moulded knock-outs
Boîtes Boxline de derivation étanches pour découper

IP 66



Instalação com Cabos e Tubos
Instalación con Cables y Tubos
Installation with Cables and conduits
Installation avec de Cables et Tubes

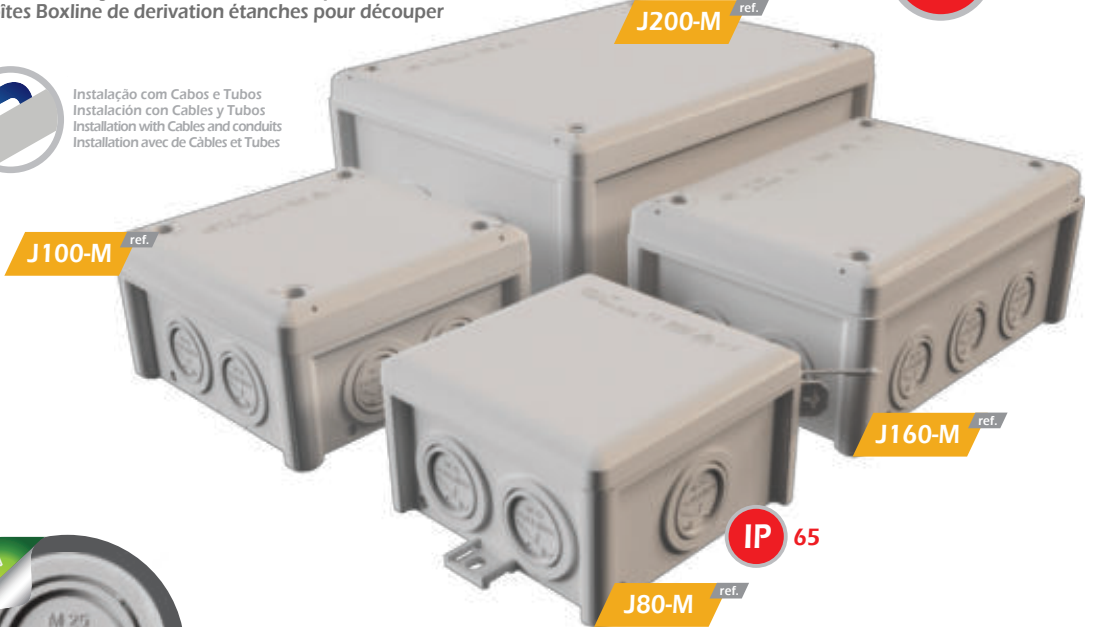

ABERTURA FÁCIL
Novo Desenho com
entradas marcadas
concêntricas

FÁCIL APERTURA
Nuevo diseño con
entradas marcadas
concêntricas

EASY OPENING
New design with
marked concentric
entries

OUVERTURE FACILE
Nouveau design avec
entrées concentriques
marquée

J80-M ref.

J100-M ref. **J160-M** ref.

**ENTRADAS PARA
ACESSÓRIOS DIÂMETRO
PG13,5 / M20 / M25**

**ENTRADAS PARA
ACESSÓRIOS DIÂMETRO
PG13,5 / M20 / M25**

**INPUTS FOR ACCESSORIES
DIAMETER
PG13,5 / M20 / M25**

**ENTRÉES POUR
ACCESSOIRES
DIAMÈTRE
PG13,5 / M20 / M25**

J200-M ref.

**ENTRADAS PARA
ACESSÓRIOS DIÂMETRO
PG13,5 / M20 / M25 / M32**

**ENTRADAS PARA
ACESSÓRIOS DIÂMETRO
PG13,5 / M20 / M25 / M32**

**INPUTS FOR
ACCESSORIES DIAMETER
PG13,5 / M20 / M25 / M32**

**ENTRÉES POUR
ACCESSOIRES DIAMÈTRE
PG13,5 / M20 / M25 / M32**

Ref		Dim. Int (mm)	IP	IK			
J80-M	750°	83 x 83 x 50	65	08	7 x PG13,5/M20/M25	1,5-4	8 - 18
J100-M	750°	102x102x55	66	08	7 x PG13,5/M20/M25	1,5-6	8 - 18
J160-M	750°	102 x 152 x 65	66	08	10 x PG13,5/M20/M25	1,5-10	8 - 18
J200-M	750°	152 x 202 x 85	66	08	10 x PG13,5/M20/M25/M32	1,5-16	8 - 18

Todas as referências poderão ser fabricadas em:
Todas las referencias pueden ser fabricadas en:
All references may be manufactured in:
Toutes les références peuvent être fabriquées en:

M2 850°C

M0 960°C

Ex: **J80-M** ref. + **M2** 850°C = **J80-M M2** ref.

EXEMPLO DE INSTALAÇÃO COM MÚLTIPLOS ACESSÓRIOS | EJEMPLO DE INSTALACIÓN CON MÚLTIPLES ACCESORIOS | INSTALLATION EXAMPLE WITH MULTIPLE ACCESSORIES | EXEMPLE D'INSTALLATION AVEC PLUSIEURS ACCESSOIRES

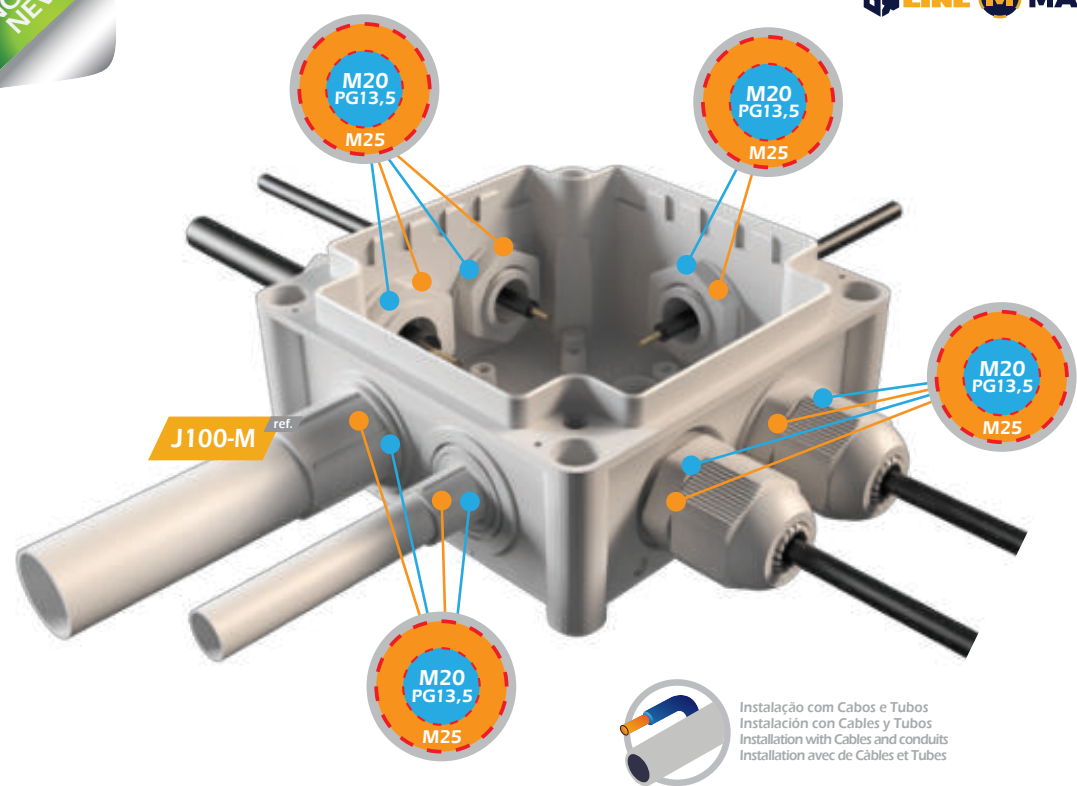

Instalação com Cabos e Tubos
 Instalación con Cables y Tubos
 Installation with Cables and conduits
 Installation avec de Câbles et Tubes

- Termoplástico
Termoplastico
Thermoplastic
Thermoplastique
- 5°C
+60°C
- Autoextinguível
Autoextinguible
Self extinguishing
Autoextinguible
- Teste Fio incandescente
Prueba Hilo Incandescente
Glow Wire Test
Test de Fil Incandescent
- Ref. + M0
960°
- Ref. + M2
850°
- Compatível
Compatible
- Compatível
Compatible
- Entradas Marcadas Boxline
Entradas Marcadas Boxline
Boxline Pre-moulded knock-outs
Boxline Presse-étoupes
- Abertura fácil
Fácil apertura
Easy opening
Ouverture facile
- 3/4
Fecho com parafuso a 3/4
Cierre por tornillos a 3/4
Closed by screws at 3/4
Ferme par des vis a 3/4
- Seção Min-Max (mm²)
Sección Min-Max (mm²)
Min-Max section (mm²)
- Nº de entradas
Nº de agujeros
Nº of entries
Nº de connexiones

ACESSÓRIOS COMPATÍVEIS	ACCESORIOS COMPATIBLES	COMPATIBLE ACCESSORIES	ACCESSOIRES COMPATIBLES
Bucins métricos Prensaestopas metricas Metric cable glands Presse-étoupes métriques	Bucins PG Prensaestopas PG PG cable glands Presse-étoupes PG		Boquilhas roscadas Racores tubo Conduit fitting Raccords de fixation

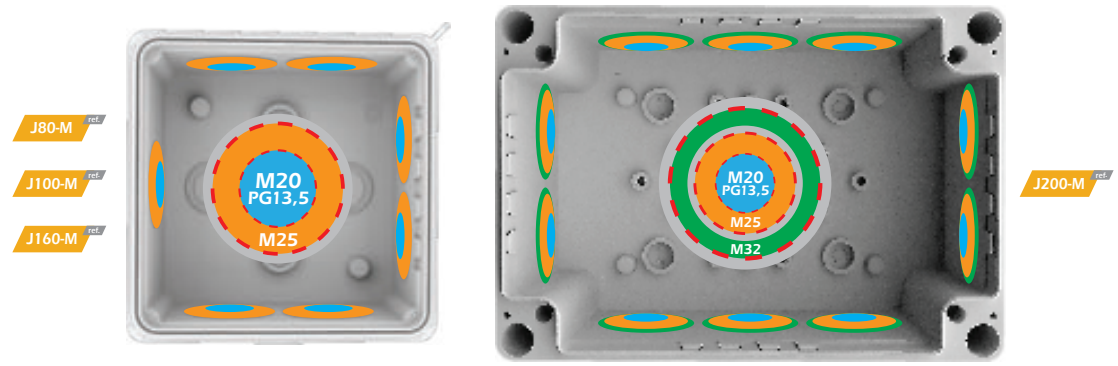

	M25	313(PG16)	R25		M32	R32
	12-18	11-14 / 8-13	25		16-20	32
	M20	PG13,5	R16			
	8-13	9-12	16			
			R20			
			20			



SCAN + INFO





LINEKOMBO

- Termoplástico
Termoplastico
Thermoplastic
Thermoplastique
- 5°C
+60°C
- Autoextinguível
Autoextinguible
Self extinguishing
Autoextinguible
- Teste Fio Incandescente
Prueba Hilo Incandescente
Glow Wire Test
Test de Fil Incandescent
- Ref. + M0 960°
Ref. + M2 850°
- Entradas Mistas
Entradas Mistas
Entradas Mistas
Entradas Mistas
- PG13,5
PG16
Compatível
Compatible
- M20
M25
M32
Compatível
Compatible
- Abertura fácil
Fácil apertura
Easy opening
Ouverture facile
- 3/4
Fecho com parafuso a 3/4
Cierre por tornillos a 3/4
Closed by screws at 3/4
Ferme par des vis a 3/4
- Secção Min-Max (mm²)
Sección Min-Max (mm²)
Min-Max section (mm²)
- Nº de entradas
Nº de agujeros
Nº of entries
Nº de connexiones



Caixas Boxline estanques com entradas mistas
Cajas Boxline estancas con entradas mixtas
Boxline Cable junction enclosures with mixed entries
Boîtes Boxline de dérivation étanches avec entrées mixtes

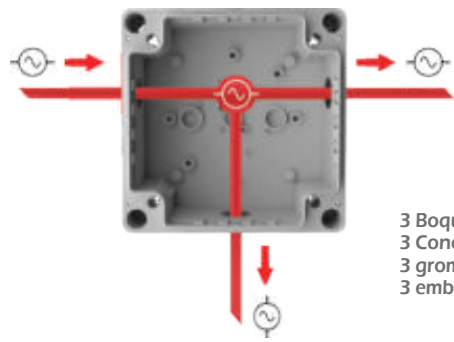

Instalação com Cabos e Tubos
Instalación con Cables y Tubos
Installation with Cables and conduits
Installation avec de Câbles et Tubes

3 Boquilhas + 4 entradas marcadas para partir
3 Conos + 4 entradas marcadas para romper
3 gromets + 4 knock-outs entries
3 embouts à tétine + pour découper



ABERTURA FÁCIL Novo Desenho com entradas marcadas concêntricas
FÁCIL APERTURA Nuevo diseño con entradas marcadas concêntricas
EASY OPENING New design with marked concentric entries
OUVERTURE FACILE Nouveau design avec entrées concentriques marquée

4 ENTRADAS PARA
ACESSÓRIOS DIÂMETRO
PG13,5 / M20 / M25

4 ENTRADAS PARA
ACCESORIOS DIÂMETRO
PG13,5 / M20 / M25

4 INPUTS FOR
ACCESSORIES DIAMETER
PG13,5 / M20 / M25

4 ENTRÉES POUR
ACCESSOIRES
DIAMÈTRE
PG13,5 / M20 / M25

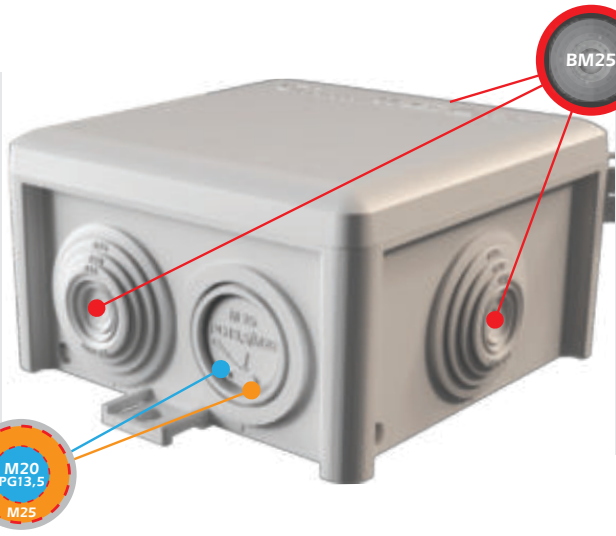

3 ENTRADAS
COM BOQUILHAS
MÉTRICAS BM25

3 ENTRADAS
CON CONOS
MÉTRICOS BM25

3 ENTRIES WITH BM25
STEPPED RUBBER
METRIC GROMMETS

3 ENTREES BM25 AVEC
EMBOUTS À
GRADIN DU MÉTRIQUES



Ref		Dim. Int (mm)	IP	IK			
J80-MK	750°	83 x 83 x 50	65	08	4 x PG13,5/M20/M25 + 3 x BM25	1,5-4	Variável - Variable
J100-MK	750°	102x102x55	66	08	4 x PG13,5/M20/M25 + 3 x BM25	1,5-6	Variável - Variable

Todas as referências poderão ser fabricadas em:
Todas las referencias pueden ser fabricadas en:
All references may be manufactured in:
Toutes les références peuvent être fabriquées en:

M2 850°C M0 960°C

Ex: J80-MK ^{ref.} + M2 850°C = J80-MK M2 ^{ref.}



SCAN + INFO

EXEMPLO DE INSTALAÇÃO COM MÚLTIPLOS ACESSÓRIOS

EJEMPLO DE INSTALACIÓN CON MÚLTIPLES ACCESORIOS

INSTALLATION EXAMPLE WITH MULTIPLE ACCESSORIES

EXEMPLE D'INSTALLATION AVEC PLUSIEURS ACCESSOIRES

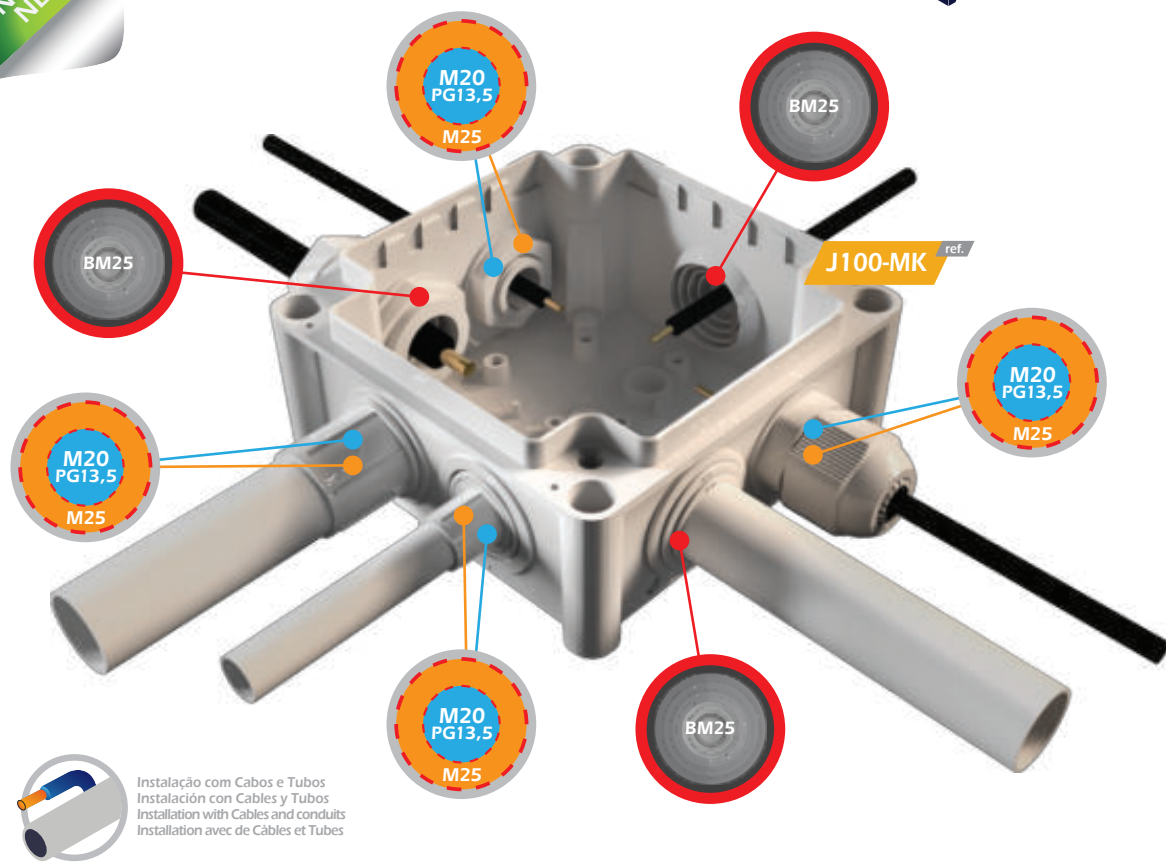

- Termoplástico
Termoplastico
Thermoplastic
Thermoplastique
- 5°C
+60°C
- Autoextinguível
Autoextinguible
Self extinguishing
Autoextinguible
- Teste Fio incandescente
Prueba Hilo Incandescente
Glow Wire Test
Test of Fil Incandescent
- Ref. + M0 960°
Ref. + M2 850°
- Entradas Mistas
Entradas Mistas
Entradas Mistas
Entradas Mistas
- PG13,5
PG16 Compatível
Compatible
- M20
M25 (M32-J200) Compatível
Compatible
- Abertura fácil
Fácil abertura
Easy opening
Ouverture facile
- 3/4 Fecho com parafuso a 3/4
Cierre por tornillos a 3/4
Closed by screws at 3/4
Ferme par des vis a 3/4
- Seção Min-Max (mm²)
Sección Min-Max (mm²)
Min-Max section (mm²)
- Nº de entradas
Nº de agujeros
Nº of entries
Nº de connexiones

Instalação com Cabos e Tubos
Instalación con Cables y Tubos
Installation with Cables and conduits
Installation avec de Câbles et Tubes

ACESSÓRIOS COMPATÍVEIS

ACCESORIOS COMPATIBLES

COMPATIBLE ACCESSORIES

ACCESSOIRES COMPATIBLES



Buçins métricos
Prensaestopas metricas
Metric cable glands
Presse-étoupes métriques



Buçins PG
Prensaestopas PG
PG cable glands
Presse-étoupes PG



Boquilhas roscadas
Racores tubo
Conduit fitting
Raccords de fixation

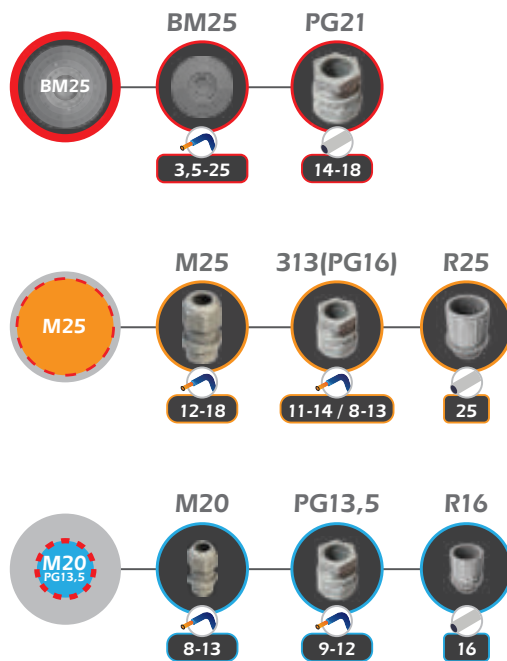

SCAN + INFO



Termoplástico
Termoplastico
Thermoplastic
Thermoplastique



-5°C
+60°C



Autoextinguível
Autoextinguible
Self extinguishing
Autoextinguible



Teste Fio Incandescente
Prueba Hilo Incandescente
Glow Wire Test
Test of Fil Incandescent

Ref. + M0

960°

Ref. + M2

850°



Entradas recortadas
Notched entries
Entrées crantées



3/4
Fecho com parafuso a 3/4
Cierre por tornillos a 3/4
Closed by screws at 3/4
Ferme par des vis a 3/4

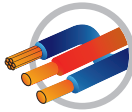

Para usar com Cabos
Para uso con Cables
To use with Cables
Utiliser avec de Câbles



Seção Min-Max (mm²)
Sección Min-Max (mm²)
Min-Max section (mm²)



Nº de entradas
Nº de agujeros
Nº of entries
Nº de connexions

NOVO
NEW



LINE

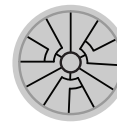

PUSH

IP 30

Caixas Boxline com entradas recortadas
Cajas Boxline con entradas recortadas
Boxline Boxes with notched entries
Boîtes Boxline avec entrées crantées (au entailées)



- Para uso exclusivo em ambiente interior em locais sem necessidade de requisitos especiais de estanqueidade;
- "Puxadas" de caixas assentes em bandeja de cabos, tectos e paredes falsas;
- Instalações temporárias em tectos e paredes em áreas fora do alcance das pessoas
- Para uso exclusivo en un ambiente interior en lugares sin la necesidad de requisitos especiales de estanqueidad;
- "Tramos" de cajas soportadas en bandejas de cables, techos y paredes falsas;
- Instalaciones temporales en techos y paredes en zonas fuera del alcance de las personas.
- For exclusive use in an indoor environment in places without the need for special tightness requirements;
- "Branches" of boxes fixed on cable trays, false ceilings and walls;
- Temporary installations on ceilings and walls in areas out of people access.
- Pour une utilisation exclusive dans un environnement intérieur dans des endroits sans avoir besoin d'exigences spéciales d'étanchéité;
- "Branches" de boîtes fixées sur des chemins de câbles, de faux plafonds et des murs;
- Installations temporaires au plafond et aux murs dans des zones hors de portée de personnes



Dispensa o uso de buçins, boquilhas para retenção de cabo
No necesita prensas, racores ni conos para retención de cable
No need for glands, pipe-sheath fitting or grommets for cable retention
Pas besoin de presse-étoupes, ou embouts à gradin pour la rétention des câbles



6,5-20

INSTALAÇÃO RÁPIDA
Permite a ancoragem dos
cabos embainhados

INSTALACIÓN RÁPIDA
Permite el anclaje de
cables enfundados

QUICK INSTALLATION
It allows the anchoring of
sheathed cables

INSTALLATION RAPIDE
Il permet l'ancrage de
câbles gainés

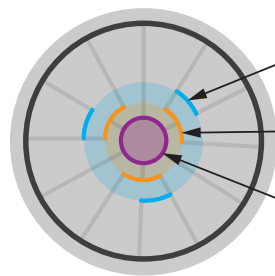

Ø 15mm → 15,5-20

Ø 10,2mm → 10,5-15

Ø 6,5mm → 6,5-10



Ref		Dim. Int (mm)	IP	IK		Min-Max mm ²	Ø
J80-P	750°	83 x 83 x 50	30	08	7	1,5-4	6,5-20
J100-P	750°	102x102x55	30	08	7	1,5-6	6,5-20
J160-P	750°	102 x 152 x 65	30	08	10	1,5-10	6,5-20
J200-P	750°	152 x 202 x 85	30	08	10	1,5-16	6,5-20

Todas as referências poderão ser fabricadas em:
Todas las referencias pueden ser fabricadas en:
All references may be manufactured in:
Toutes les références peuvent être fabriquées en:

M2 850°C

M0 960°C

Ex: J80-P ref. + M2 850°C = J80-P M2 ref.



SCAN + INFO



Termoplástico
Termoplastico
Thermoplastic
Thermoplastique



-5°C
+60°C



Autoextinguível
Autoextinguible
Self extinguishing
Autoextinguible



Teste Fio incandescente
Prueba Hilo Incandescente
Glow Wire Test
Test de Fil Incandescent

Ref. + M0



960°

Ref. + M2



850°



Aplicação por pressão
Aplicación presión
Pressure application
Application à pression



Fecho com parafuso a 3/4
Cierre por tornillos a 3/4
Closed by screws at 3/4
Ferme par des vis a 3/4



Instalação com Cabos e Tubos
Instalación con Cables y Tubos
Installation with Cables and conduits
Installation avec de Câbles et Tubes



Secção Min-Max (mm²)
Sección Min-Max (mm²)
Min-Max section (mm²)



Nº de entradas
Nº de agujeros
Nº of entries
Nº de connexiones



SCAN + INFO



Boquilhas IP 66
Conos IP 66
Grommets IP 66
Gradin IP66



Caixas estanques com boquilhas
Cajas estancas con conos
Cable Junction enclosures with stepped rubber grommets
Boîtes de dérivation étanches avec embouts à gradin



Ref		Dim. Int (mm)	IP	IK		Min\varnothingMax mm ²	Ø
J80-B	750°	83 x 83 x 50	65	08	7 x M25	1,5-4	3,5-25
J100-B	750°	102x102x55	66	08	7 x M25	1,5-6	3,5-25
J160-B	750°	102 x 152 x 65	66	08	10 x M25	1,5-10	3,5-25
J200-B	750°	152 x 202 x 85	66	08	10 x M32	1,5-16	3,5-32

* Boquilhas incluídas | Conos incluidos | Stepped Rubber Grommet included | Embouts à gradin inclut



Caixas estanques com paredes lisas
Cajas estancas con paredes lisas
Cable junction enclosures with plain walls
Boîtes de dérivation étanches non percées



Ref		Dim. Int (mm)	IP	IK	Min\varnothingMax mm ²
J80-L	750°	83 x 83 x 50	65	08	1,5-4
J100-L	750°	102x102x55	66	08	1,5-6
J160-L	750°	102 x 152 x 65	66	08	1,5-10
J200-L	750°	152 x 202 x 85	66	08	1,5-16

Todas as referências poderão ser fabricadas em:
Todas las referencias pueden ser fabricadas en:
All references may be manufactured in:
Toutes les références peuvent être fabriquées en:

M2 850°C

M0 960°C

Ex: 220-B ^{ref.} + M2 850°C = 220-B M2 ^{ref.}



Termoplástico
Termoplastico
Thermoplastic
Thermoplastique



-5°C
+60°C



Autoextinguível
Autoextinguible
Self extinguishing
Autoextinguible



Teste Fio Incandescente
Prueba Hilo Incandescente
Glow Wire Test
Test de Fil Incandescent

Ref. + M0 960°

Ref. + M2 850°



Aplicação por pressão
Aplicación presión
Pressure application
Application à pression



3/4
Fecho com parafuso a 3/4
Cierre por tornillos a 3/4
Closed by screws at 3/4
Ferme par des vis a 3/4



Instalação com Cabos e Tubos
Instalación con Cables y Tubos
Installation with Cables and conduits
Installation avec de Câbles et Tubes



Seção Min-Max (mm²)
Sección Min-Max (mm²)
Min-Max section (mm²)



Nº de entradas
Nº de agujeros
Nº of entries
Nº de connexiones



Boquilhas IP 66
Conos IP 66
Grommets IP 66
Gradin IP66



Caixas estanques com tampa alta
Cajas estancas con tapa alta
Cable Junction enclosures with high cover
Boîtes de dérivation étanches avec couvercle haute



3900ml

J200 BTA TR ref.

J200 LTA TR ref.

J200 BTA ref.

J200 LTA ref.

Ref		Dim. Int (mm)	IP	IK			
J200-BTA	750°	152 x 202 x 125	66	08	10 x M32	1,5-16	3,5-32
J200-BTATR	750°	152 x 202 x 125	66	08	10 x M32	1,5-16	3,5-32
J200-LTA	750°	152 x 202 x 125	66	08	-	1,5-16	-
J200-LTATR	750°	152 x 202 x 125	66	05	-	1,5-16	-

* Boquilhas incluídas | Conos incluídos | Stepped Rubber Grommet included | Embouts à gradin incluíd



J100-S ref.



Caixas estanques com entradas roscadas 7 x M20
Cajas estancas con entradas roscadas 7 x M20
Cable junction enclosures with screwed entries 7 x M20
Boîtes de dérivation avec entrées filetées 7 x M20

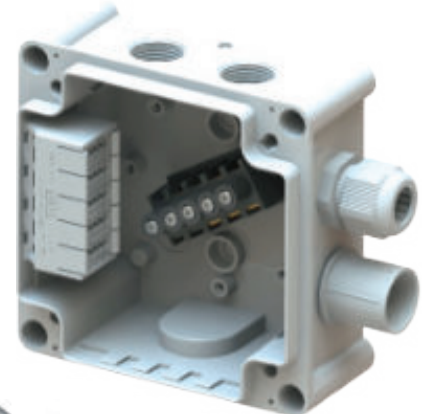

Ref		Dim. Int (mm)	IP	IK			
J100-S	750°	102 x 102 x 55	66	08	7 x M20	8 - 13	1,5-6

* Bucim não incluído | Prensaestopas no incluído | Cable glands not included | Presse-étoupes non incluíd

Todas as referências poderão ser fabricadas em:
Todas las referencias pueden ser fabricadas en:
All references may be manufactured in:
Toutes les références peuvent être fabriquées en:

M2 850°C

M0 960°C

Ex: J80-L ref. + M2 850°C = J80-L M2 ref.



SCAN + INFO



Acessórios | Accesorios | Accessories | Accessoires



Termoplástico
Termoplastico
Thermoplastic
Thermoplastique



-5°C
+60°C



Branco | Cinza | Creme | Preto
Blanco | Gris | Crema | Negro
White | Gray | Cream | Black
Blanc | Gris | Crème | Noir



399/5 ref.

Placa 3 Fases + N + T 500 V
Bornera 3 Fases + N + T 500 V
3 Phase Connector + N + E 500 V
Barrete 3 Pôles + N + T 500 V



Aplic. Ref. : J100* J160* J200*

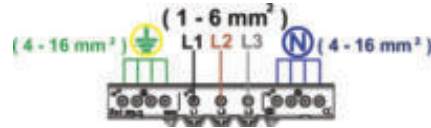

397/5 ref.

Placa de Bornes 3P+T+N
Bornera 3P+T+N
Pole Connector 3P+E+N
Barrete de connexion 3P+T+N
Min. 1,5 mm² - Max. 4 mm²



Aplic. Ref. : J100* J160*

397/3A ref.

Placa de Bornes 2P+T
Bornera 2P+T
Pole Connector 2P+E
Barrete de connexion 2P+T
Min. 1,5 mm² - Max. 4 mm²



Aplic. Ref. : J100* J160*

P5-273-5 ref.

Suporte p/ 5 ligadores 4P rápidos
Soporte p/ 5 conectores 4P rápidos
Support for 5, 4P fast connectors
Support pour 5 connecteurs rapides 4P

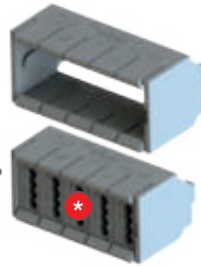

Aplic. Ref. : J80* J100* J160* J200*

* Não incluído | No incluido | Not included | Non inlucst

BM25 ref.

BM32 ref.

Boquilhas Métricas
Conos Metricos
Stepped rubber grommet Metric
Embouts à gradin Métrique



Ref.	Min. - Max. Ø	Ø (mm)	IP
BM25	Min. 3,5 mm - Max. 25 mm	30	66
BM32	Min. 3,5 mm - Max. 35 mm	37	66

MF83 ref.

MF106 ref.

MF132 ref.

MF170 ref.

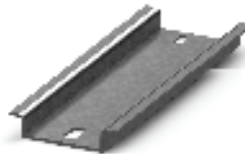

Calha DIN em aço zincado
Guia DIN en acero zincado
DIN Rail galvanized steel
Goulotte DIN acier zingué

Ref.	J100	J160	J200	Dim.
MF 83	A + B	A	-	83 mm
MF 106	-	B	-	106 mm
MF 132	-	-	A	132 mm
MF 170	-	-	B	170 mm

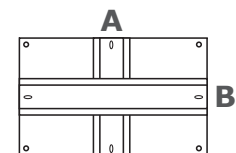

Aço Zincado
Acero Zincado
Zinc Plated Steel
Acier Zingué



SCAN + INFO



Termoplástico
Termoplastico
Thermoplastic
Thermoplastique



-5°C
+60°C



Autoextinguível
Autoextinguible
Self extinguishing
Autoextinguible



Teste Fio Incandescente
Prueba Hilo Incandescente
Glow Wire Test
Test of Fil Incandescent

Ref. + M0



960°

Ref. + M2



850°



Aplicação por pressão
Aplicación presión
Pressure application
Aplication à pression



Instalação com Cabos e Tubos
Instalación con Cables y Tubos
Installation with Cables and conduits
Installation avec de Câbles et Tubes



Secção Min-Max (mm²)
Sección Min-Max (mm²)
Min-Max section (mm²)



Nº de entradas
Nº de agujeros
Nº of entries
Nº de connections



SERIE FE CLASSIC



54

Caixas estanques para fio
Cajas estanca para hilo
Cable junction enclosures for wire
Boîtes de derivation étanches pour fil



FE25 ref.



FE7 ref.



FE12 ref.

FE15 ref.



SERIE FE CLASSIC

Ref		Dim. Int (mm)	IP	IK		
FE7	750°	75 x 75 x 37	54	07	7	1,5-4
FE12	750°	85 x 85 x 37	54	07	12	1,5-4
FE15	750°	100 x 100 x 37	54	07	12	1,5-4
FE25	750°	89 x 43 x 37	54	07	10	1,5-4

Todas as referências poderão ser fabricadas em:
Todas las referencias pueden ser fabricadas en:
All references may be manufactured in:
Toutes les références peuvent être fabriquées en:

M2 850°C

M0 960°C

Ex.: FE25 ref. + M2 850°C = FE25 M2 ref.



SCAN + INFO



Termoplástico
Termoplastico
Thermoplastic
Thermoplastique



-5°C
+60°C



Autoextinguível
Autoextinguible
Self extinguishing
Autoextinguible



Teste Fio incandescente
Prueba Hilo Incandescente
Glow Wire Test
Test de Fil Incandescent

Ref. + M0

960°

Ref. + M2

850°



Aplicação por pressão
Aplicación presión
Pressure application
Application à pression



Fecho com parafuso a 3/4
Cierre por tornillos a 3/4
Closed by screws at 3/4
Ferme par des vis a 3/4



Instalação com Cabos e Tubos
Instalación con Cables y Tubos
Installation with Cables and conduits
Installation avec de Cables et Tubes



Branco | Cinza | Creme | Preto
Blanco | Gris | Crema | Negro
White | Gray | Cream | Black
Blanc | Gris | Crème | Noir



Boquilhas IP 66
Conos IP 66
Grommets IP 66
Gradin IP66



Nº de entradas
Nº de agujeros
Nº of entries
Nº de connections



SCAN + INFO

SERIE 200 CLASSIC



Caixas estanques com boquilhas
Cable estancas con conos
Cable junction enclosures with stepped rubber grommets
Boîtes de dérivation étanches avec embouts à gradin



Ref.		Dim. Int (mm)	IP	IK		
219B	750°	80x45	54	08	4xPG21	3,5-23.5
220B	750°	80x80x50	54	08	7xPG16	3,5-20
222B	750°	100x100x55	54	09	6xPG21	3,5-23.5
221B	750°	150x110x70	54	09	10xPG21	3,5-23.5
223B	750°	175x110x65	54	09	10xPG21	3,5-23.5
223BTA	750°	175x110x83	54	09	10xPG21	3,5-23.5
225B	750°	190x150x70	54	09	10xPG21	3,5-23.5
225BTA	750°	190x150x83	54	09	10xPG21	3,5-23.5
224B	750°	220x170x120	54	09	10xPG29	3,5-32
226B	750°	220x170x105	54	09	10xPG29	3,5-32

* Boquilhas incluídas | Conos incluidos | Stepped Rubber Grommet included | Embouts à gradin inclus

Todas as referências poderão ser fabricadas em:
Todas las referencias pueden ser fabricadas en:
All references may be manufactured in:
Toutes les références peuvent être fabriquées en:

M2 850°C

M0 960°C

Ex.: 222B ^{ref.} + M2 850°C = 222B M2 ^{ref.}



Termoplástico
Termoplastico
Thermoplastic
Thermoplastique



-5°C
+60°C



Autoextinguível
Autoextinguible
Self extinguishing
Autoextinguible



Teste Fio Incandescente
Prueba Hilo Incandescente
Glow Wire Test
Test of Fil Incandescent

Ref. + M0

960°

Ref. + M2

850°



Entradas marcadas
Entradas marcadas
Premarked Entries
Entrées prédéconpées



Aplicação por pressão
Aplicación presión
Pressure application
Application à pression



Fecho com parafuso a 3/4
Cierre por tornillos a 3/4
Closed by screws at 3/4
Ferme par des vis a 3/4



Instalação com Cabos e Tubos
Instalación con Cables y Tubos
Installation with Cables and conduits
Installation avec de Câbles et Tubes



Branco | Cinza | Creme | Preto
Blanco | Gris | Crema | Negro
White | Gray | Cream | Black
Blanc | Gris | Crème | Noir



Nº de entradas
Nº de agujeros
Nº of entries
Nº de connexiones



Bucim Métrico
Prensaestopa Métrica
Metric Cable Gland
Presse-étoupe Métrique



SCAN + INFO

SERIE 200 CLASSIC



Caixas estanques com entradas marcadas (para uso de bucins PG)
Cajas estancas con entradas marcadas (para uso de prensaestopas PG)
Cable junction enclosures with pre-moulded knock-outs (for PG cable glands)
Boîtes de dérivation étanches (pour presse-étoupes PG)



Ref.		Dim. Int (mm)	IP	IK		
220A	750°	80x80x50	55	08	7xPG 16	11-14
222A	750°	100x100x55	65	09	6xPG 16	11-14
221A	750°	150x110x70	65	09	10xPG 16	11-14
223A	750°	175x110x65	65	09	10xPG 16	11-14
223ATA	750°	175x110x83	65	09	10xPG 16	11-14
225A	750°	190x150x70	65	09	2xPG29+8xPG21	18-25 + 14-18
225ATA	750°	190x150x83	65	09	2xPG29+8xPG21	18-25 + 14-18
224A	750°	220x170x120	65	09	2xPG29+8xPG21	18-25 + 14-18
226A	750°	220x170x105	65	09	2xPG29+8xPG21	18-25 + 14-18

Todas as referências poderão ser fabricadas em:
Todas las referencias pueden ser fabricadas en:
All references may be manufactured in:
Toutes les références peuvent être fabriquées en:

M2 850°C

M0 960°C

Ex.: 222A ^{ref.} + M2 850°C = 222A M2 ^{ref.}



Termoplástico
Termoplastico
Thermoplastic
Thermoplastique



-5°C
+60°C



Autoextinguível
Autoextinguible
Self extinguishing
Autoextinguible



Teste Fio Incandescente
Prueba Hilo Incandescente
Glow Wire Test
Test of Fil Incandescent

Ref. + M0

960°

Ref. + M2

850°



Entradas marcadas
Entradas marcadas
Premarked Entries
Entrées pré-déconpées



Fecho com parafuso a 3/4
Cierre por tornillos a 3/4
Closed by screws at 3/4
Ferme par des vis a 3/4



Instalação com Cabos e Tubos
Instalación con Cables y Tubos
Installation with Cables and conduits
Installation avec de Câbles et Tubes



Branco | Cinza | Creme | Preto
Blanco | Gris | Crema | Negro
White | Gray | Cream | Black
Blanc | Gris | Crème | Noir

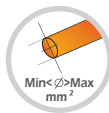

Secção Min-Max (mm²)
Sección Min-Max (mm²)
Min-Max section (mm²)



Buçin Métrico
Prensaestopa Métrica
Metric Cable Gland
Presse-étoupe Métrique



Nº de entradas
Nº de agujeros
Nº of entries
Nº de connections



SCAN + INFO

SERIE 200 CLASSIC



Caixas estanques com entradas marcadas (para uso de buçins metricos)
Cajas estancas con entradas marcadas (para uso de prensaestopas metricas)
Cable junction enclosures with pre-moulded knock-outs (for metric cable glands)
Boîtes de derivation étanches (pour presse-étoupes métriques)



Ref.		Dim. Int (mm)	IP	IK		\varnothing
220-AM	750°	80x80x50	55	08	7xM20	8-13
222-AM	750°	100x100x55	65	09	6xM20/M25	8-13 / 12-18
221-AM	750°	150x110x70	65	09	6xM20+4xM25	8-13 / 12-18
223-AM	750°	175x110x65	65	09	10xM20/M25	8-13 / 12-18
223-ATAM	750°	175x110x83	65	09	6xM20+4xM25	8-13 / 12-18
225-AM	750°	190x150x70	65	09	4xM20+6xM25	8-13 / 12-18
225-ATAM	750°	190x150x83	65	09	6xM20+4xM25	8-13 / 12-18
224-AM	750°	220x170x120	65	09	10xM25	12-18
226-AM	750°	220x170x105	65	09	10xM25	12-18

Todas as referências poderão ser fabricadas em:
Todas las referencias pueden ser fabricadas en:
All references may be manufactured in:
Toutes les références peuvent être fabriquées en:

M2 850°C

M0 960°C

Ex.: 220-AM ^{ref.} + M2 850°C = 220-AM M2 ^{ref.}



Termoplástico
Termoplastico
Thermoplastic
Thermoplastique



-5°C
+60°C



Autoextinguível
Autoextinguible
Self extinguishing
Autoextinguible



Teste Fio incandescente
Prueba Hilo Incandescente
Glow Wire Test
Test of Fil Incandescent

Ref. + M0 960°

Ref. + M2 850°



Fecho com parafuso a 3/4
Cierre por tornillos a 3/4
Closed by screws at 3/4
Ferme par des vis a 3/4



Branco | Cinza | Creme | Preto
Blanco | Gris | Crema | Negro
White | Gray | Cream | Black
Blanc | Gris | Crème | Noir



Chave
Llave
Key
Clé



Bucim PG
Prensaestopa PG
PG Cable Gland
Presse-étoupe PG



Bucim Métrico
Prensaestopa Métrica
Metric Cable Gland
Presse-étoupe Metrique



SERIE 200 CLASSIC



Caixas estanques com paredes lisas
Cajas estancas con paredes lisas
Cable junction enclosures with plain walls
Boites de dérivation étanches non percées



Ref.		Dim. Int (mm)	IP	IK
220L	750°	80x80x50	55	08
222L	750°	100x100x55	65	09
221L	750°	150x110x70	65	09
223L	750°	175x110x65	65	09
223LTA	750°	175x110x83	65	09
225L	750°	190x150x70	65	09
225LTA	750°	190x150x83	65	09
224L	750°	220x170x120	65	09
226L	750°	220x170x105	65	09
MF-242	750°	322x275x185	65	09
MF-244	750°	422x380x185	54	09

Todas as referências poderão ser fabricadas em:
Todas las referencias pueden ser fabricadas en:
All references may be manufactured in:
Toutes les références peuvent être fabriquées en:

M2 850°C

M0 960°C

Ex.: 224L ^{ref.} + M2 850°C = 224L M2 ^{ref.}



SCAN + INFO



Termoplástico
Termoplastico
Thermoplastic
Thermoplastique



-5°C
+60°C



Autoextinguível
Autoextinguible
Self extinguishing
Autoextinguible



Teste Fio incandescente
Prueba Hilo Incandescente
Glow Wire Test
Test de Fil Incandescent

Ref. + M0
960°
Ref. + M2
850°



Entradas marcadas
Entradas marcadas
Premarked Entries
Entrées prédéconpées



Instalação com Cabos e Tubos
Instalación con Cables y Tubos
Installation with Cables and conduits
Installation avec de Cables et Tubes



Bucin PG
Prensaestopa PG
PG Cable Gland
Presse-étoupe PG



Bucin Métrico
Prensaestopa Métrica
Metric Cable Gland
Presse-étoupe Métrique



Nº de entradas
Nº de agujeros
Nº of entries
Nº de connections



Chave
Llave
Key
Clé



SERIE 200 CLASSIC

TRANS.

Caixas estanques com tampa transparente
Cajas estancas con tapa transparente
Cable junction enclosures with transparent lid
Boîtes de dérivation étanches à couvercle transparent



IP 65



Ref.		Dim. Int (mm)	IP	IK			
221ATR	750°	150x110x70	65	05		10xPG16	11-14
221AMTR	750°	150x110x70	65	05		6xM20 + 4xM25	8-13 + 12-18
221BTR	750°	150x110x70	54	05		10xPG21	3,5-23,5
221LTR	750°	150x110x70	65	05	-	-	-
223ATR	750°	175x110x65	65	05		10xPG16	11-14
223AMTR	750°	175x110x65	65	05		10xM20/M25	8-13 / 12-18
223BTR	750°	175x110x65	54	05		10xPG21	3,5-23,5
223LTR	750°	175x110x65	65	05	-	-	-
223ATATR	750°	175x110x83	65	05		10xPG16	11-14
223ATAMTR	750°	175x119x83	65	05		10xM20/M25	8-13 / 12-18
223BTATR	750°	175x110x83	54	05		10xPG21	3,5-23,5
223LTATR	750°	175x110x83	65	05	-	-	-
225ATR	750°	190x150x70	65	05		6xM20+4xM25	8-13 + 12-18
225AMTR	750°	190x150x70	65	05		6xM20+4xM25	8-13 + 12-18
225BTR	750°	190x150x70	54	05		10xPG21	3,5-23,5
225LTR	750°	190x150x70	65	05	-	-	-
225ATATR	750°	190x150x83	65	05		2xPG29+8xPG21	18-25 + 14-18
225ATAMTR	750°	190x150x83	65	05		6xM20+4xM25	8-13 + 12-18
225BTATR	750°	190x150x83	54	05		10xPG21	3,5-23,5
225LTATR	750°	190x150x83	65	05	-	-	-
224ATR	750°	220x170x120	65	05		2xPG29+8xPG21	18-25 + 14-18
224AMTR	750°	220x170x120	65	05		10xM25	14-25
224BTR	750°	220x170x120	54	05		2xPG29+8xPG21	3,5-32 + 3,5-23,5
224LTR	750°	220x170x120	65	05	-	-	-
226ATR	750°	220x170x105	65	05		2xPG29+8xPG21	18-25 + 14-18
226AMTR	750°	220x170x105	65	05		10xM25	14-25
226BTR	750°	220x170x105	54	05		2xPG29+8xPG21	3,5-32 + 3,5-23,5
226LTR	750°	220x170x105	65	05	-	-	-
MF-242TR	750°	322x275x185	65	05	-	-	-
MF-242TRP	750°	322x275x185	65	10	-	-	-
MF-244TR	750°	422x380x185	54	05	-	-	-
MF-244TRP	750°	422x380x185	54	10	-	-	-

* Boquillas incluidas | Conos incluidos | Stepped Rubber Grommet included | Embouts à gradin inclus

Todas as referências poderão ser fabricadas em:
Todas las referencias pueden ser fabricadas en:
All references may be manufactured in:
Toutes les références peuvent être fabriquées en:

M2 850°C

M0 960°C

Ex.: 221ATR ^{ref.} + M2 850°C = 221ATR M2 ^{ref.}



SCAN + INFO



Termoplástico
Termoplastico
Thermoplastic
Thermoplastique



-5°C
+60°C



Autoextinguível
Autoextinguible
Self extinguishing
Autoextinguible



Teste Fio Incandescente
Prueba Hilo Incandescente
Glow Wire Test
Test de Fil Incandescent

Ref. + M0

960°

Ref. + M2

850°



Parafusos aço
Tornillos acero
Metalic screws
Vis metalique



Instalação com Cabos e Tubos
Instalación con Cables y Tubos
Installation with Cables and conduits
Installation avec de Câbles et Tubes



Secção Min-Max (mm²)
Sección Min-Max (mm²)
Min-Max section (mm²)



Nº de entradas
Nº de agujeros
Nº of entries
Nº de connections



Bucim PG
Prensaestopa PG
PG Cable Gland
Presse-étoupe PG



Bucim Métrico
Prensaestopa Métrica
Metric Cable Gland
Presse-étoupe Metrique



SCAN + INFO

SERIE 300 CLASSIC



54

Caixa estanque com entradas marcadas (p/uso de bucins métricos) e parafusos em aço
Caja estanca con entradas marcadas (p/uso de prensaestopas metricas) y tornillos en acero
Cable junction enclosure with pre-moulded knock-outs (for use metric cable glands) and steel screws
Boîte de dérivation étanche (pour presse-étoupes métriques) avec vis en acier



Ref.		Dim. Int (mm)	IP	IK		
320	750°	80x80x37	54	08	8x PG13,5 / M20	14-25



SERIE 600 CLASSIC

PG 13,5
M20



54

Caixa estanque com entradas marcadas (p/uso de bucins PG e Metricos) e parafusos em aço
Caja estanca con entradas marcadas (p/uso de prensaestopas PG y metricas) y tornillos en acero
Cable junction enclosure with pre-moulded knock-outs (for use PG and Metric cable glands) and steel screws
Boîte de dérivation étanche (pour presse-étoupes PG et métriques) avec vis en acier



Ref.		Dim. Int (mm)	IP	IK		
620	750°	86x86x34	54	08	8x PG13,5 / M20	14-25

Inclui placa de 5 bornes (Ref. 397/5)
Inclui placa de 5 bornes (Ref. 397/5)
Includes 5 pole connector (Ref. 397/5)
Inclus barrette de connexion 5 poles (Ref. 397/5)

399/5 ref.





Termoplástico
Termoplastico
Thermoplastic
Thermoplastique



Cores disponíveis
Colores disponibles
Available Colors
Couleurs Disponibles

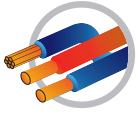

Para usar com Cabos
Para uso con Cables
To use with Cables
Utiliser avec de Câbles



Bucins PG | Prensaestopas PG
PG cable glands | Presse-étoupes PG



-5°C
+60°C



Ref.	Ø (mm)	IP	IK	Ø
PG7	13/15	65	07	3,5-6
PG9	16/19	65	07	4,5-7
PG11	19/22	65	07	6-9
PG13,5	21/24	65	07	9-12
PG16	23/27	65	07	11-14
PG21	30/33	65	07	14-18
PG29	40/42	65	07	18-25
PG36	50/53	65	07	25-32
PG48	60/65	65	07	38-44
313	23/27 24/27	65	07	11-14 8-13

Bucim Híbrido (PG16/M20) | Prensaestopas Híbrido (PG16/M20)
Hybrid Glands (PG16/M20) | Presse-étoupes Hybride (PG16/M20)



Bucins métricos | Prensaestopas métricas
Metric cable glands | Presse-étoupes métriques



-20°C
+90°C



Ref.	Ø (mm)	IP	IK	Ø
M12	15/16,5	68	09	3-6,5
M16	19/21	68	09	6-10
M20	24/27	68	09	8-13
M25	33/37,5	68	09	12-18
M32	42/47,5	68	09	16-20
M40	53/60	68	09	20-29
M50	60/68	68	09	26-34
M63	65/74	68	09	34-44

Porcas PG | Tuercas PG
PG Nuts | Écrous PG

Porcas métricas | Tuercas métricas
Metric nuts | Écrous métriques

Ref.	Ø (mm)
PG7-P	19
PG9-P	22
PG11-P	24
PG13,5-P	27
PG16-P	30
PG21-P	36
PG29-P	46
PG36-P	60
PG48-P	70



Ref.	Ø (mm)
M12-P	15
M16-P	19
M20-P	24
M25-P	33
M32-P	42
M40-P	53
M50-P	60
M63-P	65



SCAN + INFO



Termoplástico
Termoplastico
Thermoplastic
Thermoplastique



-5°C
+60°C



Branco | Cinza | Creme | Preto
Blanco | Gris | Crema | Negro
White | Gray | Cream | Black
Blanc | Gris | Crème | Noir

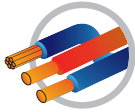

Para usar com Cabos
Para uso con Cables
To use with Cables
Utiliser avec de Câbles



Instalação com Tubos
Instalación con Tubos
Installation with Conduits
Installation avec de Tubes



Diâmetro de corte
Diámetro de corte
Cutting diameter
Diamètre de coupe



Tampões PG | Tapas PG | PG blind nuts | Bouchons PG



Ref.	(mm)	Ø (mm)
PG7-T	19	15,0
PG9-T	22	19,0
PG11-T	24	22,0
PG13,5-T	27	25,0
PG16-T	30	27,0
PG21-T	36	33,0
PG29-T	46	44,0
PG36-T	60	55,0
PG48-T	70	69,0



Boquilhas PG | Conos PG
Stepped rubber PG grommet | Embouts à gradin PG



Ref	Ø (mm)	Ø (mm)	IP
PG16-B	3,5 - 20,0	23	54
PG21-B	3,5 - 23,5	28,5	54
PG29-B	3,5 - 32,0	38	54

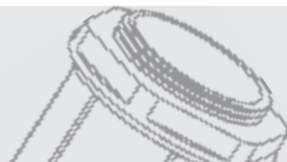

Boquilhas roscadas com porca
Racores tubo/caja con tuerca
Simple straight tight pipe-sheath fitting
Raccords de fixation tube boîte



Ref.	Ø Ext. (mm)	(mm)	(mm)	PG / Metric	Ø
R16-HF	16	VD 16	24	PG11	19
R16-MHF	16	VD 16	24	M16	16
R20-HF	20	VD 20	30	PG16	23
R20-MHF	20	VD 20	30	M20	20
R1620-HF	16-20	VD 16/VD 20	30	PG13,5/M20	19 / 23
R25-HF	25	VD 25	36	PG21	29
R25-MHF	25	VD 25	36	M25	25
R32-HF	32	VD 32	41	M32	32
R40-HF	40	VD 40	30	M40	40
R50-HF	50	VD 50	60	M50	50
R63-HF	63	VD 63	75	M63	65



SCAN + INFO



Termoplástico
Termoplastico
Thermoplastic
Thermoplastique



-5°C
+90°C



Bornes
Bornes
Connectors
Conecteurs



Cinza | Preto
Gris | Negro
Gray | Black
Gris | Noir

Conector de torção (TORIX)
Conector de torsión
Twist Nuts Caps
Écrous torsadés



Ref	850°	N°	Mín. → Max. mm²	
			mm²	N°
362	850°	1	2,5	2
			1,5	2 - 3
			1	2 - 4
			0,75	2 - 4



Placas de bornes / Torix
Placas de bornes / Capuchon
Terminais / Twist-on connector
Barretes de conexão / Connecteur par épissure

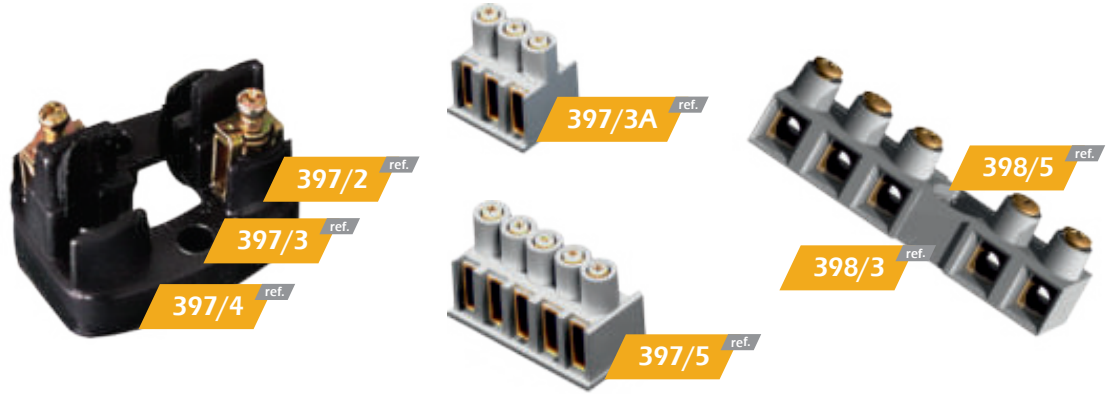

Ref	850°	N°	Mín. → Max. mm²
397/2	850°	2	1,5 - 4
397/3	850°	3	1,5 - 4
397/4	850°	4	1,5 - 4
397/3A	850°	3	1,5 - 4
397/5	850°	5	1,5 - 4
398/3	850°	3	2,5
398/5	850°	5	2,5



SCAN + INFO



Termoplástico
Termoplastico
Thermoplastic
Thermoplastique



-5°C
+60°C



Bornes
Bornes
Connectors
Conecteurs



Cinza | Creme
Gris | Crema
Grey | Cream
Gris | Crème

Caixas de derivação c/bornes
Cajas de derivación c/ borneras
Cable junction boxes w/pilar terminals
Boîtes de dérivation avec connecteurs



Parafusos aço
Tornillos acero
Metalic screws
Vis metalique



Ref	850°	Dim. (mm)	N°	Mín. → Max. mm²
325/2	850°	60 x 60 x 30	2	1,5 - 4
325/3	850°	60 x 60 x 30	3	1,5 - 4
325/4	850°	60 x 60 x 30	4	1,5 - 4



SOLEFLEX

by JSL

O LIGADOR RÁPIDO SOLFLEX DA JSL É
UMA SOLUÇÃO ÚNICA NO MERCADO.
SEGURO, ROBUSTO E MUITO
SIMPLES DE MANUSEAR.

THE JSL SOLFLEX QUICK CONNECTOR IS
A UNIQUE SOLUTION IN THE MARKET.
SAFE, ROBUST AND VERY
EASY TO HANDLE.

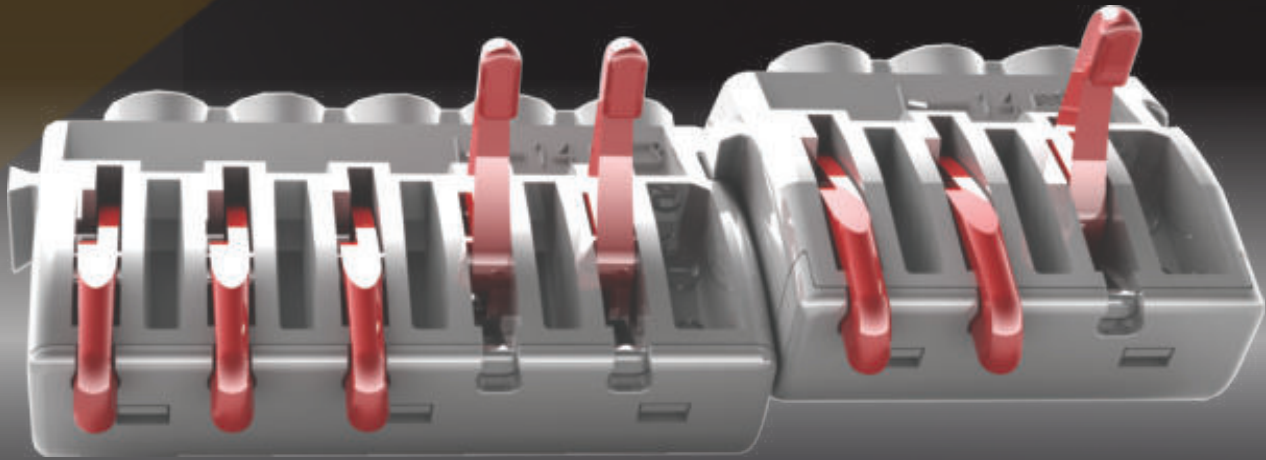

50% + RÁPIDO

A INSTALAÇÃO DE FIOS ELÉTRICOS
NUNCA FOI TÃO FÁCIL!

50% + FASTER

THE ELECTRICAL WIRES INSTALLATION
HAS NEVER BEEN SO EASY!

VANTAGENS BENEFITS

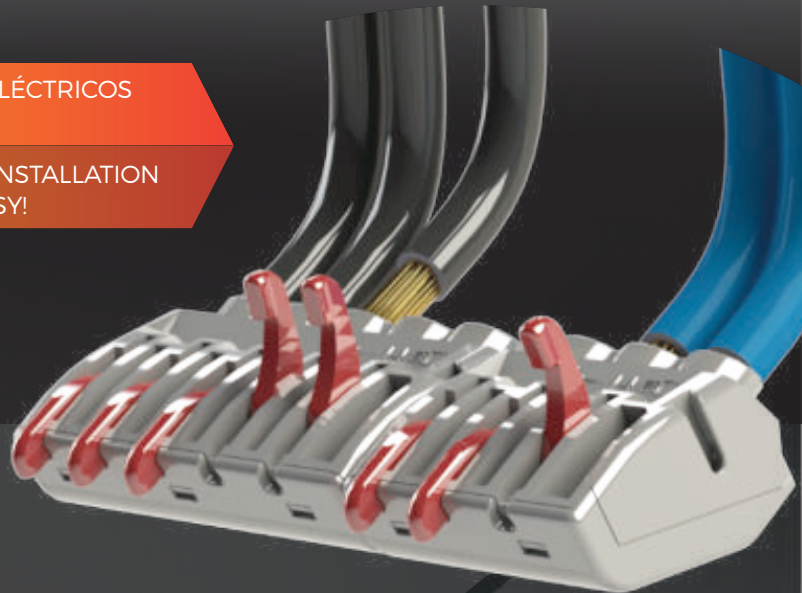

ROBUSTO E SIMPLES DE INSTALAR
RUGGED AND SIMPLE TO INSTALL

LIGAÇÃO POSSÍVEL COM CONDUTOR RÍGIDO OU FLEXÍVEL
POSSIBLE CONNECTION WITH RIGID OR FLEXIBLE CONDUCTOR

ENCAIXÁVEL NELE PRÓPRIO FORMANDO REGUA DE BORNES COM DIFERENTES POLARIDADES
ATTACHABLE TO ITSELF FORMING A TERMINAL STRIP WITH DIFFERENT POLARITIES

MISTURA BASEADA EM MATERIAL AUTO EXTINGUIVEL, RETARDANTE DE
CHAMA AMBIENTALMENTE SEGURA E SEM SUBSTÂNCIAS NOCIVAS
MIXING BASED ON AUTO EXTINGUIVEL MATERIAL, ENVIRONMENTALLY
SAFE FLAME RETARDANT AND NO NOXY SUBSTANCES

VASTA AMPLITUDE DE TEMPERATURA DE -5°C A + 40°C PERMITE
TRABALHOS ELÉTRICOS EM AMBAS AS CONDIÇÕES QUENTES E FRIAS,
SEM PERDA DAS PROPRIEDADES MECÂNICAS E DE ISOLAMENTO
WIDE TEMPERATURE RANGE FROM -5°C A + 40°C ALLOWS
ELECTRICALWORK IN BOTH HOT AND COLD CONDITIONS
WITHOUT LOSS OF MECHANICAL AND INSULATION PROPERTIES

RoHS

Auto
Extinguível

REACH

-5°C
+40°C

NÃO NECESSITA
DE FERRAMENTAS



DOES NOT
REQUIRE TOOLS

NÃO MAGOA
OS DEDOS



DOES NOT
HURT THE FINGERS

LIVRE DE HALOGÊNIO
E FÓSFORO



HALOGEN AND
PHOSPHORUS FREE

LIVRE

HALÓGENEOS

WE CARE



JSL
Material Eléctrico



Termoplástico
Termoplastico
Thermoplastic
Thermoplastique



-5°C
+40°C



Autoextinguível
Autoextinguible
Self extinguishing
Autoextinguible



Cinza
Gris
Gray
Gris

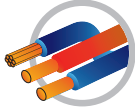

Para usar com Cabos
Para uso con Cables
To use with Cables
Utiliser avec de Câbles



SOLEFLEX by JSL

Ligadores rápidos (condutores rígidos e flexíveis)
Conectores rápidos (condutores flexíveis y rígidos)
Push wire connectors (rigid and flexible conductors)
Conecteurs rapides (conducteurs rigides et souples)

Não necessita de ferramentas
Não magoa os dedos
No tools required
Does not hurt your fingers

Fecho de Segurança
Safety Lock

Medidor de descarte ideal
Ideal wire size measure slot

Orifício para teste
Test Hole

Simple to install (redução de 50% no tempo de instalação)
Ligação possível com condutor rígido ou flexível.

Simple to install (50% reduction in installation time)
Possible connection with rigid or flexible conductor.

Ref		Amp.	Nº Ent.	Volts	Min. >Max mm ²
222-3	850°	24	3	450	Min. 0,5 - Max. 4 mm
222-5	850°	24	5	450	Min. 0,5 - Max. 4 mm



Ligadores rápidos (condutores rígidos)
Conectores rápidos (condutores rígidos)
Push wireconnectors (rigid conductors)
Conecteurs rapides (conducteurs rigides)



N273-103 ref.

N273-104 ref.

N273-105 ref.

Ref		Amp.	Nº	Volts	Min. >Max mm ²
273-102	850°	24	2	450	Min. 1- Max. 2,5 mm ²
N273-103	850°	24	3	450	Min. 1- Max. 2,5 mm ²
N273-104	850°	24	4	450	Min. 1- Max. 2,5 mm ²
N273-105	850°	24	5	450	Min. 1- Max. 2,5 mm ²



SCAN + INFO

CAIXAS PARA INSTALAÇÕES ESPECIAIS

Cajas para instalaciones especiales
Boxes for special installations
Boîtes pour installations spéciales

**POWER
RESIN**



**POWER
GEL**



E90
FIRE RESISTANT

GreenBox





Termoplástico
Termoplastico
Thermoplastic
Thermoplastique



-5°C
+60°C



Autoextinguível
Autoextinguible
Self extinguishing
Autoextinguible



Teste Fio incandescente
Prueba Hilo Incandescente
Glow Wire Test
Test de Fil Incandescent



3/4
Fecho com parafuso a 3/4
Cierre por tornillos a 3/4
Closed by screws at 3/4
Ferme par des vis a 3/4



Instalação com Cabos e Tubos
Instalación con Cables y Tubos
Installation with Cables and conduits
Installation avec de Câbles et Tubes



Verde
Verde
Green
Vert



Min\varnothing-Max
mm²
Sección Min-Max (mm²)
Sección Min-Max (mm²)
Min-Max section (mm²)



Bucin Métrico
Prensaestopa Métrica
Metric Cable Gland
Presse-étoupe Metrique



CAIXA DE JARDIM | GREENBOX J100S-EXT ^{ref.}

Caixas estanques para instalação em estufas / zonas verdes / jardins e solo aquecido
Cajas estancas para instalación en invernaderos / ubicación verdes / jardines y suelo radiante
Watertight boxes for installation in green houses / green areas / gardens and heated soil
Boîtes étanches à installer dans des serres / espaces verts / jardins et sols chauffés



Parafusos 3/4 para acesso fácil e rápido
Tornillos 3/4 para acceso fácil y rápido
3/4 screws for easy and quick access
Vis 3/4 pour un accès facile et rapide



3x

M20 (3 x incl.)



SCAN + INFO

Ref		Dim. Int (mm)	IP	IK			Min\varnothing-Max mm ²
J100S-EXT	750°	102 x 102 x 55	66	08	7 x M20	8 - 13	1,5-6

POWER GEL

O POWER GEL DA JSL É A SOLUÇÃO PERFEITA PARA PROTECÇÃO EXTRA DE CAIXAS DE DERIVAÇÃO ESTANQUES EM INSTALAÇÕES ELÉCTRICAS E DE TELECOMUNICAÇÕES.

THE JSL POWER GEL IS THE PERFECT SOLUTION FOR EXTRA PROTECTION OF WATERTIGHT JUNCTION BOXES IN ELECTRICAL AND TELECOMMUNICATIONS INSTALLATIONS.



Elevada Protecção Anti-UV
High Anti-UV protection

CARACTERÍSTICAS

FEATURES

- RESISTÊNCIA DE ISOLAMENTO $\Omega 10^{14}$
INSULATION RESISTANCE $\Omega 10^{14}$
- SELAGEM (Instalações em ambientes húmidos)
SEALING (Installations in humid environments)
- DESEMPENHO TÉRMICO (Normal 90°C, Sobrecarga 140°C)
THERMAL PERFORMANCE (Normal 90°C, Overload 130°C)
- ELEVADO GRAU DE PROTECÇÃO MESMO COM ÁGUA ENTRE OS CONDUTORES DO CABO
HIGH DEGREE OF PROTECTION EVEN WITH WATER BETWEEN THE CABLE CONDUCTORS

VANTAGENS

BENEFITS

IP68

GEL

- >23 KV/MM
RIGIDEZ DIELECTRICA
DIELECTRIC RIGIDITY
- IP 68
GRAU DE PROTECÇÃO
DEGREE OF PROTECTION
- 40°C
+140°C
TEMPERATURA DE FUNCIONAMENTO
OPERATING TEMPERATURE
- ADEQUADO PARA EXTREMA HUMIDADE
SUITABLE FOR EXTREME HUMIDITY
- +/-10 MIN.
RETICULAÇÃO RÁPIDA
QUICK RETICULATION

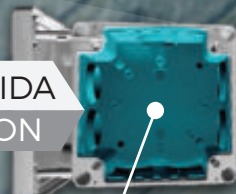

FLEXÍVEL E REMOVÍVEL
FLEXIBLE AND REMOVABLE



RESISTÊNCIA À ÁGUA > 0,01 MPa
WATER PROOF > 0,01 MPa

GEL COM PROPRIEDADES DE MEMÓRIA
GEL WITH MEMORY PROPERTIES





Termoplástico
Termoplastico
Thermoplastic
Thermoplastique



-5°C
+60°C



Retardante de chama
Retardante de llama
Flame retardant
Retardateur de flamme



3/4
Fecho com parafuso a 3/4
Cierre por tornillos a 3/4
Closed by screws at 3/4
Ferme par des vis a 3/4



Instalação com Cabos e Tubos
Instalación con Cables y Tubos
Installation with Cables and conduits
Installation avec de Câbles et Tubes

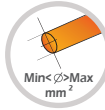

Secção Min-Max (mm²)
Sección Min-Max (mm²)
Min-Max section (mm²)



Bucim Métrico
Prensaestopa Métrica
Metric Cable Gland
Presse-étoupe Métrique



Branco | Cinza | Creme | Preto
Blanco | Gris | Crema | Negro
White | Gray | Cream | Black
Blanc | Gris | Crème | Noir



Protecção anti-UV
Protección contra-UV
Anti-UV protection
Protection contre-UV



SCAN + INFO

Caixas estanques IP68 | Cajas IP68 estancas | IP68 waterproof boxes | Boîtes étanches IP68

NOVO
NEW

POWER GEL

IP68 GEL



J100S GKIT:
Solução POWER GEL para protecção extra de caixas de derivação estanques em instalações eléctricas e de telecomunicações em:

Aplicações em ambientes de humidade extrema ou instalações enterradas, poços, estações de bombagem de serviço e de lavagem, piscinas, entre outros.

Fornecida com duas embalagens de gel de proporção 1 para 1. Mistura simples e rápida. Sem halogéneos, sem silicone, sem isocianatos ou outros contaminantes.

J100S GKIT:
Solución POWER GEL para protección adicional de cajas estancas de las instalaciones eléctricas y de telecomunicaciones:

Protección de la humedad extrema, o instalaciones subterráneas, pozos, estaciones de bombeo, estaciones de servicio y de lavado, piscinas, entre otras aplicaciones.

Provisto de dos contenedores de gel, relación 1 a 1 de mezcla simple y rápida. Libre de halógenos, sin silicón, sin isocianatos u otros contaminantes.

J100S GKIT:
POWER GEL solution for extra protection watertight junction boxes to electrical and telecommunications installations:

Extreme humidity environments applications or buried installations, wells, pumping stations, service stations and washing, swimming pools, among others.

Provided with two containers of gel, ratio 1 to 1, simple and fast mix. Halogen-free, silicone-free, no isocyanates or other contaminants.

J100S GKIT:
Solution POWER GEL pour la protection supplémentaire des boîtes étanches d'installations électrique et de télécommunications:

Pour des environnements d'humidité extrême ou des installations souterraines, des puits, des stations de pompage les stations service et de lavage, des piscines, entre autres.

Fourni avec deux conteneurs de gel, de taux 1 à 1, mélange simple et rapide. Sans halogène, sans silicone, ni isocyanates ou d'autres contaminants.

Ref		Dim. Int (mm)	IP	IK			
J100S GKIT	750°	102 x 102 x 55	68	08	7 x M20	8 - 13	1,5-6

NOVO
NEW

POWER RESIN

IP68 RESIN



J100S IKIT:
Caixa estanque IP68 com resina para imersão continua em água. Para exteriores ou imersão total e continua até 10m de profundidade.

Kit de resina de poliuretano fácil de usar e misturar.

A caixa J100S IKIT FR é fornecida com resina de PU (retardante de chama).

J100S IKIT:
Caja estanca IP68 con resina para inmersión continua en agua. Para exterior o inmersión total y continúa hasta 10m de profundidad.

Kit de uso sencillo y facil mezcla, en resina de poliuretano.

A caja J100S IKIT FR se entrega con resina de PU (retardante de llama).

J100S IKIT:
Waterproof Box IP68 for continues immersion in water. For outdoors or continuous and total imersion until 10 meters deep.

The Kit is made of polyurethane resin and is easy to use and to mix.

The J100S IKIT box FR is provided with PU resin (flame retardant).

J100S IKIT:
Boîtier étanche IP68 pour immersion continue dans de l'eau. Pour extérieur ou l'immersion totale et poursuit jusqu'à 10 m profondeur.

Kit facile à utiliser et mélanger en résine de polyuréthane. Les boîtes.

J100S IKIT sont fournis avec de la résine PU (retardateur de flamme).

Ref		Dim. Int (mm)	IP	IK			
J100S IKIT	750°	102 x 102 x 55	68	08	7 x M20	8 - 13	1,5-6
J100S IKIT FR	750°	102 x 102 x 55	68	08	7 x M20	8 - 13	1,5-6

POWER RESIN



O POWER RESIN DA JSL É A SOLUÇÃO PERFEITA PARA INSTALAÇÕES DE ILUMINAÇÃO PÚBLICA, ÁREAS SUBMERSÍVEIS E NA SALVAGUARDA DE INSTALAÇÕES ELÉTRICAS

THE JSL POWER RESIN IS THE PERFECT SOLUTION FOR PUBLIC LIGHTING INSTALLATIONS, SUBMERSIBLE AREAS AND THE SAFEGUARD OF ELECTRIC INSTALLATIONS

CARACTERÍSTICAS FEATURES

ALTA RESISTÊNCIA AO IMPACTO
HIGH IMPACT RESISTANCE

ISOLAMENTO (Tensões elevadas)
ISOLAMENTO (TENSÕES ELEVADAS)

EPOXI COM UM BAIXO TEMPO DE CURA
EPOXY WITH LOW CURING TIME

VISCOSIDADE PERFEITA PARA ESTANCAMENTO DE JUNTAS E CAVIDADES
PERFECT VISCOSITY FOR CASTING JOINTS AND OTHER FILLING OBJECTS

VANTAGENS BENEFITS

>20
N/mm²

RESISTENCIA À TENSÃO
TENSILE STRENGTH

IP
68

GRAU DE PROTECÇÃO
DEGREE OF PROTECTION

16-35
MIN.

TEMPO DE CURA
CURING TIME



ADEQUADO PARA EXTREMA HUMIDADE
SUITABLE FOR EXTREME HUMIDITY

70
SHORE D

GRAU DE DUREZA
HARDNESS

IP68

RESIN

INSTALACÇÃO ATÉ 10 METROS DEBAIXO DE ÁGUA
INSTALLATION UP TO 10 METERS UNDER WATER



Termoplástico
Termoplastico
Thermoplastic
Thermoplastique



-5°C
+60°C



Autoextinguível
Autoextinguible
Self extinguishing
Autoextinguible



Teste Fio incandescente
Prueba Hilo Incandescente
Glow Wire Test
Test de Fil Incandescent

Ref. + M0 960°

Ref. + M2 850°



Cinza
Gris
Gray
Gris



Fecho com parafuso a 3/4
Cierre por tornillos a 3/4
Closed by screws at 3/4
Ferme par des vis a 3/4



Instalação com Cabos e Tubos
Instalación con Cables y Tubos
Installation with Cables and conduits
Installation avec de Câbles et Tubes

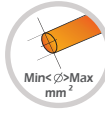

Secção Min-Max (mm²)
Sección Min-Max (mm²)
Min-Max section (mm²)



Boquilhas IP 66
Conos IP 66
Grommets IP 66
Gradin IP66



SCAN + INFO

Caixas estanques IP68 | Cajas IP68 estancas | IP68 waterproof boxes | Boîtes étanches IP68



POWER GEL

IP68 GEL

Ex:



Ref	□	Dim. Int (mm)	GA (ml)	IP	🔌 +	🔑 Min->Max mm ²	🔗	🌀 Ø
J80-BGAK	4 ²	83 x 83 x 50	340 ml	68	7 x M25	1,5-4	750°	3,5-25
J100-BGAK	6 ²	102x102x55	500 ml	68	7 x M25	1,5-6	750°	3,5-25
J160-BGAK	10 ²	102 x 152 x 65	900 ml	68	10 x M25	1,5-10	750°	3,5-25
J200-BGAK	16 ²	152 x 202 x 85	1200 ml	68	10 x M32	1,5-16	750°	3,5-32

* Boquilhas incluídas | Conos incluidos | Stepped Rubber Grommet included | Embouts à gradin inclut



POWER RESIN

IP68 RESIN

Ex:



Kit de caixas estanques com resina / gel apropriadas para uso directo de cabos subterrâneos. Também para instalações sanitárias, instalações portuárias, túneis e áreas de inundação.

Kit de cajas con resina / gel adecuado para el uso directo de cable subterráneo. También para instalaciones de lavado, instalaciones portuarias, túneles y áreas de inundación.

Kit of boxes with resin / gel suitable for direct underground cable. Also for washing facilities, port installations, tunnels and flooding areas.

Kit des boîtes avec de la résine / gel adapté à une utilisation directe de câble souterrain. Aussi pour les installations de lavage, installations portuaires, des tunnels et des zones inondables.

Ref	□	Dim. Int (mm)	GA (ml)	IP	🔌 +	🔑 Min->Max mm ²	🔗	🌀 Ø
J80-BGA	4 ²	83 x 83 x 50	340 ml	68	7 x M25	1,5-4	750°	3,5-25
J100-BGA	6 ²	102x102x55	500 ml	68	7 x M25	1,5-6	750°	3,5-25
J160-BGA	10 ²	102 x 152 x 65	900 ml	68	10 x M25	1,5-10	750°	3,5-25
J200-BGA	16 ²	152 x 202 x 85	1200 ml	68	10 x M32	1,5-16	750°	3,5-32

* Boquilhas incluídas | Conos incluidos | Stepped Rubber Grommet included | Embouts à gradin inclut



Termoplástico
Termoplastico
Thermoplastic
Thermoplastique



-15°C
+45°C



Autoextinguível
Autoextinguible
Self extinguishing
Autoextinguible



Teste Fio Incandescente
Prueba Hilo Incandescente
Glow Wire Test
Test of Fil Incandescent



Fecho com parafuso a 3/4
Cierre por tornillos a 3/4
Closed by screws a 3/4
Ferme par des vis a 3/4



Boquilhas IP 66
Conos IP 66
Grommets IP 66
Gradin IP66



Compatível
Compatible



Entradas Marcadas
Entradas Marcadas
Pre-moulded knock-outs
Presse-étoupes



Knock Out
Knock Out
Knock Out
Knock Out



Para usar com Cabos
Para uso con Cables
To use with Cables
Utiliser avec de Câbles

next

FireResistant E90

Caixas Boxline XX
Cajas Boxline estancas XX
Fire resistant E90 Boxline XX
Boîtes Boxline Anti-Feu E90 XX

E90

500V

IK08

IP66



Tested
TO DIN 4102-12

NOVO SISTEMA

New System

Ease of Installation

New ceramic busbar installation solution with a raised chassis, which allows for better organization and routing of cables underneath the chassis.

Facilidade de Instalação

Nova solução de instalação de barras cerâmicas com chassi elevado, que permite uma melhor organização e arrumação dos cabos por baixo do chassi.

Nuevo Sistema

Facilidad de Instalación

Nueva solución de instalación de barras cerámicas con chasis elevado, que permite una mejor organización y disposición de los cables por debajo del chasis.

Nouveau Système

Facilité d'Installation

Nouvelle solution d'installation de barres en céramique avec châssis surélevé, permettant une meilleure organisation et disposition des câbles sous le châssis.



90 Min
de vantagem
contra fogo

advantage against fire
de ventaja contra el fuego
d'avance contre le feu

BORNES CERÂMICOS

CERAMIC TERMINALS | BORNES CERÁMICOS | BORNERS EN CÉRAMIQUE



4

Entradas de cabo por conector
Cable entries per terminal

Entradas de cable por borne
Entrées de câble par borne

6 mm²

Capacidade de Cabo (por polo): Rígido 0.8-6.0 mm²; Flexível 0.8-4.0 mm²
Cable Capacity (per pole): Solid 0.8-6.0 mm²; Flexible 0.8-4.0 mm²
Capacidad de Cable (por polo): Rígido 0.8-6.0 mm²; Flexible 0.8-4.0 mm²
Capacité de Câble (par pôle): Rigide 0.8-6.0 mm²; Flexible 0.8-4.0 mm²
Dim: 19 x 13 x 21.5 mm.

16 mm²

Capacidade de Cabo (por polo): Rígido 1.5-16.0 mm²; Flexível 1.5-10.0 mm²
Cable Capacity (per pole): Solid 1.5-16.0 mm²; Flexible 1.5-10.0 mm²
Capacidad de Cable (por polo): Rígido 1.5-16.0 mm²; Flexible 1.5-10.0 mm²
Capacité de Câble (par pôle): Rigide 1.5-16.0 mm²; Flexible 1.5-10.0 mm²
Dim: 25.5 x 19 x 25.5 mm

25 mm²

Capacidade de Cabo (por polo): Rígido 2.5-25.0 mm²; Flexível 2.5-16.0 mm²
Cable Capacity (per pole): Solid 2.5-25.0 mm²; Flexible 2.5-16.0 mm²
Capacidad de Cable (por polo): Rígido 2.5-25.0 mm²; Flexible 2.5-16.0 mm²
Capacité de Câble (par pôle): Rigide 2.5-25.0 mm²; Flexible 2.5-16.0 mm²
Dim: 32.4 x 32.4 x 25 mm



SCAN + INFO



Termoplástico
Termoplastico
Thermoplastic
Thermoplastique



-15°C
+45°C



Autoextinguível
Autoextinguible
Self extinguishing
Autoextinguible



Teste Fio Incandescente
Prueba Hilo Incandescente
Glow Wire Test
Test de Fil Incandescent



Fecho com parafuso a 3/4
Cierre por tornillos a 3/4
Closed by screws at 3/4
Ferme par des vis a 3/4



Boquilhas IP 66
Conos IP 66
Grommets IP 66
Gradin IP66



Compatível
Compatible



Entradas Marcadas
Entradas Marcadas
Pre-moulded knock-outs
Presse-étoupes



Knock Out
Knock Out
Knock Out
Knock Out



Para usar com Cabos
Para uso com Cables
To use with Cables
Utiliser avec de Câbles



Secção Min-Max (mm²)
Sección Min-Max (mm²)
Min-Max section (mm²)



Nº de entradas
Nº de agujeros
Nº of entries
Nº de connexions



SCAN + INFO



J100SF-N3P16

REFERÊNCIA PRODUTO
PRODUCT REFERENCE
REFERENCIA PRODUCTO
RÉFÉRENCE PRODUIT



J100

MODELO
MODEL
MODELO
MODÈLE



SF

TIPO
TYPE
TIPO
TYPE



N

GERAÇÃO
GENERATION
GENERACIÓN
GÉNÉRATION



3

BORNES
TERMINAL BLOCKS
BORNES
BORNES



P16

CAPACIDADE
CAPACITY
CAPACIDAD
CAPACITÉ

J100 | 116x116x62

Ref		Dim. Int (mm)	IP	IK	...			Min-Max mm ²	Ø
J100SF-N3P6	960°	116x116x62	66	08	3		7 x M20	0,8 - 6 mm ²	7-13
J100SF-N5P6	960°	116x116x62	66	08	5		7 x M20	0,8 - 6 mm ²	7-13
J100SF-N3P16	960°	116x116x62	66	08	3		7 x M20	1,5 - 16 mm ²	7-13
J100BF-N3P6	960°	116x116x62	66	08	3		7 x IP66	0,8 - 6 mm ²	3,5 - 25
J100BF-N5P6	960°	116x116x62	66	08	5		7 x IP66	0,8 - 6 mm ²	3,5 - 25
J100BF-N3P16	960°	116x116x62	66	08	3		7 x IP66	1,5 - 16 mm ²	3,5 - 25
J100MF-N3P6	960°	116x116x62	66	08	3		7 x M20/M25	0,8 - 6 mm ²	9 - 17,5
J100MF-N5P6	960°	116x116x62	66	08	5		7 x M20/M25	0,8 - 6 mm ²	9 - 17,5
J100MF-N3P16	960°	116x116x62	66	08	3		7 x M20/M25	1,5 - 16 mm ²	9 - 17,5

J160 | 166x116x72

Ref		Dim. Int (mm)	IP	IK	...			Min-Max mm ²	Ø
J160BF-N5P6	960°	166x116x72	66	08	5		10 x IP66	0,8 - 6 mm ²	3,5 - 25
J160BF-N5P16	960°	166x116x72	66	08	5		10 x IP66	1,5 - 16 mm ²	3,5 - 25
J160BF-N3P25	960°	166x116x72	66	08	3		10 x IP66	2,5 - 25 mm ²	3,5 - 25
J160MF-N5P6	960°	166x116x72	66	08	5		10 x M20/M25	0,8 - 6 mm ²	9 - 17,5
J160MF-N5P16	960°	166x116x72	66	08	5		10 x M20/M25	1,5 - 16 mm ²	9 - 17,5
J160MF-N3P25	960°	166x116x72	66	08	3		10 x M20/M25	2,5 - 25 mm ²	9 - 17,5

J200 | 216x166x92

Ref		Dim. Int (mm)	IP	IK	...			Min-Max mm ²	Ø
J200BF-N5P16	960°	216x166x92	66	08	5		10 x IP66	1,5 - 16 mm ²	3,5 - 32
J200BF-N3P25	960°	216x166x92	66	08	3		10 x IP66	2,5 - 25 mm ²	3,5 - 32
J200BF-N5P25	960°	216x166x92	66	08	5		10 x IP66	2,5 - 25 mm ²	3,5 - 32
J200MF-N5P16	960°	216x166x92	66	08	5		10 x M25/M32	1,5 - 16 mm ²	9 - 20,5
J200MF-N3P25	960°	216x166x92	66	08	3		10 x M25/M32	2,5 - 25 mm ²	9 - 20,5
J200MF-N5P25	960°	216x166x92	66	08	5		10 x M25/M32	2,5 - 25 mm ²	9 - 20,5
J200LF-N5P16	960°	216x166x92	66	08	5	-	-	1,5 - 16 mm ²	-
J200LF-N3P25	960°	216x166x92	66	08	3	-	-	2,5 - 25 mm ²	-
J200LF-N5P25	960°	216x166x92	66	08	5	-	-	2,5 - 25 mm ²	-

* Boquilhas incluídas | Conos incluidos | Stepped Rubber Grommet included | Embouts à gradin inclut
* Bucim não incluído | Prensaestopas no incluído | Cable glands not included | Presse-étoupes non inclut

Saiba mais
Documentação Técnica Detalhada

jsl-online.com/e90next-comercial



Learn more
Detailed Technical Documentation

Saber más
Documentación Técnica Detallada

En savoir plus
Documentation technique détaillée



NOVO
NEW

Caixas Boxline estanques antifogo E90 com entradas marcadas para partir
Cajas Boxline estancas Antifuego E90 con entradas marcadas para romper
Fire resistant E90 Boxline Cable junction enclosures with pre-moulded knock-outs
Boîtes Boxline Anti-Feu E90 de derivation étanches pour découper



Laranja
Naranja
Orange

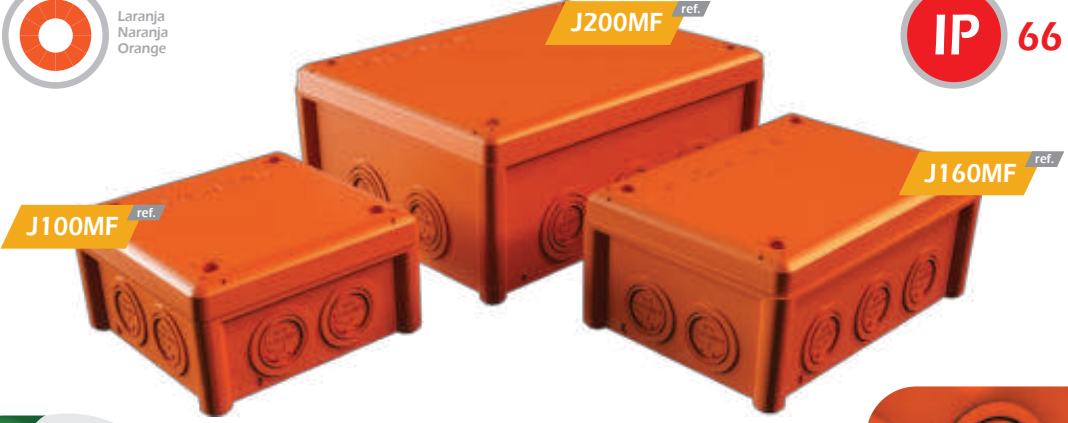

ABERTURA FÁCIL
Novo Desenho com
entradas marcadas
concêntricas

FÁCIL APERTURA
Nuevo diseño con
entradas marcadas
concêntricas

EASY OPENING
New design with
marked concentric
entries

OUVERTURE FACILE
Nouveau design avec
entrées concentriques
marquée

J100-M ref. J160-M ref.

ENTRADAS PARA
ACESSÓRIOS DIÂMETRO
PG13,5 / M20 / M25

ENTRADAS PARA
ACCESORIOS DIÂMETRO
PG13,5 / M20 / M25

INPUTS FOR ACCESSORIES
DIAMETER
PG13,5 / M20 / M25

ENTRÉES POUR
ACCESSOIRES
DIAMÈTRE
PG13,5 / M20 / M25



J200-M ref.

ENTRADAS PARA
ACESSÓRIOS DIÂMETRO
PG13,5 / M20 / M25 / M32

ENTRADAS PARA
ACCESORIOS DIÂMETRO
PG13,5 / M20 / M25 / M32

INPUTS FOR
ACCESSORIES DIAMETER
PG13,5 / M20 / M25 / M32

ENTRÉES POUR
ACCESSOIRES DIAMÈTRE
PG13,5 / M20 / M25 / M32

M25



M20



8-13

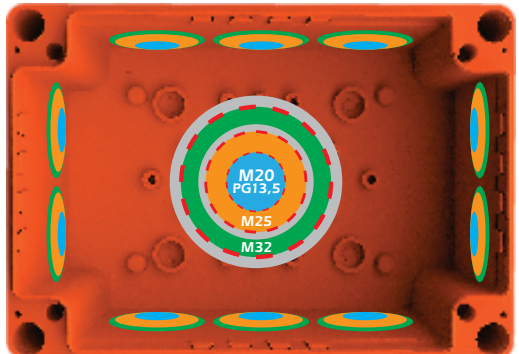
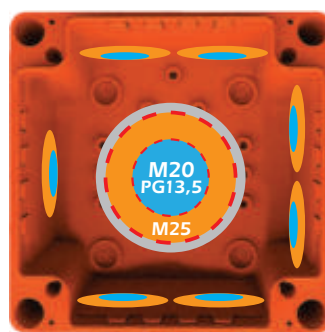

M32



16-20

- Termoplástico
Termoplastico
Thermoplastic
Thermoplastique
- 15°C
+45°C
- Autoextinguível
Autoextinguible
Self extinguishing
Autoextinguible
- Teste Fio incandescente
Prueba Hilo Incandescente
Glow Wire Test
Test of Fil Incandescent
- Fecho com parafuso a 3/4
Cierre por tornillos a 3/4
Closed by screws at 3/4
Ferme par des vis a 3/4
- Compatível
Compatible
- Entradas Marcadas
Entradas Marcadas
Pre-moulded knock-outs
Presse-étoupes
- Knock Out
Knock Out
Knock Out
Knock Out
- Para usar com Cabos
Para uso con Cables
To use with Cables
Utiliser avec de Câbles
- Secção Min-Max (mm²)
Sección Min-Max (mm²)
Min-Max section (mm²)
- Nº de entradas
Nº de agujeros
Nº of entries
Nº de connections



SCAN + INFO

Ref		Dim. Int (mm)	IP	IK			
J100MF	960°	102x102x55	66	08	7 x M20/M25	1,5-6	Variável - Variable
J160MF	960°	102 x 152 x 65	66	08	10 x M20/M25	1,5-10	Variável - Variable
J200MF	960°	152 x 202 x 85	66	08	10 x M32	1,5-16	Variável - Variable



Termoplástico
Termoplastico
Thermoplastic
Thermoplastique



-15°C
+45°C



Autoextinguível
Autoextinguible
Self extinguishing
Autoextinguible



Teste Fio incandescente
Prueba Hilo Incandescente
Glow Wire Test
Test de Fil Incandescent



3/4
Fecho com parafuso a 3/4
Cierre por tornillos a 3/4
Closed by screws at 3/4
Ferme par des vis a 3/4



Para usar com Cabos
Para uso con Cables
To use with Cables
Utiliser avec de Cables



Laranja
Naranja
Orange



Secção Min-Max [mm²]
Sección Min-Max [mm²]
Min-Max section [mm²]



Nº de entradas
Nº de agujeros
Nº of entries
Nº de connexiones



Boquilhas IP 66
Conos IP 66
Grommets IP 66
Gradin IP66



SCAN + INFO

Caixas estanques antifogo E90 | Cajas Antifuego estancas E90
Fire resistant Boxes E90 | Boites étanches Anti-Feu E90

E90
FIRE RESISTANT

J100BF ref.

J160BF ref.

J200BF ref.

J100SF ref.

Categoria E90 de acordo com DIN 4102-Part 12.
- IP 66, IK 08
- Montagem através de buchas de ancoragem em aço tratado para condições de fogo (Certificadas no Deutsches Institut für Bautechnik).

Categoria E90 según DIN 4102-Part 12.
- IP 66, IK 08
- Fijación por tacos de anclaje de acero tratado para situación de incendio (Certificados en el Deutsches Institut für Bautechnik).

Category E90 according DIN 4102-part 12.
- IP 66, IK 08
- Fixing by steel anchor dowels treated for fire conditions (Certified at Deutsches Institut für Bautechnik).

Catégorie E90 selon DIN 4102-Part 12.
- IP 66, IK 08
- Fixation par chevilles d'ancrage en acier traité pour des conditions d'incendie (Certifiées par le Deutsches Institut für Bautechnik).

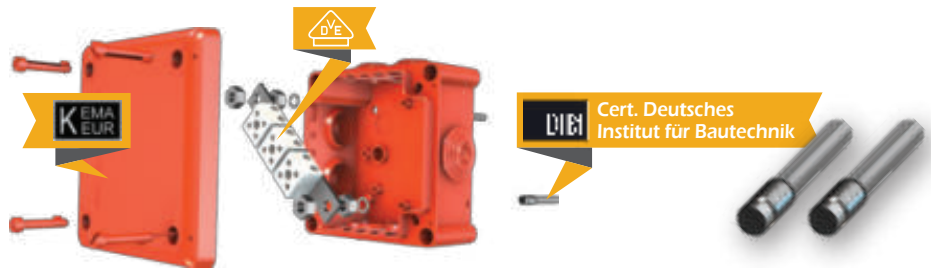

- Conectores de cerâmica em esteatite de elevada resistência a temperaturas de fornalha, certificados VDE.
- Isolamento classe II
- Caixas em material autoextinguível V0
- Certificadas KEMA KEUR de acordo com IEC EN 60670-22.
- Livres de halogéneos.

- Conectores cerâmicos de esteatita de alta resistencia a la temperatura de horno certificados VDE.
- Aislamiento Clase II.
- Cajas en material autoextinguible V0.
- Certificadas KEMA KEUR según la norma IEC EN 60670-22.
- Libres de halógenos.

- Steatite ceramic connectors resistant to furnace high temperature, VDE certified. Insulation Class II.
- Boxes molded in V0 selfextinguishing material. - Certified KEMA KEUR according to IEC EN 60670-22.
- Halogen-free.

- Connecteurs céramiques en stéatite pour hautes températures, certifiés VDE. - Isolation Classe II.
- Boîtes en matériel V0 auto-extinguible. - Certifiés KEMA KEUR selon la norme CEI EN 60670-22.
- Sans halogènes.

NOTA: As caixas poderão ser fornecidas com conectores cerâmicos de outras capacidades (a pedido).
Adequadas para cabos de: Tumka, Dätwyler, Eupen, Nexans, Pirelli, Leoni Studer, Prysmian e outros de acordo com DIN 4102 Part 12.

NOTA: Las cajas se pueden suministrar con conectores cerâmicos de otras capacidades (bajo demanda).
Adecuadas para cables: Tumka, Dätwyler, Eupen, Nexans, Pirelli, Studer Leoni, Prysmian y otros según DIN 4102 Parte 12.

NOTICE: The boxes can be supplied with ceramic connectors with other capacities (on demand).
Appropriate for cables: Tumka, Dätwyler, Eupen, Nexans, Pirelli, Leoni Studer, Prysmian and others according to DIN 4102 Part 12.

REMARQUE: Les boîtes peuvent être fournis avec des connecteurs en céramique d'autres capacités (sur demande).
Appropriées pour les câbles: Tumka, Dätwyler, Eupen, Nexans, Pirelli, Leoni Studer, Prysmian et les autres selon la norme DIN 4102 partie 12.

J100-SF MCP ref.

M20/V0 | M25/V0 ref.

Armadura metálica de protecção IK 10 para J100BF e J100SF
Armadura metálica de protección IK10 para J100BF y J100SF
Metallic armor protection IK10 for J100BF and J100SF
Armure métallique protection IK10 pour J100BF et J100SF



Bucins métricos
Prensaestopas metricas
Metric cable glands
Presse-étoupes métriques



Ref	🔗	Dim. Int (mm)	IP	IK	🔥	🔧	🔗	Min\varnothing->Max mm ²	🔗 Ø
J100SF	960°	102x102x55	66	08	🔥	🔧	7 x M20	1,5 - 6mm ²	8-13
J100BF	960°	102x102x55	66	08	🔥	🔧	7 x M25	1,5 - 6mm ²	3,5-25
J160BF	960°	102x152x65	66	08	🔥	🔧	10 x M25	1,5 - 10mm ²	3,5-25
J200BF	960°	152x202x85	66	08	🔥	🔧	10 x M32	1,5 - 16mm ²	3,5-32
J100SF-MCP	-	-	-	10	-	-	-	-	-

* Boquilhas incluídas | Conos incluídos | Stepped Rubber Grommet included | Embouts à gradin incluíd
* Bucin não incluído | Prensaestopas no incluído | Cable glands not included | Presse-étoupes non incluíd

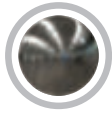

Aço
Acero
Steel
Acier



Cerâmica
Cerámica
Ceramics
Céramique



Para usar com Cabos
Para uso con Cables
To use with Cables
Utiliser avec de Câbles



Secção Min-Max (mm²)
Sección Min-Max (mm²)
Min-Max section (mm²)



E90

FIRE RESISTANT

Barras cerâmicas em Esteatite - Aperto por parafuso
Borneras ceramicas en estatita - Conexión por tornillo
Estateite ceramic connecting bars - Screw connection
Connecteur céramique en stéatite - Serrage à vis

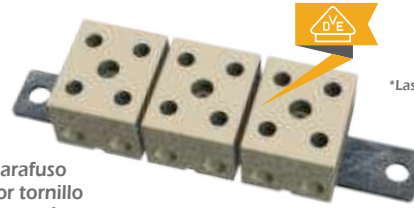

*Barras cerâmicas não vendidas em separado
*Las barras de cerámica no se venden por separado.
*Ceramic bars not sold separately
*Barres en céramique non vendues séparément



Barra conectora Bornera Bar connector Barre de connexion	Nº de vias Nº of poles Nº de vias Nº de pôles	V Nominal	Área de aperto Area de sujección Clamping area Capacité de serrage	A Nominal
6mm ²	2	450V	1,5 - 6,0 mm	24 A
10mm ²	2	450V	2,5 - 10,0 mm	32 A
16mm ²	2	450V	2,5 - 16,0 mm	54 A
33mm ²	2	450V	2,5 - 32,0 mm	100 A
55mm ²	2	450V	4,0 - 55,0 mm	130 A



Ref	Quantidade placas incluídas Standard per box - Standard par boîte	Min. Max de Barras Cerâmica p. Caixa
J100SF	6 mm ² 	x 3 Min. 1 - Max. 3
J100SF-P10	10 mm ² 	x 3 Min. 1 - Max. 3
J100SF-P16	16 mm ² 	x 2 Min. 1 - Max. 2
J100BF J100MF	6 mm ² 	x 3 Min. 1 - Max. 3
J100BF-P10 J100MF-P10	10 mm ² 	x 3 Min. 1 - Max. 3
J100BF-P16 J100MF-P16	16 mm ² 	x 2 Min. 1 - Max. 2
J160BF J160MF	10 mm ² 	x 3 Min. 1 - Max. 4
J160BF-P16 J160MF-P16	16 mm ² 	x 3 Min. 1 - Max. 3
J200BF J200MF	16 mm ² 	x 3 Min. 1 - Max. 4
J200BF-P33 J200MF-P33	33 mm ² 	x 3 Min. 1 - Max. 4
J200BF-P55 J200MF-P55	55 mm ² 	Por consulta By request Por consulta By request



SCAN + INFO

E90

FIRE RESISTANT

PARA CIRCUITOS RELACIONADOS COM A SEGURANÇA INTRÍNSECA DAS INSTALAÇÕES.

FOR CIRCUITS RELATED TO THE INTRINSIC SAFETY OF INSTALLATIONS.

ADEQUADAS PARA SUITABLE FOR



Resistente à chama
Flame resistant

- SALAS DE CONTROLO E COMANDO, HOSPITAIS, ESCOLAS
CONTROL AND COMMAND ROOMS, HOSPITALS, SCHOOLS
- INSTALAÇÕES ELÉCTRICAS E DE TELECOMUNICAÇÕES DE SOBREVIVÊNCIA
SURVIVAL ELECTRICAL AND TELECOMMUNICATIONS INSTALLATIONS
- LOCAIS DE MONTAGEM, GARAGENS, ZONAS SEGURANÇA E EVACUAÇÃO DE EMERGÊNCIA
ASSEMBLY LOCATIONS, GARAGES, SAFETY ZONES AND EMERGENCY EVACUATION
- ZONAS COM CARACTERÍSTICAS CORROSIVAS, TEMPERATURAS EXTREMAS, FORTES IMPACTOS
AREAS WITH CORROSIVE CHARACTERISTICS, EXTREME TEMPERATURES, STRONG IMPACTS
- ILUMINAÇÃO DE EMERGÊNCIA EM TÚNEIS E INSTALAÇÕES SUBTERRANEAS
FOR EMERGENCY LIGHTING IN TUNNELS AND UNDERGROUND INSTALLATIONS



VANTAGENS BENEFITS

IK
08

PROTECÇÃO CONTRA IMPACTOS MECÂNICOS
PROTECTION AGAINST MECHANICAL IMPACTS

IP
66

GRAU DE PROTECÇÃO
DEGREE OF PROTECTION

-15°C
+45°C

TEMPERATURA DE FUNCIONAMENTO
OPERATING TEMPERATURE

VO

AUTO-EXTINGUÍVEL
SELF EXTINGUISHABLE

LIVRE
HALÓGENEOS
WECARE

ISENTAS DE HALOGÉNEO
HALOGEN FREE



Visite o nosso website
em **jsl-online.com**

Visit our website
at **jsl-online.com**



Optimizado para mobile
para que encontre facilmente o que procura!

Optimized for mobile
so you can easily find what you are looking for!

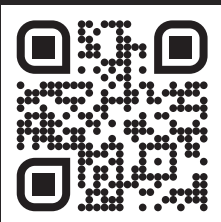

CAIXAS PARA INSTALAÇÃO INTERIOR

Cajas para instalación empotrada
Flush mounting boxes
Boîtes d'encastrement





Termoplástico
Termoplastico
Thermoplastic
Thermoplastique



-5°C
+60°C



Amarelo | Laranja
Amarillo | Naranja
Yellow | Orange
Jaune | Orange



Autoextinguível
Autoextinguible
Self extinguishing
Autoextinguible



Teste Fio incandescente
Prueba Hilo Incandescente
Glow Wire Test
Test de Fil Incandescent



Diametro de corte
Diámetro de corte
Cutting Diameter
Diamètre de coupe



Agrupável
Apilable
Stackable
Empilable



Para pladur
Para paredes huecas
For plaster walls
Pour cloisons sèches



RoHS



HF
HALOGEN FREE



REACH



SCAN + INFO

404

ref.

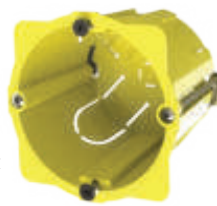

Caixa de aparelhagem agrupável
Caja para mecanismos enlazable
Flush mounted groupable switch box
Boîte pour appareillage jumelable



406

ref.



Caixa de aparelhagem agrupável
Caja para mecanismos enlazable
Flush mounted groupable switch box
Boîte pour appareillage jumelable



407

ref.



Caixa de aparelhagem agrupável
Caja para mecanismos enlazable
Flush mounted groupable switch box
Boîte pour appareillage jumelable



408

ref.



Caixa dupla agrupável
Caja double enlazable
Double Flush groupable box
Boîte double jumelable



424

ref.



Caixa de aparelhagem agrupável
Caja para mecanismos enlazable
Flush mounted groupable switch box
Boîte pour appareillage jumelable



426

ref.



Caixa de aparelhagem agrupável
Caja para mecanismos enlazable
Flush mounted groupable switch box
Boîte pour appareillage jumelable



428

ref.



Caixa dupla de apar. agrupável
Caja dupla para mecan. enlazable
Double Flush mount. group. box
Boîte double pour appar. jumelable



429

ref.



Caixa tripla de apar. agrupável
Caja tripla para mecan. enlazable
Triple Flush mount. groupable. box
Boîte triple pour appar. jumelable



409-U

ref.



Túnel p. condutores
Tunel paso de cables
Tunnel cable routing
Câble tunnel routage

409

ref.

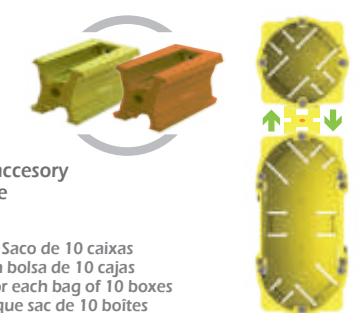

Peça de união
Accesorio de enlace
Grouping / Stackable accessory
Accessoire de jumelage

3 Peças de união por cada Saco de 10 caixas
3 Piezas de unión por cada bolsa de 10 cajas
3 Union pieces included for each bag of 10 boxes
3 Pièces d'union pour chaque sac de 10 boîtes



Termoplástico
Termoplastico
Thermoplastic
Thermoplastique



-5°C
+60°C



Amarelo
Amarillo
Yellow
Jaune



Autoextinguível
Autoextinguible
Self extinguishing
Autoextinguible



Teste Fio incandescente
Prueba Hilo Incandescente
Glow Wire Test
Test de Fil Incandescent



Diametro de corte
Diámetro de corte
Cutting Diameter
Diamètre de coupe



Recebe acessórios
Recibe accesorios
Receives accessories
Receus accessoires



Para pladur
Para paredes huecas
For plaster walls
Pour cloisons sèches



SCAN + INFO

405 ref.



Caixa de derivação c/ tampa
Caja derivación c/ tapa
Junction box with lid
Boîte dérivation avec couvercle



Recebe
Receives
Receus

Ref.
398/3
398/5



403 ref.



Caixa de aplique c/ tampa
Caja punto Luz c/ tapa
Lamp box with lid
Boîte point de centre avec couvercle



Todas as referências são:
Todas las referencias son:
All references are:
Toutes les références sont:



Para pladur
Para paredes huecas
For plaster walls
Pour cloisons sèches



Teste Fio incandescente
Prueba Hilo Incandescente
Glow Wire Test
Test de Fil Incandescent



Agrupável
Apilable
Stackable
Empilable

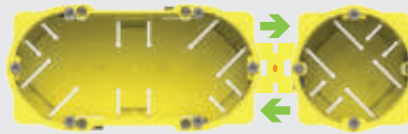

409 ref.



Acessório para agrupar
Accesorio de enlace
Grouping / Stackable accessory
Accessoire de jumelage

Ref	Dim. Ext(mm)	Glow /Incandes. Test	Auto Exting.	Temp.
404	65 x 50 mm	850°C	✓	-5+60
406	65 x 60 mm	850°C	✓	-5+60
407	65 x 40 mm	850°C	✓	-5+60
408	65 x 142 x 50 mm	850°C	✓	-5+60
409	-	850°C	✓	-5+60
424	68 x 45 mm	850°C	✓	-5+60
426	68 x 60 mm	850°C	✓	-5+60
428	68 x 142 x 45 mm	850°C	✓	-5+60
429	68 x 213 x 45 mm	850°C	✓	-5+60
409-U	-	850°C	✓	-5+60
405	110 x 110 x 40 mm	850°C	✓	-5+60
403	44 x 38 mm	850°C	✓	-5+60



Visite a nossa página para mais informações sobre esta gama certificados e/ou declarações de conformidade.
Visite nuestra página para obtener más información sobre esta gama de certificados y/o declaraciones de conformidad.
Visit our page for more information on this range, certificates and / or compliances documentation.
Visitez notre page pour savoir des autres informations telecharger des certificats et / ou déclarations de conformité



Termoplástico
Termoplastic
Thermoplastic
Thermoplastique



-5°C
+60°C



Cinza | Vermelho | Preto
Gris | Rojo | Negro
Gray | Red | Black
Gris | Rouge | Noir



Diametro de corte
Diámetro de corte
Cutting Diameter
Diamètre de coupe



Agrupável
Apilable
Stackable
Empilable



Nº de entradas
Nº de agujeros
Nº of entries
Nº de connections



Para Tijolo
Para Ladrillo
For brick
Pour Maçonnerie



RoHS



HF
HALOGEN FREE



REACH



319N ref.

Caixa de aparelhagem simples
Caja de mecanismos
Flush mounting box
Boîte d'appareillage

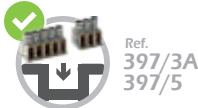

Ref. 397/3A
397/5



317N ref.

Caixa de aparelhagem funda
Caja de mecanismos
Flush mounting box
Boîte d'appareillage

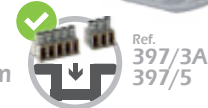

Ref. 397/3A
397/5



319-T ref.

Tampa para caixa de aparelhagem
Tapa para caja de mecanismos
Cover for Flush mounted switch box
Couvercle pour Boîte d'appareillage



Compatível com 317N - 319N | Compatible con 317N - 319N
Compatible with 317N - 319N | Compatible avec 317N - 319N



316 ref.

Cx. de aparelhagem
Caja de mecanismos
Flush mounting box
Boîte d'appareillage



318 ref. ited

Caixa de aparelhagem
Caja de mecanismos
Flush mounting box
Boîte d'appareillage



430 ref.

Caixa de aparelhagem (20 entradas)
Caja de mecanismos (20 entradas)
Flush mounting box (20 entries)
Boîte d'appareillage (20 entrées)



431 ref.

Caixa de aparelhagem (20 entradas)
Caja de mecanismos (20 entradas)
Flush mounting box (20 entries)
Boîte d'appareillage (20 entrées)



318 ref.



Concebida para receber aparelhagem de DOMOTICA e para Instalações ITED

Diseñada para recibir mecanismos y dispositivos de DOMOTICA

Designed to receive DOMOTIC appliances

Conçu pour utilisation avec les appareils de DOMOTIQUE

- Design práctico e multifuncional
- Simple and multifunctional design
- Design practico y multifuncional
- Design pratique et multifonctionnel

- Agrupável na horizontal e/ou vertical
- Grouped horizontal or vertically
- Enlazables en la horizontal o vertical
- Jumelables horizont. ou verticalement

- Entradas para tubos de 16, 20, 25
- Entries for 16, 20, 25 tubes
- Entradas para tubo de 16, 20, 25
- Entrées pour le tube 16, 20, 25



Concepção
Diseño
Design
Conception

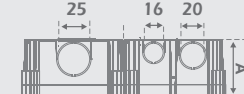

Ref	Dim. Ext(mm)	Recieve - Recebe	Ited - Domotic.	Temp.
319N	60 x 40 mm	397/3A - 397/5	✗	-5+60
317N	60 x 65 mm	397/3A - 397/5	✗	-5+60
319-T	-	-	✗	-5+60
316	75 x 75 x 42 mm	-	✓	-5+60
318	75 x 75 x 60 mm	-	✓	-5+60
430	70 x 70 x 50 mm	-	✗	-5+60
431	70 x 70 x 65 mm	-	✓	-5+60



SCAN + INFO



Termoplástico
Termoplastic
Thermoplastic
Thermoplastique



-5°C
+60°C



Preto
Negro
Black
Noir



Agrupável
Apilable
Stackable
Empilable



Recebe acessórios
Recibe accesorios
Receives accessories
Receus accessoires



Nº de entradas
Nº de agujeros
Nº of entries
Nº de connections



45 mm



Para Tijolo
Para Ladrillo
For brick
Pour Maçonnerie



RoHS



HALOGEN FREE



REACH



SCAN + INFO

315A-ST ref.

Caixa de derivação agrupável s/ tampa
Caja de derivación enlazable s/tapa
Junction box without lid /cover
Boîte dérivation jumelable sans couvercle

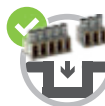

Ref.
397/3A
397/5



315A ref.

Caixa de derivação agrupável c/ tampa
Caja de derivación enlazable c/tapa
Junction box with lid /cover
Boîte dérivation jumelable avec couvercle

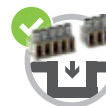

Ref.
397/3A
397/5



315A/2 ref.

Caixa de derivação dupla c/ tampa
Caja de derivación doble c/tapa
Double Junction box with lid /cover
Boîte dérivation double avec couvercle



Ref.
397/3A
397/5



315A/3 ref.

Caixa de derivação tripla c/ tampa
Caja de derivación triple c/tapa
Triple Junction box with lid /cover
Boîte dérivation triple avec couvercle



Ref.
397/3A
397/5

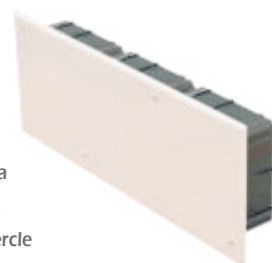

324A ref.

Tampa para caixa simples 315A-ST
Tapa para caja simple 315A-ST
Cover for simple box Junction 315A-ST
Couvercle pour Boîte 315A-ST



325A ref.

Tampa para caixa dupla 315A-ST
Tapa para caja doble 315A-ST
Cover for Junction double box 315A-ST
Couvercle pour Boîte double 315A-ST



326A ref.

Tampa para caixa tripla 315A-ST
Tapa para caja triple 315A-ST
Cover for Junction triple box 315A-ST
Couvercle pour Boîte triple 315A-ST

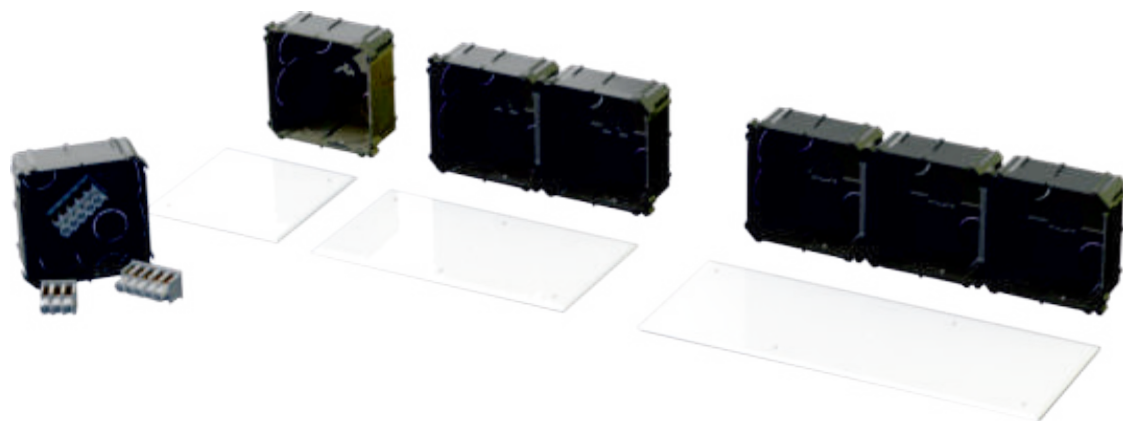

Ref	Dim. Ext[mm]	Recieve - Recebe	Temp.
315A-ST	100 x 100 x 45 mm	397/3A - 397/5	-5+60
315A	100 x 100 x 45 mm	397/3A - 397/5	-5+60
315A-2	200 x 100 x 45 mm	397/3A - 397/5	-5+60
315A-3	300 x 100 x 45 mm	397/3A - 397/5	-5+60
324-A	125 x 125 mm	-	-5+60
325-A	200 x 125 mm	-	-5+60
326-A	300 x 125 mm	-	-5+60



Termoplástico
Termoplastico
Thermoplastic
Thermoplastique



-5°C
+60°C



Cinza
Gris
Gray
Gris



Agrupável
Apilable
Stackable
Empilable



Recebe acessórios
Recibe accesorios
Receives accessories
Receus accessoires



Nº de entradas
Nº de agujeros
Nº of entries
Nº de connections



40
mm



Para Tijolo
Para Ladrillo
For brick
Pour Maçonnerie



RoHS



HALOGEN FREE



REACH



SCAN + INFO

315-ST ref.



Caixa de derivação agrupável s/ tampa
Caja de derivación enlazable s/tapa
Junction box without lid/cover
Boîte dérivation jumelable sans couvercle

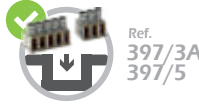

Ref.
397/3A
397/5

315 ref.



Caixa de derivação agrupável c/ tampa
Caja de derivación enlazable c/tapa
Junction box with lid/cover
Boîte dérivation jumelable avec couvercle

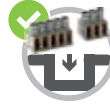

Ref.
397/3A
397/5

315/2 ref.



Caixa de derivação dupla c/ tampa
Caja de derivación doble c/tapa
Double Junction box with lid/cover
Boîte dérivation double avec couvercle

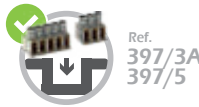

Ref.
397/3A
397/5

315/3 ref.



Caixa de derivação tripla c/ tampa
Caja de derivación triple c/tapa
Triple Junction box with lid/cover
Boîte dérivation triple avec couvercle



Ref.
397/3A
397/5

324 ref.



Tampa para caixa simples 315-ST
Tapa para caja simple 315-ST
Cover for simple box Junction 315-ST
Couvercle pour Boîte 315-ST

325 ref.



Tampa para caixa dupla 315-ST
Tapa para caja doble 315-ST
Cover for Junction double box 315-ST
Couvercle pour Boîte double 315-ST

326 ref.



Tampa para caixa tripla 315-ST
Tapa para caja triple 315-ST
Cover for Junction triple box 315-ST
Couvercle pour Boîte triple 315-ST

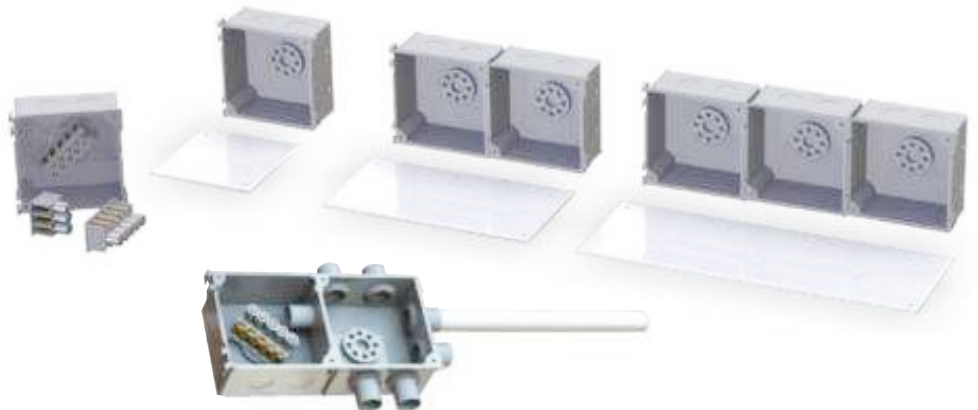

Ref	Dim. Ext(mm)	Recieve - Recebe	Temp.
315-ST	80 x 80 x 40 mm	397/3A - 397/5	-5+60
315	90 x 90 x 40 mm	397/3A - 397/5	-5+60
315-2	180 x 90 x 40 mm	397/3A - 397/5	-5+60
315-3	270 x 90 x 40 mm	397/3A - 397/5	-5+60
324	90 x 90 mm	-	-5+60
325	180 x 90 mm	-	-5+60
326	270 x 90 mm	-	-5+60



Termoplástico
Termoplastico
Thermoplastic
Thermoplastique



-5°C
+60°C



Cinza
Gris
Gray
Gris



Nº de entradas
Nº de agujeros
Nº of entries
Nº de connexiones



Diámetro de corte
Diámetro de corte
Cutting Diameter
Diamètre de coupe



Para Tijolo
Para Ladrillo
For brick
Pour Maçonnerie



RoHS



REACH



SCAN + INFO

400-ST ref.



Caixa de derivação s/ tampa
Caja de derivación s/tapa
Juntion box without lid/cover
Boîte dérivation sans couvercle



400 ref.



Caixa de derivação c/ tampa
Caja de derivación c/ tapa
Juntion box with lid / cover
Boîte dérivation avec couvercle



401 ref.

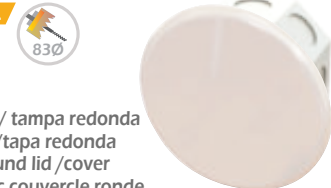

Caixa de derivação c/ tampa redonda
Caja de derivación c/tapa redonda
Juntion box with round lid /cover
Boîte dérivation avec couvercle ronde

400-T ref.



Tampa redonda para ref: 400-ST
Tapa redonda para ref: 400-ST
Round lid for ref: 400-ST
Couvercle ronde por ref: 400-ST

401-T ref.



Tampa quadrada para ref: 400-ST
Tapa quadrada para ref: 400-ST
Square lid for ref: 400-ST
Couvercle Carré por ref: 400-ST

402-ST ref.



Caixa de apliance sem tampa
Caja punto de luz sin tapa
Bracket Lamp Box without cover
Boîte applique sans couvercle

501001 ref.



Tampa univ. para ref: 404/406/407/424/426
Tapa universal para ref: 404/406/407/424/426
Universal lid for ref: 404/406/407/424/426
Couvercle universal por les ref: 404/406/407/424/426

402-T ref.



Tampa para Caixa de apliance
Tapa para Caja punto de luz
Cover for Bracket Lamp Box
Couvercle por Boîte applique

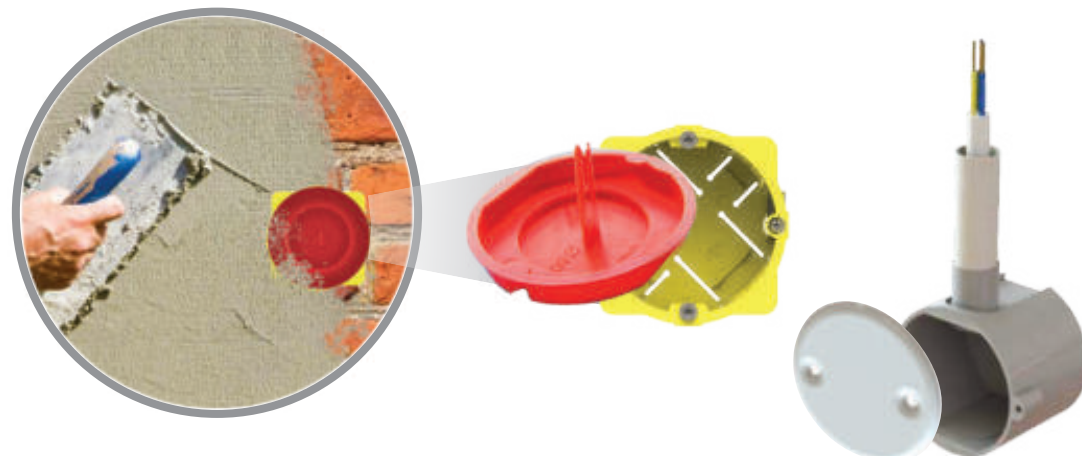

Ref	Dim. Ext(mm)	Recieve - Recebe	Temp.
400-ST	Ø 83 x 40 mm	-	-5+60
400	Ø 83 x 40 mm	-	-5+60
401	Ø 83 x 40 mm	-	-5+60
400-T	Ø 90	-	-5+60
401-T	90 x 90 mm	-	-5+60
402-ST	Ø 40 x 34 mm	-	-5+60
402-T	Ø 42	-	-5+60



Termoplástico
Termoplastico
Thermoplastic
Thermoplastique



-5°C
+60°C



Branco
Blanco
White
Blanch



Nº de entradas
Nº de agujeros
Nº of entries
Nº de connections



Entradas marcadas
Entradas marcadas
Premarked Entries
Entrées pré-déconpées



Para Tijolo
Para Ladrilho
For brick
Pour Maçonnerie

11 ref.

Caixas de Embeber para
Telecomunicações (Tipo Rita)

Cajas empotradas para
Telecomunicaciones

Flush Mounting
Boxes for Telecom

Boîtes d'Encastrement
pour Telecom



12 ref.

Caixas de Embeber para
Telecomunicações (Tipo Rita)

Cajas empotradas para
Telecomunicaciones

Flush Mounting
Boxes for Telecom

Boîtes d'Encastrement
pour Telecom



13 ref.

Caixas de Embeber para
Telecomunicações (Tipo Rita)

Cajas empotradas para
Telecomunicaciones

Flush Mounting
Boxes for Telecom

Boîtes d'Encastrement
pour Telecom



Todas as referências têm:
Todas las referencias tienen:
All references have:
Toutes les références ont:

Entradas marcadas para Tubo Ø20, Ø25 e Ø32
Entradas marcadas para Tubo Ø20, Ø25 y Ø32
Entries for Conduit Ø20, Ø25 and Ø32
Entrées pré-déconpées pour Conduit Ø20, Ø25 et Ø32



Teste Fio Incandescente
Prueba Hilo Incandescente
Glow Wire Test
Test de Fil Incandescent

650°C

Ref	Dim. Ext(mm)	Desc.		Temp.
11	62 x 50 mm	Caixas de Embeber p. Telecom (Tipo Rita)	6	-5+60
12	90 x 90 x 50 mm	Cajas empotradas para Telecom Flush Mounting Boxes for Telecom	8	-5+60
13	180 x 90 x 50 mm	Boîtes d'Encastrement pour Telecom	10	-5+60



Para Betão
Para Hormigon
For Concrete
Pour Béton

811 ref.

Caixas para aparelhagem
Cajas para mecanismos
Switch Box
Boîtes pour Appareillage



-15°C
+90°C



812 ref.

Tampa "Diafragma"
Tapa "Diafragma"
Lid "Diaphragm"
Couerle "Diaphragme"



-15°C
+90°C



813 ref.

Tampa Mergulhavel
Tapa Submergible
Sinkable Lid
Couvercle Submersible



-15°C
+90°C

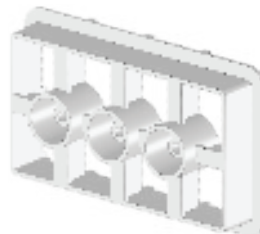

814 ref.

Manga para caixa de passagem
Manga para hacer caja de pasaje
Juntion to make a junction box
Joint pour faire un boîte de dist.



-15°C
+90°C



Ref	Dim. Ext(mm)	Desc.	Temp.
811	75 x 60 x 62 mm	Sistema para Betão Sistema dempotrar para Hormigon Concrete Formworks Systems Systeme d'encastrement pour Beton	-5+90
812	25 x 16 x 75 mm		-5+90
813	60 x 103 x 22,5 mm		-5+90
814	55 x 88 x 81 mm		-5+90





Termoplástico
Termoplastico
Thermoplastic
Thermoplastique



-15°C
+90°C



Branco
Blanco
White
Blanch



Para Betão
Para Hormigon
For Concrete
Pour Béton



Ref. 801

841 ref.

Caixas de derivação
Caja de derivación
Junction box
Boîte pour dérivation



842 ref.

Tampa estanque
Tapa estanca
Waterproof lid
Couvercle étanche



843 ref.

Tampa de acabamento
Tapa de acabado
Finishing lid
Couvercle de finition

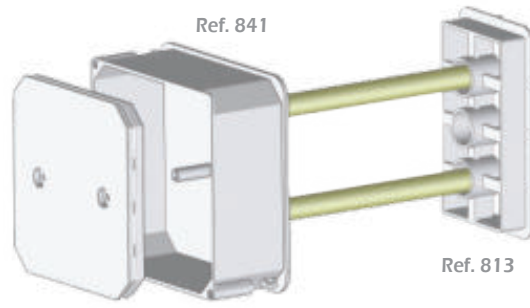

Ref. 841

Ref. 842

Ref. 813

Ref	Dim. Ext(mm)	Desc.	Temp.
841	105 x 105 x 56 mm	Caixas de Embeber para Betão	-5+60
842	95 x 95 x 10 mm	Cajas empotradas para hormigon	-5+60
843	111 x 111 mm	Flush Mounting Boxes for concrete	-5+60
		Boîtes d'Encastement pour Béton	-5+60



801 ref.

Caixas tecto tipo "Pagode"
Caja techo tipo "Pagode"
Ceiling box
Boîte pour plafond



802 ref.

Tampa estanque
Tapa estanca
Finishing Lid
Couvercle de finition



803 ref.

Tampa de acabamento
Tapa de acabado
Finishing Lid
Couvercle de finition



804 ref.

Suspensão para caixa
Suspension para caja
Ceiling hooks for box
Suspension du plafond pour boîte



Ref	Dim. Ext(mm)	Desc.	Temp.
801	91 x 100 mm	Sistema para Betão	-15+90
802	75 x 11 mm	Sistema dempotrar para Hormigon	-15+90
803	11 x 10,5 mm	Concrete Formworks Systems	-15+90
804	83 x 70 x 15 mm	Systeme d'encastrement pour Beton	-15+90



SCAN + INFO



Termoplástico
Termoplastico
Thermoplastic
Thermoplastique



-15°C
+60°C



Branco
Blanco
White
Blanch



Para Betão
Para Hormigon
For Concrete
Pour Béton



SCAN + INFO

831 ref.

Caixas de reserva
Caja de reserva
Accumulation box
Boîte de descendent
rectangulaire



832 ref.

Tampa estanque
Tapa estanca
Waterproof lid
Couvercle étanche



821 ref.

Caixa de aplique
Caja Punto de luz
Lamp fixing Box
Boîte point de centre



822 ref.

Tampa estanque
Tapa estanca
Waterproof lid
Couvercle étanche



823 ref.

Tampa de acabamento
Tapa de acabado
Finishing lid
Couvercle de finition



831 ref.

+ 832 ref.

841 ref.

+ 842 ref.

801 ref.

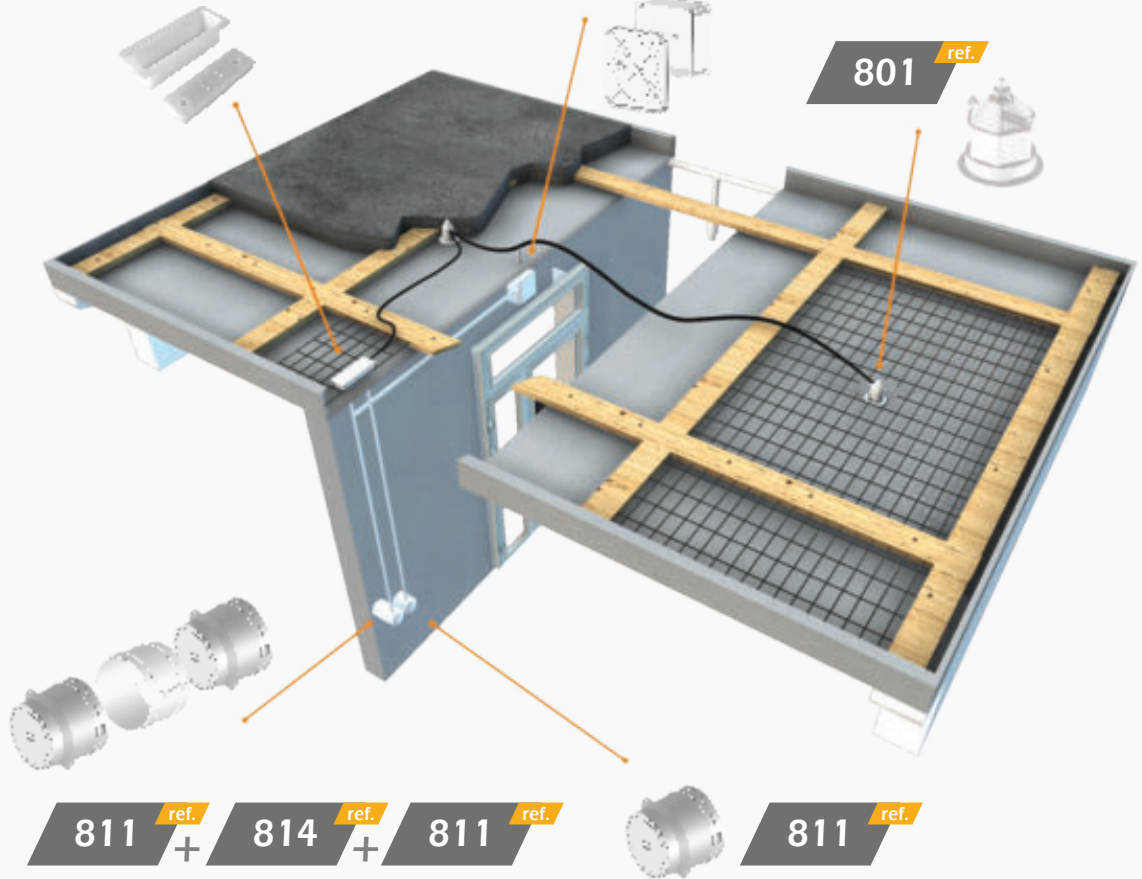

811 ref.

+ 814 ref.

+ 811 ref.

811 ref.

Ref	Dim. Ext(mm)	Desc.	Temp.
831	138 x 43 x 40 mm	Sistema para Betão Sistema dempotrar para Hormigon Concrete Formworks Systems Systeme d'encastrement pour Beton	-15+90
832	135 x 45 x 11 mm		-15+90
821	75 x 60 mm		-15+90
822	61,5 x 15 mm		-15+90
823	73,5 x 11,5 mm		-15+90
811			-15+90

QUADROS DE DISTRIBUIÇÃO

Cuadros de Distribución
Distribution boards
Coffrets de distribution



NORMAS
NORMES
COMPLIANCES

IEC 60439
EN 50298
EN 60439-3
EN 62208
EN 60529
EN 62262



Quadros de distribuição de embeber | Cuadros de distribución de empotrar
 Flush mounted MCB's distribution boards | Coffrets de distribution à encastrer



Termoplástico
 Termoplastico
 Thermoplastic
 Thermoplastique



-5°C
 +40°C



Branco
 Blanco
 White
 Blanche



Classe de isol. 2
 Clase de aisl. 2
 Insul. degree 2
 Class d' isolation 2



Profundidade
 Profundidad
 Depth
 Profondeur



Nivelamento ajustável
 Nivelamento ajustable
 Adaptable leveling
 Nivellement adaptable



Ajust. em profundidade
 Ajust. en profundidad
 Adjust. in depth
 Régl. en profondeur



Calha DIN
 Carril DIN
 DIN Rail
 Rail DIN



Mód. de disjuntor
 Mód. magnetotérmicos
 Mod. MCB
 Mod. disjoncteurs



Seláveis
 Precintable
 Can be sealed
 Scellage



SCAN + INFO



Versão Pré-instalação = V200 ref. + K200 ref.
 Versión de preinstalación
 Pre-installation version
 Version pré-installation

Quadro de distribuição de embeber até 26 módulos
 Cuadros de distribución de empotrar hasta 26 módulos
 Flush mounted MCB's distribution board up to 26 modules
 Coffrets de distribution à encastrer jusqu'à 26 modules

A200/2 Barramentos terra e neutro incluídos
 Bornas tierra e neutro incluídos
 A200/4 Terminal blocks earth and neutral are included
 Bornier Pour Terre et Neutre inclus



Versão Pré-instalação = V300 ref. + K300 ref.
 Versión de preinstalación
 Pre-installation version
 Version pré-installation

Quadro de distribuição de embeber até 24 módulos
 Cuadros de distribución de empotrar hasta 24 módulos
 Flush mounted MCB's distribution board up to 24 modules
 Coffrets de distribution à encastrer jusqu'à 24 modules

A300/2 Barramentos terra e neutro incluídos
 Bornas tierra e neutro incluídos
 A300/4 Terminal blocks earth and neutral are included
 Bornier Pour Terre et Neutre inclus

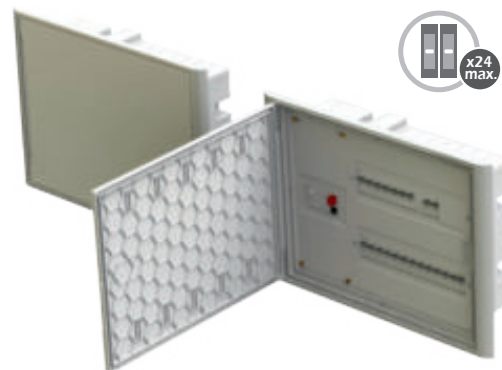

Versão Pré-instalação = V400 ref. + K400 ref.
 Versión de preinstalación
 Pre-installation version
 Version pré-installation

Quadro de distribuição de embeber até 40 módulos
 Cuadros de distribución de empotrar hasta 40 módulos
 Flush mounted MCB's distribution board up to 40 modules
 Coffrets de distribution à encastrer jusqu'à 40 modules

A400/2 Barramentos terra e neutro incluídos
 Bornas tierra e neutro incluídos
 A400/4 Terminal blocks earth and neutral are included
 Bornier Pour Terre et Neutre inclus



Seláveis
 Precintable
 Can be sealed
 Scellage

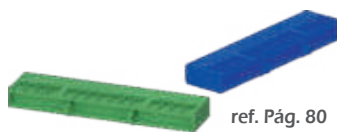

Ref.	Dim.(mm)	Amp.	Volt.	IP	IK	Nº MCB Disj.	
A200	504 X 360 X 126 mm	63	415	41	07	1 - 26	-
A200/2	504 X 360 X 126 mm	63	415	41	07	1 - 26	1+1
A200/4	504 X 360 X 126 mm	63	415	41	07	1 - 26	2+2
A300	504 X 360 X 94 mm	63	415	41	07	1 - 24	-
A300/2	504 X 360 X 94 mm	63	415	41	07	1 - 24	1+1
A300/4	504 X 360 X 94 mm	63	415	41	07	1 - 24	2+2
A400	509 X 480 X 94 mm	63	415	41	07	1 - 40	-
A400/2	509 X 480 X 94 mm	63	415	41	07	1 - 40	1+1
A400/4	509 X 480 X 94 mm	63	415	41	07	1 - 40	2+2

Quadros estanques e caixas ICT | Cajas para ICP estancas y cajas ICT
WaterProof boards and ICT enclosures | Coffrets étanches et boîtes ICT



Termoplástico
Termoplastico
Thermoplastic
Thermoplastique



-5°C
+60°C



Branco | Cinza
Blanco | Gris
White | Grey
Blanche | Gris



Classe de isol. 2
Clase de aisl. 2
Insul. degree 2
Class d'isolation 2



Protecção anti-UV
Protección contra-UV
Anti-UV protection
Protection contre-UV



Seláveis
Precintable
Can be sealed
Scellage



Chave
Llave
Key
Clé



Calha DIN
Carril DIN
DIN Rail
Rail DIN



Mód. de disjuntor
Mód. magnetotérmicos
Mod. MCB
Mod. disjoncteurs

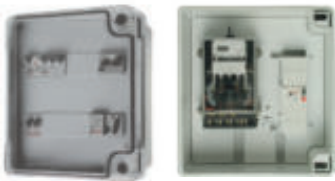

SCAN + INFO

MF-242 ref.

MF-244 ref.

Caixa de distribuição com porta, Fechadura e Chave
Caja de distribución con puerta, Cerradura y Clave
Distribution Enclosure with blank Door, Safety Lock and Key
Coffrets de distribution lisse avec porte, serrure et clé



Caixas certificada
Cajas certificada
Certified Enclosures
Coffrets Certifier



MF-242TR ref.

MF-244TR ref.

Caixa de distribuição com porta transparente, Fechadura e Chave
Caja de distribución con puerta transparente, Cerradura y Clave
Distribution Enclosure with transparent Door, Safety Lock and Key
Coffrets de distribution avec porte transparent, serrure et clé



MF-242TRP ref.

MF-244TRP ref.

Caixa de distribuição com porta policarbonato, Fechadura e Chave
Caja de distribución con puerta policarbonato, Cerradura y Clave
Distribution Enclosure with polycarbonat Door, Safety Lock and Key
Coffrets de distribution avec porte policarbonat, serrure et clé



Policarbonato

292MF ref.

Fechadura e chave
Cerradura y Clave
Lock and key
Serrure et clé



Todas as referências incluem,
Fechadura com respectiva Chave
Todas las referencias incluyen,
Cerradura con su clave
All references include,
Lock with respective Key
Toutes les références incluent,
Lock avec la clé respective



Seláveis
Precintable
Can be sealed
Scellage



Ref.	Dim.ext(mm)	Dim.int(mm)		IP	IK
MF-242	330 x 280 x 195	322 x 275 x 185	✓	65	09
MF-244	430 x 390 x 195	422 x 380 x 185	✓	54	09
MF-242TR	330 x 280 x 195	322 x 275 x 185	✓	65	05
MF-244TR	430 x 390 x 195	422 x 380 x 185	✓	54	05
MF-242TRP	330 x 280 x 195	322 x 275 x 185	✓	65	10
MF-244TRP	430 x 390 x 195	422 x 380 x 185	✓	54	10

Quadros de distribuição completos estanques e caixas ICT | Cajas completas para ICP y distribución estancas y cajas ICT
 Complete Waterproof distribution boards and ICT enclosures | Coffrets complète de distribution étanches et boîtes ICT

242TRC ref.

Quadro de distribuição completo estanque até 24 módulos.
 Caja de distribución completa estanco hasta 24 módulos.
 Complete Waterproof Distribution Boxes up to 24 modules.
 Coffrets de distribution complète étanche jusqu'à 24 modules.



242 TR Complet.

Inclui | Includi | Includes | Contient



244TRC ref.

Quadro de distribuição completo estanque até 54 módulos.
 Caja de distribución completa estanco hasta 54 módulos.
 Complete Waterproof Distribution Boxes up to 54 modules.
 Coffrets de distribution complète étanche jusqu'à 54 modules.



244TR Complet.

Inclui | Includi | Includes | Contient



Accessories for Waterproof distribution boards KITS and ICT enclosures | Accesorios para Cajas para ICP y distribución estancas
 Accessories for WaterProof distribution boards KITS and ICT enclosures | Accessoires pour les Coffrets de distribution étanches et boîtes ICT

242CL ref.

244CL ref.



Placa termoplástica Lisa
 Placa termoplástica lisa
 Blank thermoplastic plate
 Platine thermoplast. non percée



271MF ref.

Tampa cobre Módulos
 Tapa Cubre Módulos
 Blank cover for MCB's
 Couverture por MCB's



Branco e Cinza
 Blanco y Gris
 White and Grey
 Blanche et Gris

Compatível com todas as refs.de Quadros JSL com a excepção das refs 250
 Compatible con todas las refs.de Cuadros JSL con la excepción de refs 250
 Compatible with all the references of JSL boards with the exception of 250
 Compatible avec toutes les refs. des coffrets JSL à l'exception des refs 250

242QD ref.

244QD ref.



Quadro de Distribuição p/ ap. modulares
 Cuadro de Distribución p/ ap. modulares
 Panel w/window for Distribution Board
 Cadre pour Coffrets de distribution



273MF ref.

X12

12 seções modulares
 12 secciones modulares
 12 sections modulares
 12 sections modulares

Tampa cobre-módulos universal para todo tipo de quadros
 Tapa cobre módulos universal para todo tipo de cuadros
 Universal blank cover for MCB's
 Couverture universelle pour disjoncteurs

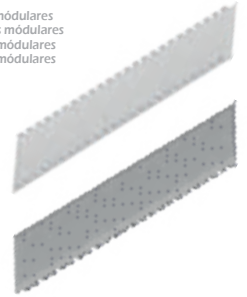

270MF ref.

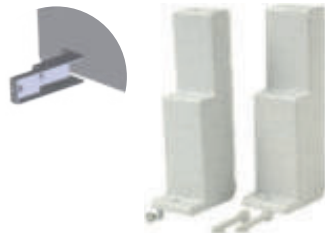
Par
Par
Pair
PairCinza
Gris
Grey
Gris

Suporte de Fixação para Quadro (par)
 Soporte de Fijación para Cuadro de Distribución (par)
 Fixing Support for Distribution Board (pair)
 Support de Fixation pour Cadre de Distribution (pair)



208MF ref.



Z - 208 mm

239MF ref.



Z - 239 mm

314MF ref.



Z - 314 mm

344MF ref.



Z - 344 mm

Rail DIN EN 50022
 Rail DIN EN 50022
 DIN EN 50022 Rail
 Calha DIN EN 50022

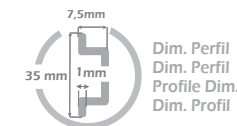

290MF ref.

291MF ref.

292MF ref.



Niquelado
 Niquelado
 Nickel plated
 Plaqué nickel

Fechadura em Nylon c/ Chave
 Cerradura en Nylon y c/ Clave
 Nylon lock w/Key
 Serrure en Nylon et clé

Chave triangular normalizada
 Clave triangular normalizada
 Standard triangular Key
 Clé triangulaire Standard

Fechadura metálica de seg. c/Chave
 Cerradura de metal de seg. c/Clave
 Safety metal lock w/Key
 Clé de sécurité en metal

293MF ref.



Ø 25

Par
Par
Pair
PairBranco e Cinza
Blanco y Gris
White and Grey
Blanche et Gris

Ventilador (par)
 Ventilador (par)
 Ventilator (pair)
 Ventilateur (pair)



Quadros de distribuição estanques e caixas ICT | Cuadros para ICP y distribución estancas y cajas ICT
WaterProof distribution boards and ICT enclosures | Coffrets de distribution étanches et boîtes ICT



Termoplástico
Termoplastico
Thermoplastic
Thermoplastique



-5°C
+40°C



Branco | Cinza
White | Grey
Blanche | Gris



55



08



Classe de isol. 2
Clase de aisl. 2
Insul. degree 2
Class d'isolation 2



Protecção anti-UV
Protección contra-UV
Anti-UV protection
Protection contre-UV



Seláveis
Precintable
Can be sealed
Scellage



Calha DIN
Carril DIN
DIN Rail
Rail DIN



Mód. de disjuntor
Mód. magnetotérmicos
Mod. MCB
Mod. disjoncteurs



RoHS



HF
HALOGEN FREE



REACH



CE



Seláveis
Precintable
Can be sealed
Scellage



Não Incluído
No Included
Not included
Non Inclus

250-5B ref.

250-9B ref.

250-11B ref.

Quadros de distribuição estanques com boquilhas
Cuadros de distribución estancos con conos
Waterproof dist. boards with stepped rubber grommets
Coffrets de distribution étanches avec embouts à gradin

Para uso de boquilhas
Para uso de conos
For stepped rubber grommets
Pour avec embouts à gradin



Pág.63
PG



250-5L ref.

250-9L ref.

250-11L ref.

Quadros de distribuição estanques com paredes lisas
Cuadros de distribución estancos con paredes lisas
Waterproof distribution boards with plain walls
Coffrets de distribution étanches non percées

250-5A ref.

250-9A ref.

250-11A ref.

Quadros de distri. estanques com entradas marcadas
Cuadros de distri. estancos con entradas marcadas
Waterproof distri. boards with pre-moulded knock-outs
Coffrets de distri. étanches avec des entrées pré-marquées

Para uso de buçins PG
Para uso de prensaestopas PG
For cable glands PG
Pour presse-étoupes PG



Pág.62
PG



250-5AM ref.

250-9AM ref.

250-11AM ref.

Quadros de distri. estanques com entradas marcadas
Cuadros de distri. estancos con entradas marcadas
Waterproof distri. boards with pre-moulded knock-outs
Coffrets de distri. étanches avec des entrées pré-marquées

Uso de buçins métricos
Uso de prensaestopas métricas
For metric cable glands
Pour presse-étoupes métriques



Pág.62
METRIC



Ref.					Y-X-Z Dim.(mm)	IP	IK
250-5B	4+1	10xPG21	-	-	162 x 122 x 95	55	08
250-9B	8+1	10xPG21	-	-	162 x 202 x 98	55	08
250-11B	10+1	10xPG29	-	-	182 x 232 x 109	55	08
250-5L	4+1	-	-	-	162 x 122 x 95	55	08
250-9L	8+1	-	-	-	162 x 202 x 98	55	08
250-11L	10+1	-	-	-	182 x 232 x 109	55	08
250-5A	4+1	-	10xPG16	-	162 x 122 x 95	55	08
250-9A	8+1	-	10xPG16	-	162 x 202 x 98	55	08
250-11A	10+1	-	10xPG16	-	182 x 232 x 109	55	08
250-5AM	4+1	-	-	6xM20 + 4xM25	162 x 122 x 95	55	08
250-9AM	8+1	-	-	6xM20 + 4xM25	162 x 202 x 98	55	08
250-11AM	10+1	-	-	8xM25+2xM32	182 x 232 x 109	55	08

Repartidores modulares protegidos | Repartidores modulares protegidos

Two and four - pole equipotential terminal blocks | Répartiteurs modulaires bipolaires et tetrapolaires



Termoplástico
Termoplastico
Thermoplastic
Thermoplastique



-5°C
+60°C

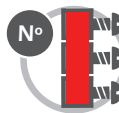

Nº de Entradas Barramentos
Nº de Entradas Bornas
Nº of Bus Bar
Nº entrées Bornieres



Nº Entradas Barramento
Nº Entradas bornera
N. Bus Bar Spec.
N. Entradas Barramento



Condutores (Secção mm2)
Condutores (seccion mm2)
Wires (section mm2)
Conducteurs (section mm2)

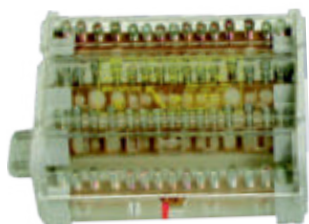
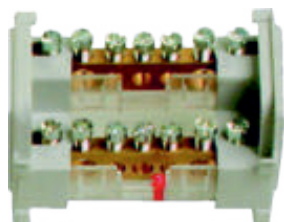

RoHS



REACH



SCAN + INFO

BIPOLARS | TWO POLES | BIPOLAIRES

6372BD ref. 10072BD ref. 125112BD ref. 125152BD ref.



TETRAPOLARS | FOUR POLES | TETRAPOLAIRES

6374BD ref. 10074BD ref. 125114BD ref.
125154BD ref. 160134BD ref.

Aceita condutores terminados com ou sem ponteiras. Fornecida com base de fixação posterior e tampa de protecção frontal transparente.
Material autoextinguível
Métodos de fixação: Fixação directa em calha DIN35 / Fixação em placa com 2 parafusos
Cada barramento possui isolamento de protecção. Poderá levar etiqueta
De acordo com normas EN60998-1 e EN60998-2, ICC: 20Ka em pic

Accepta conductores terminados em ponteras. Se suministra con base de montaje posterior y cubierta de protección frontal transparente.
Material autoextinguible
Métodos de fijación: Montaje directo en carril DIN35 / Montaje en placa con 2 tornillos
Cada bornera tiene un aislamiento protector y puede llevar una etiqueta
Según las normas EN60998-1 y EN60998-2, ICC: 20Ka en max.

Connection with or without ferrules. Supplied with insulated back plate and transparent protective front cover. Self-extinguishing material.
Mounting Methods: Fix on DIN-Rail / On plate with 2 screws
Insulation protection each bar. Each bar can be relabelled.
Conform to standard EN60998-1 and EN60998-2, ICC: 20Ka peak

Accepte les conducteurs finis ou avec des terminales. Livré avec une base de montage arrière et un couvercle de protection avant transparent.
Matériel autoextinguible
Méthodes de fixation : Montage direct sur rail DIN35 / Montage sur plaque avec 2 vis
Chaque bornier est dotée d'une isolation de protection et peut porter un label
Selon les normes EN60998-1 et EN60998-2, CPI : 20Ka pic

BIPOLARS | TWO POLES | BIPOLAIRES

Ref.	Amp.	Volt.	I _{pk} a	U _{imp} kV	Qt. Bar.	Entr.	Condutores terminados		Dim.(mm)
							COM ponteiras (Secção mm ²)	SEM ponteiras (Secção mm ²)	
6372BD	63	500	20	8	2	5 x Ø 5,3 mm 2 x Ø 7,5 mm	1,5 - 6 6 - 16	2,5 - 6 10 - 25	65x42x50
10072BD	100	500	20	8	2	5 x Ø 5,3 mm 2 x Ø 7,5 mm	1,5 - 6 6 - 16	2,5 - 6 10 - 25	65x42x50
125112BD	125	500	22	8	2	7 x Ø 5,3 mm 2 x Ø 7,5 mm 2 x Ø 9 mm	1,5 - 6 6 - 16 10 - 16	2,5 - 6 10 - 25 10 - 35	100x42x50
125152BD	125	500	22	8	2	11 x Ø 5,3 mm 2 x Ø 7,5 mm 2 x Ø 9 mm	1,5 - 6 6 - 16 10 - 16	2,5 - 6 10 - 25 10 - 35	135x42x50

TETRAPOLARS | FOUR POLES | TETRAPOLAIRES

Ref.	Amp.	Volt.	I _{pk} a	U _{imp} kV	Qt. Bar.	Entr.	Condutores terminados		Dim.(mm)
							COM ponteiras (Secção mm ²)	SEM ponteiras (Secção mm ²)	
6374BD	63	500	20	8	4	5 x Ø 5,3 mm 2 x Ø 7,5 mm	1,5 - 6 6 - 16	2,5 - 6 10 - 25	65x85x50
10074BD	100	500	20	8	4	5 x Ø 5,3 mm 2 x Ø 7,5 mm	1,5 - 6 6 - 16	2,5 - 6 10 - 25	65x85x50
125114BD	125	500	22	8	4	7 x Ø 5,3 mm 2 x Ø 7,5 mm 2 x Ø 9 mm	1,5 - 6 6 - 16 10 - 16	2,5 - 6 10 - 25 10 - 35	100x85x50
125154BD	125	500	22	8	4	11 x Ø 5,3 mm 2 x Ø 7,5 mm 2 x Ø 9 mm	1,5 - 6 6 - 16 10 - 16	2,5 - 6 10 - 25 10 - 35	135x85x50
160134BD	160	500	24	8	4	8 x Ø 7 mm 2 x Ø 8 mm 2 x Ø 9 mm 1 x Ø 12 mm	1,5 - 6 6 - 16 10 - 16 16 - 80	2,5 - 6 10 - 25 10 - 35 16 - 120	135x85x50

Ligadores suplementares | Bornas suplementares

Single - Pole equipotential Terminal blocks | Borniers de répartition



Termoplástico
Termoplastico
Thermoplastic
Thermoplastique



-5°C
+60°C



Azul | Verde
Azul | Verde
Blue | Green
Bleau | Vert



Furos disp. por ligador
Agujeros disp. por borna
Holes avail. in terminals
Bornes disp. par barres

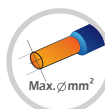

Secção Máx. de cabo sup. em mm
Sección Max de cable sup. en mm
Max. Cable Section sup. in mm
Section de câble max. en mm



Binário Aperto 1,5 Nm
Torque Cierre 1,5 Nm
Starting Torque 1,5 Nm
Couple Serrage 1,5 Nm



Fixação de aparelhos
Fijación de aparatos
Appliances' fixing
Fixation des appareils



651S15V ^{ref.}

Barramento de terra
Borna de terra
Earth terminal blocks
Barrette de "terre"

DIN 57609, VDE 0609-1

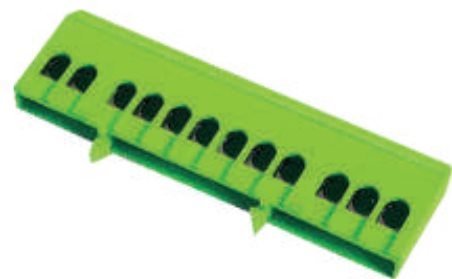

651S15A ^{ref.}

Barramento neutro
Borna de neutro
Neutral terminal blocks
Barrette de "Neutre"

DIN 57609, VDE 0609-1



Pitons de ancoragem para fixação com parafusos em Calha DIN
Agujeros de anclaje para fijación con tornillos en Carril DIN
Anchor piton for equipment fastening fixation with screws in Rail DIN
Pitons d'ancrage pour fixations à vis Rail DIN



Fixação em posição vertical, por pressão, na calha DIN EN 50022.
Totalmente protegidos.
De cor verde para a "terra" e de cor azul para o "neutro".

Upright fixing, by pressure, on the DIN EN 50022 Rail.
Totally protected.
Green colour for the "earth" and blue colour for the "neutral".

Fijación en posición vertical, a presión, en el rail DIN EN 50022.
Totalmente protegidos.
De color verde para la "tierra" y de color azul para el "neutro".

Fixation verticale dans le Rail DIN EN 50022, à pression.
Complètement protégés.
Vert pour la "terre" et bleu pour le "neutre".

651S05 ^{ref.}

Barramento latão 5 entradas
Borna latón 5 entradas
Bus brass barwith 5 entries
Bornier en laiton avec 5 trous



Latão Maciço
Latón Macizo
Brass
Laiton massif



SCAN + INFO

Ref.					Y-X-Z Dim.(mm)
651S15V	12	16	12	12	107 x 13 x 26
651S15A	12	16	15	15	107 x 13 x 26
651S05	05	10	5,5	5,5	36 x 6 x 9

CAIXAS DE CONTADOR E COLUNA MONTANTE

Cajas de derivacion y contador para columna montante
Enclosures for rising column and enclosures for metter counter
Coffrets pour colonne montante et coffrets pour compteur



NORMAS
NORMES
COMPLIANCES

EN 50298
EN 60529
EN 60439
EN 62262
EN 60947-7-1
NP 1272





Termoplástico
Termoplastico
Thermoplastic
Thermoplastique



-5°C
+60°C



Classe de isol. 2
Clase de aisl. 2
Insul. degree 2
Class d' isolation 2



Protecção anti-UV
Protección contra-UV
Anti-UV protection
Protection contre-UV



Chave
Llave
Key
Clé

EN 60439 EN 60670
EN 62208 EN 50298
EN 61439-2

Prep. para todos os tipo de contadores analógicos e digitais.

Prep. p.todo tipo de medidores analógicos y digitales.

Prep. for all types of analog and digital meters.

Prép. p. tous les types de compteurs analogiques et numériques.

PJN 242 ref. ...

Contador monofásico
Contador monofasico
Single unit
Compteur monophasé



Seláveis
Precintable
Can be sealed
Scellage

IP 65 IK 10



Branco e Cinza
Blanco y Gris
White and Grey
Blanche et Gris



Preparados p. telecontagem
Preparados p. recuento remoto
Prepared for remote counting
Préparé pour comptage remote

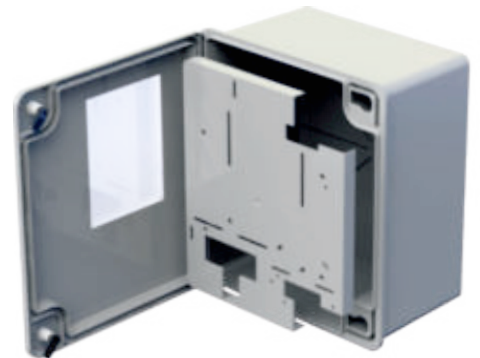

PJN 244 ref. ...

Contador monofásico ou trifásico
Contador monofasico ou trifasico
Single unit or thre phase unit
Compteur monophasé ou triphasé



Seláveis
Precintable
Can be sealed
Scellage

IP 54 IK 10



Branco e Cinza
Blanco y Gris
White and Grey
Blanche et Gris



Preparados p. telecontagem
Preparados p. recuento remoto
Prepared for remote counting
Préparé pour comptage remote

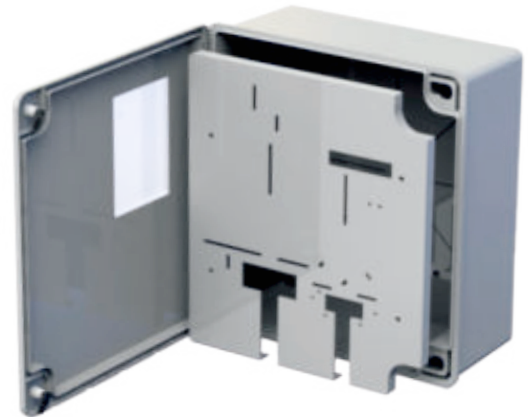

MC 242 ref. ...



Cinza
Gris
Grey
Gris



Placa universal para contadores monofásico, trifásico e tarifa bi-horária,
Placa universal para contadores monofasico trifasico y bihorario
Universal plate for single or three phase meter with or without dual tariff
Platine universelle pour compteur monophasé triphasé et horloge bas tarif

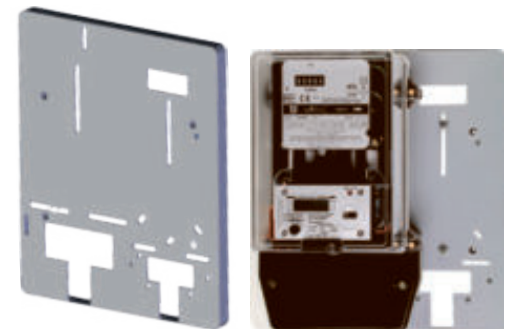

Preparados p. telecontagem
Preparados p. recuento remoto
Prepared for remote counting
Préparé pour comptage remote



SCAN + INFO

Ref.	Dim.ext(mm)	Dim.int(mm)		IP	IK
PJN 242	330 x 280 x 195	322 x 275 x 185		65	10
PJN 244	430 x 390 x 195	422 x 380 x 185		54	10
MC 242	313 x 260 x 20	-	-	-	-

262-CAD/CBQ ^{ref.}

264-CAQ/CBO ^{ref.}

Caixas de coluna encastráveis
Cajas de derivación para columna montante de empotrar
Enclosures for column flush mounting distribution boards
Coffrets pour colonne montante d'encastrement

IP 54 IK 09



262-CAD/CBD 125V
264-CAQ/CBO 200V



Máxima dissipação de potência para aparelhos instalados no seu interior
Máxima dissipación de potencia para aparatos instalados en el interior
Maximum power dissipation for the inside mounted appliances
Dissipation de puissance maximale pour des appareils installés dedans

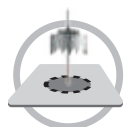

Paredes lisas
Paredes lisas
Flat walls
Murs lisses



Abertura para fechadura do operador tipo
Apertura para cerradura
Opening for lock
Ouverture pour serrure



Moldura ajustável à profundidade da caixa
Moldura ajustable a la profundidad de la caja
Adaptable frame to the box deep
Encadrement adaptable au profondeur du coffret

3 mm



Branco
Blanco
White
Blanche

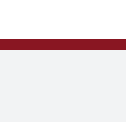

Nivelamento ajustável
Nivelamento ajustable
Adaptable leveling
Nivellement adaptable



Ajust. em profundidade
Ajust. en profundidad
Adjust. in depth
Régl. en profondeur



Embebida
Empotrada
Flush mounted
Encastrée



Saliente em ductos
Saliente en ductos
Surface in ducts
Surface dans des vides



Fixação de aparelhos
Fijación de aparatos
Appliances' fixing
Fixation des appareils

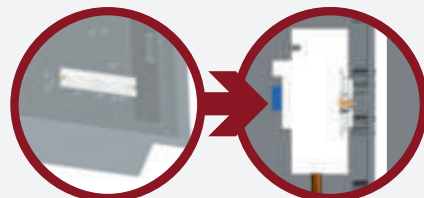

Pitons de ancoragem para fixação com parafusos em Calha DIN (incluída)
Agujeros de anclaje para fijación con tornillos en Carril DIN (incluído)
Anchor piton for equipment fastening fixation with screws in Rail DIN (included)
Pitons d'ancrage pour fixations à vis Rail DIN (inclus)

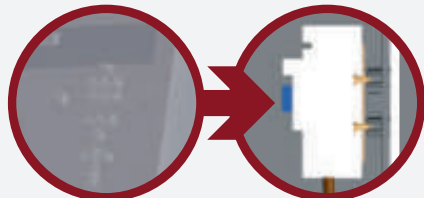

Pitons de ancoragem para fixação com parafusos
Agujeros de anclaje para fijación con tornillos
Anchor piton for equipment fastening fixation with screws
Pitons d'ancrage pour fixations à vis



SCAN + INFO



Capacidades diferentes de acordo com o borne de derivação jsl ; Ref. 266, Ref. 267 ou borne de pilar tradicional
Capacidades diferentes según connector jsl ; Ref. 266, Ref. 267 o borna tradicional de pilar
Different capacities according to the connectors jsl ; Ref. 266, Ref. 267 or traditional pillar terminals
Capacités différentes conforment les connecteurs jsl ; Ref. 266, Ref. 267 ou les bornes traditionnelles à trou

Ref.	Dim.ext (mm)	M3	mm2 Ø	mm2 Ø		(A)	IP	IK
262-CAD/CBQ	395 x 300 x 116	750 °C	8 - 95	6 - 20	1 - 2	32 - 63	54	09
264-CAQ/CBO	550 x 415 x 116	750 °C	25-150	6 - 25	1 - 4	32 - 63	54	09



Latão Maciço
Latón Macizo
Brass
Laiton massif



-15°C
+90°C



Fixação por parafusos
Fijación por tornillos
Fixing by screws
Fixation par des vis



Binário Aperto
Torque Cierre
Starting Torque
Couple Serrage



Cabo de coluna
Cable columna
Pillar cable
Câble de colonne



Cabo de derivação
Cable de derivación
Junction cable
Câble de dérivation



Nº de cabos
Nº de cables
Nr of cables
Nº de cables



SCAN + INFO

266

ref.

Borne Latão Maciço
Borna Latón Macizo
Brass terminal
Borne Laiton massif



Binário de ap.max. 250 Ncm
Binário max. 250 Ncm
Maximum torque 250 Ncm
Couple maximale 250 Ncm

267

ref.

Borne Latão Maciço
Borna Latón Macizo
Brass terminal
Borne Laiton massif



265

ref.

5x + 1x

Placa de bornes Universal (269) + 5 bornes (266)
Placa de bornas Universal (269) + 5 bornas (266)
Connectors Universal base (269) + 5 terminals (266)
Basse de Bornes universelle Connecteurs (269) + 5 bornes (266)



Binário de ap.max. 250 Ncm
Binário max. 250 Ncm
Maximum torque 250 Ncm
Couple maximale 250 Ncm

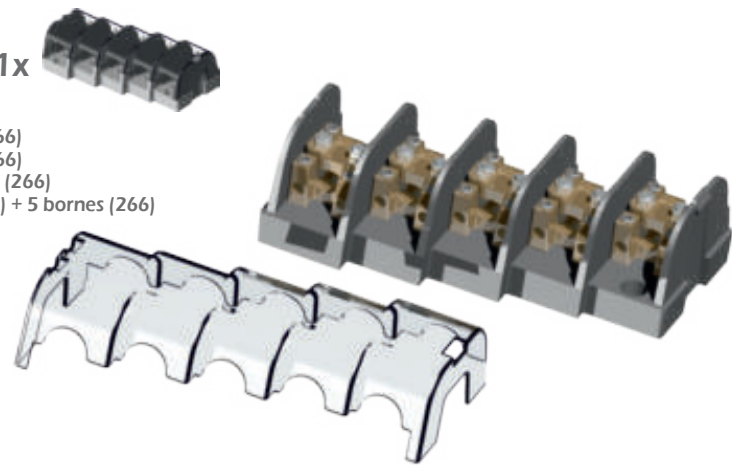

269

ref.

BASE PARA BORNES 265 VAZIA

Recebe até 5 bornes (REF.266) Tampa de recobrimento e protecção transparente. Agrupamento de Neutro, Terra, L1, L2 e L3. I máx 63 A- V máx 415 V Fácil de instalar e segura. A sua morfologia facilita a passagem dos cabos. Livre de halogéneos.

BASE PARA BORNAS 265 VACIA

Recibe hasta 5 bornas (REF.266) con Tapa de protección transparente Neutro, Tierra, L1, L2 y L3, agrupados. I max 63 A- V max 415 V Gran facilidad de instalación Segura. y Libre de halogenos. Su diseño facilita el paso de los cables.

EMPTY BASE FOR TERMINAL 265

For up to 5 terminals (REF.266) Transparent protective cover. Neutral, Earth, L1, L2 and L3, together. I max 63 A- V max 415 V Easy instalation, Safe and Hallogen free. Its design allows cables crossing.

BASE POUR BORNE 265 VIDE

Pour jusqu'à 5 bornes (REF.266) Couvercle de protection transparent. Neutre, Terre, L1, L2 et L3, regroupés. I max 63 A- V max 415 V- Très facile à installer, Très sûr et Sans halogènes. Sa morphologie facilite le passage des cables.

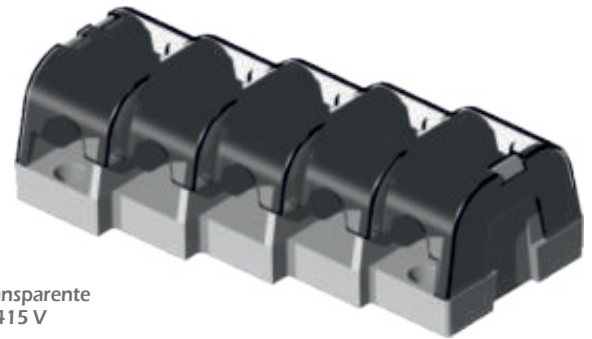

Ref.	A	B	C	D	E	F	G	H
265	170	70	132,5	6	52	54,5	36,5	5,8
267	50	70	69	57	37			

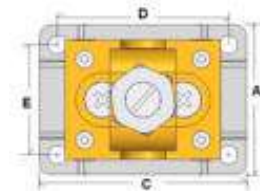
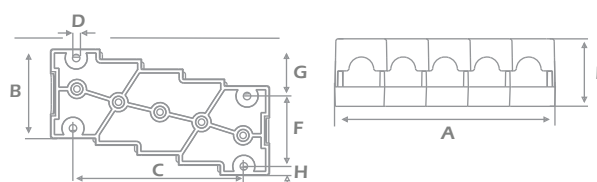

Ref.	Dim.ext (mm)	mm ² Ø	mm ² Ø	Nº	← B max
266	-	8 - 95	6 - 20	1 - 4	250 Ncm
267	-	25-150	6 - 25	1 - 4	250 Ncm
265	28 x 35 x 28	8 - 95 (x5)	6 - 20 (x5)	1 - 4 (x5)	250 Ncm

MATERIAL DE FIXAÇÃO

Fijaciones
Fixing materials
Matériel de fixation





Termoplástico
Termoplastic
Thermoplastique



Preto | Cinza | Creme
Negro | Gris | Crema
Black | Grey | Cream
Noir | Gris | Crème



Agrupável
Apilable
Stackable
Empilable



Aceita Bucha
Acepta Taco
Recieves Dowel
Receus Cheville



Aplicação por pressão
Aplicación presión
Pressure application
Aplication à pression



Tubo VD
Tubo VD
VD Conduits
Conduits VD



Tubo PG
Tubo PG
PG Conduits
Conduits PG



Tubo Hidraulico
Tubo Hidraulico
Hydraulic Conduits
Conduits Hydrauliques



DOWNLOAD DA BROCHURA DIGITAL
DESCARGAR DA BROCHURA DIGITAL
DOWNLOAD THE DIGITAL BROCHURE
TÉLÉCHARGER LA BROCHURE DIGITAL

NOVO
NEW

SUPER T

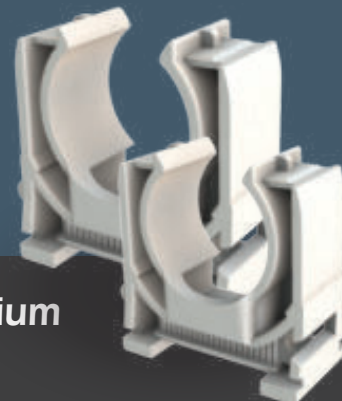

Abraçadeira Premium | Abrazadera Premium Premium Saddle | Attache Premium

Abraçadeiras agrupáveis para tubos VD
Abrazaderas enlazables para tubos VD
Stackable saddles for VD conduits
Attache empilables pour conduits VD



Agrupável
Apilable
Stackable
Empilable

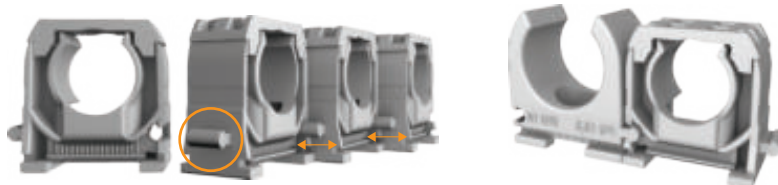

-5°C
+40°C

Retro-Compatibilidade: Compatível com os restantes modelos de abraçadeiras agrupáveis da JSL
Retrocompatibilidad: Compatible con todos los demás modelos de abrazaderas apilables JSL
Retro-Compatibility: Compatible with all other JSL grouping saddle models
Rétro-Compatibilité : Compatible avec tous les autres modèles de cheville empilable JSL



ST COVER



Clip & Lock

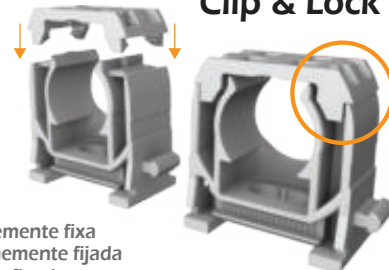

Tampa opcional concebida para impedir a remoção mantendo a instalação firmemente fixa
Cubierta opcional diseñada para evitar su retirada y mantener la instalación firmemente fijada
Optional cover designed to prevent removal while keeping the installation firmly fixed
Couvertures optionnelles conçues pour empêcher le retrait tout en maintenant l'installation fermement fixée



Micro ajustamento com 10 passos
Micro ajuste con 10 pasos
Micro Adjustment with 10 steps
Micro réglage à 10 étapes



10mm de total amplitude | 10 mm de amplitud total
10 mm total amplitude | Amplitude totale 10 mm



Compatível com calha 2060-PF de aço zincado (DIN C11)
Compatible con el carril de acero galvanizado 2060-PF (DIN C11)
Compatible with 2060-PF galvanized steel rail (DIN C11)
Compatible avec le rail en acier galvanisé 2060-PF (DIN C11)

TAMPAS SUPER-T | CUBIERTAS SUPER-T
SUPER-T COVERS | COUVERTURE SUPER-T



Tampa concebida para impedir a remoção mantendo a instalação firmemente fixa
Cubierta diseñada para evitar su retirada y mantener la instalación firmemente fijada
Covers designed to prevent removal while keeping the installation firmly fixed
Couvertures conçues pour empêcher le retrait tout en maintenant l'installation fermement fixée

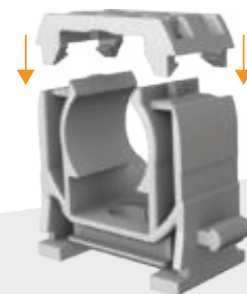

Tensão Extra
Tensión Extra
Extra Clipping Grip
Poignée supplémentaire

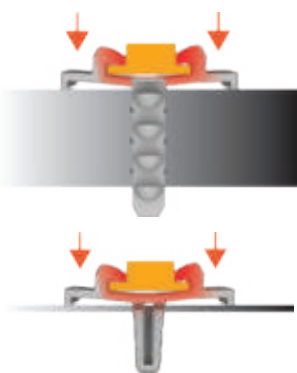

ACESSÓRIOS DE FIXAÇÃO | ACCESORIOS PARA FIJACIÓN
FIXING ACCESSORIES | ACCESSOIRES POUR FIXATION



POSIÇÃO FIXA | POSICIÓN FIJA
FIXED POSITION | POSITION FIXE

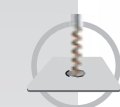

Furo de Ø 6mm
Agujero de Ø 6mm
6mm hole
Trou 6mm

MICRO AJUSTAMENTO COM 10 PASSOS | MICRO AJUSTE CON 10 PASOS
MICRO ADJUSTMENT WITH 10 STEPS | MICRO RÉGLAGE À 10 ÉTAPES



10mm de total amplitude | 10 mm de amplitud total
10 mm total amplitude | Amplitude totale 10 mm

Bucha rápida simples
Taco rápido simple
Quick Dowels
Chevilles rapides

PST-7 NEW ref.



PST-5 NEW ref.

27 mm



Bucha rápida ajustável
Taco rápido ajustable
Adjustable quick dowels
Chevilles rapides réglables

PSTB-4 NEW ref.



PSTB-7 NEW ref.



ST-BASE

Instalação à superfície
Instalación en superficie
Surface installation
Installation en surface

Instala-se aplicando cola prego
Se instala aplicando pegamento para clavos
Installed by applying nail glue
Installé en appliquant de la colle à clous

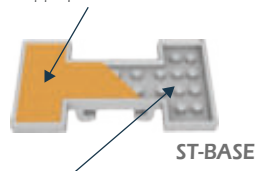

ST-BASE

Textura com mais área de aderência
Textura con más superficie de agarre
Texture with more adhesion area
Texture avec plus de surface de préhension



Também adequadas para a instalação/fixação da série Boxline em betão

También es adecuado para la instalación/fijación de la serie Boxline en hormigón

Also suitable for installing/fixing the Boxline series in concrete

Convient également pour l'installation/fixation de la série Boxline dans le béton.

ST-CLIP NEW ref.



Clip para chapa metálica perfurada
Clip para chapa metálica perforada
Clip for perforated sheet metal
Clip pour plaques métalliques

ST-BASE NEW ref.



Base ajustável para usar com cola
Base ajustable para usar con pegamento
Adjustable base to use with glue
Base réglable pour l'utilisation de la colle



Ref.	VD Métric	PG	Hidrau.	TAMPAS CUBIERTAS COVERS COUVERTURE	PST-5	PST-7	PSTB-4	PSTB-7	ST-CLIP	ST-BASE
ST-16	16	11	-	STC-16	✓	✓	✓	✓	✓	✓
ST-20	20	13,5	19	STC-20	✓	✓	✓	✓	✓	✓
ST-25	25	-	23	STC-25	✓	✓	✓	✓	✓	✓
ST-32	32	-	29	STC-32	✓	✓	✓	✓	✓	✓
ST-40	40	-	36	STC-40	✓	✓	✓	✓	✓	✓



SCAN + INFO

ACESSÓRIOS COMPATÍVEIS DE FIXAÇÃO
ACCESORIOS DE FIJACIÓN COMPATIBLES
COMPATIBLE FIXING ACCESSORIES
ACCESSOIRES DE FIXATION COMPATIBLES

BM6 ref.



903 ref.



215 ref.





Termoplástico
Termoplastico
Thermoplastic
Thermoplastique



Preto | Cinza | Creme
Negro | Gris | Crema
Black | Grey | Cream
Noir | Gris | Crème



Agrupável
Apilable
Stackable
Empilable



Aceita Bucha
Acepta Taco
Recieves Dowel
Receus Cheville



Bucha incluída
Taco incluido
Dowel included
Cheville inclús



Aplicação por pressão
Aplicación presión
Pressure application
Application à pression



2035/D ^{ref.}

2036/D ^{ref.}

2037/D ^{ref.}



Cinza
Gris
Grey
Gris

Abraçadeiras de serrilha agrupáveis/ bucha M6 rápida
Abrazaderas de cierre agrupables con taco M6 rapido
Pressure saddles for cable with M6 fast dowell
Attache a pression a justaposer pour câble avec cheville M6 rapide

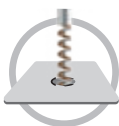

Furo de Ø 6mm
Agujero de Ø 6mm
6mm hole
Trou 6mm



-15°C
+90°C



Bucha incluída
Taco incluido
Dowel included
Cheville inclús

Ref.	Ø cab.(mm)
2035/D	6-13
2036/D	12-20
2037/D	16-26

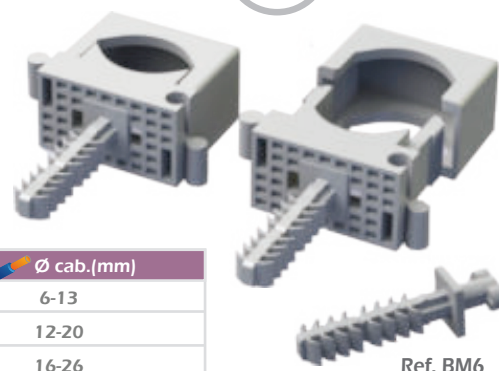

Ref. BM6

Série 2030 ^{ref.}

Abraçadeiras agrupáveis de serrilha
Abrazaderas de cierre enlazables
Stackable Pressure saddles for cables
Attache pour câbles Empilable à pression
à justaposer



Agrupável
Apilable
Stackable
Empilable



Aceita Bucha
Acepta Taco
Recieves Dowel
Receus Cheville



Preto | Cinza | Creme
Negro | Gris | Crema
Black | Grey | Cream
Noir | Gris | Crème



Fixação com:
Fijacion con:
Mounting with
Fixation avec:

Ref.	Ø cab.(mm)
2035	6 - 13
2036	12 - 20
2037	16 - 26
2038	18 - 30
2039	27 - 43

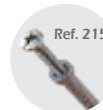

Ref. 215

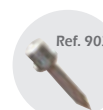

Ref. 903

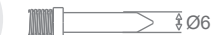

Série 2030 ^{ref.}



Série 200 ^{ref.}

SCAN + INFO

204/D ^{ref.}

208/D ^{ref.}

211/D ^{ref.}



Cinza
Gris
Grey
Gris

Abraçadeiras agrupáveis para cabos e tubos série 200 c/ bucha M6 rápida
Abrazaderas para cables y tubo enlazables serie 200 c/ taco M6 rapido
Saddles type 200 (for cable and/or conduit) with M6 fast dowell
Attache type 200 (pour câble et/ou conduit) avec cheville M6 rapide

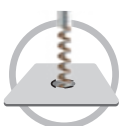

Furo de Ø 6mm
Agujero de Ø 6mm
6mm hole
Trou 6mm



-30°C
+90°C



Bucha incluída
Taco incluido
Dowel included
Cheville inclús

Ref.	Ø (mm)	VD Métric	PG	Hidrau.
204/D	19,4	20	13,5	19
208/D	24,3	25	-	23
211/D	15,3	16	11	-



Ref. BM6



Termoplástico
Termoplastico
Thermoplastic
Thermoplastique



Preto | Cinza | Creme
Negro | Gris | Crema
Black | Grey | Cream
Noir | Gris | Crème



Agrupável
Apilable
Stackable
Empilable



Aceita Bucha
Acepta Taco
Receives Dowel
Receus Cheville



Aplicação por pressão
Aplicación presión
Pressure application
Application à pression



Tubo VD
Tubo VD
VD Conduits
Conduits VD



Tubo PG
Tubo PG
PG Conduits
Conduits PG



Tubo Hidraulico
Tubo Hidraulico
Hydraulic Conduits
Conduits Hydrauliques



Série 200 ref.



Série 100 ref.



SCAN + INFO

Série 200 ref.

Abraçadeiras agrupáveis para cabos e tubos série 200
Abrazaderas para cables y tubo enlazables serie 200
Saddles type 200 for cable and/or conduit
Attache type 200 pour câble et/ou conduit



Agrupável
Apilable
Stackable
Empilable



-30°C
+90°C



Ref.	VD Métric	PG	Hidrau.
201	12	-	11
202	-	9	13,5
211	16	11	-
203	-	-	16
204	20	13,5	19
205	-	16	21
208	25	-	23
206	-	21	-
209	32	-	29
207	-	29	-
210	40	-	36
	VD Métric	PG	Hidrau.



Fixação com:
Fijacion con:
Mounting with
Fixation avec:

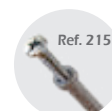

Ref. 215



Ref. 903



Série 100 ref.

Abraçadeiras agrupáveis para cabos e tubos série 100
Abrazaderas para cables y tubo enlazables serie 100
Saddles type 100 for cable and/or conduit
Attache type 100 pour câble et/ou conduit

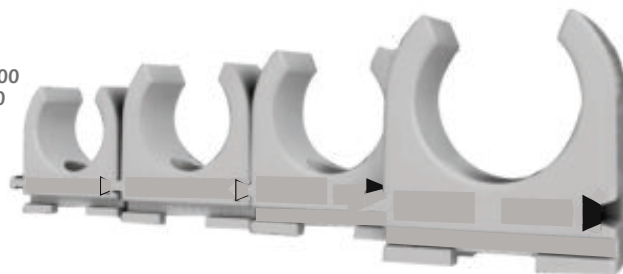

Agrupável
Apilable
Stackable
Empilable



-15°C
+90°C



Ref.	VD Métric	PG	Hidrau.
100	12	-	-
101	-	-	11
102	16	9	13,5
103	-	11	16
104	20	13,5	19
105	-	16	-
106	-	21	23
107	40	29	36
108	50	36	-
109	-	42	-
110	63	48	-
	VD Métric	PG	Hidrau.



Fixação com:
Fijacion con:
Mounting with
Fixation avec:

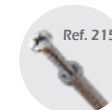

Ref. 215



Ref. 903

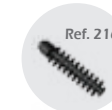

Ref. 216





Termoplástico
Termoplastico
Thermoplastic
Thermoplastique



-15°C
+90°C



Agrupável
Apilable
Stackable
Empilable



Aceita Bucha
Acepta Taco
Receives Dowel
Receus Cheville



Aplicação por pressão
Aplicación presión
Pressure application
Application à pression



Para usar com Cabos
Para uso con Cables
To use on Cables
Utilizer avec des câbles

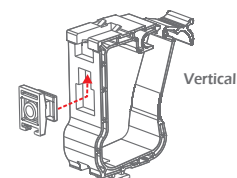

Vertical

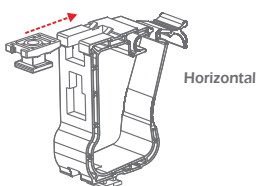

Horizontal

710-15 ref.

710-30 ref.



Série 300 ref.



SCAN + INFO

710-15 ref.

710-30 ref.

Porta-cabos de fixação vertical ou lateral
Puerta cables de fijación vertical o lateral
Cable fixing capable of vertical or lateral fixation
Attache à cable de fixation latérale ou verticale

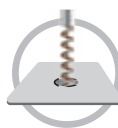

Furo de Ø 6mm
Agujero de Ø 6mm
6mm hole
Trou 6mm



-25°C
+90°C

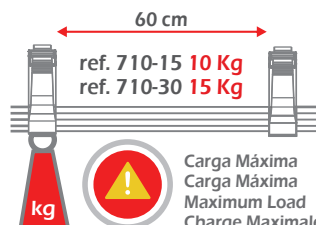
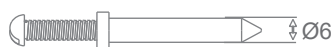
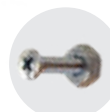
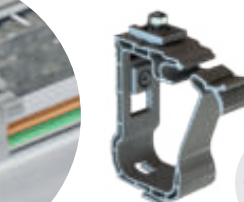
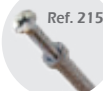
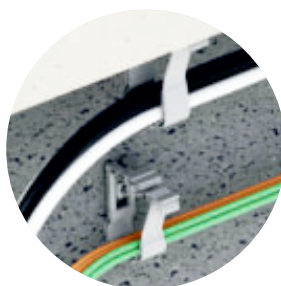

ref. 710-15 10 Kg
ref. 710-30 15 Kg



Carga Máxima
Carga Máxima
Maximum Load
Charge Maximale

Ref.	Dim. (mm)
710 -15	80x52x26
710 -30	119x59x26

Série 300 ref.

Abraçadeiras aperto mecânico (parafuso metálico)
Abrazaderas con apertura mecánica (tornillo metálico)
Mechanical Aperture Saddles (metallic screws)
Attache pour câbles mécanique (vis métallique)



Parafusos de aço zincado
Tornillos de acero zincado
Stell zined plated Screws
Vis en Acier



Preto | Cinza | Creme
Negro | Gris | Crema
Black | Grey | Cream
Noir | Gris | Crème

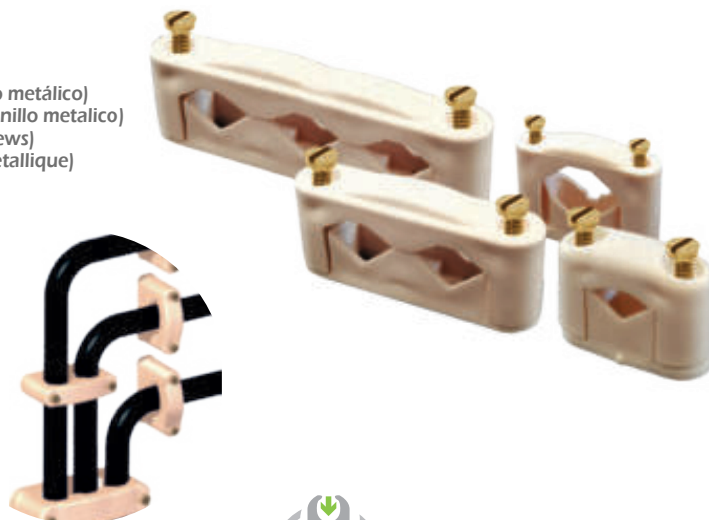

Fixação com:
Fijacion con:
Mounting with
Fixation avec:

Ref.	Ø cab. (mm)
305	6 - 14
306	6 - 17
307	15 - 28
308	30 - 40
309	40 - 63
305/2	2 x 7 - 14
306/2	2 x 10 - 18
305/3	3 x 7 - 14
306/3	3 x 10 - 18

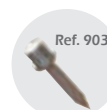
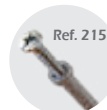



Termoplástico
Termoplastico
Thermoplastic
Thermoplastique



-15°C
+90°C



Agrupável
Apilable
Stackable
Empilable



Aceita Bucha
Acepta Taco
Receives Dowel
Receus Cheville



Aplicação por pressão
Aplicación presión
Pressure application
Application à pression



Para usar com Cabos
Para uso con Cables
To use on Cables
Utilizer avec des câbles



Série 900 ^{ref.}

Abraçadeiras aperto mecânico (parafuso nylon)
Abrazaderas con apertura mecánica (tornillo nylon)
Mechanical Aperture Saddles (nylonscrews)
Attache pour câbles mécanique (vis nylon)



Parafuso em Nylon
Tornillo en Nylon
Nylon Screw
Devis en Nylon



Cinza | Creme
Gris | Crema
Grey | Cream
Gris | Crème



Fixação com:
Fijacion con:
Mounting with
Fixation avec:

Ref.	Ø cab.(mm)
905	5 - 14
906	8 - 17
907	15 - 25
908	20 - 33
905/2	2 x 5 - 14
906/2	2 x 6 - 17

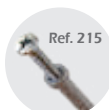

Ref. 215

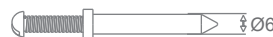

Ref. 903



Estas abraçadeiras são especialmente utilizáveis em atmosferas corrosivas e ambientes marítimo e salino
Estas abrazaderas son especialmente adecuadas para atmosferas corrosivas y ambientes marítimo y salino
These saddles are specially designed for corrosive atmospheres and seaside environments
Ces attaches sont spécialement appropriées pour des atmosphères corrosives et des environnements maritimes et salés

Série 500 ^{ref.}

Abraçadeiras para cabos tipo clip
Abrazaderas para cables tipo clip
Clip type Saddles for cables
Clipsotubes pour les cables



Aplicação por pressão
Aplicación presión
Pressure application
Application à pression



Cinza | Branco
Gris | Blanco
Grey | White
Gris | Blanche



Fixação com:
Fijacion con:
Mounting with
Fixation avec:

Ref.	Ø cab.(mm)
511	8-10
512	10-12
513	12-14
514	13,5-15
515	15-17
516	16-19
517	19-22
518	22-25
519	25-28
511/2	2 x 8-10
512/2	2 x 10-12
513/2	2 x 12-14
514/2	2 x 13,5-15
515/2	2 x 15-17
516/2	2 x 16-19
517/2	2 x 19-21

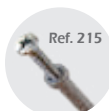

Ref. 215



Ref. 903



Ref. 216



Série 900 ^{ref.}



Série 500 ^{ref.}

SCAN + INFO

Série 2000 ^{ref.}

Abraçadeiras para calha (montagem em guia C11)
 Abrazaderas para montaje em guia (montage em guia C11)
 Cable saddle for C11 rail
 Attaches pour rail C11

Cinza | Creme | Preto
 Gris | Crema | Negro
 Grey | Cream | Black
 Gris | Crème | Noir

-15°C
 +90°C

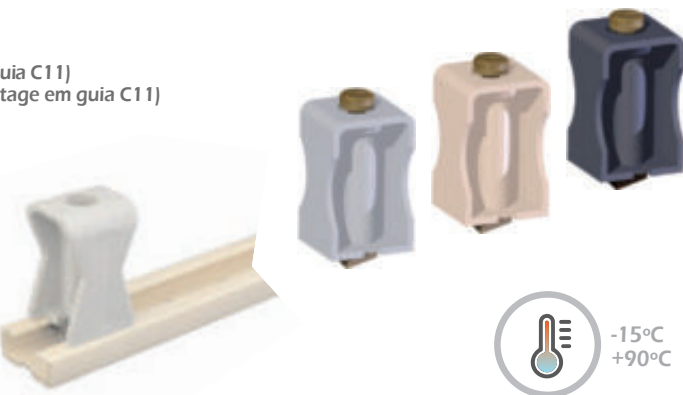

Ref.	← Ø cab.(mm) →
2050	6 - 24 / 6 - 24
2051	8 - 36 / 8 - 36
2054	14 - 48 / 14 - 48
2051-U	6 - 24 / 8 - 36
2054-U	8 - 36 / 14 - 48

* Sem parafuso | Sin tornillo | Without screw | Sans vis

Termoplástico
 Termoplastico
 Thermoplastic
 Thermoplastique

Nylon

Aço Zincado
 Acero Zincado
 Zinc Plated Steel
 Acier Zingué

Para usar com Cabos
 Para uso con Cables
 To use on Cables
 Utilizer avec des câbles

Agrupável
 Apilable
 Stackable
 Empilable

Parafusos de aço zincado
 Tornillos de acero zincado
 Stell zined plated Screws
 Vis en Acier

2060-PF ^{ref.}

Calha de aço zincado galvanizada (perfil DIN C11)
 Guia de acero galvanizado (perfil DIN C11)
 Galvanized Metal DIN C11 rail
 Rail DIN C11 métallique galvanisé

Aço Zincado
 Acero Zincado
 Zinc Plated Steel
 Acier Zingué

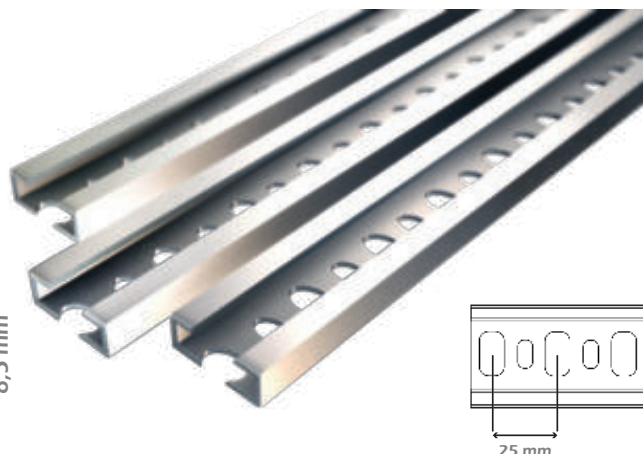
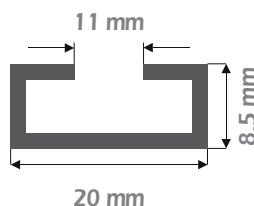

Ref.	Ext. (mm)	Int. (mm)	Dim. (m)
2060-PF	20	11	2

031 ^{ref.} 032 ^{ref.}

Abraçadeira agrupável tipo "Universal" para alta temperatura
 Grapilla enlazable tipo "Universal" para alta temperatura
 Cable clip "Universal" type for high temperature
 Embase type "Universe!" pour haute temperature

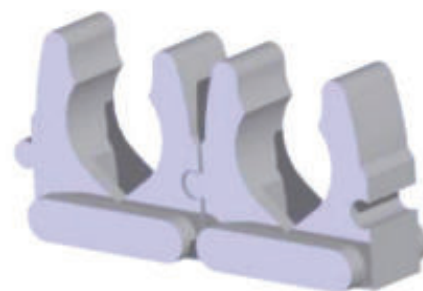
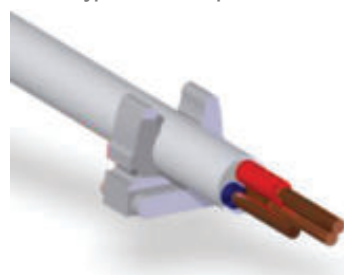

Nylon

Cinza | Branco
 Gris | Blanco
 Grey | White
 Gris | Blanc

Agrupável
 Apilable
 Stackable
 Empilable

-25°C
 +115°C

Abraçadeira para alta temperatura
 Abrazadera para alta temperatura
 High temperature clip saddle
 Attache pour haute temperature

Ref.	cab.(mm)
031	16 - 22
032	25 - 28

Série 2000 ^{ref.}



031 ^{ref.} 032 ^{ref.}



SCAN + INFO

Série 3000 ref.

Abraçadeiras de prego em aço temperado para betão (Ks006)
 Grapilla con clavo de acero templado para hormigón (Ks006)
 Cable clips with hardened steel nail for concrete (Ks006)
 Attaches à clou en acier trempé pour le béton (Ks006)



Prego de aço temperado para betão (Ks006)
 Clavo de acero templado para hormigón (Ks006)
 Quality hardened steel nail for concrete (Ks006)
 Clous en acier trempé pour le béton (Ks006)



Branco
Blanco
White
Blanche

Ref.	Ø cab.(mm)	L x Ø (mm)
3005/18	5	18 x 2,0
3006/18	6	18 x 2,0
3007/18	7	18 x 2,0
3008/20	8	18 x 2,0
3009/20	9	18 x 2,0
3010/25	10	25 x 2,0
3011/25	11	25 x 2,0
3012/25	12	25 x 2,0
3014/40	14	40 x 2,5
3016/40	16	40 x 2,5
3018/40	18	40 x 2,5
3020/40	20	40 x 2,5
3009/20	9	18 x 2,0
3009/25	9	25 x 2,0



Termoplástico
Termoplastico
Thermoplastic
Thermoplastique



Nylon



Branco
Blanco
White
Blanche



-25°C
+90°C



Cinza | Crema
Gris | Crema
Grey | Cream
Gris | Crème



Para usar com Cabos
Para uso con Cables
To use on Cables
Utilizer avec des câbles

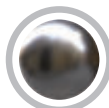

Aço temperado zincado
Acero templado zincado
Hardened steell Zinc Plated
Acier trempé zingué



Protecção anti-UV
Protección contra-UV
Anti-UV protection
Protection contre-UV



Abraçadeira de Fivela - Brida - Cable Ties - Colliers

Abraçadeira para alta temperatura em nylon
 Brida de nylon para alta temperatura
 Nylon High temperature cable ties
 Colliers en nylon pour haute temperature



-25°C
+120°C



Nylon



Preto | Branco
Negro | Blanco
Black | White
Noir | Blanc

Ref.	Ø (mm)	Dim. (mm)
461	1,8 - 16	2,5 x 95
462	1,6 - 35	2,5 x 140
463	1,6 - 44	2,5 x 180
464	1,6 - 31	3,5 x 140
465	1,6 - 44	3,5 x 180
466	1,6 - 30	5,0 x 120
470	3,0 - 50	5,0 x 200
467	3,0 - 75	5,0 x 275
468	3,0 - 75	9,0 x 275
469	5,0 - 92	9,0 x 350



Elevada protecção anti-UV
 Alta protección contra-UV
 High anti-UV protection
 Haute protection contre-UV



Série 3000 ref.

Abraçadeira de Fivela - Brida
 Cable Ties - Colliers



SCAN + INFO



Termoplástico
Termoplastico
Thermoplastic
Thermoplastique



-25°C
+90°C



Para usar com Cabos
Para uso con Cables
To use on Cables
Utilizer avec des câbles

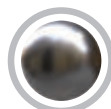

Aço temperado zincado
Acero templado zincado
Hardened steel Zinc Plated
Acier trempé zingué



RoHS



REACH

HF
HALOGEN FREE

CE

Série 700 ^{ref.}

Abraçadeiras tipo universal c/ prego de aço temperado para betão (Ks006)
Grapillas c/ clavo de acero templado para hormigón (Ks006) tipo universal
Cable clips with hardened steel nails for concrete (Ks006) universal type
Attaches à clou en acier trempé pour le béton (Ks006) type universel



Branco
Blanco
White
Blanche



Ref.	Ø cab.(mm)	L x Ø (mm)
700/2,5-4	2,5 - 4	20 x 1,5
700/5-7	5 - 7	20 x 2,0
700/8-10	8 - 10	25 x 2,0
700/11-15	11 - 15	35 x 2,0
700/16-19	16 - 19	40 x 2,5
700/23-29	23 - 29	40 x 2,5

NOVO
NEW

700S ^{ref.}

Abraçadeiras tipo universal c/ prego de aço temperado embutido em bucha para betão (Ks006)
Grapillas tipo universal c/ clavo de acero templado embutido en casquillo para hormigón (Ks006)
Universal cable clips with hardened steel nail embedded in bushing for concrete (Ks006)
Attaches à clou en acier trempé chevilles pour le béton (Ks006)



Branco
Blanco
White
Blanche



Ref.	Ø cab.(mm)	L x Ø (mm)
700S	16 - 20	40 x 2,5

NOVO
NEW

700D ^{ref.}

Abraçadeiras dupla tipo universal c/ prego de aço temperado embutido em bucha para betão (Ks006)
Grapillas duplas tipo universal c/ clavo de acero templado embutido en casquillo para hormigón (Ks006)
Universal Double cable clips with hardened steel nail embedded in bushing for concrete (Ks006)
Double Attaches à clou en acier trempé chevilles pour le béton (Ks006)



Branco
Blanco
White
Blanche



Ref.	Ø cab.(mm)	L x Ø (mm)
700D	(16 - 20) x2	40 x 2,5

701/TV ^{ref.}

Abraçadeiras TV c/ prego de aço temperado (Ks006) para cabo coaxial
Grapilla c/ clavo de acero templado (Ks006) para cable coaxial
Cable clip w/ hardened steel nail (Ks006) for coaxial cables
Attache à clou en acier trempé (Ks006) pour cables coaxiales



Branco
Blanco
White
Blanche



Ref.	Ø cab.(mm)	L x Ø (mm)
701/TV	Cabo Coaxial RG6 TV Cable RG6 Cable TV RG6	30 x 2,0

Série 702 ^{ref.}

Abraçadeiras plana c/ prego aço temperado (Ks006) - Cabo plano
Grapilla c/clavo acero templado (Ks006) - Cabo paralelo
Cable clip with hardened steel nail (Ks006) - Flat cable
Attache à clou en acier trempé (Ks006) - Câble méplat



Branco
Blanco
White
Blanche



Ref.	cab.(mm ²)	L x Ø (mm)
702/0	2 x 0,75	15 x 1,5
702/1	2 x 1	15 x 1,5
702/2	2 x 1,5	25 x 2,0
702/3	2 x 2,5	25 x 2,0



SCAN + INFO



Nylon 6

-15°C
+150°CPreto
Negro
Black
NoirBranco
Blanco
White
Blanc

Accessórios para abraçadeiras de fivela - Accesorios para bridas
Fixing accessories for cable ties - Accessoires pour colliers

111

ref.

Preto
Negro
Black
Noir

112

ref.

Preto
Negro
Black
Noir

113

ref.

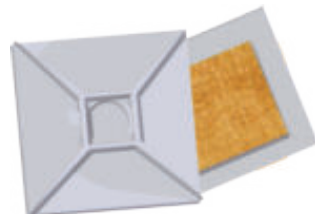
Branco
Blanco
White
Blanc

113-A

ref.

Branco
Blanco
White
Blanc

Ref.	Desc.
111	Perno tipo bucha (Ø 8 mm) Taco (Ø 8 mm) Wall plug (Ø 8 mm) Embase à cheville (Ø 8 mm)
112	Base p/ bucha e parafuso Base para taco e tornillo Fixing base for plug and screw Embase pour cheville et vis
113	Base Auto-adesiva (banda adesiva 3M de alta resistência) Base autoadesiva (adesivo 3M de alta resistencia) Self adhesive Base (3M high resistance adhesive tape) Embase auto-adhésif (bande adhésif 3M haute résistance)
113-A	Base Não Adesiva Base No Adhesiva Non Adhesive Base Embase non adhésif

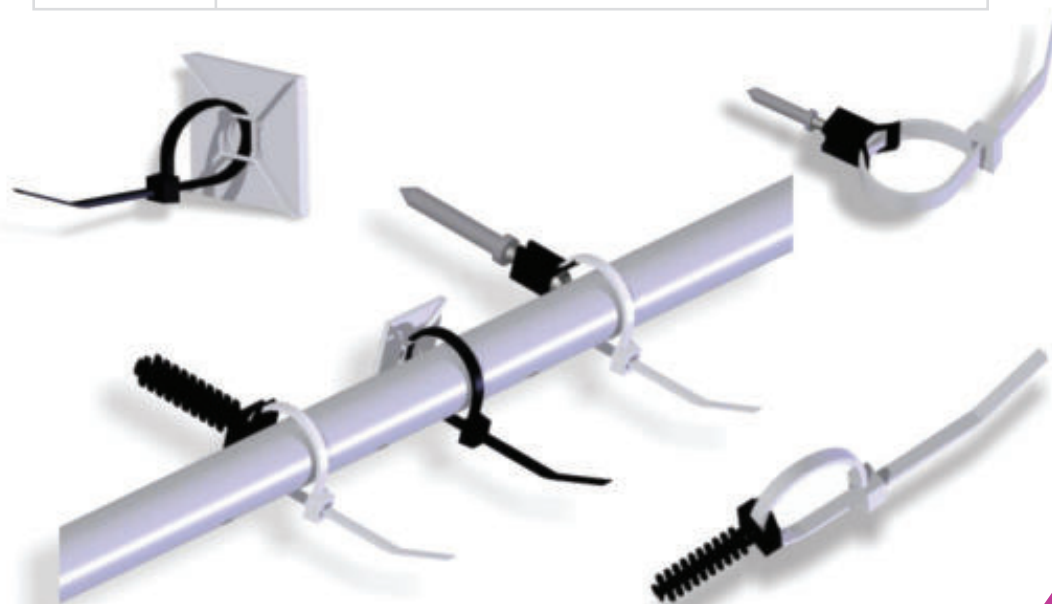

SCAN + INFO



Nylon 6



Preto | Cinza
Negro | Gris
Black | Grey
Noir | Gris



SCAN + INFO

Accesórios de fixação - Accesorios para fijación
Fixing accessories - Accessoires pour fixation

215 ref.



Cinza
Gris
Grey
Gris

-15°C
+150°C

216 ref.



Preto
Negro
Black
Noir

-15°C
+150°C

BM6 ref.



Cinza
Gris
Grey
Gris

-15°C
+150°C

Ref.	Desc.
215	Bucha 6 mm com parafuso tipo prego Taco expansión 6 mm con tornillo clavo 6 mm plug with screwing nail Cheville 6 mm avec clou vissé
216	Perno Nylofix M6 Perno Nylofix M6 Dowel Nylofix M6 Goujon en Nylon M6
BM6	Bucha quick 6 mm Taco con 6 mm 6 mm plug Cheville 6 mm

Buchas de expansão - Tacos - Dowels - Chevilles



505 ref.



506 ref.



507 ref.



508 ref.



510 ref.

-5°C
+90°C

Cinza
Gris
Grey
Gris



Ref.	Ø (mm)	Ø (mm)
505	5	3 - 4,5
506	6	3 - 5,5
507	7	3 - 5,6
508	8	5 - 7
510	10	6 - 9

Pernos de aço zincado a branco M6
Pernos de acero zincado blanco M6
White zinc plated Steel plugs M6
Goujons en acier zingué blanc M6



903/18 ref.



903/25 ref.



903/30 ref.



903/40 ref.



903/55 ref.



903/70 ref.



Aço temperado
Acero templado
Hardened steel
Acier galvanisé



Zincado a branco
Zincado blanco
white Zinc plated
Acier Zingué blanc



Ponta redonda e gola
Punta redonda y cuello
Wide collar
Bout rond et jante



Rosca M6
M6 thread
Filetage M6

Ref.	Dim.
903/18	18 mm
903/25	25 mm
903/30	30 mm
903/40	40 mm
903/55	55 mm
903/70	70 mm



SCAN + INFO

TUBO E ACESSÓRIOS

Tubo y accesorios
Conduits and fittings
Conduits et accessoires

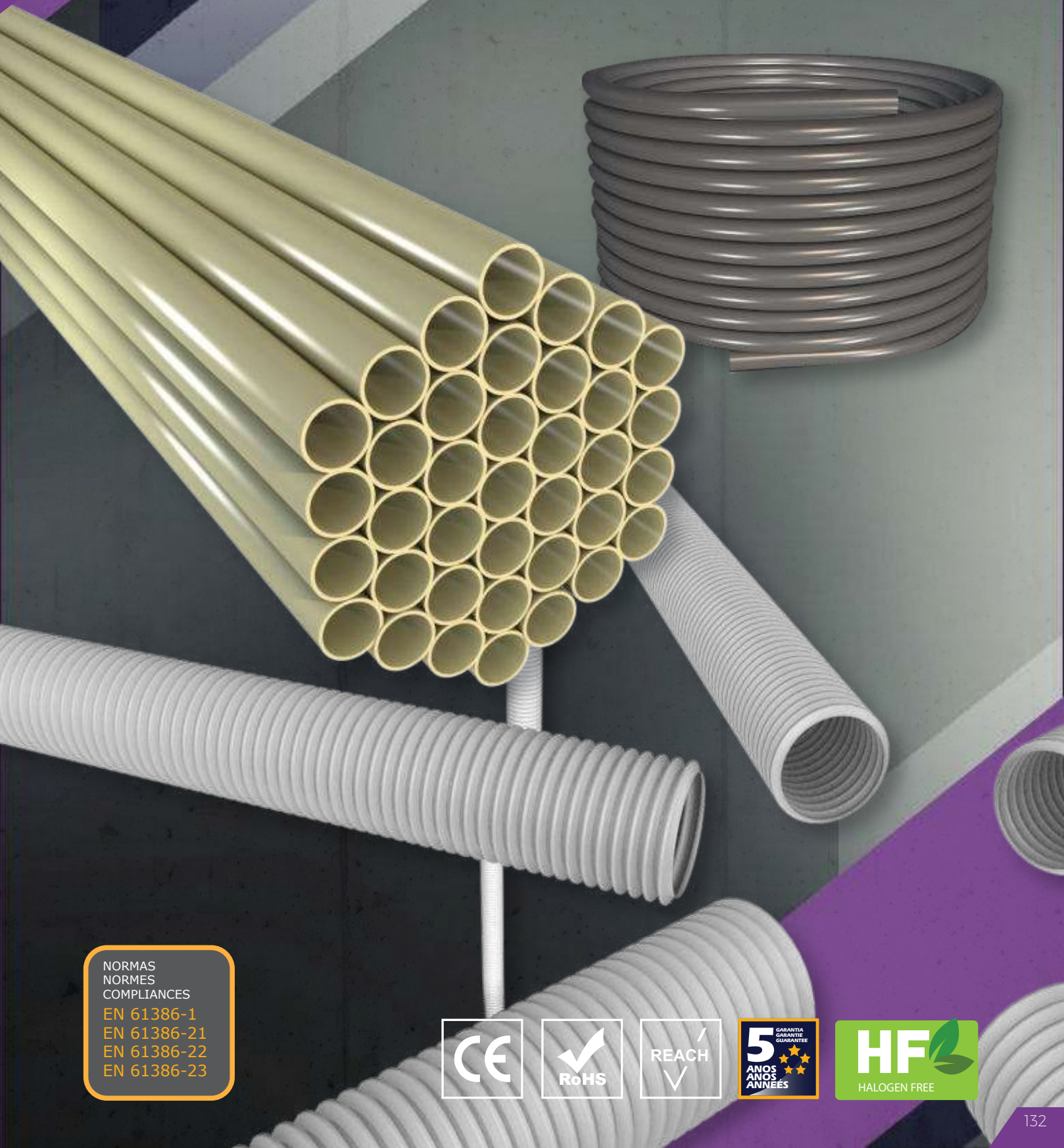

NORMAS
NORMES
COMPLIANCES

EN 61386-1
EN 61386-21
EN 61386-22
EN 61386-23





Termoplástico
Termoplastico
Thermoplastic
Thermoplastique



-5°C
+60°C



Cinza | Creme | Preto
Gris | Crema | Negro
Grey | Cream | Black
Gris | Crème | Noir



Atado
Atado
Tied
Attache



VD

EN61386-1

3m

Tubo rígido VD
Tubo VD metrico rígido VD
Metric VD rigid conduit
Conduit rigid IRL



960°C



Ref.	Cod.	Diam. Ext.	Diam. Int. *	Newtons	Cod.	Joules	Cod.	Temp.	Cod.
VD12	3321	12	9,5	750	3	2	3	-5°C +60°C	21
VD16	3321	16	13	750	3	2	3	-5°C +60°C	21
VD16F	4321	16	12	1250	4	2	3	-5°C +60°C	21
VD20	3321	20	17,4	750	3	2	3	-5°C +60°C	21
VD20F	4321	20	16	1250	4	2	3	-5°C +60°C	21
VD25	4321	25	21,6	1250	4	2	3	-5°C +60°C	21
VD32	4321	32	28,4	1250	4	2	3	-5°C +60°C	21
VD40	4321	40	35	1250	4	2	3	-5°C +60°C	21
VD50	4321	50	44	1250	4	2	3	-5°C +60°C	21
VD63	4321	63	56,4	1250	4	2	3	-5°C +60°C	21
VD75	4321	75	68	1250	4	2	3	-5°C +60°C	21
VD90	4321	90	83	1250	4	2	3	-5°C +60°C	21
VD110	4321	110	104	1250	4	2	3	-5°C +60°C	21

* Valor indicativo | Indicative value | Valeur indicative

VD ECO



Creme
Crema
Cream
Crème

3m

Tubo rígido VD ECO
Tubo VD ECO rígido VD
Metric VD rigid ECO conduit
Conduit rigid ECO IRL



Não curva com mola
No doble con la Muelle
Do not bend with spring
Ne pliez pas avec le ressort

960°C



Ref.	Cod.	Diam. Ext.	Diam. Int.	Temp.
VD16ECO	2321	16	13,5	-5°C +60°C
VD20ECO	2321	20	17,4	-5°C +60°C
VD25ECO	2321	25	21,8	-5°C +60°C

* Valor indicativo | Indicative value | Valeur indicative

Baixo teor de fumos
100% isento de chumbo
De acordo com as normas:

Bajo contenido de humos
100% sin plomo
Conforme a las normas:

Low smoke
100% lead free
Standard compliance:

Sans contenu de fumées
100% sans plombe
Conformément aux normes:

EN61386-1
EN61386-21

VD



VD ECO



SCAN + INFO



JSL
Material Eléctrico



Termoplástico
Termoplastico
Thermoplastic
Thermoplastique



-25°C
+90°C



Cinza | Creme | Preto
Gris | Crema | Negro
Grey | Cream | Black
Gris | Crème | Noir



EN61386-23



- Curva a frio com mola até 32
- Hace curvas con muelle en frio hasta 32
- Bends with spring coil at normal temp. until 32
- Pliable a froid avec



SCAN + INFO

Curvas | Bends | Coudes VD



Curvas para tubo rígido VD
Curvas para tubo rígido VD
Bends for rigid VD conduit
Coudes pour conduit rigide VD

Ref.	Para - For - Pour	Dim. (mm)	Temp.
C-16VD	VD 16	16	-25°C +90°C
C-20VD	VD 20	20	-25°C +90°C
C-25VD	VD 25	25	-25°C +90°C
C-32VD	VD 32	32	-25°C +90°C
C-40VD	VD 40	40	-25°C +90°C
C-50VD	VD 50	50	-25°C +90°C

Uniões - Manguitos - Joints - Manchons VD

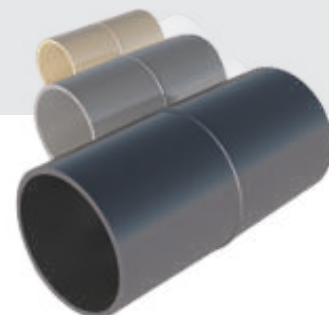

Uniões para tubo rígido VD
Manguitos para tubo rígido VD
Joints for rigid VD conduit
Manchons pour conduit rigide VD

Ref.	Para - For - Pour	Dim. (mm)	Temp.
U406-VD12	VD 12	12	-25°C +90°C
U407-VD16	VD 16	16	-25°C +90°C
U408-VD20	VD 20	20	-25°C +90°C
U409-VD25	VD 25	25	-25°C +90°C
U410-VD32	VD 32	32	-25°C +90°C
U411-VD40	VD 40	40	-25°C +90°C
U412-VD50	VD 50	50	-25°C +90°C
U413-VD63	VD 63	63	-25°C +90°C

Molas - Muelles - Springs - Ressorts - VD IRL

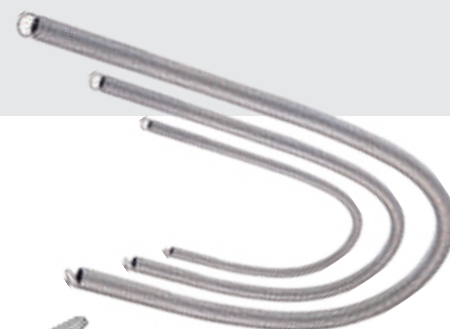

Molas para tubo rígido VD
Muelles para tubo rígido VD
Springs for rigid VD conduit
Ressorts pour conduit rigide VD

Ref.	Para - For - Pour
M012	VD 12
M016	VD 16
M020	VD 20
M025	VD 25
M032	VD 32
M040	VD 40
M050	VD 50
M063	VD 63

VD | FLH



EN61386-1



Termoplástico
Termoplastic
Thermoplastic
Thermoplastique



-25°C
+90°C



Cinza | Preto
Gris | Negro
Grey | Black
Gris | Noir



Atado
Atado
Tied
Attache



Resistência ao esmagamento
Resistencia al aplastamiento
Crush Resistance
Résistance à l'écrasement



Resistência choques mecânicos
Resistencia a golpes mecánicos
Mechanical shocks Resistance
Résistance aux chocs mécaniques

Tubo rígido VD LH
Tubo VD metrico rígido LH
Metric VD HF rigid conduit
Conduit rigid IRL SA



Autoextinguível
Autoextinguible
Self extinguishing
Autoextinguible



Fortes
Fuertes
Heavy loads
Jauge fort



Fortes
Fuertes
Heavy loads
Jauge fort

960°C



Ref.	Cod.	Diam. Ext.	Diam. Int. *	Newtons	Cod.	Joules	Cod.	Temp.	Cod.
VD16FLH	4442	16	12	1250	4	6	4	-25°C +90°C	42
VD20FLH	4442	20	17	1250	4	6	4	-25°C +90°C	42
VD25FLH	4442	25	21,8	1250	4	6	4	-25°C +90°C	42
VD32FLH	4442	32	28,4	1250	4	6	4	-25°C +90°C	42
VD40FLH	4442	40	35	1250	4	6	4	-25°C +90°C	42
VD50FLH	4442	50	44,4	1250	4	6	4	-25°C +90°C	42
VD63FLH	4442	63	57	1250	4	6	4	-25°C +90°C	42

* Valor indicativo | Indicative value | Valeur indicative

VD | MLH



EN61386-1



Tubo rígido VD LH
Tubo VD metrico rígido VD LH
Metric VD HF rigid conduit
Conduit rigid IRL SA



Autoextinguível
Autoextinguible
Self extinguishing
Autoextinguible



Médias
Medias
Medium loads
Jauge Medium



Fortes
Fuertes
Heavy loads
Jauge fort

960°C



Ref.	Cod.	Diam. Ext.	Diam. Int. *	Newtons	Cod.	Joules	Cod.	Temp.	Cod.
VD16MLH	3442	16	13,5	750	3	6	4	-25°C +90°C	42
VD20MLH	3442	20	17,5	750	3	6	4	-25°C +90°C	42
NOVO NEW VD25MLH	3442	25	22,2	750	3	6	4	-25°C +90°C	42

* Valor indicativo | Indicative value | Valeur indicative

VD | LLH



EN61386-1



Tubo rígido VD LH
Tubo VD metrico rígido VD LH
Metric VD HF rigid conduit
Conduit rigid IRL SA



Autoextinguível
Autoextinguible
Self extinguishing
Autoextinguible



Leves
Ligeras
Light loads
Jauge Légères



Fortes
Fuertes
Heavy loads
Jauge fort



Não curva com mola
No doble con la Muelle
Do not bend with spring
Ne pliez pas avec le ressort

960°C



Ref.	Cod.	Diam. Ext.	Diam. Int. *	Newtons	Cod.	Joules	Cod.	Temp.	Cod.
VD16LLH	2442	16	13,8	320	2	6	4	-25°C +90°C	42
VD20LLH	2442	20	17,5	320	2	6	4	-25°C +90°C	42
VD25LLH	2442	25	22,2	320	2	6	4	-25°C +90°C	42
VD32LLH	2442	32	28,8	320	2	6	4	-25°C +90°C	42

* Valor indicativo | Indicative value | Valeur indicative



SCAN + INFO



Termoplástico
Termoplastico
Thermoplastic
Thermoplastique



-25°C
+90°C



Cinza | Creme | Preto | Branco
Grís | Crema | Negro | Blanco
Grey | Cream | Black | White
Grís | Crème | Noir | Blanche

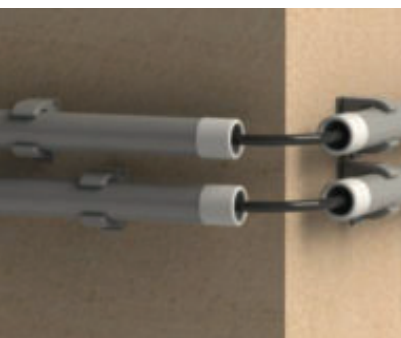

Topos | Terminales | Top Ends VD



Topos para tubo rígido VD e VD LH
Terminales para tubo rígido VD VD LH
Top ends for rigid VD and VD LH conduit
Terminale pour conduit rigide IRL SA

Ref.	Para - For - Pour	Dim. (mm)	Temp.
EC16	VD 16	16	-25°C +90°C
EC20	VD 20	20	-25°C +90°C
EC25	VD 25	25	-25°C +90°C

Uniões | Manguitos | Joints | Manchons VD

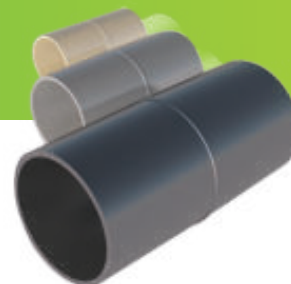

Uniões para tubo rígido VD LH
Manguitos para tubo rígido VD LH
Joints for rigid VD LH conduit
Manchons pour conduit rigide VD SA

Ref.	Para - For - Pour	Dim. (mm)	Temp.
U407-VD16LH	VD 16	16	-25°C +90°C
U408-VD20LH	VD 20	20	-25°C +90°C
U409-VD25LH	VD 25	25	-25°C +90°C
U410-VD32LH	VD 32	32	-25°C +90°C
U411-VD40LH	VD 40	40	-25°C +90°C
U412-VD50LH	VD 50	50	-25°C +90°C
U413-VD63LH	VD 63	63	-25°C +90°C



Curvas | Bends | Coudes VD



Curvas para tubo rígido VD LH
Curvas para tubo rígido VD LH
Bends for rigid VD LH conduit
Coudes pour conduit rigide VD SA

Ref.	Para - For - Pour	Dim. (mm)	Temp.
C-16VDLH	VD 16	16	-25°C +90°C
C-20VDLH	VD 20	20	-25°C +90°C
C-25VDLH	VD 25	25	-25°C +90°C
C-32VDLH	VD 32	32	-25°C +90°C
C-40VDLH	VD 40	40	-25°C +90°C
C-50VDLH	VD 50	50	-25°C +90°C

Boquilhas | Flexible Nipples | Raccords | Flex



Boquilhas para tubo rígido VD e VD LH
Boquillas para tubo rígido VD VD LH
Flexible nipples for VD VD HF conduit
Raccords Flexibles pour conduit rigide IRL SA

Ref.	Para - For - Pour	Dim. (mm)	Temp.
284-VD12	VD 12	12	-25°C +90°C
285-VD16	VD 16	16	-25°C +90°C
286-VD20	VD 20	20	-25°C +90°C
287-VD25	VD 25	25	-25°C +90°C



SCAN + INFO

NOVO
NEW

JSL
Material Eléctrico



100% HALOGEN FREE
TUBO - CONDUITS

VD

HF
HALOGEN FREE

PARA HOSPITAIS, AEROPORTOS, DATA CENTERS, EDIFÍCIOS PÚBLICOS
PARA HOSPITALES, AEROPUERTOS, CENTROS DE DATOS, EDIFICIOS PÚBLICOS
FOR HOSPITALS, AIRPORTS, DATA CENTERS, PUBLIC BUILDINGS



Anelado Retardante de Chama | Corrugado Retardante de Chama
Corrugated Flame Retardant | Annelé Retardateurs de Flamme



Termoplástico
Termoplastico
Thermoplastic
Thermoplastique



-5°C
+90°C



-15°C
+90°C

EN61386-22



Tubo flexível anelado com guia de aço
Livre de halogéneos.
É permitida a instalação em tetos
falsos e parede ocas (ITED 4^{ed})

Tubo corrugado con guia de acero
Libre de halógenos

Corrugated pliable conduit with
steel wire Halogen free

Tube annelé cintrable avec tire-fil
en acier Sans halogènes



Branco
Blanco
White
Blanche



Autoextinguível
Autoextinguible
Self extinguishing
Autoextinguible

EN61386-1
EN61386-22
EN50267-2-2

Ref.	Cod.	Diam. Ext.	Diam. Int. *	Newtons	Cod.	Joules	Cod.	Temp.	Cod.
JSRLH16G	2322	16	11,5	320	2	2	3	-5°C +90°C	22
JSRLH20G	2322	20	14,4	320	2	2	3	-5°C +90°C	22
JSRLH25G	2322	25	18,0	320	2	2	3	-5°C +90°C	22
JSRLH32G	2322	32	25,0	320	2	2	3	-5°C +90°C	22
JSRLH40G	2322	40	31,8	320	2	2	3	-5°C +90°C	22

* Valor indicativo | Indicative value | Valeur indicative

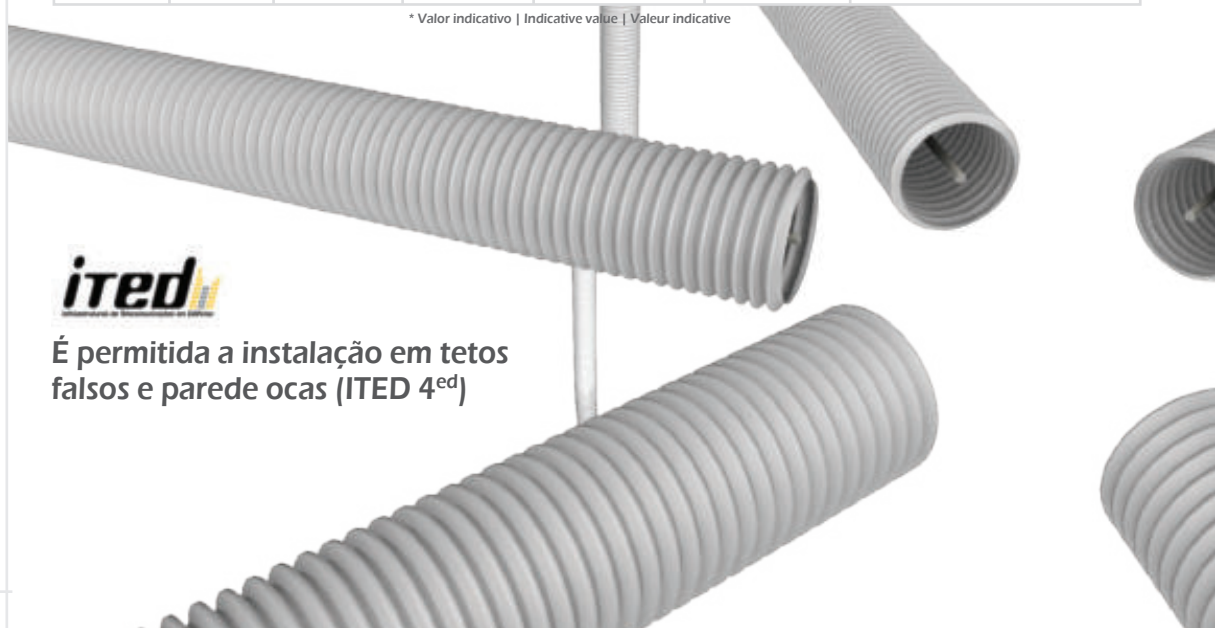

É permitida a instalação em tetos
falsos e parede ocas (ITED 4^{ed})

Anelado | Corrugado | Corrugated | Annelé



Tubo flexível anelado com guia de aço
Livre de halogéneos.

Tubo corrugado con guia de acero
Libre de halógenos

Corrugated pliable conduit with
steel wire Halogen free

Tube annelé cintrable avec tire-fil
en acier Sans halogènes



Cinza
Gris
Grey
Gris



EN61386-1
EN61386-22
EN50267-2-2

Ref.	Cod.	Diam. Ext.	Diam. Int.	Newtons	Cod.	Joules	Cod.	Temp.	Cod.
JS16G	2322	16	11,5	320	2	2	3	-15°C +90°C	22
JS20G	2322	20	14,4	320	2	2	3	-15°C +90°C	22
JS25G	2322	25	18,0	320	2	2	3	-15°C +90°C	22
JS32G	2322	32	25,0	320	2	2	3	-15°C +90°C	22
JS40G	2322	40	31,8	320	2	2	3	-15°C +90°C	22

* Valor indicativo | Indicative value | Valeur indicative



SCAN + INFO



Termoplástico
Termoplastico
Thermoplastic
Thermoplastique



-15°C
+90°C



Cinza
Gris
Grey
Gris



Resistência ao esmagamento
Resistencia al aplastamiento
Crush Resistance
Résistance à l'écrasement



Resistência choques mecânicos
Resistencia a golpes mecánicos
Mechanical shocks Resistance
Résistance aux chocs mécaniques

EN61386-22



ERM



Autoextinguível
Autoextinguible
Self extinguishing
Autoextinguible



Tubo Jotagris "ERM"
Tubo Jotagris "ERM"
Semi-rigid conduit f. concrete
Conduit semi-rigide ICTL
pour le beton



Fortes
Fuertes
Heavy loads
Jauge fort



EN61386-1
EN61386-22
EN50267-2-2

Ref.	Cod.	Diam. Ext.	Diam. Int. *	Newtons	Cod.	Joules	Cod.	Temp.	Cod.
ERM16	4432	16	12	1250	4	6	4	-15°C +90°C	32
ERM20	4432	20	16,2	1250	4	6	4	-15°C +90°C	32
ERM25	4432	25	20,2	1250	4	6	4	-15°C +90°C	32
ERM32	4432	32	25,4	1250	4	6	4	-15°C +90°C	32
ERM40	4432	40	32,5	1250	4	6	4	-15°C +90°C	32

* Valor indicativo | Indicative value | Valeur indicative

ERM Com Guia De Aço | ERM Con Guia De Acero Semi Rigid With Steel Wire | Semi Rigide . Tire-fil En Acier



Autoextinguível
Autoextinguible
Self extinguishing
Autoextinguible



Tubo Jotagris "ERM" com guia de aço
Tubo Jotagris "ERM" con guia de acero
Semi-rigid conduit with steel wire
Conduit semi-rigide ICTL
pour le beton avec tire-fil en acier



Fortes
Fuertes
Heavy loads
Jauge fort



EN61386-1
EN61386-22
EN50267-2-2

Ref.	Cod.	Diam. Ext.	Diam. Int. *	Newtons	Cod.	Joules	Cod.	Temp.	Cod.
ERM16G	4432	16	12	1250	4	6	4	-15°C +90°C	32
ERM20G	4432	20	16,2	1250	4	6	4	-15°C +90°C	32
ERM25G	4432	25	20,2	1250	4	6	4	-15°C +90°C	32
ERM32G	4432	32	25,4	1250	4	6	4	-15°C +90°C	32
ERM40G	4432	40	32,5	1250	4	6	4	-15°C +90°C	32

* Valor indicativo | Indicative value | Valeur indicative

ERFE



Tubo Jotagris "ERFE"
Tubo Jotagris "ERFE"
Semi-rigid conduit f. concrete
Conduit semi-rigide ICTL
pour le beton



Médias
Medias
Medium loads
Jauge Medium



Fortes
Fuertes
Heavy loads
Jauge fort



Ref.	Cod.	Diam. Ext.	Diam. Int. *	Newtons	Cod.	Joules	Cod.	Temp.	Cod.
ERFE16	3432	16	12,4	750	3	6	4	-15°C +90°C	32
ERFE20	3432	20	16,6	750	3	6	4	-15°C +90°C	32
ERFE25	3432	25	20,6	750	3	6	4	-15°C +90°C	32
ERFE32	3432	32	25,9	750	3	6	4	-15°C +90°C	32
ERFE40	3432	40	32,9	750	3	6	4	-15°C +90°C	32

* Valor indicativo | Indicative value | Valeur indicative

ERFE Com Guia De Aço | ERFE Con Guia De Acero Semi Rigid With Steel Wire | Semi Rigide . Tire-fil En Acier



Tubo Jotagris "ERFE" com guia
Tubo Jotagris "ERFE" con guia
Semi-rigid conduit with steel wire
Conduit semi-rigide ICTL
pour le beton avec tire-fil en acier



Médias
Medias
Medium loads
Jauge Medium



Fortes
Fuertes
Heavy loads
Jauge fort



Ref.	Cod.	Diam. Ext.	Diam. Int. *	Newtons	Cod.	Joules	Cod.	Temp.	Cod.
ERFE16G	3432	16	12,4	750	3	6	4	-15°C +90°C	32
ERFE20G	3432	20	16,6	750	3	6	4	-15°C +90°C	32
ERFE25G	3432	25	20,6	750	3	6	4	-15°C +90°C	32
ERFE32G	3432	32	25,9	750	3	6	4	-15°C +90°C	32
ERFE40G	3432	40	32,9	750	3	6	4	-15°C +90°C	32

* Valor indicativo | Indicative value | Valeur indicative



SCAN + INFO

Uniões - Manguitos - Joints - Manchons ERFE / ERM



Termoplástico
Termoplastico
Thermoplastic
Thermoplastique



-15°C
+90°C



Cinza
Gris
Grey
Gris



Resistência ao esmagamento
Resistencia al aplastamiento
Crush Resistance
Résistance à l'écrasement



Resistência choques mecânicos
Resistencia a golpes mecánicos
Mechanical shocks Resistance
Résistance aux chocs mécaniques

Uniões para tubo ERM e ERFE
Manguitos para tubo Jotagris ERM y ERFE
Joints for Jotagris ERM and ERFE conduit/conduit
Manchons pour conduit Jotagris ERM et ERFE



Acções mecânicas fortes
Acciones mecánicas fuertes
Heavy loads
Jauge fort



Ref.	Para - For - Pour	Dim. (mm)	Temp.
U16	ERM - ERFE 16	16	-15°C +90°C
U20	ERM - ERFE 20	20	-15°C +90°C
U25	ERM - ERFE 25	25	-15°C +90°C

Boquilhas - Boquillas - Nipples - Raccords - ERM / ERFE



RoHS



REACH



Boquilhas para tubo Jotagris ERM e ERFE
Boquillas para tubo Jotagris ERM y ERFE
Nipples for Jotagris ERM and ERFE conduit
Raccords pour conduit Jotagris ERM et ERFE

Ref.	Para - For - Pour	Dim. (mm)	Temp.
B16	ERM - ERFE 16	16	-15°C +90°C
B20	ERM - ERFE 20	20	-15°C +90°C
B25	ERM - ERFE 25	25	-15°C +90°C



SCAN + INFO

CÓDIGO DE CLASSIFICAÇÃO PARA TUBOS E ACESSÓRIOS DE ACORDO COM A NORMA NP EN 61386-1
 CÓDIGO DE CLASIFICACIÓN PARA TUBO Y ACCESORIOS CONFORME A LA NORMA UNE EN 61386-1
 CODE OF CLASSIFICATION FOR CONDUITS AND ACCESSORIES ACCORDING TO BS EN 61386-1 STANDARD
 CODE POUR LA CLASSIFICATION DES CONDUITS ET ACCESSOIRES SELON NORME NF EN 61386-1



	1	2	3	4	5	6	7
1º) Resistência à compressão	Muito fraca 125 N em 5 cm	Fraca 320 N em 5 cm	Média 750 N em 5 cm	Forte 1250 N em 5 cm	Muito forte 4000 N em 5 cm	-	-
2º) Resistência ao impacto	Muito fraca 0,5 J	Fraca 1 J	Média 2 J	Forte 6 J	Muito forte 20 J	-	-
3º) Temperatura mínima °C	+5	-5	-15	-25	-45	-	-
4º) Temperatura máxima °C	+60	+90	+105	+120	+150	+250	+400

	1	2	3	4	5	6	7
1º) Resistencia a la compresión	Muy fraca 125 N en 5 cm	Fraca 320 N en 5 cm	Mediana 750 N en 5 cm	Fuerte 1250 N en 5 cm	Muy fuerte 4000 N en 5 cm	-	-
2º) Resistencia al impacto	Muy fraca 0,5 J	Fraca 1 J	Média 2 J	Fuerte 6 J	Muy fuerte 20 J	-	-
3º) Temperatura mínima °C	+5	-5	-15	-25	-45	-	-
4º) Temperatura máxima °C	+60	+90	+105	+120	+150	+250	+400

	1	2	3	4	5	6	7
1º) Compression resistance	Very weak 125 N on 5 cm	Weak 320 N on 5 cm	Medium 750 N on 5 cm	Strong 1250 N on 5 cm	Very strong 4000 N on 5 cm	-	-
2º) Impact resistance	Very weak 0,5 J	Weak 1 J	Medium 2 J	Strong 6 J	Very strong 20 J	-	-
3º) Minimum temperature °C	+5	-5	-15	-25	-45	-	-
4º) Maximum temperature °C	+60	+90	+105	+120	+150	+250	+400

	1	2	3	4	5	6	7
1º) Résistance à l'écrasement	Très faible 125 N en 5 cm	Faible 320 N en 5 cm	Medium 750 N en 5 cm	Forte 1250 N en 5 cm	Très forte 4000 N en 5 cm	-	-
2º) Résistance au choc	Très faible 0,5 J	Faible 1 J	Medium 2 J	Forte 6 J	Très forte 20 J	-	-
3º) Temperature minimum °C	+5	-5	-15	-25	-45	-	-
4º) Temperature maximum °C	+60	+90	+105	+120	+150	+250	+400

Assim || Así || So || Alors

3 3 2 1

1º=3 2º=3 3º=2 4º=1

EXEMPLO 3321 significa: Tubo com média resistência à compressão (3) || Resistência ao impacto de 2 J (3) || Temperatura mínima -5° C (2) || Temperatura máxima de 60° C (1)
 EJEMPLO 3321 indica: Tubo con média resistencia a la compresión (3) || Resistencia al impacto de 2 J (3) || Temperatura mínima -5° C (2) || Temperatura máxima de 60° C (1)
 EXAMPLE 3321 indicates: Conduit with medium compression resistance (3) || Impact resistance up to 2 J (3) || Minimum Temperature -5° C (2) || Maximum temperature + 60° C (1)
 EXEMPLE 3321 veut dire: Tube avec moyenne résistance à la compression (3) || Résistance au choc de 2 J (3) || Temperature -5° C (2) || Temperature maximum de 60° C (1)

ILUMINAÇÃO

Iluminación
Lighting
Éclairage



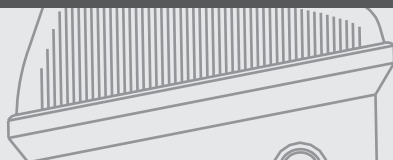

Armaduras estanques | Apliques estancos
Luminaires | Hublots murales étanches



-5°C
+60°C



Termoplástico
Termoplastico
Thermoplastic
Thermoplastique



Lâmpada Incandescente
Lampara Incandescente
Edison Lamp
Lampe Incandescent



Lâmpada LED
Lampara LED
LED Edison Lamp
Lampe LED



Bucim PG
Prensaestopa PG
PG Cable Gland
Presse-étoupe PG



Accepta lâmpadas LED
de temperatura < 36 °C

Accepta lamparas LED
de temperatura < 36 °C

Accepts LED lamps
temperature < 36 °C

Accepte Lampes LED
temperature < 36 °C

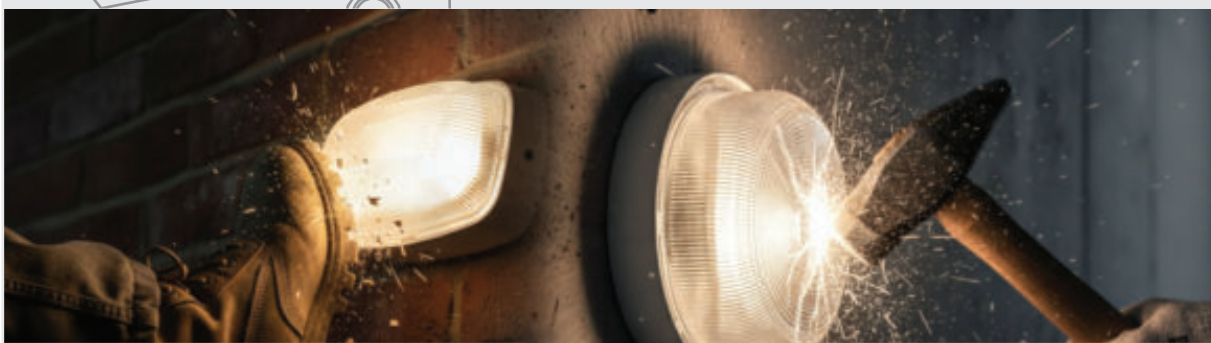
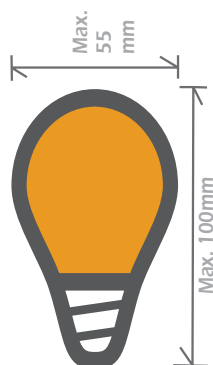

Resistência que ilumina.

Construídas para suportar os ambientes
mais exigentes e impactos extremos.

Resilience that shines.

Built to withstand the toughest
environments and extreme impacts.

460A ^{ref.}

Armadura estanque IP54 (100W)
Luminaria estanca IP54 (100W)
Waterproof light fixture IP54 (100W)
Luminaire étanche IP54 (100W)



IK 09

IP 54



470A ^{ref.}

Armadura estanque IP43 (100W)
Luminaria estanca IP43 (100W)
Weatherproof light fixture IP43 (100W)
Luminaire étanche IP43 (100W)



IK 09

IP 43



471A ^{ref.}

Armadura estanque IP43 (60W)
Luminaria estanca IP43 (60W)
Weatherproof light fixture IP43 (60W)
Luminaire étanche IP43 (60W)



IK 09

IP 43



SCAN + INFO

Ref.	Sup.	Watts	Max T (°C)		IP	IK	Volt.
460	E 27	100 W	36	PG11	54	09	250 V
470	E 27	100 W	45	PG11	43	09	250 V
471	E 27	60 W	36	PG11	43	09	250 V

www.hortelica.pt
SEEING IS BELIEVING
we make sure you do



LIFE OUTDOORS IS FULL OF SURPRISES.
Our robust luminaires ensure you never miss a moment,
NO MATTER HOW SURREAL IT GETS.
Durable, weather-proof, and built to reveal every detail.



JSL
Material Eléctrico

**Reliable and Secure
Server Housings**

ITED

INFRA-ESTRUTURAS DE TELECOMUNICAÇÕES EM EDIFÍCIOS



Armário de telecomunicação da urbanização (ATU)

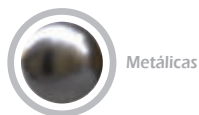

Metálicas



Branco



IP 55



IK 10

Armários construídos em alumínio anti corrosão, tratamento ALUDINE 1200 e de Cor cinza claro RAL 7030.

Resistência a condições climatéricas extremas e ambientes salinos
Protecção de equipamentos sensíveis a perturbações radioeléctricas

Dimensões adequadas para equipamento em formato 19" de acordo com EIA 310D/ DIN 41494/IEC 60297. Aceita todos os tipos de painéis normalizados de 19"

Barramento de terra IP55 de acordo com IEC 60529 IK10



Porta fornecida com Fechadura rotativa e chave



Dupla parede anti condensação
Perfis de rack de 19" ajustáveis em profundidade

Pedestal em aço inox com 100 mm de altura fornecido **grátis**

Paredes laterais desmontáveis para fácil acesso e instalação de equipamento

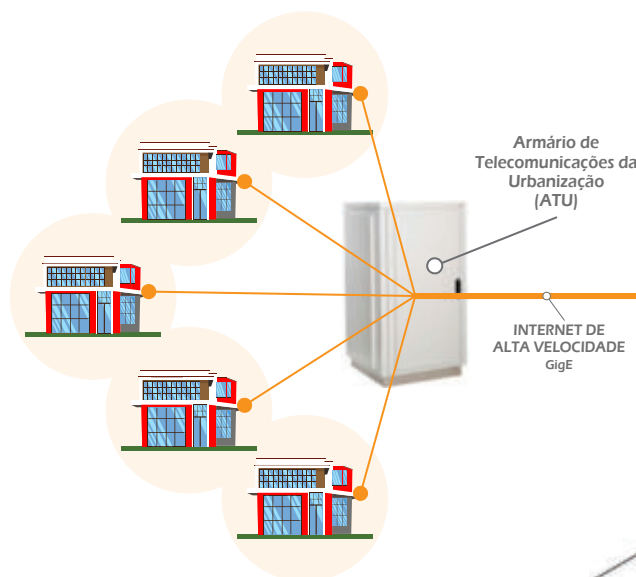

Topo preparado para colocação de ventilação forçada



Grelhas de arrefecimento exteriores para fácil circulação de ar

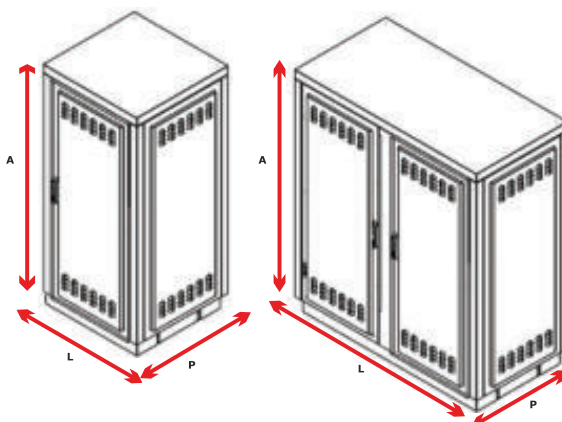

PARA:

Centrais Digitais Telecomunicações
Armários Técnicos de Urbanização -ATU
Estações de Distribuição de Energia
Estações Meteorológicas
Sistemas de Controlo de Dados
Antenas GSM e LTE
Antenas 5G

Ref.	Nº U's	Y (mm)	X (mm)	Z (ext.)/ (Int.)
ATU 23U	23	1135	740	740/540
ATU 2x23U	2x23	1135	1340	740/540



SCAN + INFO

Armários de telecomunicações de edifícios (ATE)

(ITED 2004 1ª Ed.)



Metálicas



Termoplástico



Branco



Ref.	Tipo	Design	IK	IP	Dims.(mm)	Classificação MICE			
						M	I	C	E
Instalação Embebida									
292-ATE2	C2*	Caixa Plástico - ATE2	07	54	400 x 420 x 155	M ²	I ²	C ³	E ¹
Instalação Saliente									
294-ATE2	C2*	Caixa Plástico - ATE2	07	54	400 x 430 x 170	M ²	I ²	C ³	E ¹

*Plástico



RoHS



REACH



HF HALOGEN FREE



Armários de telecomunicações de edifícios (ATE)

(ITED 2010 2ª Ed. & 2014 3ª Ed. & 2020 4ª Ed.)

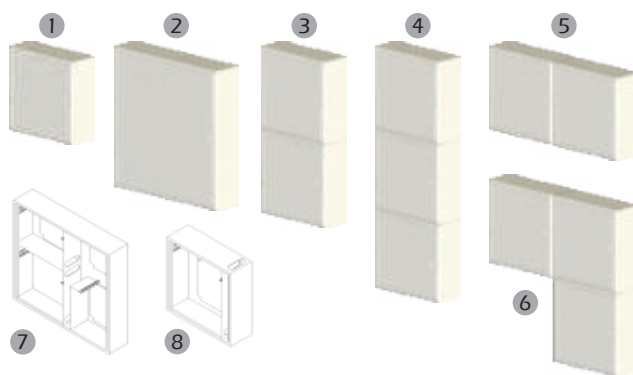

IP 54 IK 09

- 1- ATE modular
- 2- ATE monobloco
- 3- ATEs modulares emparelhados na vertical
- 4- ATEs modulares tecnologias diferenciadas vertical
- 5- ATEs modulares emparelhados
- 6- Arranjo de ATEs modulares FO e PC+CC
- 7- Interior de ATE modular 600x600
- 8- Interior do ATE monobloco 900x1000

- Interligação com as redes públicas de telecomunicações ou com as redes provenientes das ITUR.
- Concentração de redes de telecomunicações do edifício.
- Gestão das diferentes redes de cabos de pares de cobre, coaxiais e de fibra óptica.
- Integração de sistemas de domótica, videoproteiro e sistemas de segurança e redes privadas de TV.
- O ATE faz parte da rede colectiva de tubagens, tem acesso condicionado e é nele que se alojam os Repartidores Gerais (RG) das três tecnologias previstas, designadamente: par de cobre (RG-PC); cabo coaxial (RG-CC) e fibra óptica (RGFO).
- Fabricado em chapa zinco e dupla pintura epoxi em cor branca RAL 9010.
- Os ATEs JSL são fornecidos com placas de fundo de material plástico rígido autoextinguível, com a espessura mínima adequada à fixação de qualquer equipamento.
- Os ATEs estão dotados de espaço interior para receber os compartimentos dos operadores de fibra óptica, recebendo as portas exteriores uma fechadura do tipo RITA (não fornecida).
- O ATE contém o barramento geral de terras das ITED (BGT) e 4 tomadas shucko de alimentação eléctrica.
- Os ATEs poderão ser dotados de janelas de ventilação bastando colocar o ventilador ref. 293MF da JSL.

Ref.	Tipo	Design	IK	IP	Dims.(mm)	Classificação			
						M	I	C	E
Instalação Embebida									
307-ATE-UNI	-	Armário Monobloco	09	54	900 x 1000 x 200	M ³	I ¹	C ¹	E ³
309-ATE-MULTI	-	Multi-Armário	09	54	600 x 600 x 200	M ³	I ¹	C ¹	E ³
Instalação Saliente									
308-ATE-UNI	-	Armário Monobloco	09	54	900 x 1000 x 200	M ³	I ¹	C ¹	E ³
310-ATE-MULTI	-	Multi-Armário	09	54	600 x 600 x 200	M ³	I ¹	C ¹	E ³



SCAN + INFO

Caixas de entrada Multioperador (CAM)

(2020 4ª Ed.)



Termoplástico



Resistência choques mecânicos

Embeber



Salientes



Equipadas com placa de fixação para dispositivo de derivação de PC e de Ligação CC em plástico
(Aceita cassette de "splicers" de fibra ou caixa de fibra JSL ref. RC-FO BOX)

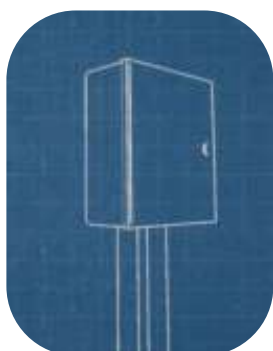

NOTA: De acordo com o manual ITED 2020 4ªed. as caixas deverão ser equipadas com 2 tubos com mínimo de 63 de diâmetro que prolongam a sua face inferior até ao subsolo.

Resistência a Acções Mecânicas Fortes
"ANTI-VANDALISMO"

Fortes



As caixas CAM são equipadas com placas de fundo em material autoextinguível e respectivas ferragens, incluído borne de terra.

Não são fornecidas com suportes dos dispositivos de derivação, nem com os respectivos dispositivos.

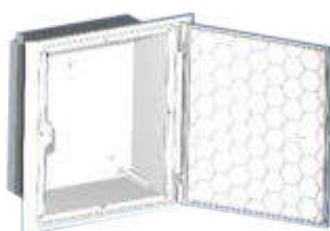
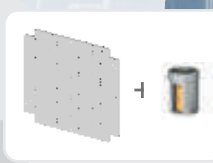

Classificação MICE

Ref.	Tipo	Design	IK	IP	Dims. Int. (mm)	Classificação MICE			
						M	I	C	E
Instalação Embebida									
295-CAM 1	Interior (Embeber)	Caixa CAM 1	09	54	274 x 324 x 125	M ¹	I ¹	C ³	E ¹
296-CAM 2	Interior (Embeber)	Caixa CAM 2	09	54	400 x 420 x 155	M1	I ¹	C ³	E ¹
Instalação Saliente									
297-CAM 1*	Exterior (Saliente)	Caixa CAM 1	09	65	275 x 322 x 185	M ²	I ²	C ³	E ¹
298-CAM 2*	Exterior (Saliente)	Caixa CAM 2	09	54	380 x 422 x 185	M ²	I ²	C ³	E ¹

*As caixas 297-CAM 1 e 298-CAM 2, são fornecidas já com 2 fechaduras metálicas anti-corrosão e com chave

RC-FO BOX

Para fazer o link entre a rede da coluna montante ou ATE e a rede Individual do assinante. Equipada com 4 adaptadores SCAPC Simplex, manga de protecção, abraçadeiras, buchas de fixação e 4 "splicers" para protecção dos empalmes em caso de realização de fusões. Pode ser utilizado como ponto de distribuição de Fibra óptica em remodelações da habitação ou escritórios (recebe até 4 fibras)



Dimensão (mm): 150x109x32

Ref.	Dims. (mm)	SC-APC Adap
RC-FO	150 x 109 x 32	4



SCAN + INFO



Caixas de coluna da rede colectiva Embebida / Saliente (Tipo C)



Metálicas
Metal
Métal



Termoplástico
Termoplastic
Thermoplastic
Thermoplastique



Branco

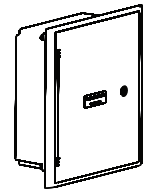
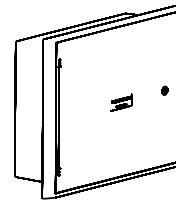
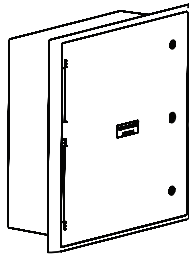
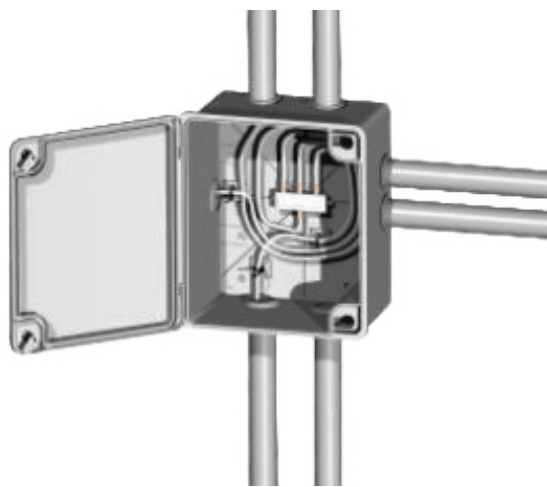

Classificação MICE

Ref.	Tipo	Design	IK	IP	Dim. Int. (mm)	M	I	C	E
Instalação Embebida									
226-C0	C0*	Caixa Plástico	09	65	220 x 170 x 105	M ²	I ²	C ³	E ¹
291-C1	C1*	Caixa Plástico	09	54	274 x 324 x 125	M ²	I ²	C ³	E ¹
292-C2	C2*	Caixa Plástico	09	54	400 x 420 x 155	M ²	I ²	C ³	E ¹
Instalação Saliente									
226-C0	C0*	Caixa Plástico	09	65	220 x 170 x 105	M ²	I ²	C ³	E ¹
293-C1	C1*	Caixa Plástico	09	65	275 x 322 x 185	M ²	I ²	C ³	E ¹
294-C2	C2*	Caixa Plástico	09	54	380 x 422 x 185	M ²	I ²	C ³	E ¹

*Plástico

Instalação Embebida
Instalación empotrada
Flush mounting installation
Installation encastré



Instalação Exterior
Instalación superficie
Surface mounting
Installation surface

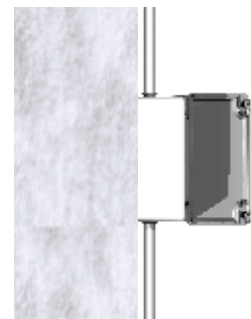

SCAN + INFO

PORMENORES CONSTRUTIVOS E DIMENSIONAIS
CAIXAS TIPO 'C' e ATE's

(Dimensões em mm)



C1 E C2 - INSTALAÇÃO EMBEBIDA

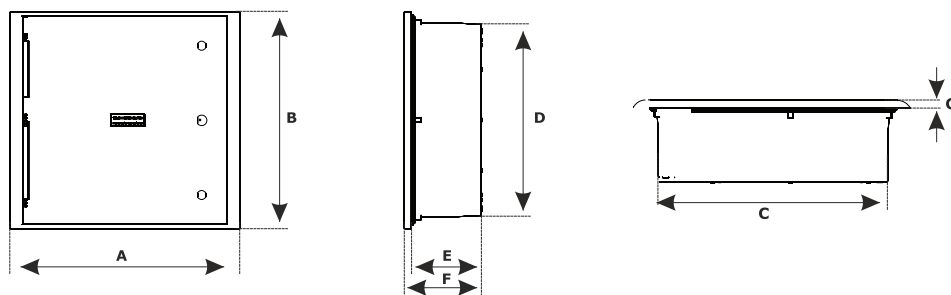

Tipo	A	B	C	D	E	F	G
C1	350	362	256	302	123	133	10
C2	510	480	405	428	155	171	16

C1 E C2 - INSTALAÇÃO SALIENTE

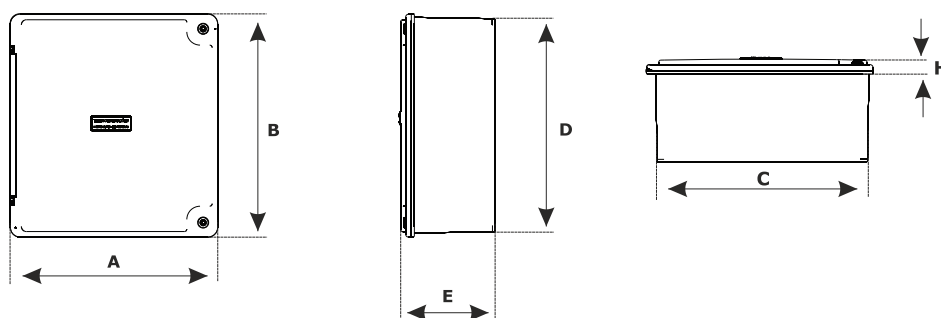

Tipo	A	B	C	D	E	H
C1	300	345	278	330	190	30
C2	410	440	385	424	190	30

INSTALAÇÃO EMBEBIDA E SALIENTE C3, C4, C5, C6 E C7

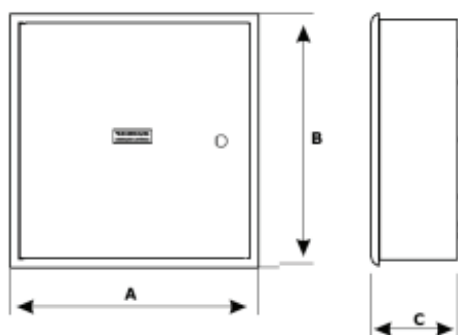

Tipo	A	B	C
C3	500	600	160
C4	700	900	160
C5	830	900	200
C6	830	1070	200
C7	830	1240	200

PLACA DE FUNDO C1 E PLACA C2

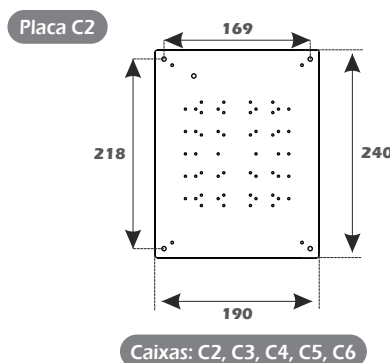
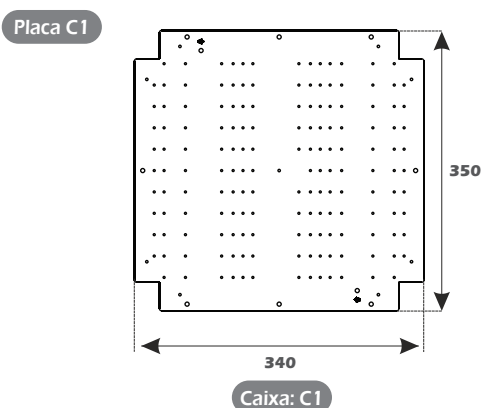

Armário de Telecomunicações individuais (ATI) - Fundo Grande



Termoplástico



Branco



RoHS



REACH



HF
HALOGEN FREE



ATIKIT^{GN} 971 ITED² ITED³ ITED⁴

Composto por: Painel + Moldura + Tampa

ATI com espaço extra para equipamentos activos (ONT e Switch) num só corpo (5dm³ disponível)

Com tomada de energia e barramento terra incluídos
Com placa electrónica CAT.6 (Classe E)

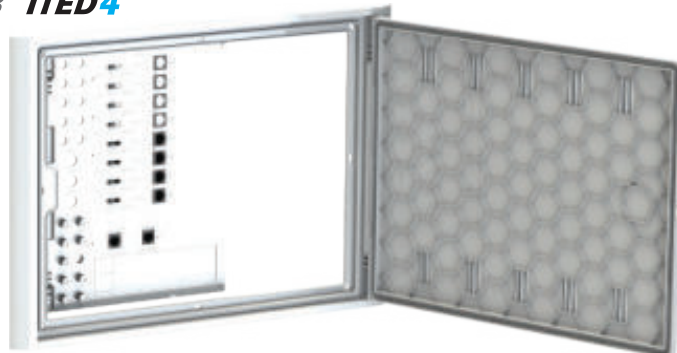

Ref.	Design	Dims.(mm)	RC-PC N.º TT PC	RC-CC N.º TT CC	RC-FO N.º TT FO
K971GR - 4	ATI KIT	360x504x125	4	4	2
K971GR - 6	ATI KIT	360x504x125	6	6	2
K971GR - 8	ATI KIT	360x504x125	8	8	2

Fundo para pré-instalação grande

Ref.	Design	Dims.(mm)
71GN	Fundo ATI 10-16 saídas	360x504x123



ATICOMP^{GN} 971 ITED² ITED³ ITED⁴

Composto por: Fundo 71GN + Painel ATI + Moldura + Tampa



ATI com espaço extra para equipamentos activos (ONT e Switch) num só corpo (5dm³ disponível)

Com tomada de energia e barramento terra incluídos
Com placa electrónica CAT.6 (Classe E)



Ref.	Design	Dims.(mm)	RC-PC N.º TT PC	RC-CC N.º TT CC	RC-FO N.º TT FO
C971GR - 4	ATI COMPLETO	360x504x125	4	4	2
C971GR - 6	ATI COMPLETO	360x504x125	6	6	2
C971GR - 8	ATI COMPLETO	360x504x125	8	8	2

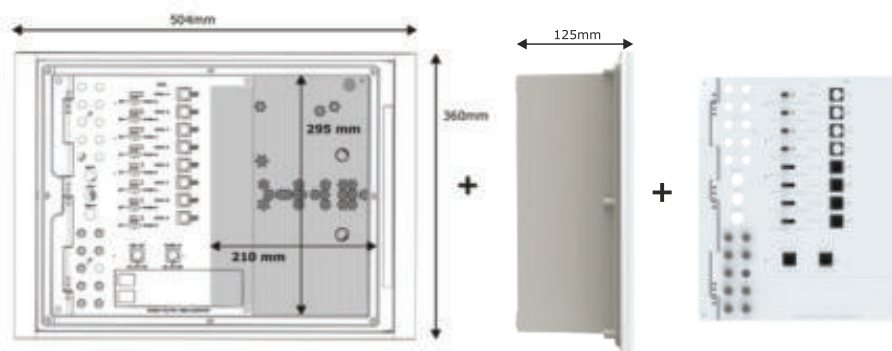

Com placa electrónica CAT.6 (Classe E)



SCAN + INFO



Termoplástico



Branco



ATIKIT^G 671 ITED2 ITED3 ITED4

Composto por: Painel + Moldura + Tampa

ATI com espaço extra para equipamentos activos (ONT e Switch) num só corpo

Necessita de / ou deve ser acoplada uma caixa CATI-P ou CATI-G para equipamento activo

Com tomada de energia e barramento terra incluídos
Com placa electrónica CAT.6 (Classe E)



Ref.	Design	Dims.(mm)	RC-PC N.º TT PC	RC-CC N.º TT CC	RC-FO N.º TT FO
K671GR-4	ATI KIT	360X504X125	4	3 SMATT + 3 CATV	2
K671GR-6	ATI KIT	360X504X125	6	4 SMATT + 4 CATV	2
K671GR-8	ATI KIT	360X504X125	8	6 SMATT + 6 CATV	2
K671GR-10	ATI KIT	360X504X125	10	6 SMATT + 6 CATV	2
K671GR-12	ATI KIT	360X504X125	12	8 SMATT + 8 CATV	2
K671GR-14	ATI KIT	360X504X125	14	8 SMATT + 8 CATV	2
K671GR-16	ATI KIT	360X504X125	16	8 SMATT + 8 CATV	2

Fundo para pré-instalação grande

Ref.	Design	Dims.(mm)
71G	Fundo ATI 10-16 saídas	360x504x123



ATICOMP^G 671 ITED2 ITED3

Composto por: Fundo 71G + Painel ATI + Moldura + Tampa



ATI com espaço extra para equipamentos activos (ONT e Switch) num só corpo

Necessita de / ou deve ser acoplada uma caixa CATI-P ou CATI-G para equipamento activo

Com tomada de energia e barramento terra incluídos
Com placa electrónica CAT.6 (Classe E)

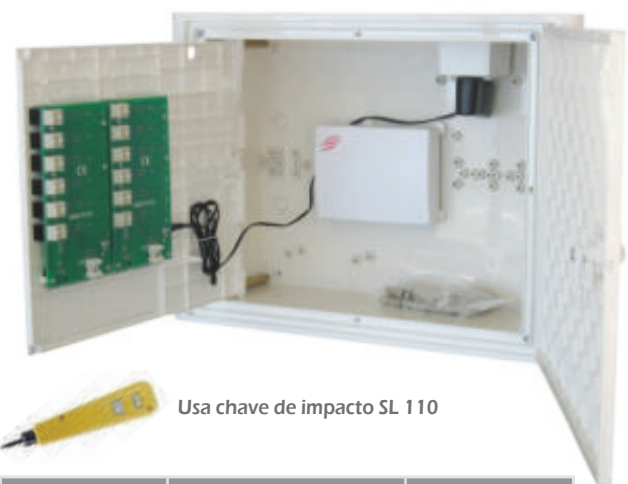

Usa chave de impacto SL 110

Ref.	Design	Dims.(mm)	RC-PC N.º TT PC	RC-CC N.º TT CC	RC-FO N.º TT FO
C671GR-4	ATI COMPLETO	360X504X125	4	3 SMATT + 3 CATV	2
C671GR-6	ATI COMPLETO	360X504X125	6	4 SMATT + 4 CATV	2
C671GR-8	ATI COMPLETO	360X504X125	8	6 SMATT + 6 CATV	2
C671GR-10	ATI COMPLETO	360X504X125	10	6 SMATT + 6 CATV	2
C671GR-12	ATI COMPLETO	360X504X125	12	8 SMATT + 8 CATV	2
C671GR-14	ATI COMPLETO	360X504X125	14	8 SMATT + 8 CATV	2
C671GR-16	ATI COMPLETO	360X504X125	16	8 SMATT + 8 CATV	2



SCAN + INFO

Armário de Telecomunicações individuais (ATI) - Fundo Pequeno



Termoplástico



Branco



ATIKIT^P 971 ITED2 ITED3 ITED4

Composto por: Painel + Moldura + Tampa

Compactos para usar com Caixa de apoio CATI-P

Necessita de / ou deve ser acoplada uma caixa CATI-P para equipamento activo

Com tomada de energia e barramento terra incluídos
Com placa electrónica CAT.6 (Classe E)

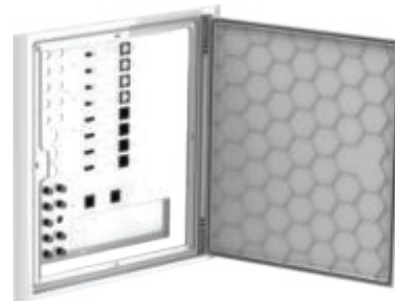

Ref.	Design	Dims.(mm)	RC-PC N.º TT PC	RC-CC N.º TT CC	RC-FO N.º TT FO
K971PR - 4	ATI KIT	360x350x123	4	4	2
K971PR - 6	ATI KIT	360x350x123	6	6	2
K971PR - 8	ATI KIT	360x350x123	8	8	2

Fundo para pré-instalação pequeno

Ref.	Design	Dims.(mm)
71P	Fundo ATI 4-8 saídas	274x324x123



ATICOMP^P 971 ITED2 ITED3 ITED4

Composto por: Fundo 71P + Painel ATI + Moldura + Tampa



Compactos para usar com Caixa de apoio CATI-P

Necessita de / ou deve ser acoplada uma caixa CATI-P para equipamento activo

Com tomada de energia e barramento terra incluídos
Com placa electrónica CAT.6 (Classe E)



Ref.	Design	Dims.(mm)	RC-PC N.º TT PC	RC-CC N.º TT CC	RC-FO N.º TT FO
C971PR - 4	ATI COMPLETO	360x350x123	4	4	2
C971PR - 6	ATI COMPLETO	360x350x123	6	6	2
C971PR - 8	ATI COMPLETO	360x350x123	8	8	2

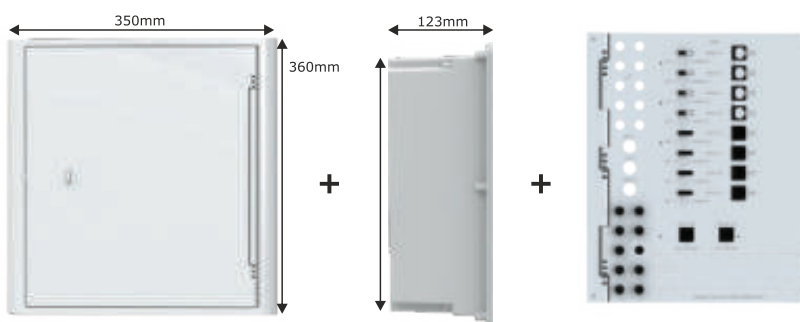

Com placa electrónica CAT.6 (Classe E)



SCAN + INFO



Termoplástico



Branco



RoHS



REACH



HF HALOGEN FREE



ATICOMP S₆₇₁ ITED2 ITED3

Composto por: Caixa completa + Painel

- Caixa estanque saliente IP65
- Elevada resistência no impacto IK-08
- 3 tecnologias de telecomunicações PC, CC e FO
- CAT 6 (classe G) - Actualizável até CAT 6A

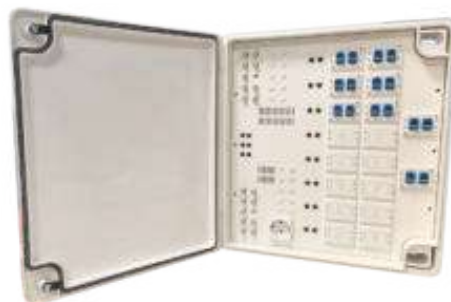

Ref.	Design	Dims.(mm)	IP	IK	RC-PC N.º TT PC	RC-CC N.º TT CC	RC-FO N.º TT FO
S671G - 4	ATI COMPLETO	300X402X190	65	08	4	4	2
S671G - 6	ATI COMPLETO	300X402X190	65	08	6	6	2
S671G - 8	ATI COMPLETO	300X402X190	65	08	8	8	2
S671G - 10	ATI COMPLETO	300X402X190	65	08	10	12	2
S671G - 12	ATI COMPLETO	300X402X190	65	08	12	12	2
S671G - 14	ATI COMPLETO	300X402X190	65	08	14	16	2
S671G - 16	ATI COMPLETO	300X402X190	65	08	16	16	2

CATI - Caixa de apoio de apoio ao ATI (Instalação Embebida)

CATI ITED2 ITED3

Composto por: Caixa completa

Instalação com ATI na horizontal ou vertical.

- Recebe o ONT, switch e outros equipamentos activos
- Amplo volume disponível para 'Patching' e cablagem e interligação com o ATI



CATI-P



CATI-G



COMPOSIÇÃO CATI-P + ATI

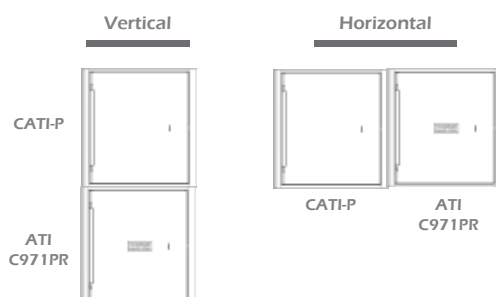

COMPOSIÇÃO CATI-G + ATI

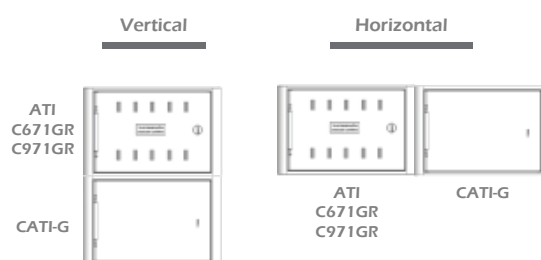

Ref.	Design	Dims.(mm)
CATI-P	Caixa apoio ao ATI	360x350x123
CATI-G	Caixa apoio ao ATI	360X504X125



SCAN + INFO

FIBRA OPTICA MONOMODO OS2 ITU-T G 657 CLASSE A Pré-conectorizados SC-APC / SC-APC



Macrobending Loss (Perdas por curvatura) em conformidade com ITU-T G.657 CLASSE A. (Elevada imunidade à curvatura)

Atenuações: 1310 nm < 0.36 dB/Km : 1550 nm < 0.3 dB/Km, Return Loss >65 dBs

Fibra monomodo OS 2, Livre de halogéneos e com excelentes propriedades retardantes de chama e baixa libertação de Fumos (LSZH): Invólucro de 3mm diametro e revestimento interior com fibras de ARAMID de alta resistência à traccão.

Cabos pré-conectorizados com Perdas Totais inferiores a 0.65 dBs.

Cabos com dimensões versáteis para todo o tipo de instalações e edifícios: 1,5 mts, 12 mts, 18 mts, 24 mts e 32 mts.



Revestimento exterior de 3 mm

Fibra monomodo OS 2

Lado do ATE ou ATI



Lado do enfiamento para o ATI ou para a ZAP

Revestimento protector da fibra 900 µm



Ref.	Design	Dims.(mts)
PGT015SM09	Pigtail SM OS2 ITU-T G.657 CLASSE A LSZH SC/APC Simplex (0.9 mm diam. Ext.)	1.5 mt
PAC015SM20	Patchcord SM OS2 ITU-T G.657 CLASSE A LSZH SC/APC-SC/APC Simplex (2.0 mm diam. Ext.)	1.5 mt
PAC015SM30	Patchcord SM OS2 ITU-T G.657 CLASSE A LSZH SC/APC-SC/APC Duplex (3.0 mm diam. Ext.)	1.5 mt
PAC120SM30	Patchcord SM OS2 ITU-T G.657 CLASSE A LSZH SC/APC-SC/APC Duplex (3.0 mm diam. Ext.)	12 mt
PAC180SM30	Patchcord SM OS2 ITU-T G.657 CLASSE A LSZH SC/APC-SC/APC Duplex (3.0 mm diam. Ext.)	18 mt
PAC240SM30	Patchcord SM OS2 ITU-T G.657 CLASSE A LSZH SC/APC-SC/APC Duplex (3.0 mm diam. Ext.)	24 mt
PAC320SM30	Patchcord SM OS2 ITU-T G.657 CLASSE A LSZH SC/APC-SC/APC Duplex (3.0 mm diam. Ext.)	32 mt

Outras dimensões de cabos pré-conectorizados de fibra óptica, favor consultar.

Otras dimensiones de cables de fibra óptica pre - conectorizados , por favor póngase en contacto con nosotros.

Other dimensions of pre - connectorized fiber optic cables , please contact us.

Autres dimensions de câbles de fibre optique pré - connectorisés , se il vous plaît contactez-nous .



SCAN + INFO

MORE THAN 60 YEARS OF STRONG CONNECTIONS



Thank You!

JSL
Material Eléctrico

BASTIDORES

Bastidores
Cabinets
Armoires

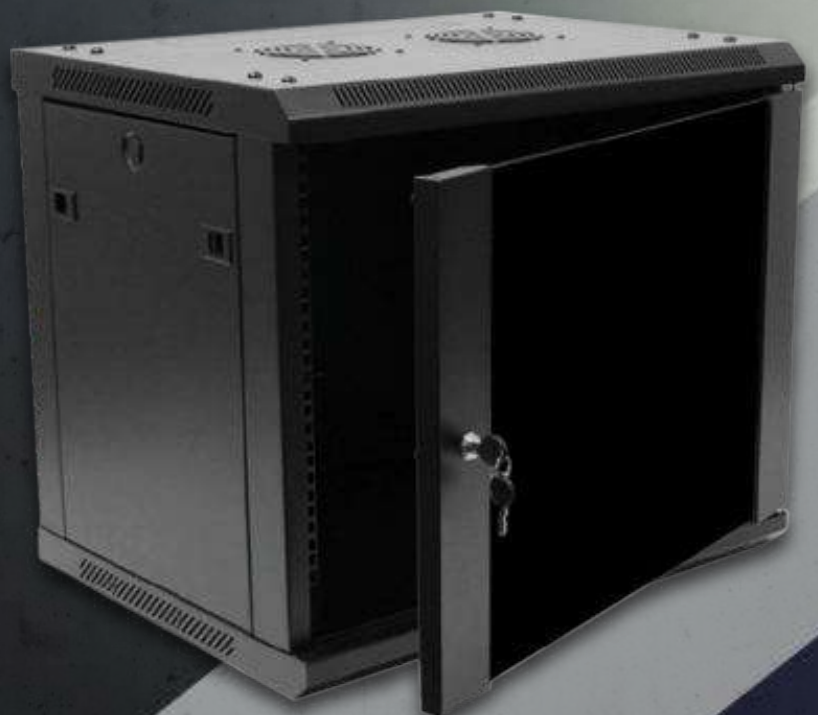

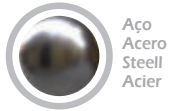

Aço
Acero
Steel
Acier



Preto
Negro
Black
Noir



Bastidores de parede mono corpo e duplo corpo
Bastidores murales mono cuerpo y doble cuerpo
Single and double body wall network cabinets
Coffret réseau mono corps et double corps



- Armários bastidores metálicos de parede fornecidos já completamente montados.
- Fixação interior anti-roubo com 4 furos para montagem na parede de modo a facilitar a instalação.
- Dimensões disponíveis: 600x450mm (monocorpo) e 600x550mm (duplo corpo).
- Bastidores de parede monocorpo na versão de 6U, 9U, 12U e 15U.
- Bastidores de parede de duplo corpo na versão de 6U, 9U e 15U.
- Já equipados com 1 prateleira nos modelos de 12U e 15U.
- Capacidade de carga: 100 kg
- Já equipados com Fans de ventilação: 1 ventilador nos modelos de 6U e 9U, 2 ventiladores nos modelos de 12U e 15U.
- Porta frontal em vidro temperado e com fechadura
- Painéis laterais amovíveis e com fechadura incluída.
- Em conformidade com as normas internacionais DIN41491, (/ EIA ANSI) RS-310-D - DIN41494 - IEC / IEC 297-1 / 2 - IEC / IEC 917-2-7 de definição de sistema de rack padrão (19" = 482,6 milímetros) (1U = 44,45mm)

- Bastidores murales metálicos suministrados completamente ensamblados y montados.
- Fijación interna anti-roboto y con 4 agujeros para facilitar la instalación en la pared.
- Dimensiones disponibles: 600x450mm (mono cuerpo) y 600x550mm (doble cuerpo).
- Rack mural mono cuerpo en versión 6U, 9U, 12U y 15U.
- Rack mural doble cuerpo en versión de 6U, 9U y 15U.
- Ya equipado con 1 bandeja fija en los modelos 12U y 15U.
- Capacidad de carga: 100 kg
- Ya equipadas con Fans de ventilación: 1 ventilador en modelos de 6U y 9U, 2 ventiladores en los modelos de 12U y 15U.
- Puerta frontal de cristal templado y cerradura
- Paneles laterales desmontables y con cerradura incluida.
- En conformidad con las normas internacionales DIN41491, (/ EIA ANSI) RS-310-D - DIN41494 - CEI / IEC 297-1 / 2 - IEC / IEC 917-2-7 de definición del sistema de rack estándar (19" = 482,6 mm) (1U = 44,45mm)

- 19-Inch wall network cabinets made of metal and supplied already fully assembled.
- Anti-theft inner fixation with 4 holes to facilitate the installation in wall surface mounting.
- Dimensions available: 600x450mm (Single body) and 600x550mm (double body).
- Single body wall cabinets in versions of 6U, 9U, 12U and 15U.
- Double body wall cabinets in versions of 6U, 9U and 15U.
- Already equipped with 1 shelf in 12U and 15U models.
- Load capacity: 100 kg
- Already equipped with ventilation Fans: 1 fan in 6U and 9U models, 2 fans in 12U and 15U models.
- Front door in tempered glass and lockable
- Removable side panels with lock included.
- In accordance with international standards DIN41491, (/ EIA ANSI) RS-310-D - DIN41494 - IEC / IEC 297-1 / 2 - IEC / IEC 917-2-7, defining and settings the 19 inches rack system (19"= 482,6 mm) (1U = 44,45mm)

- Armoires coffrets réseau métalliques livrés déjà entièrement assemblées.
- Fixation intérieure antivol, avec 4 Trous de fixation murale prévus pour une pose facilité
- Dimensions disponibles: 600x450mm (mono corps) et 600x550mm (double corps).
- Coffrets réseau mono corps en version 6U, 9U, 12U et 15U.
- Coffrets réseau double corps en version de 6U, 9U et 15U.
- Modèles de 12U et 15U déjà équipées de une tablette fixe.
- Capacité de charge: 100 kg
- Déjà équipées de fans de ventilation: une fan dans les modèles de 6U et 9U, deux ventilateurs dans les modèles 12U et 15U.
- Porte avant en verre sécurité trempé et verrouillable
- Panneaux latéraux amovibles avec fermeture à clé inclus
- Conformément aux normes internationales DIN41491, (/ EIA ANSI) RS-310-D - DIN41494 - CEI / IEC 297-1 / 2 - CEI / IEC 917-2-7 de définition du système de rack standard 19" (= 482,6 mm) (1U = 44,45mm)



SCAN + INFO

Ref.	Design	Dims.(mm)
MONOCORPO / DOBLE CUERPO / SINGLE BODY / MONOCORPS		
B-05FF-6U	Bastidor - Cabinet - Coffret : 6U (600 x 450)	600x450x368
B-05FF-9U	Bastidor - Cabinet - Coffret : 9U (600 x 450)	600x450x501
B-05FF-12U	Bastidor - Cabinet - Coffret : 12U (600 x 450)	600x450x635
B-05FF-15U	Bastidor - Cabinet - Coffret : 15U (600 x 450)	600x450x769
DUPLO CORPO / DOBLE CUERPO / DOUBLE BODY / DOUBLE CORPS		
B-02BC-6U	Bastidor - Cabinet - Coffret : 6U (600 x 550)	600x550x368
B-02BC-9U	Bastidor - Cabinet - Coffret : 9U (600 x 550)	600x550x501
B-02BC-15U	Bastidor - Cabinet - Coffret : 15U (600 x 550)	600x550x769



Aço
Acero
Steeel
Acier



Preto
Negro
Black
Noir



Bastidores de chão Bastidor de piso Free standing floor cabinet Armoire tech. Baie de brassage

- Armários bastidores metálicos de chão de 16U, 18U, 22U, 32U, 42U e 47Us, fornecidos já completamente montados.
- Fornecidos com 4 rodízios montados (2 com travão) e conjunto de 4 pés de apoio anti-vibração.
- Já equipados com prateleiras de acordo com o tamanho do bastidor: 1 prateleiras nos modelos de 16U e 18Us, 2 prateleiras nos modelos de 22U e 32Us, 3 prateleiras nos modelos de 42U e 47Us.
- Dupla ventilação superior incluída: 2 Fans de ventilação nos bastidores de 16U, 18U e 22Us, 4 Fans de ventilação nos bastidores de 32U, 42U e 47Us.
- Porta frontal em vidro temperado e com fechadura. Porta traseira em metal também com fechadura.
- Carga máxima admissível: 800 Kg

- Gabinetes Bastidores de piso, en metal de 16U, 18U, 22U, 32U, 42U e 47Us, y suministrados completamente ensamblados y montados.
- Se suministran con 4 ruedas montados (2 con freno) y un conjunto de 4 pies de soporte anti vibración.
- Ya equipados con 2 bandejas fijas en los modelos 16U, 18U, 22U y 32Us y equipados con 3 bandejas fijas en los modelos de 42U y 47Us.
- Ya equipados con Fans de ventilación: 2 ventiladores en modelos de 16U, 18U y 22Us, 4 ventiladores en los modelos de 32U, 42U y 47Us.
- Puerta frontal de cristal templado y cerradura. Puerta posterior en metal y con cerradura.
- Carga máxima permitida: 800 Kg

- 19-Inch free-standing floor network cabinets 16U, 18U, 22U, 32U, 42U and 47Us, made of metal and supplied already fully assembled.
- Supplied with 4 castors (2 with brake) and set of 4 anti-vibration leveling feet.
- Already equipped with shelves according to the size of the cabinet: 1 shelf in 16U and 18US models, 2 shelves in 22U and 32Us and 3 shelves in 42U and 47Us cabinets.
- Already equipped with double top ventilation: 2 Fans ventilation in the 16U, 18U and 22Us models, 4 Fans ventilation in the 32U, 42U and 47Us models.
- Front door in tempered glass and lockable. Rear door in metal with lock.
- Maximum allowable load: 800 Kg

- Baie de Brassage en métal de 16U, 18U, 22U, 32U, 42U et 47Us, livrés déjà entièrement assemblées.
- Livrées avec 4 roulettes (2 avec frein) et un ensemble de quatre pieds nivellement réglables en hauteur et anti-vibration.
- Équipées des tablettes fixes ; 2 tablettes fixes dans les modèles de 16U, 18U, 22U et 32Us, 3 tablettes dans les modèles de 42U et 47Us.
- Déjà équipées de fans de ventilation: 2 fans de ventilation dans les modèles de 16U, 18U, et 22Us et 4 ventilateurs dans les modèles 32U, 42U et 47U.
- Porte avant en verre sécurité trempé et verrouillable. Porte avant démontable.
- Charge maximale autorisée: 800 Kg



Em conformidade com as normas internacionais DIN41491, (/ EIA ANSI) RS-310-D - DIN41494 - IEC / IEC 297-1 / 2 - EC / IEC 917-2-7 de definição de sistema de rack padrão (19"= 482,6 milímetros)(1U = 44,45mm)

En conformidad con las normas internacionales DIN41491, (/ EIA ANSI) RS-310-D - DIN41494 - CEI / IEC 297-1 / 2 - IEC / IEC 917-2-7 de definición del sistema de rack estándar (19"= 482.6 mm) (1U = 44,45mm)

In accordance with international standards DIN41491, (/ EIA ANSI) RS-310-D - DIN41494 - IEC / IEC 297-1 / 2 - IEC / IEC 917-2-7, defining the settings and requirements for 19 inches rack system (19"= 482.6 mm) (1U = 44,45mm)

Conformément aux normes internationales DIN41491, (/ EIA ANSI) RS-310-D - DIN41494 - CEI / IEC 297-1 / 2 - CEI / IEC 917-2-7 de définition du système de rack standard 19 "(= 482,6 mm) (1U = 44,45mm)



SCAN + INFO

Ref.	Design	Dims.(mm)	Qt.
B-05A-16U	Bastidor - Cabinet - Baie : 16U (600 x 600)	600x600x943	1
B-05A-18U	Bastidor - Cabinet - Baie : 18U (600 x 600)	600x600x988	1
B-05A-22U	Bastidor - Cabinet - Baie : 22U (600 x 600)	600x600x1166	1
B-05A-32U	Bastidor - Cabinet - Baie : 32U (600 x 600)	600x600x1610	1
B-05A-42U	Bastidor - Cabinet - Baie : 42U (600 x 600)	600x600x2055	1
B-068-42U	Bastidor - Cabinet - Baie : 42U (600 x 800)	600x800x2055	1
B-610-42U	Bastidor - Cabinet - Baie : 42U (600 x 1000)	600x1000x2055	1
B-088-42U	Bastidor - Cabinet - Baie : 42U (800 x 800)	800x800x2055	1
B-068-47U	Bastidor - Cabinet - Baie : 47U (600 x 800)	600x800x2277	1
B-610-47U	Bastidor - Cabinet - Baie : 47U (600 x 1000)	600x1000x2277	1

Acessórios para bastidores 19 POL.
 Paneles y accesorios para bastidores 19 PUL.
 Panels and accessories for 19" cabinets
 Panneaux et accessoires coffret bay pour les armoires 19 Pouces



Aço
Acero
Stéell
Acier



Preto
Negro
Black
Noir



B-J001 ref.



Placa de Fundo perfurada 1U
 Panel posterior perforador para gestión de cables 1U
 Cable management rear Panel 1U
 Panneau arrière de gestion de câbles 1U

B-J002 ref.



Placa de Fundo perfurada 2U
 Panel posterior perforador para gestión de cables 2U
 Cable management rear Panel 2U
 Panneau arrière de gestion de câbles 2U

B-J003 ref.



Placa de Fundo perfurada 3U
 Panel posterior perforador para gestión de cables 3U
 Cable management rear Panel 3U
 Panneau arrière de gestion de câbles 3U

B-J004 ref.



Placa Passa Cabos 1UA alto (standard)
 Panel pasacables 1UA más elevado (normal)
 Cable management Panel 1UA high depth (normal)
 Panneau gestion de câbles 1UA grandt taille (normal)

B-J005 ref.



Placa Passa Cabos 1UB baixo (para bastidores de parede)
 Panel pasacables 1UB bajo(para bastidores murales)
 Cable management Panel 1UB low depth (for wall cabinets)
 Panneau gestion de câbles 1UB petit taille (pour armoire coffret)

B-J006 ref.



Placa de Fundo perfurada 1U
 Panel posterior perforador para gestión de cables 1U
 Cable management rear Panel 1U
 Panneau arrière de gestion de câbles 1U

B-J007 ref.



Placa de escovas passa cabos 1U
 Pasacables de cepillo 1U
 Brush panel 1U
 Panneau passe-câbles à brosse 1U

B-J013 ref.



Conjunto Parafuso Anilha com Porca para fixação painéis U
 Tornillo, Arandela y Tuerca de fijación de Paneles U
 Screw, Washer and Nut for U Panels fixing
 Vis, Rondelle et Ecrou pour la fixation des Panneaux U

B-J015 ref.



Gaveta Cantilever Amovível com Guias para bastidor de chão e parede
 Bandeja telescópica para racks
 Telescopic pull out Keyboard tray with rails
 Tablette télescopique - Baie

B-J017-1U ref.



Prateleira 1U fixação frontal
 Bandeja fija (fijación frontal) 1U
 Fixed tray 1U (frontal fixing)
 Tablette fixe 1U -fixation frontale

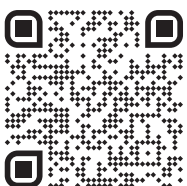

SCAN + INFO



Aço
Acero
Steel
Acier



Preto
Negro
Black
Noir



B-J017-2U ref.



Prateleira 2U fixação frontal
Bandeja fija (fijación frontal) 2U
Fixed tray 2U (frontal fixing)
Tablette fixe 2U -fixation frontale

B-J019-1U ref.



Painéis Cegos 1U
Panel ciego 1U
Blank Panel 1U
Panneau plein 1U

B-J019-2U ref.



Painéis Cegos 2U
Panel ciego 2U
Blank Panel 2U
Panneau plein 2U

B-J019-3U ref.



Painéis Cegos 3U
Panel ciego 3U
Blank Panel 3U
Panneau plein 3U

B-J019-4U ref.



Painéis Cegos 4U
Panel ciego 4U
Blank Panel 4U
Panneau plein 4U

B-J020 ref.



Dispositivo de ventilação 220V
Fan de ventilación para rack 220V
220V Cooling fan unit
Unité de ventilation 220V

B-J021 ref.



Rodízios com travão
Ruedas con freno
Castors with brake
Roulettes ave freins

B-J022 ref.



Pé de apoio regulável
4 pies de soporte y nivelación
Levelling feet
Pieds réglables en hauteur

B-J023 ref.



Régua de energia de 6 tomadas schuko com interruptor(2U)
Regleta 2U con 6 tomas schuko y interruptor
Power distribution panel with 6 schuko sockets and switch 2U
Bandeau 2U avec 6 prises de courant schuko et interrupteur

B-J024 ref.



Régua de energia tipo PDU com 6 Tomadas schuko e interruptor + protecção de sobretensão (1U)
Regleta tipo PDU con 6 tomas schuko y interruptor + protección contra la sobretensión (1U)
PDU power distribution panel with 6 schuko sockets and switch + overvoltage protection (1U)
Bandeau type PDU avec 6 prises de courant schuko et interrupteur + protection surtensions (1U)



SCAN + INFO



Aço
Acero
Steeil
Acier



Preto
Negro
Black
Noir



B-P004 ref.



Patch Panel 1U 24 RJ45 Cat5e - chave de impacto SL 110
Panel de parcheo 1U 24 RJ45 Cat5e - llave de impacto SL 110
Patch panel 1U 24 RJ45 Cat5e - crimping key SL 110
Panneau de brassage prééquipé 24 RJ45 Cat5e - brassage clé SL 110

B-P005 ref.



Patch Panel 2U 48 RJ45 Cat5e - chave de impacto SL 100
Panel de parcheo 2U 48 RJ45 Cat5e - llave de impacto SL 110
Patch panel 2U 48 RJ45 Cat5e - crimping key SL 110
Panneau de brassage prééquipé 48 RJ45 Cat5e - brassage clé SL 110

B-P012 ref.



Patch Panel 1U 24 RJ45 Cat5e com porta cabos frontal
(cravação chave SL 4110)
Panel de parcheo 1U 24 RJ45 Cat5e - llave de impacto
SL 110 con soporte frontal de cables
Patch panel 1U 24 RJ45 Cat5e - crimping key SL 110
with front cables tray
Panneau de brassage prééquipé 24 RJ45 Cat5e - brassage
clé SL 110 avec guide câbles frontale

B-P016 ref.



Patch Panel 1U 24 RJ45 Cat5e para Bastidor de parede
(cravação chave SL 4110)
Panel de parcheo 1U 24 RJ45 Cat5e - llave de impacto
SL 110 para bastidor de pared
Patch Panel 1U 24 RJ45 Cat5e - crimping key SL 110 for
wall cabinets
Panneau de brassage prééquipé 24RJ45 CAT5e - brassage
clé SL110 pour armoires coffrets

B-P018 ref.



Patch Panel 1U 24 RJ45 Cat6 - cravação chave SL110
com Amarrador de Cabos Posterior
Panel de parcheo 1U 24 RJ45 Cat6 - llave de impacto
SL 110 y con soporte posterior de cables
Patch Panel 1U 24 RJ45 Cat6 - crimping key SL110 with
rear cable tie support
Panneau de brassage prééquipé 24RJ45 CAT6 -brassage
clé SL110 et fixation câbles arrière

B-P019 ref.



Patch Panel 1U 24 RJ45 CAT 6 com Porta Cabos Frontal
Panel de parcheo 1U 24 RJ45 CAT 6 - llave de impacto SL110
con soporte frontal de cables
Patch Panel 1U 24 RJ45 CAT 6 - crimping key SL110 with
front cables tray
Panneau de brassage prééquipé 24RJ45 CAT 6 -brassage
clé SL110 avec guide câbles frontale

B-P020 ref.



Patch Panel 2U 48 RJ45 CAT 6 com Porta Cabos Frontal
Panel de parcheo 1U 48 RJ45 CAT 6 - llave de impacto
SL 110 con soporte frontal de cables
Patch Panel 1U 48 RJ45 CAT 6 - crimping key SL110
with front cables tray
Panneau de brassage prééquipé 48 RJ45 CAT 6 -brassage
clé SL110 avec guide câbles frontale

B-P021 ref.



Patch Panel 1U 24 RJ45 CAT 6 - crav. SL110, com
Amarrador Cabos Posterior (4 mod.s de 6 RJ45)
Panel de parcheo 1U 48 RJ45 CAT6 - llave SL110,
con soporte posterior de cables (4 mod.s de 6 RJ45)
Patch Panel 1U 24 RJ45 Cat6 - crimping key SL110,
with rear cable tie support (4 modules of 6 RJ45)
Panneau de brassage prééquipé 24RJ45 CAT6 -
Clé SL110, fixation câbles arrière (4 mod.s de 6 RJ45)



SCAN + INFO

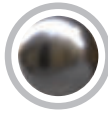

Aço
Acero
Steeel
Acier



Preto
Negro
Black
Noir



B-P022 ^{ref.}



Patch Panel 2U 48 RJ45 CAT 6 - crav. SL110, com Amarrador Cabos Posterior (8 mod.s de 6 RJ45)
Panel de parcheo 1U 48 RJ45 CAT 6 -llave SL110, con soporte posterior de cables (8 mod.s de 6 RJ45)
Patch Panel 1U 48 RJ45 CAT 6 - crimping key SL110 ,with rear cable tie support (8 modules of 6 Rj45)
Panneau de brassage prééquipé 48 RJ45 CAT6 -Clé SL110, fixation câbles arrière (8 mod.s de 6 RJ45)

B-P037-8 ^{ref.}



Placa 1U Repartição de Sinal Coaxial (2400Mhz) com 8 Saídas
Panel de recepción y distribución de señal de TV (5-2400MHz) con 8 salidas - 1U
Panel reception and distribution of TV signal (5-2400MHz) with 8 outputs - 1U
Panneau pour la réception et la distribution signal TV (5-2400MHz) avec 8 sorties type F - 1U

B-P037-16 ^{ref.}



Placa 1U Repartição de Sinal Coaxial (2400Mhz) com 16 Saídas F
Panel de recepción y distribución de señal de TV (5-2400MHz) con 16 salidas F - 1U
Reception and distribution Panel for TV signal (5-2400MHz) with 16 exits type F - 1U
Panneau pour la réception et la distribution signal TV (5-2400MHz) avec 16 sorties type F - 1U

B-P037-24 ^{ref.}



Placa 1U Repartição de Sinal Coaxial (2400Mhz) com 24 Saídas
Panel de recepción y distribución de señal de TV (5-2400MHz) con 24 salidas - 1U
Reception and distribution Panel for TV signal (5-2400MHz) with 24 outputs - 1U
Panneau pour la réception et la distribution signal TV (5-2400MHz) avec 24 sorties type F - 1U

GPX-4820-4 ^{ref.}



Painel de fibra óptica 2U, com 1 Fibox de 4fibras para SC/APC, (não inclui adaptadores AC/APC)
Panel de fibra óptica 2U, con 1 Fibox de 4 adaptadores SC-APC, (adaptadores SC-APC no incluídos)
Optical fiber panel 2U with 1 Fibox of 4 SC-APC connector adapters (SC-APC adapters not included)
Panneau fibre optique 2U avec 1 Fibox de 4 adaptateurs SC-APC (adaptateurs SC-APC non compris)

GPX-4820-12 ^{ref.}



Painel de fibra óptica 1U, para 12 adaptadores de fibra SC/APC (não inclui adaptadores AC/APC)
Panel de fibra óptica 1U para 12 adaptadores SC-APC (adaptadores SC-APC no incluídos)
Optical fiber panel 1U for 12 SC / APC connector adapters (SC-APC adapters not included)
Panneau fibre optique 1U pour 12 adaptateurs SC-APC (adaptateurs SC-APC non compris)

GPX-4820-24 ^{ref.}



Painel de fibra óptica 1U, 24 fibras para SC/APC (não inclui adaptadores AC/APC)
Panel de fibra óptica 1U para 24 adaptadores SC-APC (adaptadores SC-APC no incluídos)
Optical fiber panel 1U for 24 SC / APC connector adapters (SC-APC adapters not included)
Panneau fibre optique 1U pour 24 adaptateurs SC-APC (adaptateurs SC-APC non compris)



SCAN + INFO

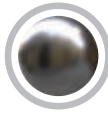

Aço
Acero
Steeil
Acier



Preto
Negro
Black
Noir



B-JG01 ref.



Painel 1U termostato e controlador digital de temperatura com sonda e cabos de ligação
Panel 1U controlador digital de temperatura com termostato y sonda de temperatura + cables de conexión
Panel 1U Digital temperature at controller with probe and connection cables
Panneau 1U Contrôleur numérique de température avec sonde de température et câbles de connexion

B-P050 ref.



Painel de topo com 4 Fans de ventilação para bastidores de chão
Panel superior con 4 ventiladores para gabinetes bastidores de piso
Top panel with 4 Fans ventilation for free standing floor racks
Top panneau avec quatre fans de ventilation pour baie de sol et coffret de serveurs

B-P008-24RJ45 ref.



Painel 1U 19" para alojamento de 24 RJ45 formato AMP (vazio) (Bastidores e RG-PC do ATE)
Panel de 1U de 19" vacío, para alojamiento de 24 RJ45 formato AMP (Bastidores y STDP del RTI)
Empty Panel 1U 19", receives 24 RJ45 AMP Modules (for Racking and TP Splitter at MBTC)
Panneau 1U 19" vide, pour recevoir 24 modules RJ45 type AMP (pour rack et Réseau PT coff. Principal)

B-P040-24SC ref.



Painel 1U 19" para alojamento de 24 adapt.s SC-APC SIMPLEX (vazio) (para Bastidores e RG-FO do ATE)
Panel de 1U de 19" vacío, recibe hasta 24 adapt.s SC-APC SIMPLEX (Bastidores y registro FO del RITI)
Empty Panel 1U 19", receives 24 SC-APC adapters (for Racking and FTTH in the MBTC)
Panneau 1U 19" vide, reçoit 24 Adaptat. SC-APC SIMPLEX (pour rack et Réseau FO coff. Principal)

B-P041-24CC ref.



Painel 1U 19" para alojamento de 24 empalmes tipo F (fem-fem.) vazio. (Bastidores e RG-CC do ATE)
Panel de 1U de 19" vacío, recibe hasta 24 empalmes F (hembra-hembra), (Bastidores y TBA del RITI)
Empty Panel 1U 19", receives 24 F joint coax. Devices (fem.-female), (Racking and CC Splitter at MBTC)
Panneau 1U 19" vide, reçoit 24 connect.s de raccord. F (Fe.-Femelle) (rack et Réseau CC coff. Principal)

B-J043 ref.



Painel 2U 19" vazio para alojamento de 18 blocos tipo KRONE. (Bastidores e RG-CC do ATE)
Panel de 2U de 19" vacío, recibe hasta 18 bloques tipo KRONE, (Bastidores y TBA del RITI)
Empty Panel 2U 19", receives 18 blocks type KRONE, (Racking and CC Splitter at MBTC)
Panneau 2U 19" vide, reçoit 18 bloques type KRONE. (rack et Réseau CC coff. Principal)

RJ45CAT6 ref.



Tomada RJ45 CAT6 tipo AMP para painel ref.ª B-P008
Toma jack RJ45 CAT 6 para Panel Ref. B-P008
RJ45 CAT 6 socket jack, AMP type, for Panel Ref. B-P008
Prise murale RJ45 CAT 6 type AMP pour panneau Ref. B-P008

SC-APC SIMP ref.



Adaptador SC-APC SIMPLEX para paineis de fibra óptica GPX e para painel ref.ª B-P040
Adaptador SC-APC SIMPLEX para paneles de fibra óptica GPX y para Panel Ref. B-P040
SC-APC SIMPLEX adapter for GPX optical fiber panels and for panel Ref. B-P040
Adaptateur SC-APC-SIMPLEX pour panneaux de fibre optique GPX et pour panneau Ref. B-P040

FFF SIMP ref.











Empalme Tipo F (fêmea-fêmea) para cabo coaxial RG-6 para painel Ref. B-P041
Empalme Tipo F (hembra-hembra) para cable coaxial RG6 para paneles Ref. B-P041
Joint type F (fem.-female) for RG6 coaxial cables for panels Ref. B-P041
Connecteur de raccordement type F (femelle-femelle) pour cable coaxial RG-6 pour panneau Ref. B-P041



SCAN + INFO

IP	GRAUS DE PROTECÇÃO	GRADOS DE PROTECCIÓN	PROTECTION DEGREES	DEGRÉS DE PROTECTION
1º algarismo/1ª cifra 1st character/1er chiffre	IP-Protecção contra os corpos sólidos (1º algarismo) e água (2º número)	IP-Protección contra los cuerpos sólidos (1º cifra) y agua (2º cifra)	IP-Protection against entry of solid bodies (1st digit) and water penetration (2nd digit)	IP-Protection contre les corps solides (1er chiffre) et l'eau (2ème chiffre)
	Conforme Normas : IEC 60529, NP EN 60529	Conforme a las Norma : IEC 60529, UNE EN 60529	According to : IEC 60529, BS EN 60529	Conformant aux Normes : CEI 60529, NF EN 60529
0	Sólidos Sem protecção	Solidos Sin protección	Solids None	Solides Pas de protection
1 	Protegido contra os corpos sólidos superiores a 50 mm (ex: contactos involuntários da mão)	Protegido contra cuerpos sólidos superiores a 50 mm (ex: contactos involuntários de la mano)	Protected against solid bodies with minimum dimension greater than 50 mm (ex: involuntary hand contacts)	Protégé contre les corps solides supérieurs à 50 mm (ex: contacts involontaires de la main)
2 	Protegido contra os corpos sólidos superiores a 12,5 mm (ex: dedo da mão)	Protegido contra cuerpos sólidos superiores a 12,5 mm (ex: dedo de la mano)	Protected against solid bodies with minimum dimension greater than 12,5 mm (ex: hand finger)	Protégé contre les corps solides supérieurs à 12,5 mm (ex: doigt de la main)
3 	Protegido contra os corpos sólidos superiores a 2,5 mm (ex: ferramentas, parafusos)	Protegido contra cuerpos sólidos superiores a 2,5 mm (ex: herramientas, tornillos)	Protected against threadlike bodies with diameter greater than 2,5 mm	Protégé contre les corps solides supérieurs à 2,5 mm (ex: outils, vis)
4 	Protegido contra os corpos sólidos superiores a 1 mm (ex: pequenas ferramentas, fios)	Protegido contra cuerpos sólidos superiores a 1 mm (ex: pequeñas herramientas, hilos)	Protected against threadlike bodies with diameter greater than 1 mm	Protégé contre les corps solides supérieurs à 1 mm (ex: outils fins, petit fils)
5 	Protegido contra as poeiras (depósito insignificante)	Protegido contra el polvo (depósito insignificante)	Protected against dust (partial protection)	Protégé contre les poussières (pas de dépôt nuisible)
6 	Protegido totalmente contra as poeiras (nenhum depósito)	Protegido totalmente contra el polvo (ninguno depósito)	Protected against dust (total protection)	Totalement protégé contre les poussières (pas de dépôt)

2º algarismo/ 2ª cifra 2nd character/ 2ème chiffre	Água	Agua	Water	Eau
0	Sem protecção	Sin protección	None	Pas de protection
1 	Protegido contra quedas verticais de gotas de água (condensação)	Protegido contra caída vertical de gotas de agua	Protected against condensate (vertical dripping)	Protégé contre les chutes verticales de gouttes d'eau (condensation)
2 	Protegido contra quedas de gotas de água até 15º da vertical	Protegido contra caída de gotas de agua hasta 15º de la vertical	Protected against drops of water (dripping with angle up to 15º)	Protégé contre les chutes de gouttes d'eau jusqu'à 15º de la verticale
3 	Protegido contra água da chuva até 60º da vertical	Protegido contra agua de lluvia hasta 60º de la vertical	Protected against sprinkling (with angle up to 60º from the vertical)	Protégé contre l'eau en pluie jusqu'à 60º de la verticale
4 	Protegido contra a projecção de água de todas as direcções	Protegido contra rociados de agua	Protected against ejection of water from all directions	Protégé contre les projections d'eau de toutes directions
5 	Protegido contra jactos de água à lança de todas as direcções	Protegido contra vertidos de agua fuertes	Protected against jets from all directions	Protégé contre les jets d'eau de toutes directions à la lance
6 	Protegido contra projecções de água semelhantes a vagas de mar	Protegido contra inmersión temporal	Protected against ejection of water similar to sea waves	Totalement protégé contre les projections d'eau assimilables aux vagues de la mer
7 	Protegido contra os efeitos da imersão	Protegido contra inmersión temporal prolongada	Protected against temporary immersion	Protégé contre les effets de la immersion
8 	Protegido contra os efeitos da imersão prolongada sob pressão	Protegido contra inmersión prolongada	Protected against permanent immersion under pressure	Protégé contre les effets de la e' immersion prolongée sous pression

IK -Resistência ao choque

IK -Protección mecanica contra el impacto

IK -Proteccion against mechanical impact

IK -Protection contre les chocs mécaniques

IK	Energia (J)	Energia (J)	Energy (J)	Energie (J)
00	0	0	0	0
01	0,15	0,15	0,15	0,15
02	0,20	0,20	0,20	0,20
03	0,35	0,35	0,35	0,35
04	0,50	0,50	0,50	0,50
05	0,70	0,70	0,70	0,70
06	1	1	1	1
07	2	2	2	2
08	5	5	5	5
09	10	10	10	10
10	20	20	20	20

TESTE DE ENSAIO DO FIO INCANDESCENTE (de acordo com a norma - IEC 60695-2-10)

TESTE DE ENSAYO DEL HILO INCANDESCENTE (conforme norma - IEC 60695-2-10)

GLOW WIRE TEST (according to - IEC 60695-2-10 standard)

TENUE AU FIL INCANDESCENT (conformant la norme - CEI 60695-2-10)

Aplicação standard	Utilización standard	Standard use	Utilization standard
550° C		Components downlighters or on walls	
650° C	Envolventes à vista	Channels and catwalks in view	Produits d'instalaton superficiale
750° C	Envolventes à vista	Channels and catwalks in view	Produits d'instalaton superficiale
850° C	Artigos embebidos em paredes combustíveis, ocas ou em contacto com partes activa	Components flush-mounted in walls fuels or hollow walls or in contact active parts	Produits encastrés dans des murs combustibles ou cloisons sèches, ou contenant des parties actives
960° C	Artigos embebidos em paredes combustíveis ou suportando partes activas	Components flush-mounted in walls fuels or holding in place active parts	Produits encastrés dans des murs combustibles ou soutient des parties actives

Os valores podem ser diferentes se assim o exigir o regulamento local

Valores diferentes cuando el regulamen-local lo exija

Different values can be exiged by local regulations

Les réglemets locaux peuvent fixer des valeurs différentes

JSL

Material Eléctrico

Sede | Headquarters | Siège Social

Rua Mário Castelhana, nº3 - Zona Industrial Queluz de Baixo
2730 – 120 Barcarena - Portugal
Tel (+351) 214 344 670 | Fax (+351) 214 353 150
M (+351) 919975067 - (+351) 932 535 255 - (+351) 962736709

Fábrica | Factory | Usine

Estrada das Palmeiras 34, Queluz de Baixo
2734-504 Barcarena - Portugal

Sucursal em Espanha | Spanish Branch | Sucursal en España

Avenida Democracia Nº 7 Nave 112 Planta 1 - 28031 Madrid - España
Tel (+34) 91 332 28 28 Fax (+34) 91 332 0151
info.jsl@gmail.com

JSL

Material Eléctrico

JSL - Material Eléctrico, S.A

Sede | Headquarters | Siège Social

Rua Mário Castelhana, nº3 - Zona Industrial Queluz de Baixo
2730 - 120 Barcarena - Portugal
Tel (+351) 214 344 670 | Fax (+351) 214 353 150
M (+351) 919975067 - (+351) 932 535 255 - (+351) 962736709

Fábrica | Factory | Usine

Estrada das Palmeiras 34, Queluz de Baixo
2734-504 Barcarena - Portugal

Sucursal em Espanha | Spanish Branch | Sucursal en España

Avenida Democracia Nº 7 Nave 112 Planta 1 - 28031 Madrid - España
Tel (+34) 91 332 28 28 Fax (+34) 91 332 0151
info.jsl@gmail.com

