

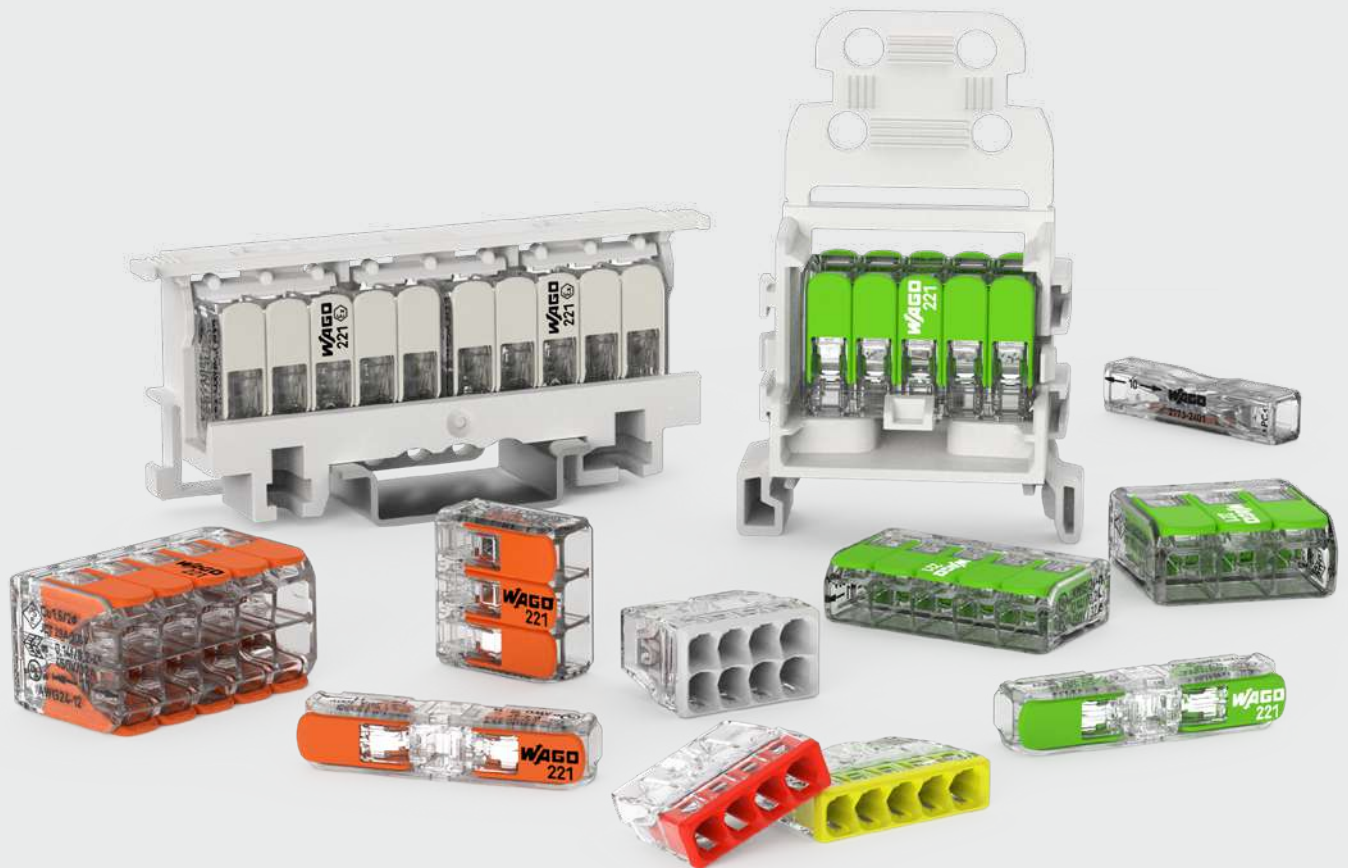

# WAGO Installation Connectors

Edition 2025/2



## WAGO Full Line Catalogs



### WAGO Installation Connectors

- Splicing Connectors with Levers
- Inline Splicing Connectors with Levers
- Lighting Connectors
- PUSH WIRE® Splicing Connectors
- PUSH WIRE® Inline Splicing Connectors
- Luminaire Disconnect Connectors
- Gelboxes for Splicing Connectors
- Junction Box
- Cable Repair Set
- Splicing Connector Sets
- Accessories and Tools



### WAGO TOPJOB® S Rail-Mount Terminal Block Systems

- Rail-Mount Terminal Blocks TOPJOB® S
- Rail-Mount Terminal Blocks with a Pluggable Connector X-COM®-SYSTEM
- Installation Rail-Mount Terminal Blocks TOPJOB® S
- Miniature Rail-Mount Terminal Blocks TOPJOB® S
- High-Current Rail-Mount Terminal Blocks
- Accessories and Tools



### WAGO Rail-Mount Terminal Blocks Classic

- Rail-Mount Terminal Blocks Classic
- Rail-Mount Terminal Blocks with a Pluggable Connector X-COM®-SYSTEM
- Patchboard Systems
- Busbar Terminal Blocks
- Rail-Mount Terminal Blocks Mini
- Modular Terminal Blocks and WAGO Terminal Strips
- Chassis-Mount Terminal Strips
- Field-Wiring Terminal Blocks



### WAGO PCB Terminal Blocks and Connectors

- PCB Terminal Blocks (THT; THR; SMD)
- *MULTI CONNECTION SYSTEM (MCS)*
- *picoMAX®; picoMAX® eCom*
- Pluggable PCB Terminal Blocks
- Feedthrough Terminal Strips
- Special Connectors
- Modulare Empty Housing
- Accessories and Tools



### WAGO Pluggable Connection System WINSTA®

- Pluggable Connectors
- Snap-In Device Connectors
- Pluggable PCB Connectors
- Distribution Connectors
- Cable Assemblies
- Flat Cable Systems
- Distribution Boxes
- Accessories and Tools



**WAGO**

**WAGO Automation Technology**

Edition 2020/2

## WAGO Automation Technology

- Solutions & Software
- Operating & Monitoring
- Controllers, Edge Devices
- Modular I/O-SYSTEM IP20, I/O-SYSTEM IP67
- Industrial Switches
- Radio Technology
- IP67 Sensor/Actuator Boxes, IP67 Cables and Connectors



**WAGO**

**WAGO Interface Electronics**

Edition 2020/2

## WAGO Interface Electronics

- Coupler Relays
- Solid-State Relays
- Signal Conditioners and Isolation Amplifiers
- Energy Measurement Technology
- System Wiring
- Component Modules
- Empty Housing
- Protective Devices and Protective Electronics
- Accessories and Tools



**WAGO**

**WAGO Power Supply Systems**

Edition 2020/2

## WAGO Power Supply Systems

- Power Supplies; 1-Phase
- Power Supplies; 3-Phase
- Special Supplies
- Circuit Protection
- DC/DC Converters
- UPS-Charger and Controllers and Capacitive Buffer Modules
- Redundancy Modules
- Energy Measurement Technology
- Potential Distribution
- Accessories and Tools



**WAGO**

**WAGO Marking**

Edition 2020/2

## WAGO Marking

- Thermal Transfer Smart Printer
- Digital Engineering – Smart Data
- Products for the Smart Printer
- Printed Products
- Plain Products
- Marker Carries



# About this Catalog

Our digital catalogs provide several search and navigation features to help you quickly find the information you need. This page introduces the key functions of the catalog.

## Searching the Catalog

To search for specific terms within the catalog, follow these steps:

- Open the search dialog via **Edit > Find** or by clicking the magnifying glass icon. Alternatively, use the **Ctrl + F** keyboard shortcut.
- Enter your search term in the search field.
- Click **Next** to move to the next search result.

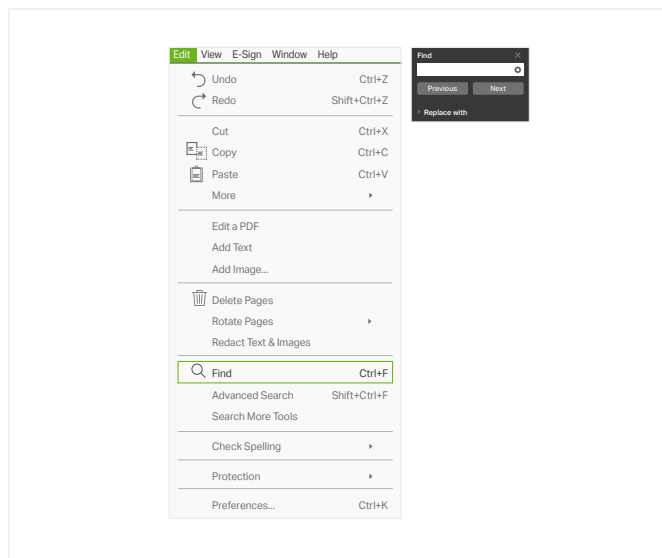

## Navigating with Bookmarks

This PDF includes bookmarks to help you quickly and easily find specific sections. With a single click, you can jump directly to a chapter in the catalog.

- Open the bookmark panel by clicking the **bookmark icon**.
- To navigate to a chapter, click the relevant bookmark in the bookmark panel. The corresponding catalog page will then be displayed.

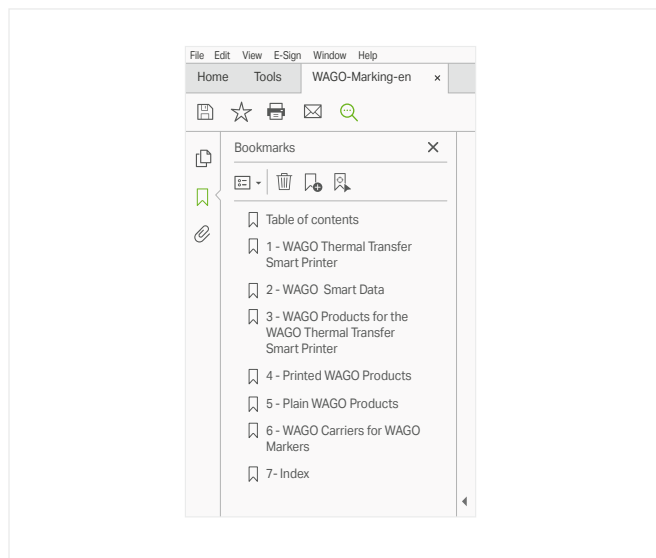

## Navigating with the Table of Contents

Our table of contents includes clickable page numbers, allowing you to jump directly to the corresponding catalog page.

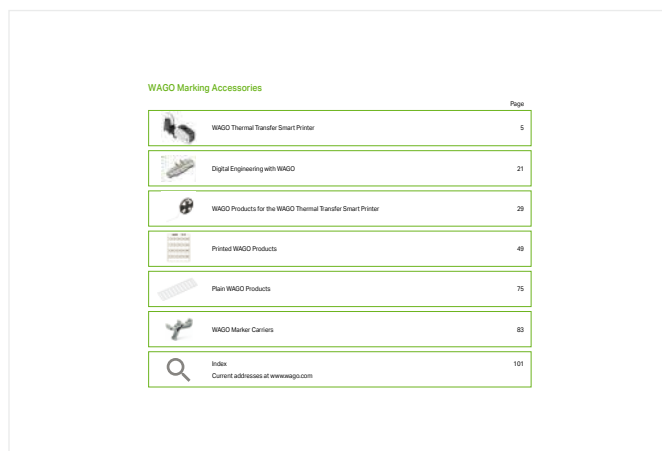

You can also find additional clickable page numbers in the selection guides and the item number index.

## Links

To help you access additional information easily, this catalog includes links to various websites. These links may provide further product details, installation notes or quick access to important documents such as data sheets.







One example is our **item numbers**, which contain links to the corresponding product detail pages on our website. Simply click an item number to open the relevant product detail page.

You can identify links in this catalog by the presence of a URL in the link text (e.g., [www.wago.com](http://www.wago.com)). In most cases, links are also underlined for easy recognition.



Item No.	PU	258-5100
258-5100	1	

## WAGO Splicing Connectors

		Page
	<b>Splicing Connectors with Levers</b> <b>Inline Splicing Connectors with Levers</b> <b>Lighting Connectors</b>	Push-in CAGE CLAMP® 2.5 ... 6 mm <sup>2</sup> 3
	<b>PUSH WIRE® Splicing Connectors</b> <b>PUSH WIRE® Inline Splicing Connectors</b> <b>Luminaire Disconnect Connectors</b>	Push WIRE® 2.5 ... 6 mm <sup>2</sup> 0.4 ... 0,8 mm Ø 33
	<b>Gelboxes for Splicing Connectors</b> <b>Junction Box</b> <b>Cable Repair Set</b>	63
	<b>Splicing Connector Sets</b>	PUSH WIRE® / Push-in CAGE CLAMP® 2.5 ... 6 mm <sup>2</sup> 75
	<b>WAGO Accessories and WAGO Tools</b>	87
	<b>Technical Section</b>	115
	<b>Indexes</b> <b>Current Adresses at <a href="http://www.wago.com">www.wago.com</a></b>	167









# WAGO Splicing Connectors with Levers

## WAGO Lighting Connectors

## WAGO Splicing Connectors with Levers

### WAGO Lighting Connectors

			Page
	<b>Splicing Connectors with Levers - Green Range</b> for all Conductor Types 4 mm <sup>2</sup> (12 AWG) 6 mm <sup>2</sup> (10 AWG)	221 Series	6 8
	<b>Inline Splicing Connectors with Levers - Green Range</b> for all Conductor Types 4 mm <sup>2</sup> (12 AWG)	221 Series	10
	<b>Splicing Connectors with Levers</b> for all Conductor Types 4 mm <sup>2</sup> (12 AWG) 6 mm <sup>2</sup> (10 AWG)	221 Series	14 16
	<b>Inline Splicing Connectors with Levers</b> for all Conductor Types 4 mm <sup>2</sup> (12 AWG)	221 Series	18
	<b>Splicing Connectors with Levers - for Ex eb Applications</b> for all Conductor Types 4 mm <sup>2</sup> (12 AWG) 6 mm <sup>2</sup> (10 AWG)	221 Series	22 24
	<b>Splicing Connectors with Levers</b> for all Conductor Types 2.5 mm <sup>2</sup> (14 AWG)	222 Series	28
	<b>Lighting Connectors</b> for all Conductor Types 2.5 mm <sup>2</sup> (14 AWG)	224 Series	30

# Splicing connectors with levers ▶ Green Range ▶ for all conductor types ▶ 4 mm<sup>2</sup> and 6 mm<sup>2</sup>

## 221 Series

### Description and Installation

1



4 mm<sup>2</sup>: Strip conductor to 11 mm (0.43 inch).  
6 mm<sup>2</sup>: Strip conductor to 12 ... 14 mm (0.47 ... 0.55 inch).



Termination: Lift the lever to open the clamping unit and insert a stripped conductor.



Then lower the lever to close the clamp.



4 mm<sup>2</sup>: Tool-free connection of up to 10 stripped, fine-stranded conductors from 0.14 ... 4 mm<sup>2</sup>, as well as solid or stranded conductors from 0.2 ... 4 mm<sup>2</sup> (24 ... 12 AWG).  
6 mm<sup>2</sup>: Tool-free connection of up to five stripped, fine-stranded as well as solid or stranded conductors from 0.5 ... 6 mm<sup>2</sup> (20 ... 10 AWG).



Testing via test slots.



Wiring in the distribution box.



Strip conductor to 11 mm (0.43 inch).



Testing via test slots.



Wiring in the distribution box.



Wiring in the ceiling light.

The WAGO Green Range Splicing Connectors with Levers and the WAGO Green Range Inline Splicing Connectors with Levers offer the same trusted performance and features as their counterparts with orange levers. The difference? These versions are crafted from certified bio-circular (based on bio-residuals from industries and households, as well as bio-gas) and recycled plastics (post-consumer recyclates). This sustainable material choice helps conserve fossil resources while keeping existing plastics in circulation. Specifically, the levers (PBT) of the 4 mm<sup>2</sup> WAGO Green Range Splicing Connector contain at least 27% recycled PET bottles. The levers of the 6 mm<sup>2</sup> WAGO Green Range Splicing Connector and 4 mm<sup>2</sup> WAGO Inline Splicing Connector feature approximately 26%

bio-circular plastics (based on biogas).

The housing is made from up to 77% bio-based residuals such as tall oil, waste fats and by-products from cooking oil production. These materials are transformed through advanced processes into high-quality polycarbonate, reducing the reliance on fossil resources.

These connectors offer the same high performance and certifications as the traditional 221 Series, making them a more sustainable alternative without any sacrifice in quality. The WAGO 221 Series Green Range Splicing Connector is ideal for manufacturers, building technology professionals and electrical installers looking to integrate sustainable solutions into their processes and projects.

77 % bio-circular

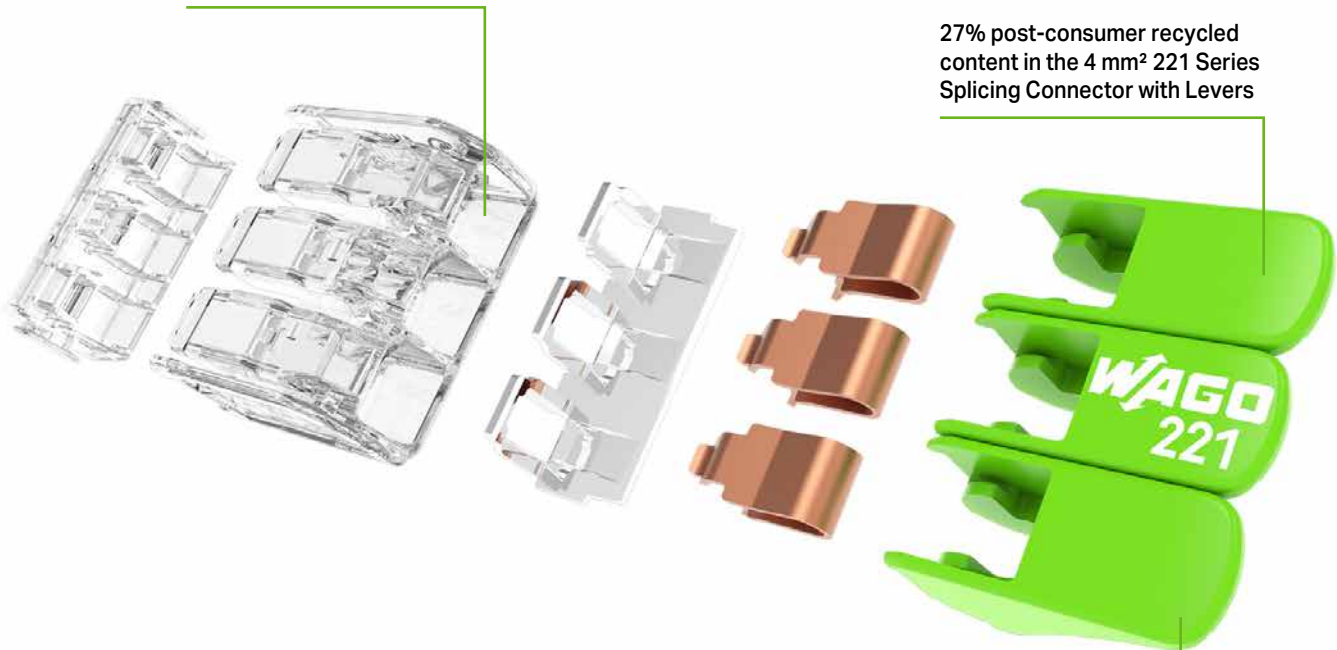

27% post-consumer recycled content in the 4 mm<sup>2</sup> 221 Series Splicing Connector with Levers

26% bio-circular content in the 6 mm<sup>2</sup> 221 Series Splicing Connector with Levers and 221 Series Inline Splicing Connector with Levers

Splicing Connector with Levers ▶ 221 Series ▶ 4 mm<sup>2</sup> ▶ Housing color: transparent

1



- Your Benefits:
- Plastics made in part from post-consumer recycled material (e.g. recycled PET bottles) and bio-based residues from industries, households, agriculture and wastewater treatment
- Reduced consumption of fossil resources
- Ease of use – pull the lever up, insert a conductor and push the lever back down
- Available as 2-, 3-, 5- and 10-wire connectors
- Easily terminate conductors from 0.14 to 4 mm<sup>2</sup>
- Connect solid, stranded and fine-stranded conductors
- Time savings for installers and device manufacturers
- Quickly install devices with higher power consumption
- Safely install long cable runs with larger conductor cross sections

**Electrical data**

Ratings per	EN 60664		
Overvoltage category	III	III	II
Pollution degree	3	2	2
Nominal voltage	-	-	450 V
Rated surge voltage	-	-	4 kV
Rated current	-	-	32 A
Approvals per	UL 486C		
Use group	B	C	D
Rated voltage	-	600 V	-
Rated current	-	20 A	-

**Connection data**

Connection technology	CAGE CLAMP®
Strip length	11 mm / 0.43 inches
Connectable conductor materials	Copper
Nominal cross-section	4 mm <sup>2</sup> / 12 AWG
Solid conductor	0.2 ... 4 mm <sup>2</sup> / 24 ... 12 AWG
Stranded conductor	0.2 ... 4 mm <sup>2</sup> / 24 ... 12 AWG
Fine-stranded conductor	0.14 ... 4 mm <sup>2</sup> / 24 ... 12 AWG

**Material data**

Material group	IIIa
Insulation material (main housing)	Polycarbonate (PC)
Flammability class per UL94	V2

**Environmental requirements**

Ambient temperature (operation)	+85 °C
Temperature marking per EN 60998	T85

**Note:**  
in grounded power lines

General accessories Page 65

Mounting adapter Page 93

See technical section for further information

Approvals and corresponding ratings, visit [www.wago.com](http://www.wago.com)

# Splicing Connector with Levers ▶ 221 Series ▶ 4 mm<sup>2</sup> ▶ Housing color: transparent

Clamping units: 2



Clamping units: 3

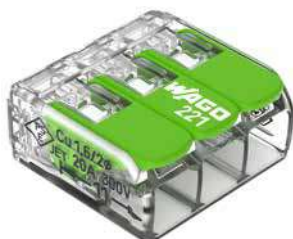

Clamping units: 5



221-422

Actuator color	Item No.	PU (SPU)
green	221-422	1000 (100)

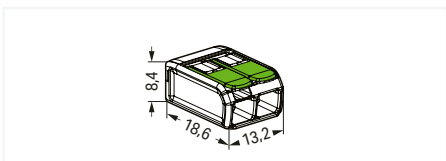

Item-Specific Accessories



Mounting carrier; DIN-35 rail, Screw mount

Color	Item No.	PU (SPU)
orange	221-500	50 (10)
dark gray/yellow	221-500/000-053	50 (10)
blue	221-500/000-006	50 (10)

221-423

Actuator color	Item No.	PU (SPU)
green	221-423	500 (50)

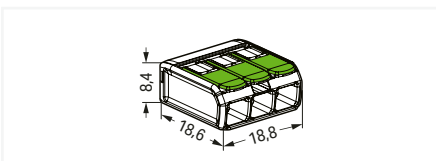

Item-Specific Accessories



Mounting carrier; DIN-35 rail, Screw mount

Color	Item No.	PU (SPU)
orange	221-500	50 (10)
dark gray/yellow	221-500/000-053	50 (10)
blue	221-500/000-006	50 (10)

221-425

Actuator color	Item No.	PU (SPU)
green	221-425	250 (25)

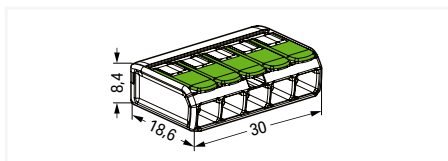

Item-Specific Accessories



Mounting carrier; DIN-35 rail, Screw mount

Color	Item No.	PU (SPU)
orange	221-500	50 (10)
dark gray/yellow	221-500/000-053	50 (10)
blue	221-500/000-006	50 (10)

Clamping units: 10



221-430

Actuator color	Item No.	PU (SPU)
green	221-430	150 (15)

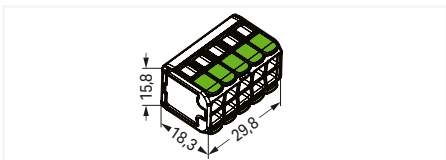

Accessories; for all products on this page



Jumper; with locking function

Color	Item No.	PU
blue	221-941/000-006	5
dark gray	221-941	5



Jumper

Color	Item No.	PU
blue	221-942/000-006	5
dark gray	221-942	5

PU = packaging unit; SPU = subpackaging unit; Dimensions in mm

Splicing Connector with Levers ▶ 221 Series ▶ 6 mm<sup>2</sup> ▶ Housing color: transparent

1



- Your Benefits:
- Plastics made in part from post-consumer recycled material (e.g. recycled PET bottles) and bio-based residues from industries, households, agriculture and wastewater treatment
- Reduced consumption of fossil resources
- Ease of use – pull the lever up, insert a conductor and push the lever back down
- Available as 2-, 3- and 5-wire connectors
- Easily terminate conductors from 0.5 to 6 mm<sup>2</sup>
- Connect solid, stranded and fine-stranded conductors
- Time savings for installers and device manufacturers
- Quickly install devices with higher power consumption
- Safely install long cable runs with larger conductor cross sections

Electrical data						
Ratings per	EN 60664			EN 60664		
Overvoltage category	III	III	II	III	III	II
Pollution degree	3	2	2	3	2	2
Nominal voltage	-	-	450 V	-	-	450 V
Rated surge voltage	-	-	4 kV	-	-	4 kV
Rated current	-	-	41 A	-	-	41 A
Approvals per	UL 486C			UL 486C		
Use group	B	C	D	B	C	D
Rated voltage	-	600 V	-	-	600 V	-
Rated current	-	30 A	-	-	30 A	-
Connection data						
Connection technology	CAGE CLAMP®					
Strip length	12 ... 14 mm / 0.47 ... 0.55 inches					
Connectable conductor materials	Copper					
Nominal cross-section	6 mm <sup>2</sup> / 10 AWG					
Solid conductor	0.5 ... 6 mm <sup>2</sup> / 20 ... 10 AWG					
Stranded conductor	0.5 ... 6 mm <sup>2</sup> / 20 ... 10 AWG					
Fine-stranded conductor	0.5 ... 6 mm <sup>2</sup> / 20 ... 10 AWG					
Material data						
Material group	IIIa					
Insulation material (main housing)	Polycarbonate (PC)					
Flammability class per UL94	V2					
Environmental requirements						
Continuous operating temperature	105 °C					
Ambient temperature (operation)	+85 °C					
Temperature marking per EN 60998	T85					

**Note:**  
in grounded power lines

General accessories Page 66

See technical section for further information

Approvals and corresponding ratings, visit [www.wago.com](http://www.wago.com)

# Splicing Connector with Levers ▶ 221 Series ▶ 6 mm<sup>2</sup> ▶ Housing color: transparent

Clamping units: 2

Clamping units: 3

Clamping units: 5



221-622

Actuator color	Item No.	PU (SPU)
green	221-622	500 (50)

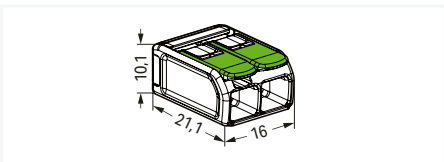

221-623

Actuator color	Item No.	PU (SPU)
green	221-623	300 (30)

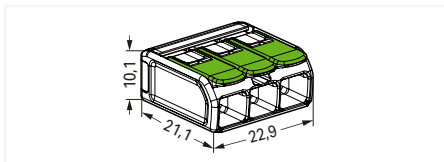

221-625

Actuator color	Item No.	PU (SPU)
green	221-625	150 (15)

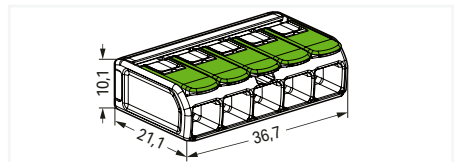

1

## Accessories; for all products on this page



Jumper; with locking function

Color	Item No.	PU
● blue	221-941/000-006	5
● dark gray	221-941	5



Jumper

Color	Item No.	PU
● blue	221-942/000-006	5
● dark gray	221-942	5



Mounting carrier; DIN-35 rail, Screw mount

Color	Item No.	PU (SPU)
● orange	221-510	50 (10)
● dark gray/yellow	221-510/000-053	50 (10)
● blue	221-510/000-006	50 (10)

PU = packaging unit; SPU = subpackaging unit

## Inline Splicing Connector with Levers ▶ 221 Series ▶ 4 mm<sup>2</sup> ▶ Clamping units: 2 ▶ Housing color: transparent ▶ Actuator color: green

1



- This connector is suitable for worldwide installations.
- Plastics made in part from post-consumer recycled material (e.g. recycled PET bottles) and bio-based residues from industries, households, agriculture and wastewater treatment
- Reduced consumption of fossil resources
- Inline connection of solid, stranded and fine-stranded conductors from 0.2 to 4 mm<sup>2</sup> (24–16 AWG)
- Slim design saves space in tight areas
- Tool-free connection and disconnection thanks to convenient lever technology
- Use a mounting carrier for fixed and multi-pole wiring

### Electrical data

Ratings per	EN 60664		
Overvoltage category	III	III	II
Pollution degree	3	2	2
Nominal voltage	-	-	450 V
Rated surge voltage	-	-	4 kV
Rated current	-	-	32 A

### Connection data

Connection technology	CAGE CLAMP®
Strip length	11 mm / 0.43 inches
Connectable conductor materials	Copper

### Material data

Material group	IIIa
Insulation material (main housing)	Polycarbonate (PC)
Flammability class per UL94	V2

### Environmental requirements

Continuous operating temperature	-60 ... +105 °C
----------------------------------	-----------------

General accessories Page 69

Installation Page 97

See technical section for further information

Approvals and corresponding ratings, visit [www.wago.com](http://www.wago.com)

Inline Splicing Connector with Levers ▶ 221 Series ▶ 4 mm<sup>2</sup> ▶ Clamping units: 2 ▶ Housing color: transparent ▶ Actuator color: green

14 AWG



12 AWG



221-2431

Cover color	Item No.	PU (SPU)
transparent	221-2431	600 (60)



221-2421

Cover color	Item No.	PU (SPU)
white	221-2421	600 (60)

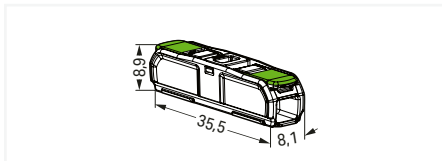

Accessories; for all products on this page



Mounting Carrier, with strain relief; Screw mount

Design	Item No.	PU (SPU)
1x	221-2501	25 (5)
2x	221-2502	25 (5)
3x	221-2503	25 (5)
4x	221-2504	25 (5)
5x	221-2505	25 (5)



Mounting Carrier, with strain relief; Snap-in foot

Design	Item No.	PU (SPU)
1x	221-2511	25 (5)
2x	221-2512	25 (5)
3x	221-2513	25 (5)
4x	221-2514	25 (5)
5x	221-2515	25 (5)



Mounting carrier; Screw mount

Design	Item No.	PU (SPU)
1x	221-2521	25 (5)
2x	221-2522	25 (5)
3x	221-2523	25 (5)
4x	221-2524	25 (5)
5x	221-2525	25 (5)



Mounting carrier; Snap-in foot

Design	Item No.	PU (SPU)
1x	221-2531	25 (5)
2x	221-2532	25 (5)
3x	221-2533	25 (5)
4x	221-2534	25 (5)
5x	221-2535	25 (5)

PU = packaging unit; SPU = subpackaging unit; Dimensions in mm

# Splicing Connector with levers ▶ for all conductor types ▶ 4 mm<sup>2</sup> and 6 mm<sup>2</sup>

## 221 Series

### Description and Installation

1

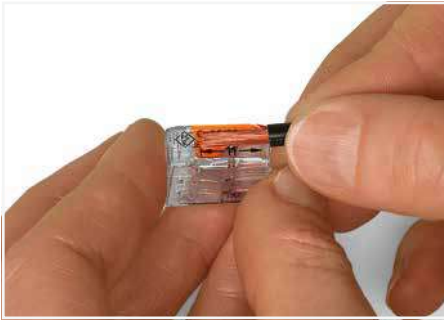

4 mm<sup>2</sup>: Strip conductor to 11 mm (0.43 inch).  
6 mm<sup>2</sup>: Strip conductor to 12 ... 14 mm (0.47 ... 0.55 inch).

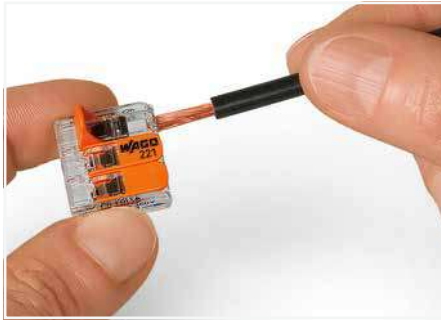

Termination: Lift the lever to open the clamping unit and insert a stripped conductor.

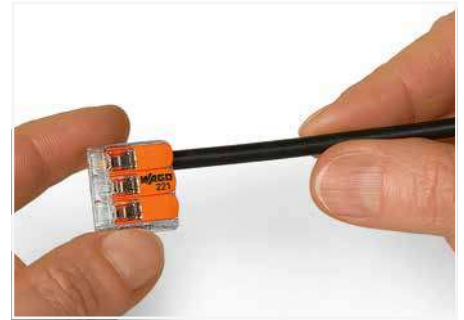

Then, lower the lever to close the clamp.

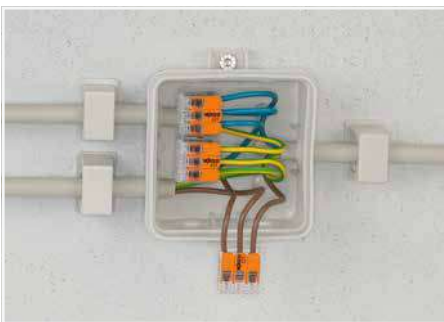

Wiring fine-stranded conductors in a junction box.



Custom low-voltage lighting system

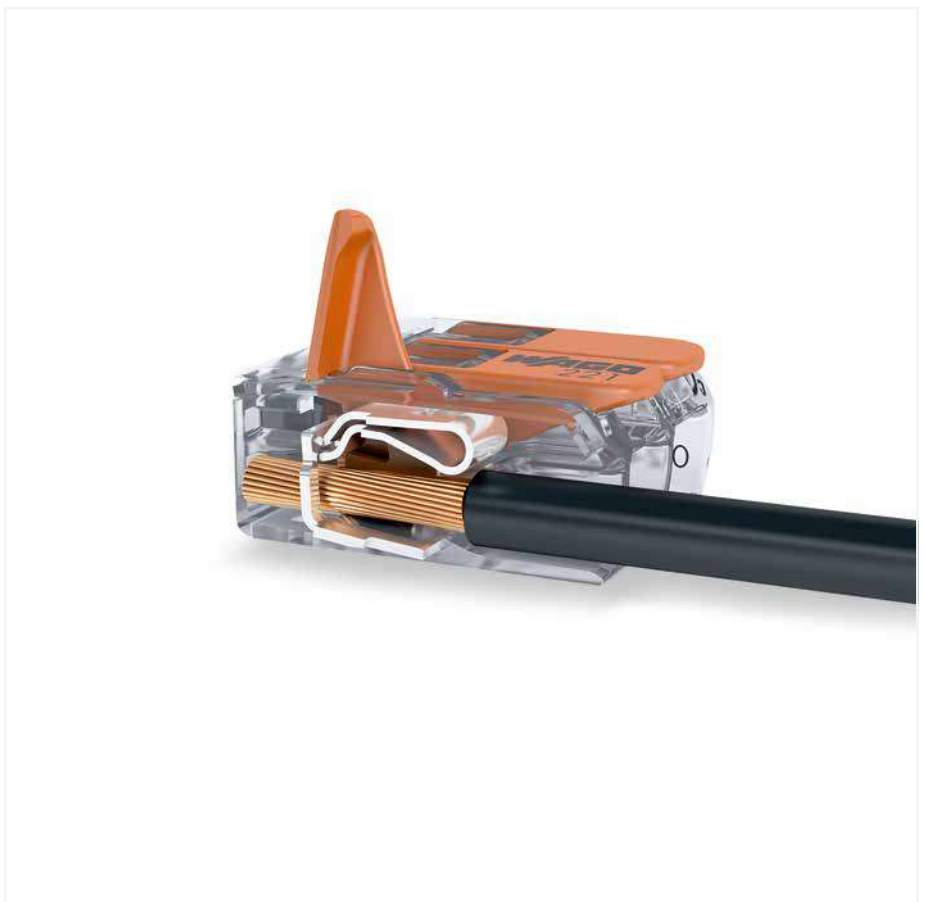

Wiring fine-stranded conductors in a junction box for in-floor heating.



Lighting distribution in ceiling canopy



Pendant light connection in suspended ceilings

# Inline Splicing Connectors ▶ 4 mm<sup>2</sup>

## 221 Series

### Description and Installation



Push up the lever to open the clamping unit and insert the conductor.



Push the lever back down.

**Your Benefits:**

- Inline connection of solid, stranded and fine-stranded conductors from 0.2 to 4 mm<sup>2</sup>
- Slim design needs minimum space in tight areas
- Tool-free connection and disconnection thanks to convenient lever technology
- Use a mounting carrier for fixed and multi-pole wiring

1

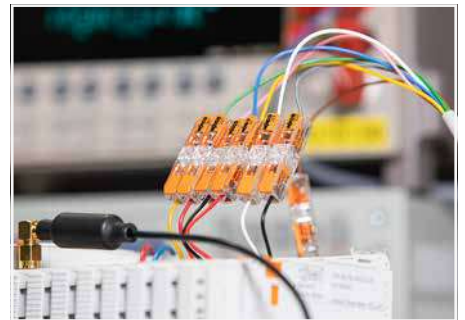
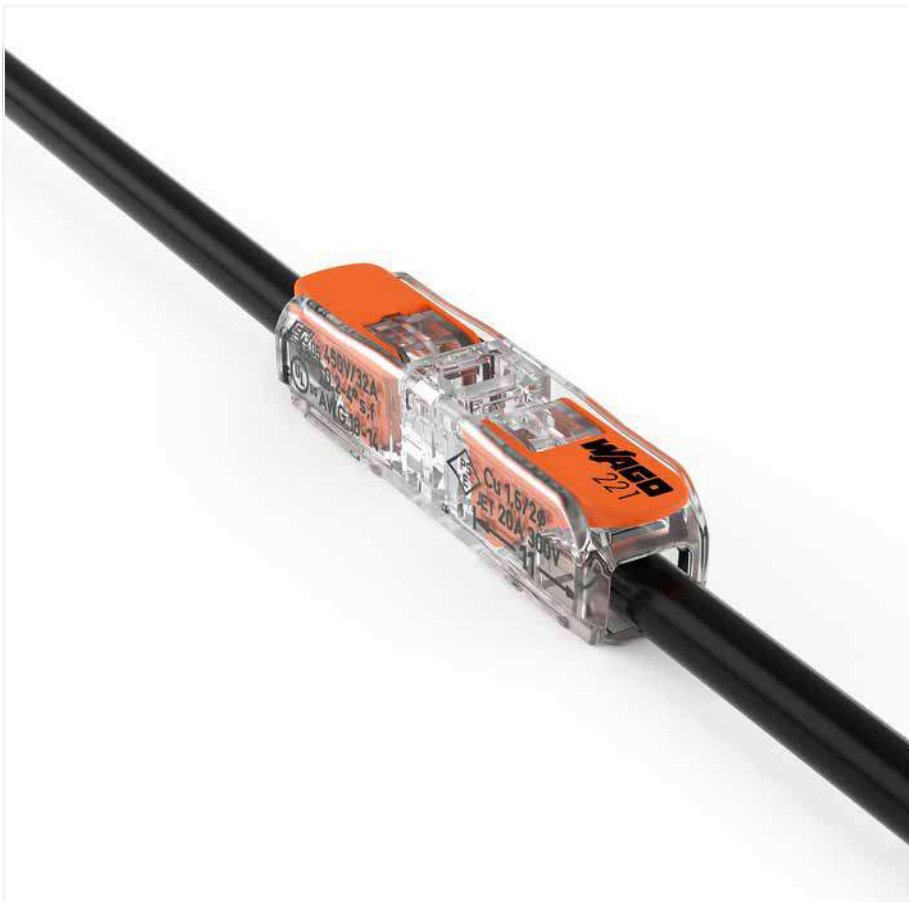

Perfect for test setups



Simple extension of lines



Lighting connection in suspended ceilings



Multi-pole, fixed lighting fixture wiring

Splicing Connector with Levers ▶ 221 Series ▶ 4 mm<sup>2</sup> ▶ Housing color: transparent

- Your benefits:
- Ease of use – pull the lever up, insert a conductor and push the lever back down
- Available as 2-, 3-, 5- and 10-wire connectors
- Easily terminate conductors from 0.14 to 4 mm<sup>2</sup>
- Connect solid, stranded and fine-stranded conductors
- Save time for installers and device manufacturers
- Quickly install devices with higher power consumption
- Safely install long cable runs with larger conductor cross sections
- Mounting carrier for installation conforms to standards
- Custom carriers are possible

**Electrical data**

Ratings per	EN 60664		
Overtoltage category	III	III	II
Pollution degree	3	2	2
Nominal voltage	-	-	450 V
Rated surge voltage	-	-	4 kV
Rated current	-	-	32 A
Approvals per	UL 486C		
Use group	B	C	D
Rated voltage	-	600 V	-
Rated current	-	20 A	-

**Connection data**

Connection technology	CAGE CLAMP®
Strip length	11 mm / 0.43 inches
Connectable conductor materials	Copper
Nominal cross-section	4 mm <sup>2</sup> / 12 AWG
Solid conductor	0.2 ... 4 mm <sup>2</sup> / 24 ... 12 AWG
Stranded conductor	0.2 ... 4 mm <sup>2</sup> / 24 ... 12 AWG
Fine-stranded conductor	0.14 ... 4 mm <sup>2</sup> / 24 ... 12 AWG

**Material data**

Material group	IIIa
Insulation material (main housing)	Polycarbonate (PC)
Flammability class per UL94	V2

**Environmental requirements**

Ambient temperature (operation)	+85 °C
Temperature marking per EN 60998	T85

**Note:**  
in grounded power lines

General accessories Page 65

Mounting adapter Page 93

See technical section for further information

Approvals and corresponding ratings, visit [www.wago.com](http://www.wago.com)

# Splicing Connector with Levers ▶ 221 Series ▶ 4 mm<sup>2</sup> ▶ Housing color: transparent

Clamping units: 2



Clamping units: 3



Clamping units: 5



221-412

Actuator color	Item No.	PU (SPU)
orange	221-412	1000 (100)

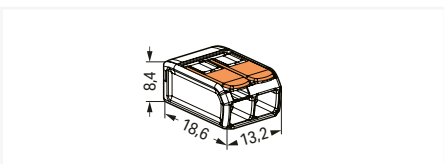

Item-Specific Accessories



Mounting carrier; DIN-35 rail, Screw mount

Color	Item No.	PU (SPU)
orange	221-500	50 (10)
dark gray/yellow	221-500/000-053	50 (10)
blue	221-500/000-006	50 (10)

221-413

Actuator color	Item No.	PU (SPU)
orange	221-413	500 (50)

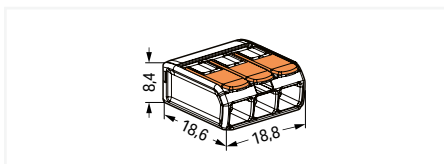

Item-Specific Accessories



Mounting carrier; DIN-35 rail, Screw mount

Color	Item No.	PU (SPU)
orange	221-500	50 (10)
dark gray/yellow	221-500/000-053	50 (10)
blue	221-500/000-006	50 (10)

221-415

Actuator color	Item No.	PU (SPU)
orange	221-415	250 (25)

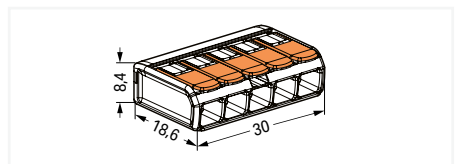

Item-Specific Accessories



Mounting carrier; DIN-35 rail, Screw mount

Color	Item No.	PU (SPU)
orange	221-500	50 (10)
dark gray/yellow	221-500/000-053	50 (10)
blue	221-500/000-006	50 (10)

Clamping units: 10



221-420

Actuator color	Item No.	PU (SPU)
orange	221-420	150 (15)

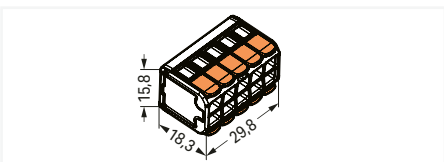

Accessories; for all products on this page



Jumper; with locking function

Color	Item No.	PU
blue	221-941/000-006	5
dark gray	221-941	5



Jumper

Color	Item No.	PU
blue	221-942/000-006	5
dark gray	221-942	5

PU = packaging unit; SPU = subpackaging unit; Dimensions in mm

Splicing Connector with Levers ▶ 221 Series ▶ 6 mm<sup>2</sup> ▶ Housing color: transparent

1



## • Your benefits:

- Ease of use – pull the lever up, insert a conductor and push the lever back down
- Available as 2-, 3- and 5-wire connectors
- Easily terminate conductors from 0.5 to 6 mm<sup>2</sup>
- Connection of all conductor types
- Time savings for installers and device manufacturers
- Quickly install devices with higher power consumption
- Safely install long cable runs with larger conductor cross sections
- Mounting carrier for installation conforms to standards
- Custom carriers are possible

**Electrical data**

Ratings per	EN 60664		
Overvoltage category	III	III	II
Pollution degree	3	2	2
Nominal voltage	-	-	450 V
Rated surge voltage	-	-	4 kV
Rated current	-	-	41 A
Approvals per	UL 486C		
Use group	B	C	D
Rated voltage	-	600 V	-
Rated current	-	30 A	-

**Connection data**

Connection technology	CAGE CLAMP®
Strip length	12 ... 14 mm / 0.47 ... 0.55 inches
Connectable conductor materials	Copper
Nominal cross-section	6 mm <sup>2</sup> / 10 AWG
Solid conductor	0.5 ... 6 mm <sup>2</sup> / 20 ... 10 AWG
Stranded conductor	0.5 ... 6 mm <sup>2</sup> / 20 ... 10 AWG
Fine-stranded conductor	0.5 ... 6 mm <sup>2</sup> / 20 ... 10 AWG

**Material data**

Material group	IIIa
Insulation material (main housing)	Polycarbonate (PC)
Flammability class per UL94	V2

**Environmental requirements**

Continuous operating temperature	105 °C
Ambient temperature (operation)	+85 °C
Temperature marking per EN 60998	T85

**Note:**  
in grounded power lines

General accessories Page 66

See technical section for further information

Approvals and corresponding ratings, visit [www.wago.com](http://www.wago.com)

# Splicing Connector with Levers ▶ 221 Series ▶ 6 mm<sup>2</sup> ▶ Housing color: transparent

Clamping units: 2

Clamping units: 3

Clamping units: 5



221-612

Actuator color	Item No.	PU (SPU)
orange	221-612	500 (50)

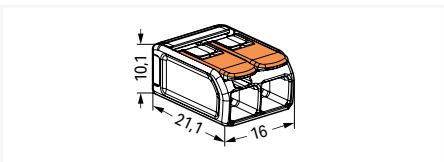

221-613

Actuator color	Item No.	PU (SPU)
orange	221-613	300 (30)

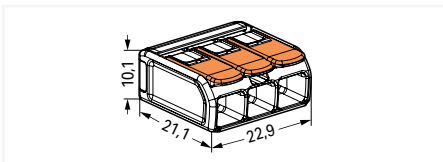

221-615

Actuator color	Item No.	PU (SPU)
orange	221-615	150 (15)

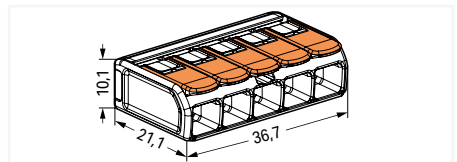

## Accessories; for all products on this page



Jumper; with locking function

Color	Item No.	PU
● blue	221-941/000-006	5
● dark gray	221-941	5



Jumper

Color	Item No.	PU
● blue	221-942/000-006	5
● dark gray	221-942	5



Mounting carrier; DIN-35 rail, Screw mount

Color	Item No.	PU (SPU)
● orange	221-510	50 (10)
● dark gray/yellow	221-510/000-053	50 (10)
● blue	221-510/000-006	50 (10)

PU = packaging unit; SPU = subpackaging unit; Dimensions in mm

## Inline Splicing Connector with Levers ▶ 221 Series ▶ 4 mm<sup>2</sup> ▶ Clamping units: 2 ▶ Housing color: transparent ▶ Actuator color: orange

1



- This connector is suitable for worldwide installations.
- Inline connection of solid, stranded and fine-stranded conductors from 0.2 to 4 mm<sup>2</sup> (24–16 AWG)
- Slim design saves space in tight areas
- Tool-free connection and disconnection thanks to convenient lever technology
- Use a mounting carrier for fixed and multi-pole wiring

### Electrical data

Ratings per	EN 60664		
Overvoltage category	III	III	II
Pollution degree	3	2	2
Nominal voltage	-	-	450 V
Rated surge voltage	-	-	4 kV
Rated current	-	-	32 A

### Connection data

Connection technology	CAGE CLAMP®
Strip length	11 mm / 0.43 inches
Connectable conductor materials	Copper

### Material data

Material group	IIIa
Insulation material (main housing)	Polycarbonate (PC)
Flammability class per UL94	V2

### Environmental requirements

Continuous operating temperature	-60 ... +105 °C
----------------------------------	-----------------

General accessories Page 69

Installation Page 97

See technical section for further information

Approvals and corresponding ratings, visit [www.wago.com](http://www.wago.com)

Inline Splicing Connector with Levers ▶ 221 Series ▶ 4 mm<sup>2</sup> ▶ Clamping units: 2 ▶ Housing color: transparent ▶ Actuator color: orange

14 AWG



12 AWG



221-2411

Cover color	Item No.	PU (SPU)
transparent	221-2411	600 (60)

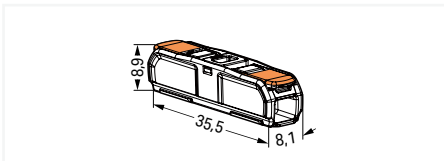

221-2401

Cover color	Item No.	PU (SPU)
white	221-2401	600 (60)

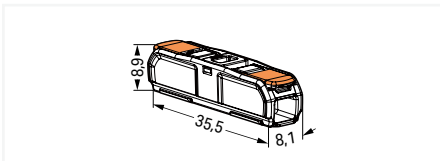

Accessories; for all products on this page



Mounting Carrier, with strain relief; Screw mount

Design	Item No.	PU (SPU)
1x	221-2501	25 (5)
2x	221-2502	25 (5)
3x	221-2503	25 (5)
4x	221-2504	25 (5)
5x	221-2505	25 (5)



Mounting Carrier, with strain relief; Snap-in foot

Design	Item No.	PU (SPU)
1x	221-2511	25 (5)
2x	221-2512	25 (5)
3x	221-2513	25 (5)
4x	221-2514	25 (5)
5x	221-2515	25 (5)



Mounting carrier; Screw mount

Design	Item No.	PU (SPU)
1x	221-2521	25 (5)
2x	221-2522	25 (5)
3x	221-2523	25 (5)
4x	221-2524	25 (5)
5x	221-2525	25 (5)



Mounting carrier; Snap-in foot

Design	Item No.	PU (SPU)
1x	221-2531	25 (5)
2x	221-2532	25 (5)
3x	221-2533	25 (5)
4x	221-2534	25 (5)
5x	221-2535	25 (5)

PU = packaging unit; SPU = subpackaging unit

# Splicing connectors with levers ▶ for applications Ex eb ▶ for all types of conductors ▶ 4 mm<sup>2</sup> 221 Series Description and Handling

1

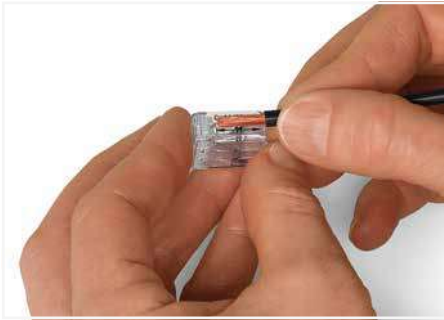

4 mm<sup>2</sup>: Strip conductor to 11 mm (0.43 inch).  
6 mm<sup>2</sup>: Strip conductor to 12 ... 14 mm (0.47 ... 0.55 inch).

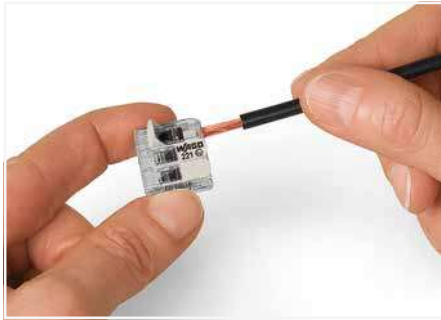

Termination: Lift the lever to open the clamping unit and insert a stripped conductor.

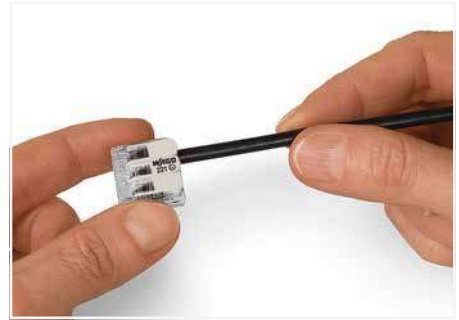

Then, lower the lever to close the clamp.



Inserting a connector into the mounting carrier.



Removing a connector from the mounting carrier.



Removing a conductor.



Mounting type (440 V)  
A spacer integrated in the adapter can be seen between two connectors.



Mounting type (440 V)  
Vertical mounting on DIN-35 rail



Mounting type (275 V)  
A spacer integrated in the adapter cannot be seen between two connectors; the connector housings are close together.

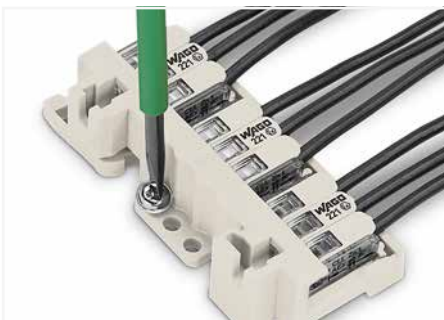

Mounting type (440 V)  
Horizontal screw mounting on a flat surface



Mounting type (440 V)  
Mounting the carrier via non-conductive screws.



Mounting type (275 V)  
Mounting the carrier using conductive screws.

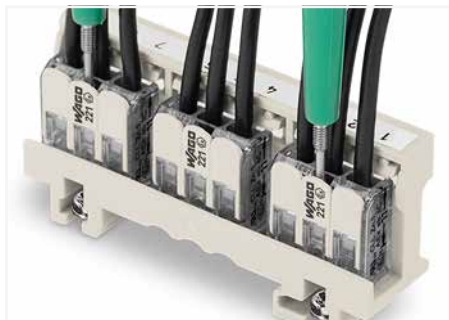

Easily test inserted connectors in the carrier – however they are mounted.



Wiring example in an Ex e junction box  
Labeling is performed via marking strips (210-334) and pen or continuous labels (210-834), which is printed via Smart Printer (258-5000).



Carriers with a blue insulated housing are suitable for Ex i applications. Both clearances and creepage distances for the protection type "intrinsic safety Ex i" must be observed.

Splicing Connector with Levers ▶ 221 Series ▶ 4 mm<sup>2</sup> ▶ Housing color: transparent

- Your benefits:
- Ease of use – pull the lever up, insert a conductor and push the lever back down
- Available as 2-, 3-, 5- and 10-wire connectors
- Easily terminate conductors from 0.14 to 4 mm<sup>2</sup>
- Connect solid, stranded and fine-stranded conductors
- Save time for installers and device manufacturers
- Quickly install devices with higher power consumption
- Safely install long cable runs with larger conductor cross sections
- Mounting carrier for installation conforms to standards
- Working voltages of 275 V or 440 V
- Custom carriers are possible

**Electrical data**

Approvals per	UL 60079		
Use group	B	C	D
Rated voltage	-	440 V	-
Rated current	-	20 A	-

**Electrical data**

Ratings per	ATEX: PTB 18 ATEX 1019 U / IECEx: PTB 18.0045U (Ex eb IIC Gb)
Rated voltage EN (Ex e II)	440 V

**Connection data**

Connection technology	CAGE CLAMP®
Connectable conductor materials	Copper
Nominal cross-section	4 mm <sup>2</sup> / 12 AWG
Solid conductor	0.2 ... 4 mm <sup>2</sup> / 24 ... 12 AWG
Stranded conductor	0.2 ... 4 mm <sup>2</sup> / 24 ... 12 AWG
Fine-stranded conductor	0.14 ... 4 mm <sup>2</sup> / 24 ... 12 AWG

**Material data**

Material group	IIIa
Insulation material (main housing)	Polycarbonate (PC)
Flammability class per UL94	V2

**Note:**

The permissible operating voltage of the connector with carrier (440 V or 275 V) depends on the mounting type. Only approved in conjunction with a mounting carrier (221-501). Other carriers are possible, see certificate/file. The connectors must be installed in an enclosure meeting the requirements of a recognized protection type per EN 60079-0, GB/T 3836.1 Section 1 or EN 60079-31, GB/T 3836.31. When installing the connectors in an enclosure of protection type "e" (increased safety per EN 60079-7, GB/T 3836.3), the clearances and creepage distances of Table 2 for this standard must be observed. See point 1 for the use of accessories. The connectors can be used both in Group II and Group I, as the standard requirements are identical in this case.

The use of these components requires a new assessment by a notified certification agency.

Mounting adapter Page 95

For general Ex information, see technical section; for electrical data, see [www.wago.com](http://www.wago.com), "Certificates" tab on product

See technical section for further information

Approvals and corresponding ratings, visit [www.wago.com](http://www.wago.com)

# Splicing Connector with Levers ▶ 221 Series ▶ 4 mm<sup>2</sup> ▶ Housing color: transparent

Clamping units: 2



Clamping units: 3



Clamping units: 5



221-482

Actuator color	Item No.	PU (SPU)
light gray	221-482	1000 (100)

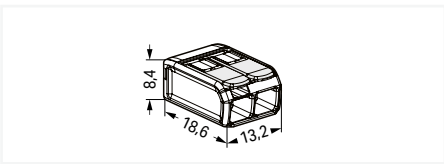

Item-Specific Accessories



Mounting carrier; DIN-35 rail, Screw mount

Color	Item No.	PU (SPU)
○ light gray	221-501	50 (10)
● blue	221-500/000-006	50 (10)

221-483

Actuator color	Item No.	PU (SPU)
light gray	221-483	500 (50)

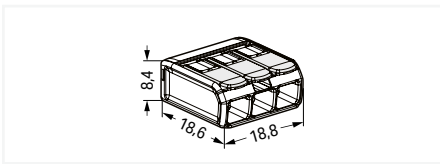

Item-Specific Accessories



Mounting carrier; DIN-35 rail, Screw mount

Color	Item No.	PU (SPU)
○ light gray	221-501	50 (10)
● blue	221-500/000-006	50 (10)

221-485

Actuator color	Item No.	PU (SPU)
light gray	221-485	250 (25)

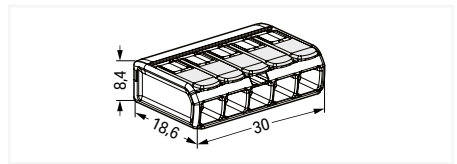

Item-Specific Accessories



Mounting carrier; DIN-35 rail, Screw mount

Color	Item No.	PU (SPU)
○ light gray	221-501	50 (10)
● blue	221-500/000-006	50 (10)

Clamping units: 10



221-490

Actuator color	Item No.	PU (SPU)
light gray	221-490	150 (15)

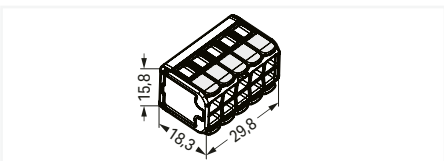

PU = packaging unit; SPU = subpackaging unit; Dimensions in mm

Splicing Connector with Levers ▶ 221 Series ▶ 6 mm<sup>2</sup> ▶ Housing color: transparent

1



## • Your benefits:

- Ease of use – pull the lever up, insert a conductor and push the lever back down
- Available as 2-, 3- and 5-wire connectors
- Easily terminate conductors from 0.5 to 6 mm<sup>2</sup>
- Connection of all conductor types
- Time savings for installers and device manufacturers
- Quickly install devices with higher power consumption
- Safely install long cable runs with larger conductor cross sections
- Mounting carrier for installation conforms to standards
- Working voltages of 275 V or 440 V

**Electrical data**

Approvals per	UL 60079		
Use group	B	C	D
Rated voltage	-	440 V	-
Rated current	-	30 A	-

**Electrical data**

Ratings per	ATEX: PTB 19 ATEX 1001 U / IECEx: PTB 19.001 1U (Ex eb IIC Gb)
Rated voltage EN (Ex e II)	440 V
Rated current (Ex e II)	37 A

**Connection data**

Connection technology	CAGE CLAMP®
Strip length	12 ... 14 mm / 0.47 ... 0.55 inches
Connectable conductor materials	Copper
Nominal cross-section	6 mm <sup>2</sup> / 10 AWG
Solid conductor	0.5 ... 6 mm <sup>2</sup> / 20 ... 10 AWG
Stranded conductor	0.5 ... 6 mm <sup>2</sup> / 20 ... 10 AWG
Fine-stranded conductor	0.5 ... 6 mm <sup>2</sup> / 20 ... 10 AWG

**Material data**

Material group	IIIa
Insulation material (main housing)	Polycarbonate (PC)
Flammability class per UL94	V2

**Environmental requirements**

Continuous operating temperature	-55 ... +105 °C
----------------------------------	-----------------

**Note:**

The permissible operating voltage of the connector with carrier (440 V or 275 V) depends on the mounting type. Only approved in conjunction with a mounting carrier (221-511). Other carriers are possible, see certificate/file. The connectors must be installed in an enclosure meeting the requirements of a recognized protection type per EN 60079-0, Section 1 or EN 60079-31.

When installing the connectors in an enclosure of protection type "eb" (increased safety) per EN 60079-7, the clearances and creepage distances of Table 2 for this standard must be observed. See point 1 for the use of accessories. The connectors can be used both in Group II and Group I, as the standard requirements are identical in this case.

The use of these components requires a new assessment by a notified certification agency.

See technical section for further information

Approvals and corresponding ratings, visit [www.wago.com](http://www.wago.com)

# Splicing Connector with Levers ▶ 221 Series ▶ 6 mm<sup>2</sup> ▶ Housing color: transparent

Clamping units: 2

Clamping units: 3

Clamping units: 5



221-682

221-683

221-685

Actuator color	Item No.	PU (SPU)
light gray	221-682	500 (50)

Actuator color	Item No.	PU (SPU)
light gray	221-683	300 (30)

Actuator color	Item No.	PU (SPU)
light gray	221-685	150 (15)

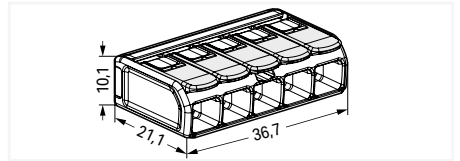
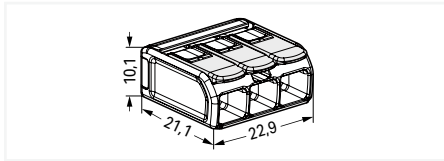
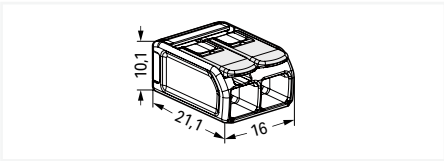

1

## Accessories; for all products on this page



Mounting carrier; DIN-35 rail, Screw mount

Color	Item No.	PU (SPU)
○ light gray	221-511	50 (10)
● blue	221-510/000-006	50 (10)

PU = packaging unit; SPU = subpackaging unit; Dimensions in mm

## Splicing connectors with levers ▶ for all conductor types ▶ 2.5 mm<sup>2</sup>

### 222 Series

#### Description and Installation

1

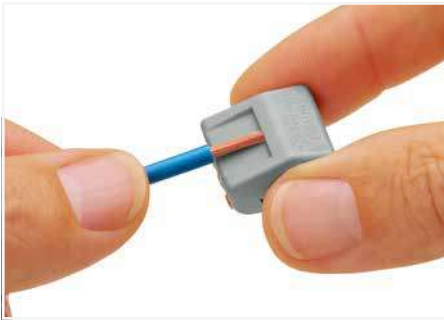

Strip conductor to 9 ... 10 mm (0.35 ... 0.39 inch).

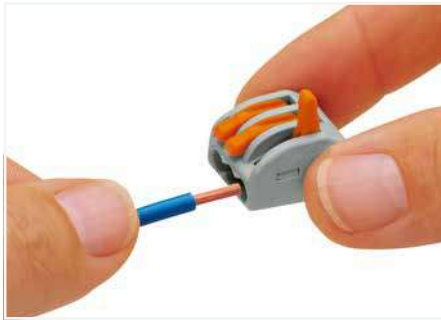

Termination: Lift the lever to open the clamping unit and insert a stripped conductor.

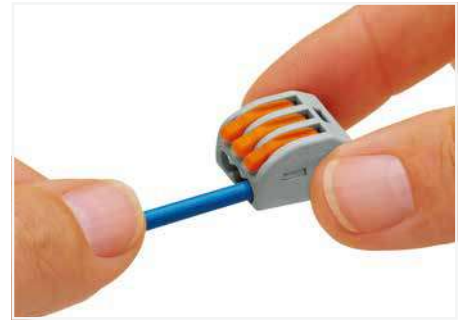

Then, lower the lever to close the clamp.

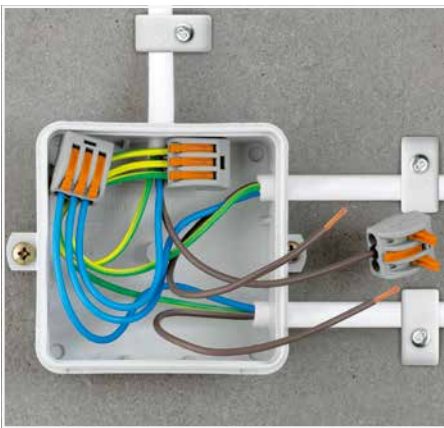

Wiring fine-stranded conductors in a junction box.

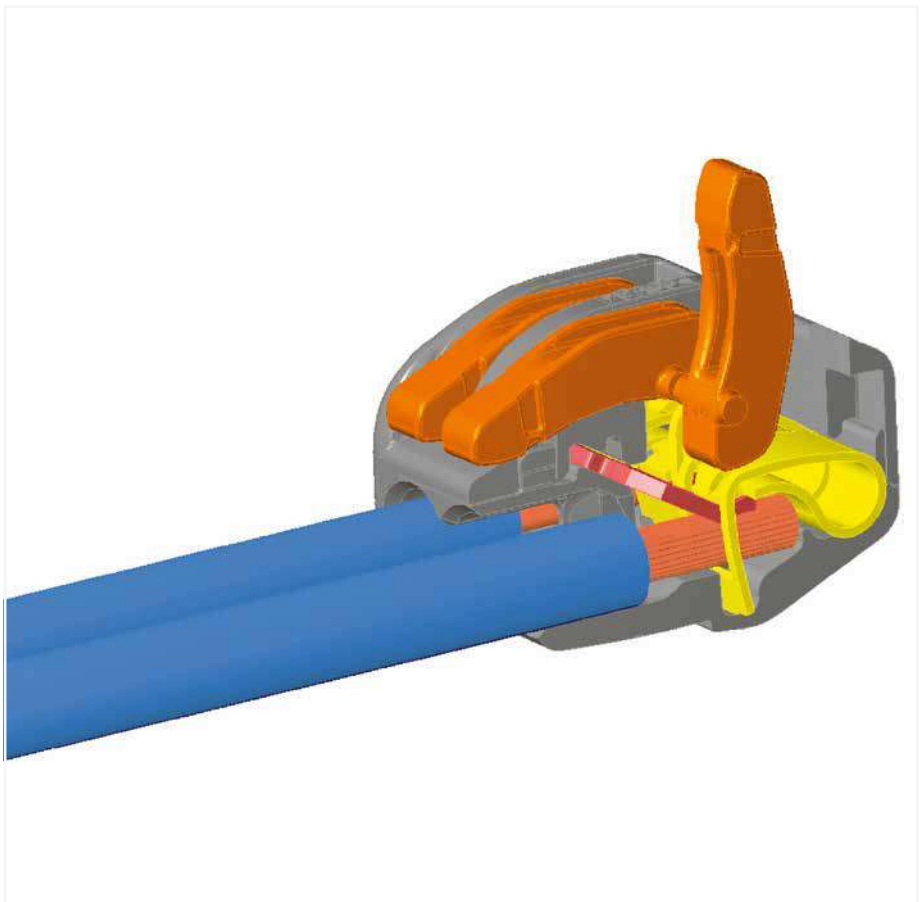

Testing the wired connectors.



Splicing Connector with Levers ▶ 222 Series ▶ 2.5 mm<sup>2</sup> ▶ Housing color: gray

1



Electrical data			
Ratings per	EN 60664		
Overvoltage category	III	III	II
Pollution degree	3	2	2
Nominal voltage	-	-	400 V
Rated surge voltage	-	-	4 kV
Rated current	-	-	32 A
Connection data			
Connection technology	CAGE CLAMP®		
Strip length	9 ... 10 mm / 0.35 ... 0.39 inches		
Connectable conductor materials	Copper; Aluminum		
Solid conductor	0.08 ... 2.5 mm <sup>2</sup> / 28 ... 12 AWG		
Stranded conductor	0.08 ... 2.5 mm <sup>2</sup> / 28 ... 12 AWG		
Fine-stranded conductor	0.08 ... 4 mm <sup>2</sup> / 28 ... 12 AWG		
Material data			
Flammability class per UL94	V0		
Environmental requirements			
Continuous operating temperature	85 °C		
Ambient temperature (operation)	+40 °C		

**Note:**  
in grounded power lines

See technical section for further information

Approvals and corresponding ratings, visit [www.wago.com](http://www.wago.com)

## Splicing Connector with Levers ▶ 222 Series ▶ 2.5 mm<sup>2</sup> ▶ Housing color: gray

Clamping units: 2

Clamping units: 3

Clamping units: 5



222-412

Actuator color	Item No.	PU (SPU)
orange	222-412	500 (50)

222-413

Actuator color	Item No.	PU (SPU)
orange	222-413	500 (50)

222-415

Actuator color	Item No.	PU (SPU)
orange	222-415	400 (40)

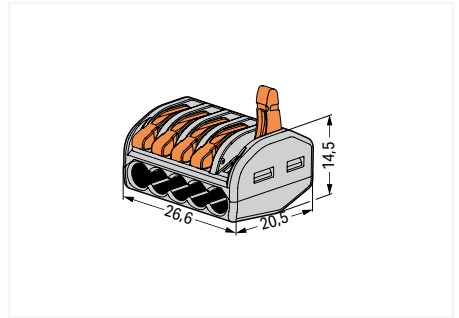
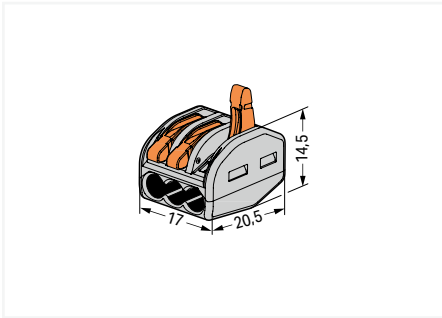
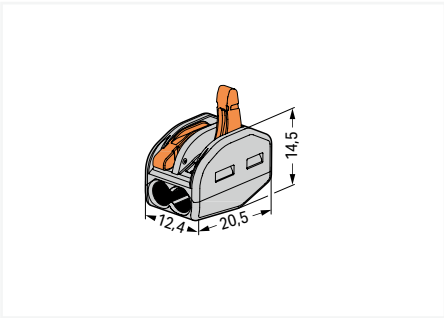

1

### Accessories; for all products on this page



Mounting carrier; DIN-35 rail, Screw mount

Color	Item No.	PU (SPU)
orange	222-500	50 (10)

PU = packaging unit; SPU = subpackaging unit; Dimensions in mm

# Lighting Connectors ▶ 224 Series

## Lighting Side and Installation Side

### Description and Installation

1

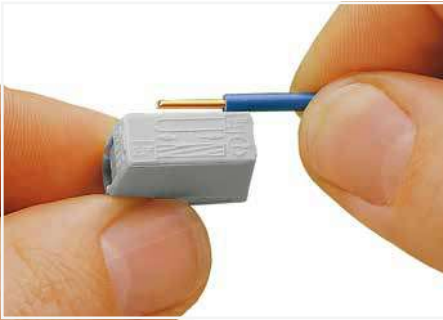

Strip conductor to 9 ... 11 mm (0.35 ... 0.43 inch).

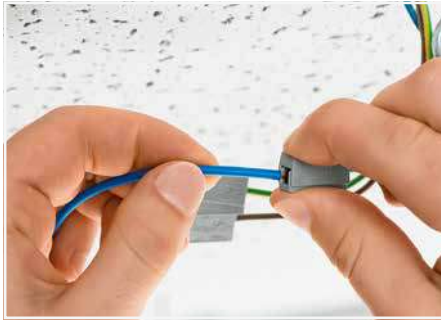

To connect: Press button fully, insert stripped conductor into square entry and release.

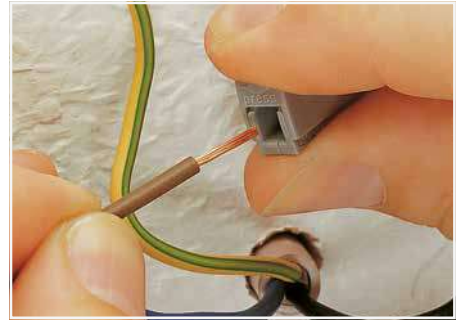

To remove: Press button and withdraw conductor.

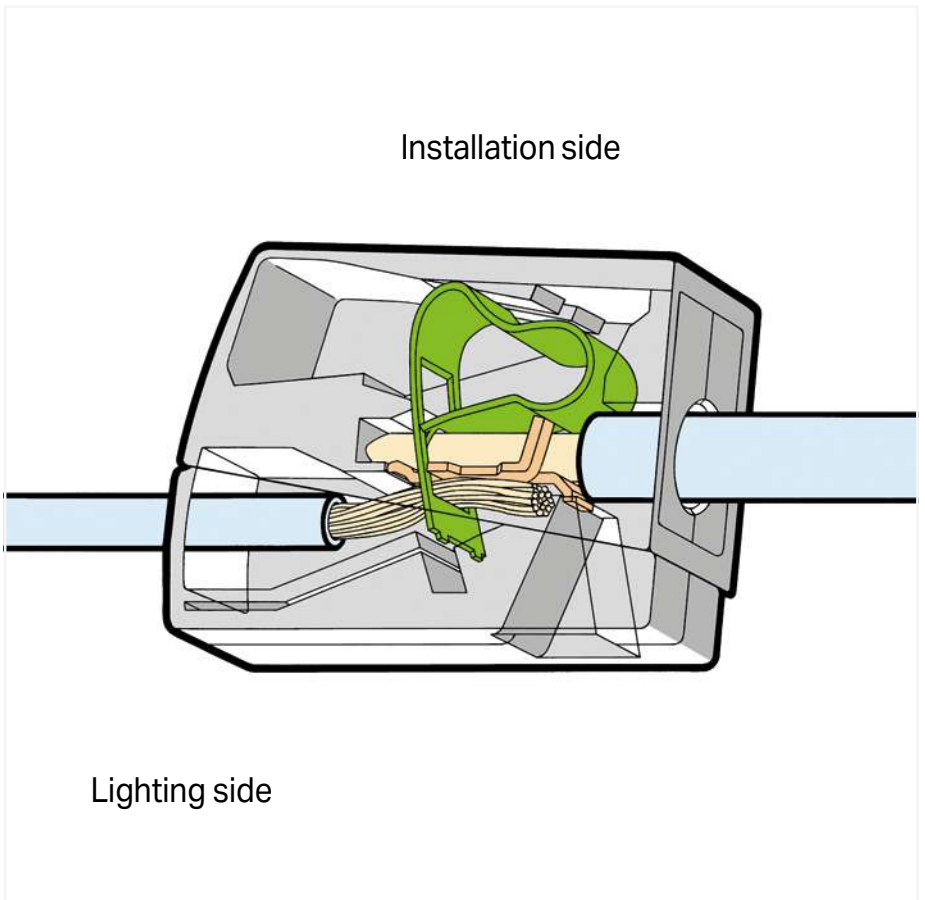

To connect: Insert stripped solid conductor into circular entry and push until it hits the backstop.

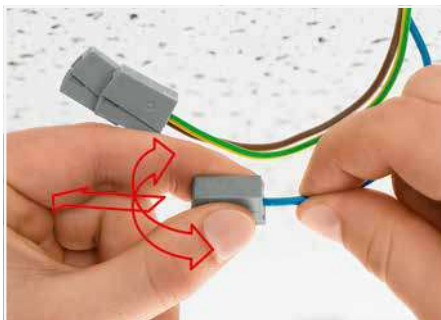

To remove: Hold conductor to be removed and twist alternately left and right while slightly pulling the connector.



Testing via separate test ports.

# Lighting Connector and Service Connector ▶ 2.5 mm<sup>2</sup> 224 Series

Technical Data	
Installation side	
1 ... 2.5 mm <sup>2</sup> "s"	14 ... 12 AWG
Lighting side	
0.5 ... 2.5 mm <sup>2</sup> "s+f-st"	20 ... 16 AWG
400 V/4 kV/2	300 V, 20 A <sup>Ⓢ</sup>
I <sub>N</sub> 24 A	300 V, 20 A <sup>Ⓢ</sup>
9 ... 11 mm / 0.35 ... 0.43 inch	

Technical Data	
Installation side	
1 ... 2.5 mm <sup>2</sup> "s"	16 ... 14 AWG
Lighting side	
0.5 ... 2.5 mm <sup>2</sup> "s+f-st"	20 ... 16 AWG
400 V/4 kV/2	300 V, 20 A <sup>Ⓢ</sup>
I <sub>N</sub> 24 A	300 V, 20 A <sup>Ⓢ</sup>
9 ... 11 mm / 0.35 ... 0.43 inch	

Technical Data	
0.5 ... 2.5 mm <sup>2</sup> "s+f-st"	20 ... 16 AWG
400 V/4 kV/2	300 V, 20 A <sup>Ⓢ</sup>
I <sub>N</sub> 24 A	
9 ... 11 mm / 0.35 ... 0.43 inch	



Lighting connector; Standard version; Continuous operating temperature (max.): 105 °C; Surrounding air temperature (max.): 60 °C		
Color	Item No.	Pack. Unit
○ gray	224-101	1000 (100)

2-wire lighting connector; Standard version; Continuous operating temperature (max.): 105 °C; Surrounding air temperature (max.): 60 °C		
Color	Item No.	Pack. Unit
○ white	224-112	1000 (100)

Service connector		
Color	Item No.	Pack. Unit
○ gray	224-201	50

Lighting connector; Version for increased continuous operating temperature: 120 °C; Surrounding air temperature (max.): 75 °C		
Color	Item No.	Pack. Unit
● black	224-104	100

2-wire lighting connector; Version for increased continuous operating temperature: 120 °C; Surrounding air temperature (max.): 75 °C		
Color	Item No.	Pack. Unit
● black	224-114	100

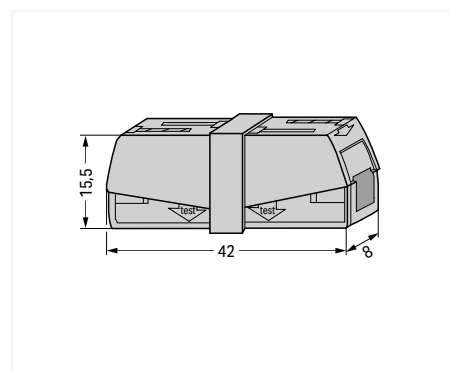
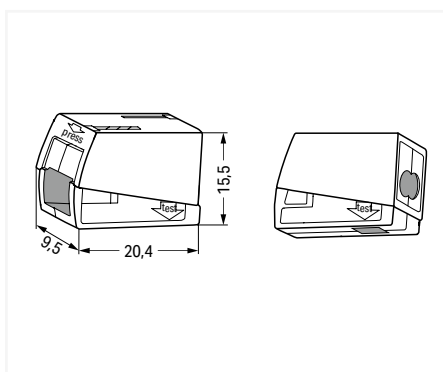
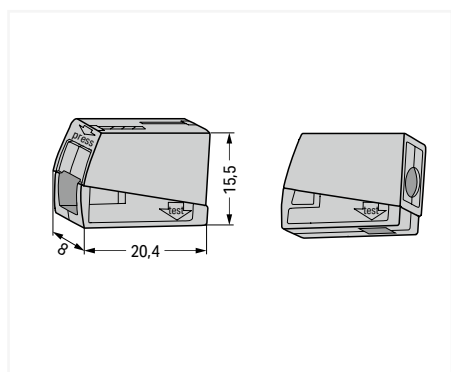

Accessories; for all products on this page	
Syringe; contains 20 ml "Alu-Plus" Contact Paste	
	249-130 20 (5)

PU = Packaging Unit; SPU = Subpackaging Unit; Dimensions in mm









# WAGO PUSH WIRE® Splicing Connectors

## WAGO Luminaire Disconnect Connectors

## WAGO PUSH WIRE® Splicing Connectors

### WAGO Luminaire Disconnect Connectors

			Page
	<b>PUSH WIRE® Splicing Connectors</b> for solid conductors 2.5 mm² (16 AWG)	2273 Series	36
	<b>PUSH WIRE® Inline Splicing Connectors</b> for solid and stranded conductors 4 mm² (12 AWG)	2773 Series	38
	<b>PUSH WIRE® Splicing Connectors</b> for solid conductors 2.5 mm² (14 AWG) 4 mm² (12 AWG) 6 mm² (10 AWG)	773 Series	42 44 46
	<b>PUSH WIRE® Splicing Connectors - for higher Temperatures</b> for solid conductors 2.5 mm² (14 AWG)	773 Series	48
	<b>PUSH WIRE® Splicing Connectors - for Ex Applications</b> for solid and stranded conductors 2.5 mm² (14 AWG) 6 mm² (10 AWG)	773 Series	50 52
	<b>PUSH WIRE® Splicing Connectors</b> for solid conductors Ø 0,5 mm Ø 0,8 mm	243 Series	56 58
	<b>Luminaire Disconnect Connectors</b> for solid and stranded conductors 12 AWG	873 Series	60

## PUSH WIRE® Splicing connectors ▶ for solid conductors

### 2273 Series

#### Description and Installation



#### Advantages:

- Convenient wiring via extremely compact design
- Push-in termination of up to eight solid conductors
- Cross section range: 0.5 ... 2.5 mm<sup>2</sup> (18 ... 14 AWG)
- Any combination of conductor sizes is possible
- PUSH WIRE® connection terminates solid ("s") copper conductors



Strip solid conductor to 11 mm/0.43 inch (see marking).

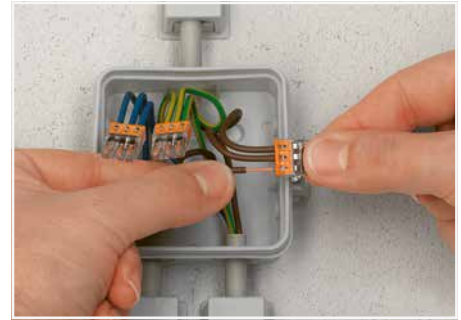

Termination: Insert the stripped solid conductor until it hits backstop.

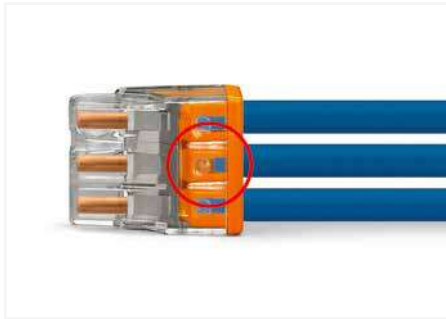

The transparent housing shows if conductors are fully inserted; within the colored base, a clear port shows if the conductor's strip length is correct.

Conductors are correctly stripped if the clear port shows no bare conductor on the unprinted connector side. Picture shows center conductor with exceeded strip length.



Removal: Hold conductor to be removed and twist alternately left and right while pulling the connector.



Testing via test port opposite to conductor entry.



One single carrier can hold up to 24 clamping units in a very narrow space. Previously, this was only possible using rail-mount terminal blocks.

#### Advantages:

- Mount carrier onto DIN-35 rail or via screws – easily and quickly
- Accommodate three 2.5 mm<sup>2</sup> (12 AWG) 2273 Series Connectors in a single carrier
- Easily exchange connectors
- Large marking area for self-adhesive marking strips or for direct marking with permanent felt-tip pen



To adjust the mounting carrier, unlock the latch via operating tool (5.5 mm blade) and move the clamping slide to the required width by rotating the tool.



The mounting carrier is suitable for both connector widths.

#### PUSH WIRE® Connectors in Distribution Boxes

During distribution box retrofits or expansions, connectors often require extensions or additional clamping points. Individual PUSH WIRE® connectors (e.g., 2273 Series) are approved as interconnect components for building wiring applications per EN 60998. Application standards for building installation (e.g., Parts 510 and 520 from DIN VDE 0100) also place the following requirements on junction box connectors:

- They must be arranged so that operation, inspection, maintenance and access to the removable connectors is simplified.
- It must be possible to test them.
- Conductors connected from outside must be clearly and permanently assigned to their associated circuits.

These requirements cannot be met with PUSH WIRE® connectors alone. In combination with mounting carriers, the PUSH WIRE® connectors clearly meet these requirements, making them comparable to rail-mount terminal blocks. Using PUSH WIRE® connectors with mounting carriers in distribution boxes is accepted by testing authorities.

# PUSH WIRE® Inline splicing connector ▶ for solid and stranded conductors

## 2773 Series

### Description and Installation

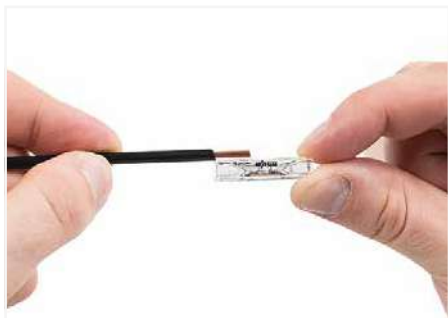

Strip conductor to 10 mm.



Insert the conductor.



Check for the correct conductor position.



Twist the connector alternately left and right while pulling it off the conductor.



2



Wiring conductors in a flush-mounted junction box.



Extending short wires.



Use with a shrink tube.

## PUSH WIRE® Splicing Connector ▶ 2273 Series ▶ Housing color: transparent ▶ 2.5 mm<sup>2</sup>



### • Advantages:

- Convenient wiring via extremely compact design
- Push-in termination of up to eight solid conductors
- Cross-section range: 0.5 ... 2.5 mm<sup>2</sup>
- Any combination of conductor sizes is possible
- PUSH WIRE® connection terminates solid ("s") copper conductors

### Electrical data

Ratings per	IEC/EN 60998		
Overvoltage category	III	III	II
Pollution degree	3	2	2
Nominal voltage	-	-	450 V
Rated surge voltage	-	-	4 kV
Rated current	-	-	24 A

### Connection data

Connection technology	PUSH WIRE®
Strip length	11 mm / 0.43 inches
Connectable conductor materials	Copper; Aluminum
Solid conductor	0.5 ... 2.5 mm <sup>2</sup> / 20 ... 16 AWG

### Material data

Material group	IIIa
Insulation material (main housing)	Polycarbonate (PC)
Flammability class per UL94	V2
Clamping spring material	Chrome-nickel spring steel (CrNi)
Contact material	Electrolytic copper (E <sub>Cu</sub> )
Contact Plating	Tin

### Environmental requirements

Continuous operating temperature	105 °C
Ambient temperature (operation)	+60 °C
Temperature marking per EN 60998	T60

**Note:**  
in grounded power lines

General accessories Page 65

Tool Page 112

See technical section for further information

Approvals and corresponding ratings, visit [www.wago.com](http://www.wago.com)

# PUSH WIRE® Splicing Connector ▶ 2273 Series ▶ Housing color: transparent ▶ 2.5 mm<sup>2</sup>

Clamping units: 2



Clamping units: 3



Clamping units: 4



2273-202

Cover color	Item No.	PU (SPU)
white	2273-202	1000 (100)

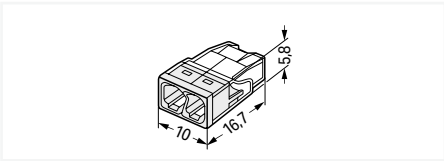

2273-203

Cover color	Item No.	PU (SPU)
orange	2273-203	1000 (100)

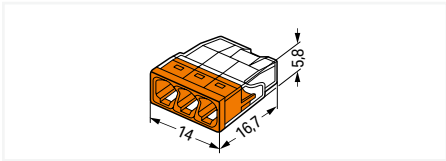

2273-204

Cover color	Item No.	PU (SPU)
red	2273-204	1000 (100)

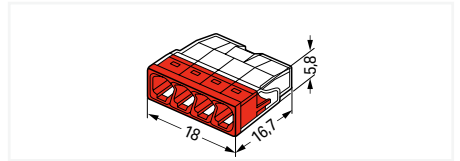

Clamping units: 5



Clamping units: 8



2273-205

Cover color	Item No.	PU (SPU)
yellow	2273-205	1000 (100)

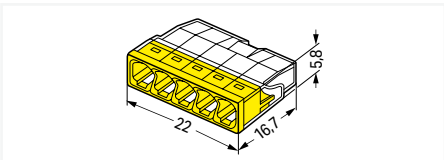

2273-208

Cover color	Item No.	PU (SPU)
light gray	2273-208	500 (50)

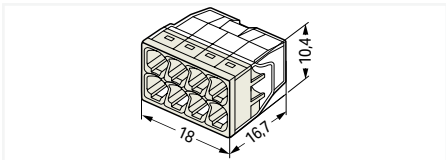

Accessories; for all products on this page



Mounting carrier; DIN-35 rail, Screw mount

Color	Item No.	PU (SPU)
orange	2273-500	50 (10)

PU = packaging unit; SPU = subpackaging unit; Dimensions in mm

## PUSH WIRE® Inline Splicing Connector ▶ 2773 Series ▶ 4 mm<sup>2</sup>



2

Electrical data			
<b>Ratings per</b>	EN 60664		
Overtoltage category	III	III	II
Pollution degree	3	2	2
Nominal voltage	-	-	450 V
Rated surge voltage	-	-	4 kV
Rated current	-	-	32 A
<b>Approvals per</b>	UL 486C		
Use group	B	C	D
Rated voltage	-	600 V	-
Rated current	-	20 A	-
Connection data			
Connection technology	PUSH WIRE®		
Strip length	10 ... 11 mm / 0.39 ... 0.43 inches		
Solid conductor	0.75 ... 4 mm <sup>2</sup> / 18 ... 12 AWG		
Stranded conductor	1.5 ... 4 mm <sup>2</sup>		
Fine-stranded conductor; with insulated ferrule	0.75 ... 1.5 mm <sup>2</sup> / 18 ... 16 AWG		
Fine-stranded conductor; with uninsulated ferrule	1 ... 1.5 mm <sup>2</sup> / 16 AWG		
Conductor diameter	1.6 ... 2 mm / 18 ... 12 AWG		
Material data			
Material group	IIIa		
Insulation material (main housing)	Polycarbonate (PC)		
Flammability class per UL94	V2		
Clamping spring material	Chrome-nickel spring steel (CrNi)		
Contact material	Electrolytic copper (E <sub>cu</sub> )		
Contact Plating	Tin		
Environmental requirements			
Processing temperature	-35 ... +60 °C		
Continuous operating temperature	105 °C		
Ambient temperature (operation)	+85 °C		

General accessories Page 73

See technical section for further information

Approvals and corresponding ratings, visit [www.wago.com](http://www.wago.com)

# PUSH WIRE® Inline Splicing Connector ▶ 2773 Series ▶ 4 mm<sup>2</sup>

Clamping units: 2



2773-2401

Cover color	Item No.	PU (SPU)
transparent	2773-2401	1000 (100)

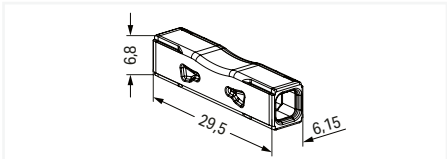

2

PU = packaging unit; SPU = subpackaging unit

# PUSH WIRE® Splicing connectors 773 Series Description and Installation

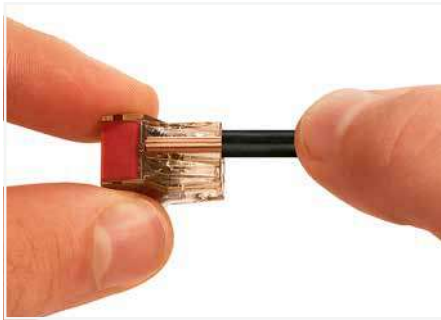
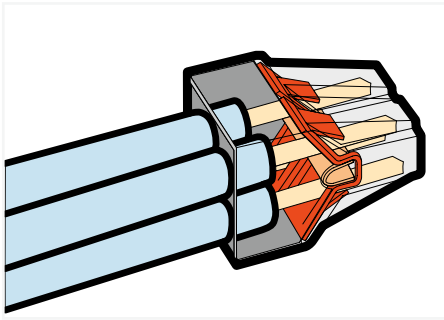

Strip a solid conductor to 12 mm (0.47 inch).



Termination: Insert stripped solid conductor until it hits backstop.

2



Removal: Hold conductor to be removed and twist alternately left and right while pulling the connector.

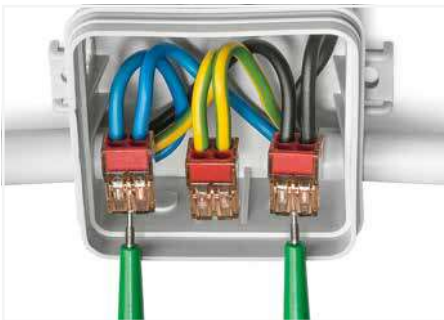

Testing





## PUSH WIRE® Splicing Connector ▶ 773 Series ▶ Housing color: transparent ▶ 2.5 mm<sup>2</sup>



Electrical data			
Ratings per	IEC/EN 60664-1		
Overvoltage category	III	III	II
Pollution degree	3	2	2
Nominal voltage	-	-	400 V
Rated surge voltage	-	-	4 kV
Rated current	-	-	24 A
Connection data			
Connection technology	PUSH WIRE®		
Strip length	12 mm / 0.47 inches		
Connectable conductor materials	Copper; Aluminum		
Solid conductor	0.75 ... 2.5 mm <sup>2</sup> / 18 ... 12 AWG		
Stranded conductor	1.5 ... 2.5 mm <sup>2</sup> / 16 ... 12 AWG		
Material data			
Material group	IIIa		
Insulation material (main housing)	Polycarbonate (PC)		
Flammability class per UL94	V2		
Clamping spring material	Chrome-nickel spring steel (CrNi)		
Contact material	Electrolytic copper (E <sub>cu</sub> )		
Contact Plating	Tin		
Environmental requirements			
Continuous operating temperature	105 °C		
Ambient temperature (operation)	+60 °C		

**Note:**  
in grounded power lines

Mounting adapter Page 102

Tool Page 112

See technical section for further information

Approvals and corresponding ratings, visit [www.wago.com](http://www.wago.com)

# PUSH WIRE® Splicing Connector ▶ 773 Series ▶ Housing color: transparent ▶ 2.5 mm<sup>2</sup>

Clamping units: 2



Clamping units: 4



Clamping units: 6



773-102

Cover color	Item No.	PU (SPU)
yellow	773-102	1000 (100)
green	773-112	1000 (100)

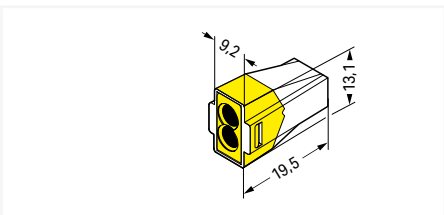

773-104

Cover color	Item No.	PU (SPU)
orange	773-104	1000 (100)
light gray	773-124	1000 (100)

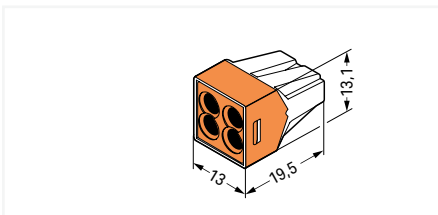

773-106

Cover color	Item No.	PU (SPU)
violet	773-106	500 (50)
green	773-116	500 (50)

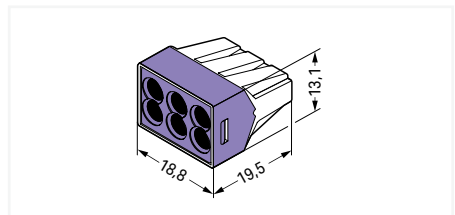

Clamping units: 8



773-108

Cover color	Item No.	PU (SPU)
dark gray	773-108	500 (50)
green	773-118	500 (50)

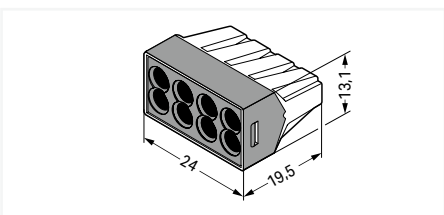

### Accessories; for all products on this page



Mounting carrier; DIN-35 rail, Screw mount

Color	Item No.	PU (SPU)
orange	773-332	50 (10)

PU = packaging unit; SPU = subpackaging unit; Dimensions in mm

## PUSH WIRE® Splicing Connector ▶ 773 Series ▶ Housing color: transparent brown ▶ 4 mm<sup>2</sup>



### Electrical data

Ratings per	IEC/EN 60664-1		
Overvoltage category	III	III	II
Pollution degree	3	2	2
Nominal voltage	-	-	400 V
Rated surge voltage	-	-	4 kV
Rated current	-	-	32 A

### Connection data

Connection technology	PUSH WIRE®
Strip length	12 mm / 0.47 inches
Connectable conductor materials	Copper; Aluminum
Solid conductor	1.5 ... 4 mm <sup>2</sup> / 20 ... 12 AWG

### Material data

Flammability class per UL94	V2
Clamping spring material	Chrome-nickel spring steel (CrNi)
Contact material	Electrolytic copper (E <sub>cu</sub> )
Contact Plating	Tin

### Environmental requirements

Continuous operating temperature	105 °C
Ambient temperature (operation)	+60 °C

Tool Page 112

See technical section for further information

Approvals and corresponding ratings, visit [www.wago.com](http://www.wago.com)

# PUSH WIRE® Splicing Connector ▶ 773 Series ▶ Housing color: transparent brown ▶ 4 mm<sup>2</sup>

Clamping units: 2



Clamping units: 4



Clamping units: 6



773-602

Cover color	Item No.	PU (SPU)
white	773-602	1000 (100)

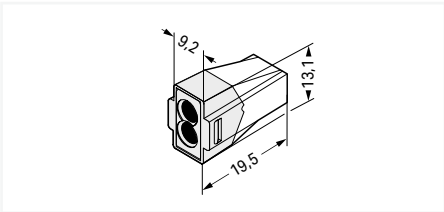

773-604

Cover color	Item No.	PU (SPU)
red	773-604	1000 (100)

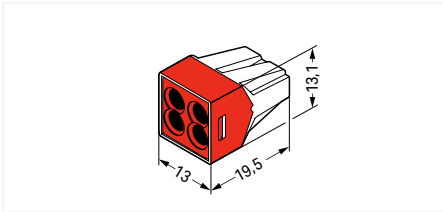

773-606

Cover color	Item No.	PU (SPU)
brown	773-606	500 (50)

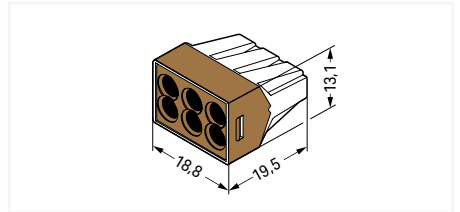

2

### Accessories; for all products on this page



Mounting carrier; DIN-35 rail, Screw mount

Color	Item No.	PU (SPU)
orange	773-332	50 (10)

PU = packaging unit; SPU = subpackaging unit; Dimensions in mm

## PUSH WIRE® Splicing Connector ▶ 773 Series ▶ Housing color: transparent ▶ 6 mm<sup>2</sup>



### Electrical data

Ratings per	IEC/EN 60664-1		
Overvoltage category	III	III	II
Pollution degree	3	2	2
Nominal voltage	-	-	400 V
Rated surge voltage	-	-	4 kV
Rated current	-	-	41 A

### Connection data

Connection technology	PUSH WIRE®
Strip length	12 ... 13 mm / 0.47 ... 0.51 inches
Connectable conductor materials	Copper; Aluminum
Solid conductor	2.5 ... 6 mm <sup>2</sup> / 14 ... 10 AWG
Stranded conductor	2.5 ... 6 mm <sup>2</sup> / 14 ... 10 AWG

### Material data

Material group	IIIa
Insulation material (main housing)	Polycarbonate (PC)
Flammability class per UL94	V2
Clamping spring material	Chrome-nickel spring steel (CrNi)
Contact material	Electrolytic copper (E <sub>cu</sub> )
Contact Plating	Tin

### Environmental requirements

Continuous operating temperature	105 °C
Ambient temperature (operation)	+60 °C

**Note:**  
in grounded power lines

Tool Page 112

See technical section for further information

Approvals and corresponding ratings, visit [www.wago.com](http://www.wago.com)

# PUSH WIRE® Splicing Connector ▶ 773 Series ▶ Housing color: transparent ▶ 6 mm<sup>2</sup>

Clamping units: 3



773-173

Cover color	Item No.	PU (SPU)
red	773-173	500 (50)

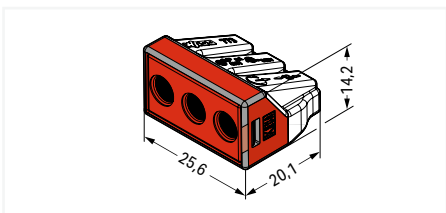

2

## Accessories; for all products on this page



Mounting carrier; DIN-35 rail, Screw mount

Color	Item No.	PU (SPU)
orange	773-332	50 (10)

PU = packaging unit; SPU = subpackaging unit; Dimensions in mm

## PUSH WIRE® Splicing Connector ▶ 773 Series ▶ Housing color: black ▶ 2.5 mm<sup>2</sup>



### Electrical data

Ratings per	IEC/EN 60664-1		
Overvoltage category	III	III	II
Pollution degree	3	2	2
Nominal voltage	-	-	400 V
Rated surge voltage	-	-	4 kV
Rated current	-	-	24 A

### Connection data

Connection technology	PUSH WIRE®
Strip length	12 mm / 0.47 inches
Connectable conductor materials	Copper; Aluminum
Solid conductor	0.75 ... 2.5 mm <sup>2</sup> / 18 ... 12 AWG
Stranded conductor	1.5 ... 2.5 mm <sup>2</sup> / 16 ... 12 AWG

### Material data

Insulation material (main housing)	Polyamide (PA46)
Flammability class per UL94	V2
Clamping spring material	Chrome-nickel spring steel (CrNi)
Contact material	Electrolytic copper (E <sub>cu</sub> )
Contact Plating	Tin

### Environmental requirements

Continuous operating temperature	150 °C
Ambient temperature (operation)	+60 °C

**Note:**  
in grounded power lines

Tool Page 112

See technical section for further information

Approvals and corresponding ratings, visit [www.wago.com](http://www.wago.com)

PUSH WIRE® Splicing Connector ▶ 773 Series ▶ Housing color: black ▶ 2.5 mm<sup>2</sup>

Clamping units: 4



773-514

Cover color	Item No.	PU
black	773-514	100

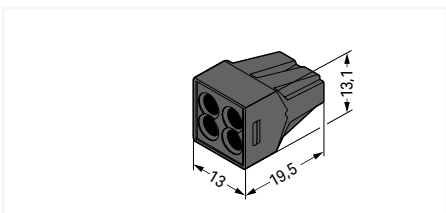

2

Accessories; for all products on this page



Mounting carrier; DIN-35 rail, Screw mount

Color	Item No.	PU (SPU)
orange	773-332	50 (10)

PU = packaging unit; SPU = subpackaging unit; Dimensions in mm

## PUSH WIRE® Splicing Connector ▶ 773 Series ▶ Housing color: light gray ▶ 2.5 mm<sup>2</sup>



2

Electrical data	
Rated voltage EN (Ex e II)	550 V
Rated current (Ex e II)	24 A
Connection data	
Connection technology	PUSH WIRE®
Strip length	12 mm / 0.47 inches
Connectable conductor materials	Copper
Solid conductor	0.75 ... 2.5 mm <sup>2</sup> / 18 ... 14 AWG
Stranded conductor	0.75 ... 2.5 mm <sup>2</sup> / 16 ... 12 AWG
Material data	
Flammability class per UL94	V2
Clamping spring material	Chrome-nickel spring steel (CrNi)
Contact material	Electrolytic copper (E <sub>cu</sub> )
Contact Plating	Tin
Environmental requirements	
Continuous operating temperature	105 °C
Ambient temperature (operation)	+60 °C

**Note:**  
To be used only in conjunction with a mounting carrier (773-331).

See technical section for further information

Approvals and corresponding ratings, visit [www.wago.com](http://www.wago.com)

# PUSH WIRE® Splicing Connector ▶ 773 Series ▶ Housing color: light gray ▶ 2.5 mm<sup>2</sup>

Clamping units: 2



773-492

Cover color	Item No.	PU (SPU)
light gray	773-492	1000 (100)

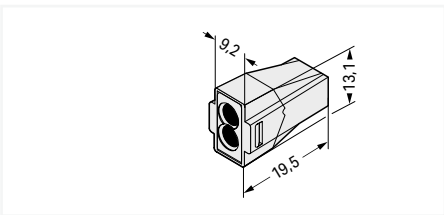

Clamping units: 4



773-494

Cover color	Item No.	PU (SPU)
light gray	773-494	1000 (100)

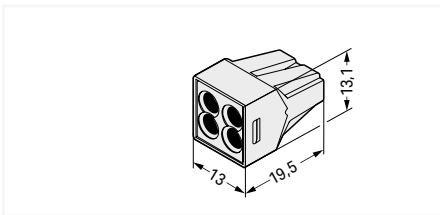

Clamping units: 6



773-496

Cover color	Item No.	PU (SPU)
light gray	773-496	500 (50)

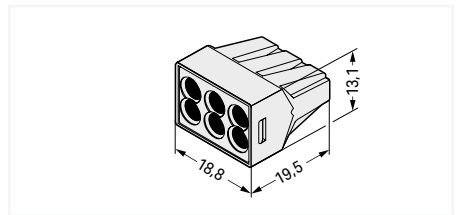

Clamping units: 8



773-498

Cover color	Item No.	PU (SPU)
light gray	773-498	500 (50)

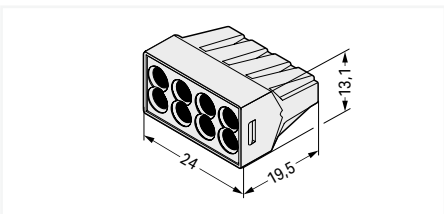

## Accessories; for all products on this page



Mounting carrier; DIN-35 rail, Screw mount

Color	Item No.	PU (SPU)
○ light gray	773-331	50 (10)

PU = packaging unit; SPU = subpackaging unit; Dimensions in mm

## PUSH WIRE® Splicing Connector ▶ 773 Series ▶ Housing color: light gray ▶ 6 mm<sup>2</sup>



### Electrical data

Rated voltage EN (Ex e II)	550 V
Rated current (Ex e II)	42 A

### Connection data

Connection technology	PUSH WIRE®
Strip length	12 ... 15 mm / 0.47 ... 0.59 inches
Connectable conductor materials	Copper
Solid conductor	2.5 ... 6 mm <sup>2</sup> / 14 ... 10 AWG
Stranded conductor	2.5 ... 6 mm <sup>2</sup> / 14 ... 10 AWG

### Material data

Flammability class per UL94	V2
Clamping spring material	Chrome-nickel spring steel (CrNi)
Contact material	Electrolytic copper (E <sub>cu</sub> )
Contact Plating	Tin

### Environmental requirements

Continuous operating temperature	105 °C
Ambient temperature (operation)	+60 °C

#### Note:

To be used only in conjunction with a mounting carrier (773-331).

See technical section for further information

Approvals and corresponding ratings, visit [www.wago.com](http://www.wago.com)

# PUSH WIRE® Splicing Connector ▶ 773 Series ▶ Housing color: light gray ▶ 6 mm<sup>2</sup>

Clamping units: 3



773-493

Cover color	Item No.	PU (SPU)
light gray	773-493	500 (50)

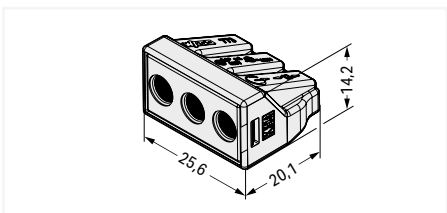

2

## Accessories; for all products on this page



Mounting carrier; DIN-35 rail, Screw mount

Color	Item No.	PU (SPU)
○ light gray	773-331	50 (10)

PU = packaging unit; SPU = subpackaging unit; Dimensions in mm

# PUSH WIRE® Splicing connectors ▶ for solid conductors

## 243 Series

### Description and Installation

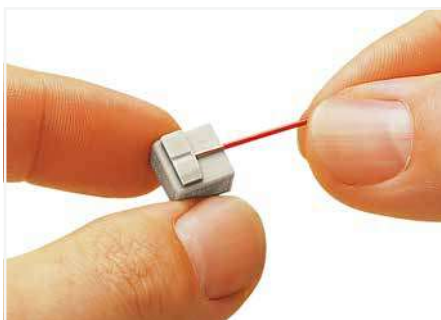
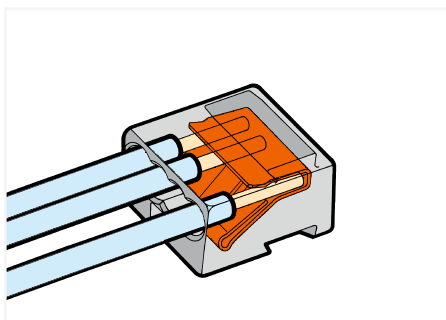

Strip solid conductors to 5 ... 6 mm (0.19 ... 0.23 inch).



Connector strips:  
Assembling modular connectors into connector strips.

2

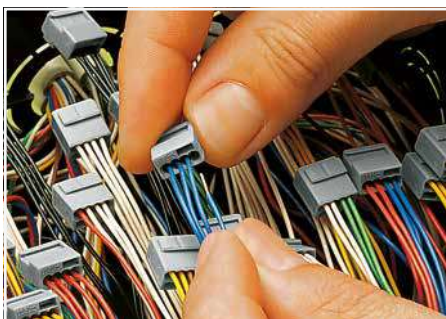

Termination: Insert stripped conductor until it hits back-stop.

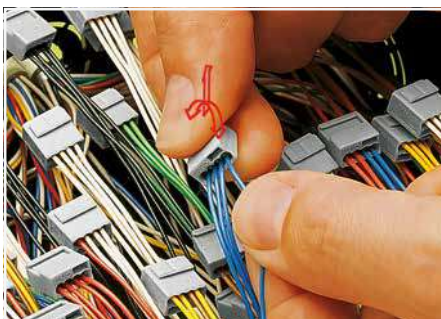

Removal: Hold conductor to be removed and twist alternately left and right while pulling the connector.



Testing



Commoned connector strips

## Mounting Carrier ▶ for PUSH WIRE® Splicing connectors ▶ for DIN-35 Rail or Screw Mount 243 Series

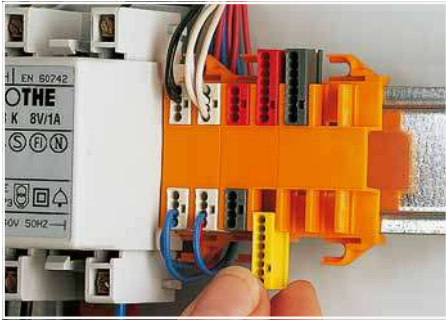

Inserting a MICRO junction box connector into the mounting carrier.

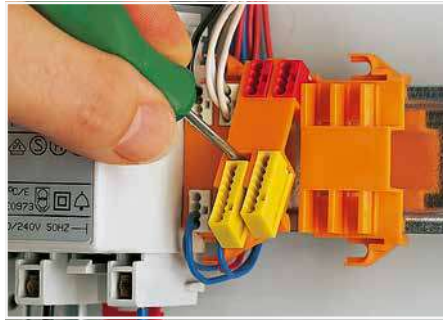

Removing a mounting carrier from the assembly.



Example of a residential door bell application – carriers mounted on a DIN-35 rail

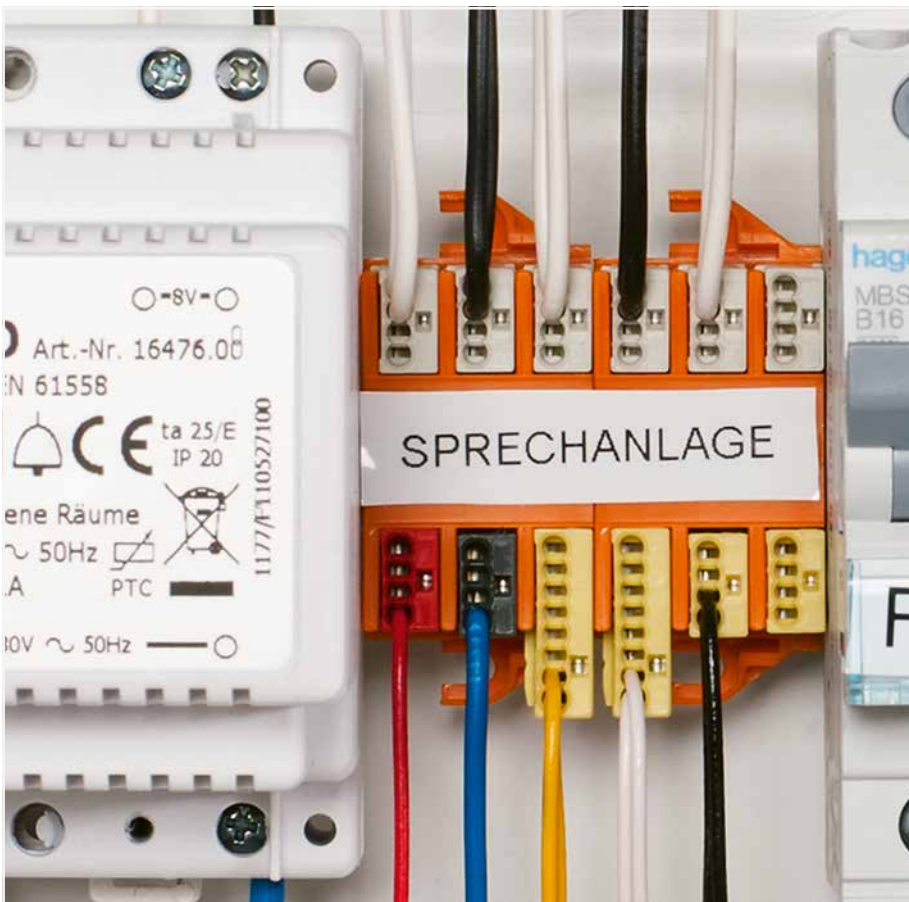

Example of a residential intercom application

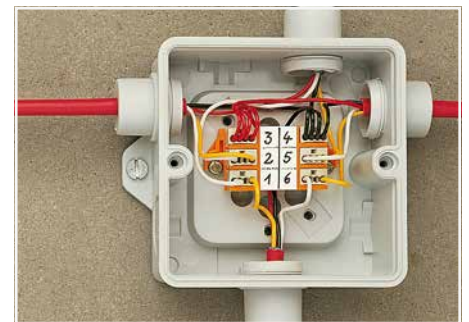

Typical application in a terminal box for burglar alarm – screw-mounted carrier

### Quick Fix Mounting

Realizing MICRO PUSH WIRE® connectors for junction boxes are ideal for DIN-rail-mount panel applications, electrical installers have requested the ability to use them in distribution panels. These connectors provide easy connections for smaller conductors used in low-current applications. They are well-suited to terminating telephone-style conductors for connecting alarms, bells, door sensors, communication systems, etc.

The mounting carrier is WAGO's professional solution. It is available with mounting slots for 4 or 6 connectors.

Depending on the number of conductors, each mounting slot can accommodate a 4- or 8-conductor MICRO PUSH WIRE® junction box connector. The connectors simply snap into the mounting slots and are removable, allowing conductors to be exchanged during changeover.

The carrier is designed for easy mounting directly to the DIN-35 rail, or to a panel, via the screw-mount flanges provided on both sides. A large marking area for direct marking with a permanent felt-tip pen or for pre-printed self-adhesive marking strips is provided for clear circuit identification.

## PUSH WIRE® Splicing Connector ▶ 243 Series ▶ Conductor diameter: 0.4 ... 0.5 mm / 26 ... 24 AWG

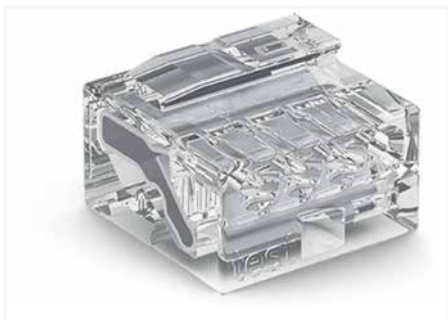

2

Electrical data			
Ratings per	EN 60664		
Overvoltage category	III	III	II
Pollution degree	3	2	2
Nominal voltage	-	-	100 V
Rated surge voltage	-	-	1.5 kV
Rated current	-	-	6 A
Connection data			
Connection technology	PUSH WIRE®		
Strip length	5 ... 6 mm / 0.2 ... 0.24 inches		
Connectable conductor materials	Copper		
Solid conductor	26 ... 24 AWG		
Conductor diameter	0.4 ... 0.5 mm / 26 ... 24 AWG		
Material data			
Material group	IIIa		
Insulation material (main housing)	Polycarbonate (PC)		
Flammability class per UL94	V2		
Environmental requirements			
Continuous operating temperature	105 °C		
Ambient temperature (operation)	+60 °C		

See technical section for further information

Approvals and corresponding ratings, visit [www.wago.com](http://www.wago.com)

# PUSH WIRE® Splicing Connector ▶ 243 Series ▶ Conductor diameter: 0.4 ... 0.5 mm / 26 ... 24 AWG

Clamping units: 4



243-144

Color	Item No.	PU (SPU)
○ transparent	243-144	1000 (100)

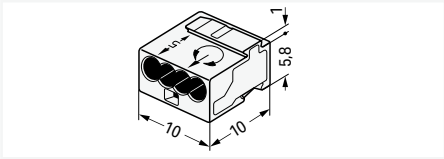

2

Accessories; for all products on this page



Mounting carrier; DIN-35 rail, Screw mount

Suitable	Item No.	PU (SPU)
for 4 connectors	243-112	50 (10)
for 6 connectors	243-113	50 (10)

PU = packaging unit; SPU = subpackaging unit; Dimensions in mm

## PUSH WIRE® Splicing Connector ▶ 243 Series ▶ Conductor diameter: 0.6 ... 0.8 mm / 22 ... 20 AWG



Electrical data			
Ratings per	EN 60664		
Overvoltage category	III	III	II
Pollution degree	3	2	2
Nominal voltage	-	-	100 V
Rated surge voltage	-	-	1.5 kV
Rated current	-	-	6 A
Connection data			
Connection technology	PUSH WIRE®		
Strip length	5 ... 6 mm / 0.2 ... 0.24 inches		
Connectable conductor materials	Copper		
Solid conductor	22 ... 20 AWG		
Conductor diameter	0.6 ... 0.8 mm / 22 ... 20 AWG		
Conductor diameter (note)	When using conductors of the same diameter, 0.5 mm (24 AWG) or 1 mm (18 AWG) diameters are also possible.		
Environmental requirements			
Continuous operating temperature	105 °C		
Ambient temperature (operation)	+60 °C		

See technical section for further information

Approvals and corresponding ratings, visit [www.wago.com](http://www.wago.com)

# PUSH WIRE® Splicing Connector ▶ 243 Series ▶ Conductor diameter: 0.6 ... 0.8 mm / 22 ... 20 AWG

Clamping units: 4

Clamping units: 8



243-204

Color	Item No.	PU (SPU)
● dark gray	243-204	1000 (100)
○ light gray	243-304	1000 (100)
● yellow	243-504	1000 (100)
● red	243-804	1000 (100)

243-208

Color	Item No.	PU (SPU)
● dark gray	243-208	500 (50)
○ light gray	243-308	500 (50)
● yellow	243-508	500 (50)
● red	243-808	500 (50)

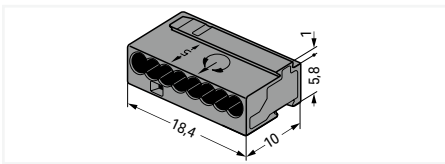
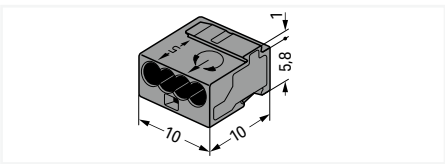

2

Accessories; for all products on this page



Mounting carrier; DIN-35 rail, Screw mount

Suitable	Item No.	PU (SPU)
for 4 connectors	243-112	50 (10)
for 6 connectors	243-113	50 (10)

PU = packaging unit; SPU = subpackaging unit; Dimensions in mm

# Luminaire Disconnect Connector (U.S. Version) 12 AWG; 873 Series

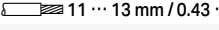
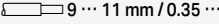
Technical Data	
2-conductor plug ①	1-conductor socket ②
18 ... 12 AWG "s"	18 AWG "s"
16 ... 12 AWG "st"	600 V, 6 A
 11 ... 13 mm / 0.43 ... 0.51 inch ①	
 9 ... 11 mm / 0.35 ... 0.43 inch ②	

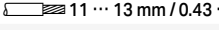
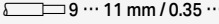
Technical Data	
2-conductor plug ①	1-conductor socket ②
18 ... 12 AWG "s"	18 AWG "s"
16 ... 12 AWG "st"	600 V, 6 A
 11 ... 13 mm / 0.43 ... 0.51 inch ①	
 9 ... 11 mm / 0.35 ... 0.43 inch ②	

- ① 2-conductor plug
  - ② 1-conductor socket
- Approvals and corresponding ratings, visit [www.wago.com](http://www.wago.com)

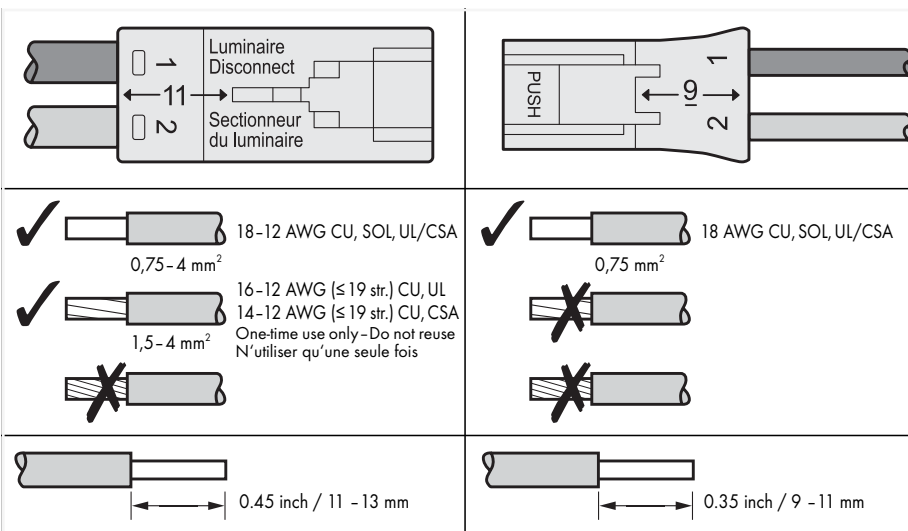
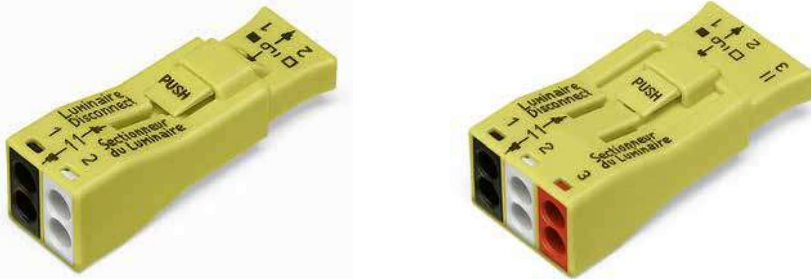

Touchproof connectors are required for ballast supply cables in the USA and Canada. When exchanging a ballast:

1. The touch-proof plug-in connection is disconnected first.
2. The ballast is replaced.
3. Network connection is restored by plugging the connection.

Reconnection streamlines ballast replacement while enhancing safety by safeguarding the installer from electric shock. The 873 Series is approved according to UL 2459 and CSA 22.2 for this type of application.

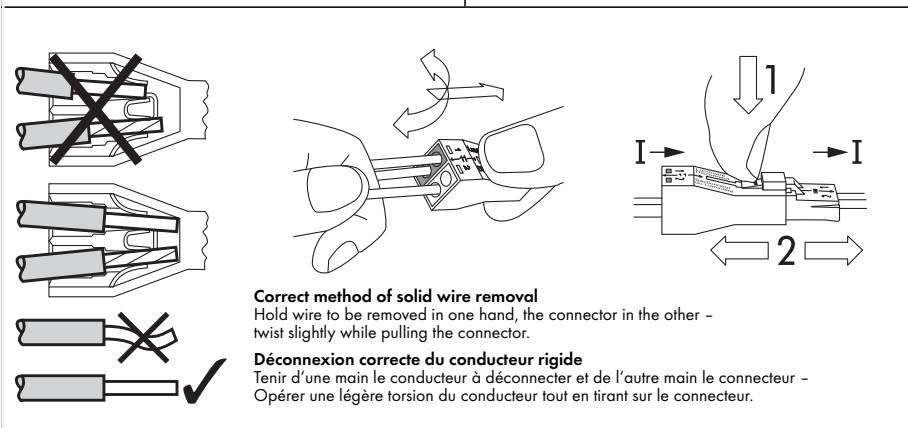

873 Series approvals per EN 60998 and EN 61984:

EN 60998  
0.75 mm<sup>2</sup> (solid), 6 A for socket  
1.5 ... 4 mm<sup>2</sup> (solid), 32 A for plug  
400 V / 4 kV / 2



EN 61984  
0.75 mm<sup>2</sup> (solid), 6 A for socket  
0.75 ... 4 mm<sup>2</sup> (solid), 32 A for plug  
400 V / 4 kV / 2

Luminaire Disconnect Connectors		
Pole No.	Item No.	Pack. Unit
2	873-902	400

Luminaire Disconnect Connectors		
Pole No.	Item No.	Pack. Unit
3	873-903	200

# Luminaire Disconnect Connector (U.S. Version) 12 AWG; 873 Series

### Technical Data

2-conductor plug ❶	1-conductor socket ❷
18 ... 12 AWG "s"	18 AWG "s"
16 ... 12 AWG "st"	600 V, 6 A
 11 ... 13 mm / 0.43 ... 0.51 inch ❶	
 9 ... 11 mm / 0.35 ... 0.43 inch ❷	



- ❶ 2-conductor plug
  - ❷ 1-conductor socket
- Approvals and corresponding ratings, visit [www.wago.com](http://www.wago.com)

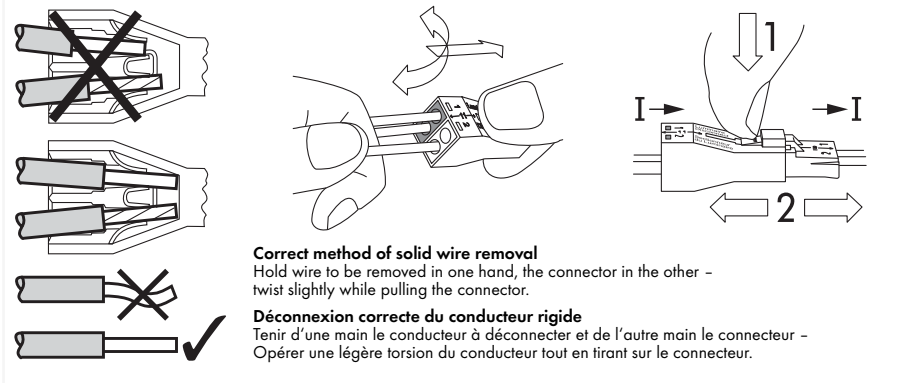
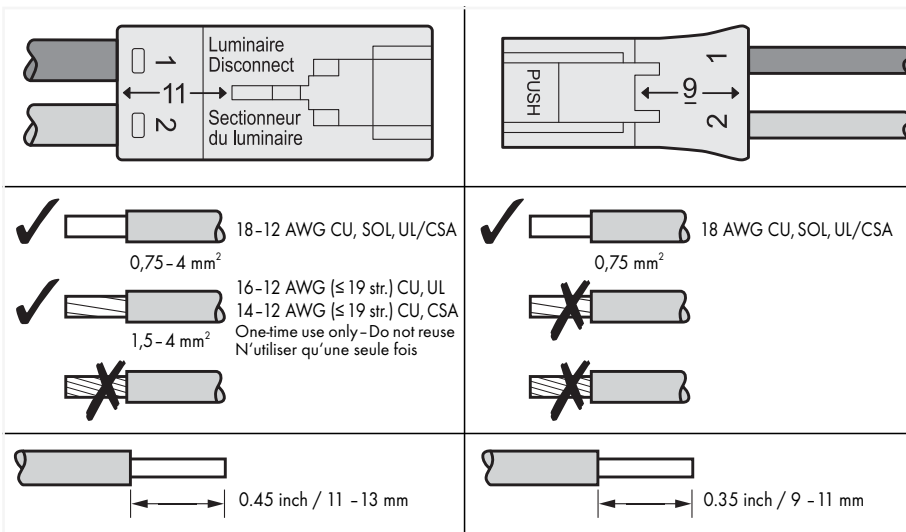

Luminaire disconnect connector; with preceding ground contact		
Pole No.	Item No.	Pack. Unit
2	873-953	500

Touchproof connectors are required for ballast supply cables in the USA and Canada. When exchanging a ballast:

1. The touch-proof plug-in connection is disconnected first.
2. The ballast is replaced.
3. Network connection is restored by plugging the connection.

Reconnection streamlines ballast replacement while enhancing safety by safeguarding the installer from electric shock. The 873 Series is approved according to UL 2459 and CSA 22.2 for this type of application.

873 Series approvals per EN 60998 and EN 61984:



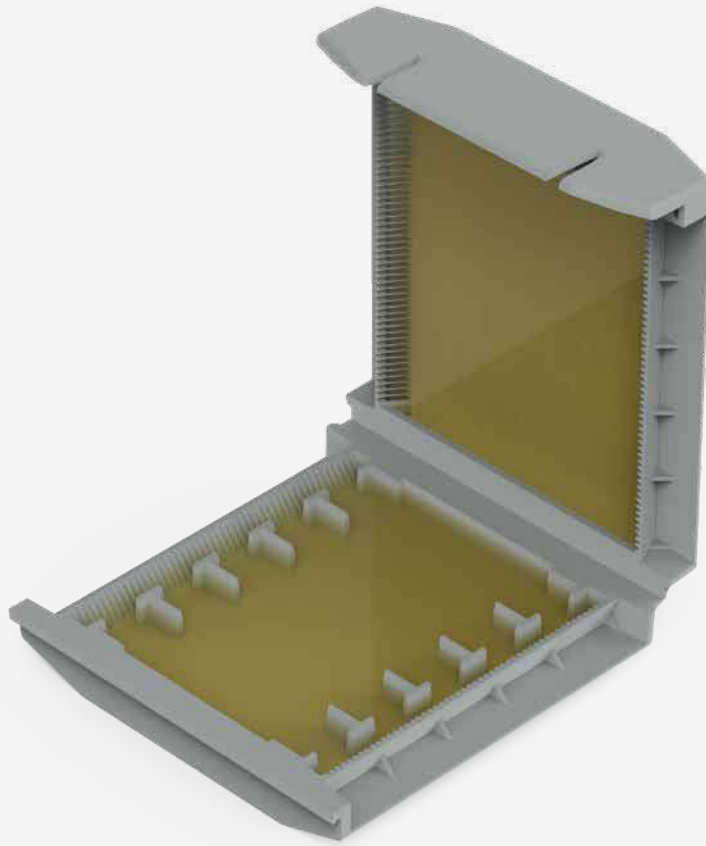

EN 60998  
0.75 mm<sup>2</sup> (solid), 6 A for socket  
1.5 ... 4 mm<sup>2</sup> (solid), 32 A for plug  
400 V / 4 kV / 2

EN 61984  
0.75 mm<sup>2</sup> (solid), 6 A for socket  
0.75 ... 4 mm<sup>2</sup> (solid), 32 A for plug  
400 V / 4 kV / 2

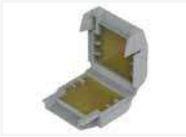

# WAGO Gelboxes / Junction Box / Cable Repair Set

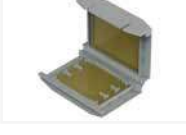
## WAGO Gelboxes / Junction Box / Cable Repair Set

			Page
	<b>Gelbox for splicing connectors</b> 4 mm <sup>2</sup>	207 Series	65
	<b>Gelbox for splicing connectors</b> 6 mm <sup>2</sup>	207 Series	66
	<b>Gelbox for inline splicing connectors</b> 4 mm <sup>2</sup>	207 Series	69
	<b>Junction box for splicing connectors 221 series</b> 4 mm <sup>2</sup>	207 Series	71
	<b>Cable repair set</b> 4 mm <sup>2</sup>	207 Series	73

# Gelboxes ▶ for Splicing Connectors 207 Series Installation



Open the Gelbox at the side latches.



Place the wired connector in the Gelbox.



Close the Gelbox.



Close latch securely and press down in the center.



Re-accessible:  
Open the Gelbox, remove the gel, open the connector and rewire with new components.



For low voltage applications > 50 V, use the Gelbox in a junction box.



Connecting a bollard light



Opened Gelbox with connector

3

## Gelbox ▶ for Splicing Connectors 2.5 mm<sup>2</sup> and 4 mm<sup>2</sup> 207 Series

### Technical Data

Housing material: Polypropylene

Gel material: Polyurethane

Voltage range: see connector voltage

Rated current: see connector current

Rated surge voltage: 2.5 kV

Insulation resistance: 5 MΩ

Surrounding air temperature (operation): -55 ... 85 °C

Surrounding air temperature (storage): 0 ... 40 °C

Physical properties: IPX8

Suitable for indefinite storage because the gel is free of hazardous substance according to CLP

Disposal: Household waste (residual waste)

Skin contact: After skin contact, clean with water; no special cleaning agent required

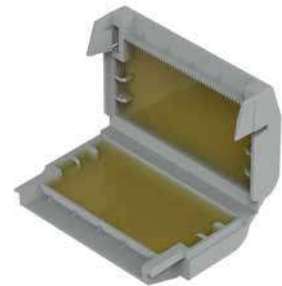

Gelbox; for conductors; branch; with gel; 221, 2273 Series; without splicing connectors; size 1

Color	Item No.	Pack. Unit
○ gray	207-1331	48 (4)

Gelbox; for conductors; branch; with gel; 221, 2273 Series; without splicing connectors; size 2

Color	Item No.	Pack. Unit
○ gray	207-1332	48 (4)

Gelbox; for conductors; branch; with gel; 221, 2273 Series; without splicing connectors; size 3

Color	Item No.	Pack. Unit
○ gray	207-1333	36 (3)

### Permitted Combinations of Connectors and Gelbox:

Item No.	221-412	221-413	221-415	221-612	221-613	221-615	2273-202	2273-203	2273-204	2273-208
207-1331	1 x	1 x	-				2 x	-	1 x	1 x
207-1332	2 x	-	1 x				3 x	2 x	-	1 x
207-1333	3 x	2 x	-				4 x	-	2 x	2 x

Note: With other combinations, the high degree of protection cannot be guaranteed because the gel displacement is too limited or the Gel Boxes can no longer be closed.

## Gelboxes ▶ for Splicing Connectors 6 mm<sup>2</sup>

### 207 Series

### Installation

#### Technical Data

Housing material: Polypropylene

Gel material: Polyurethane

Voltage range: see connector voltage

Rated current: see connector current

Rated surge voltage: 2.5 kV

Insulation resistance: 5 MΩ

Surrounding air temperature (operation): -55 ... 85 °C

Surrounding air temperature (storage): 0 ... 40 °C

Physical properties: IPX8

Suitable for indefinite storage because the gel is free of hazardous substance according to CLP

Disposal: Household waste (residual waste)

Skin contact: After skin contact, clean with water; no special cleaning agent required

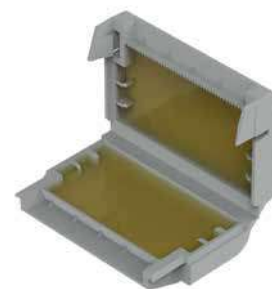
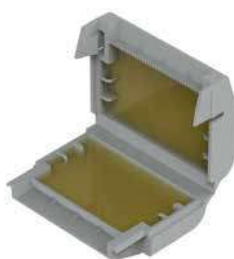

Gelbox; for conductors; branch; with gel; 221 Series, max. 6 mm<sup>2</sup> connectors; without splicing connectors; size 1

Color	Item No.	Pack. Unit
○ gray	207-1431	48 (4)

Gelbox; for conductors; branch; with gel; 221 Series, max. 6 mm<sup>2</sup> connectors; without splicing connectors; size 2

Color	Item No.	Pack. Unit
○ gray	207-1432	36 (3)

Gelbox; for conductors; branch; with gel; 221 Series, max. 6 mm<sup>2</sup> connectors; without splicing connectors; size 3

Color	Item No.	Pack. Unit
○ gray	207-1433	24 (2)

#### Permitted Combinations of Connectors and Gelbox:

Item Number	221-612	221-613	221-615	221-622	221-623	221-625
207-1431	1 x	1 x	-	1 x	1 x	-
207-1432	2 x	-	1 x	2 x	-	1 x
207-1433	3 x	2 x	-	3 x	2 x	-

Note: With other combinations, the high degree of protection cannot be guaranteed because the gel displacement is too limited or the Gel Boxes can no longer be closed.



# Gelboxes ▶ for 221 Series Inline Splicing Connectors 207 Series Installation



Open the Gelbox at the side latches.



Place the wired connector in the Gelbox.



Close the Gelbox.



Close latch securely.



Re-accessible:  
Open the Gelbox, remove the gel, open the connector and rewire with new components.

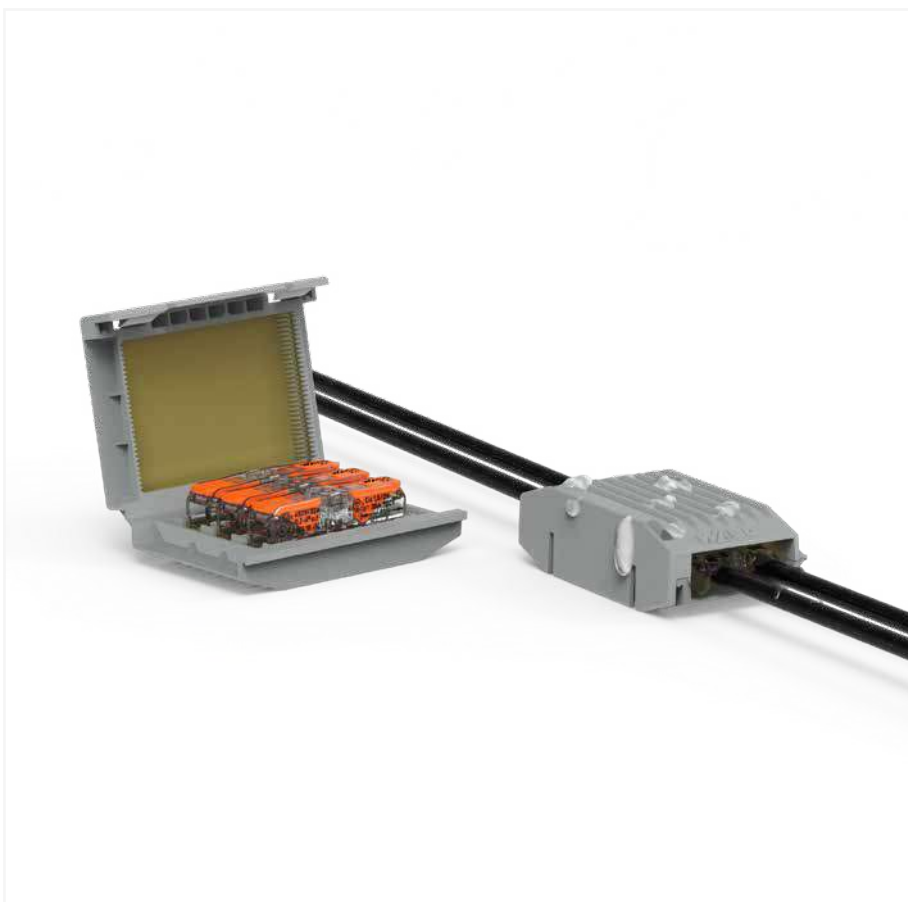

For low voltage applications > 50 V, use the Gelbox in a junction box.



Connecting a path light



Opened Gelbox with connector

3

## Gelbox ▶ for 221 Series Inline Splicing Connectors

### 207 Series

#### Technical Data

Housing material: Polypropylene

Gel material: Polyurethane

Voltage range: see connector voltage

Rated current: see connector current

Rated surge voltage: 2.5 kV

Insulation resistance: 5 MΩ

Ambient temperature (operation): -55 ... 85 °C

Ambient temperature (storage): 0 ... 40 °C

Physical properties: IPX8

Gel is suitable for indefinite storage, free of hazardous substances according to CLP

Disposal: Household waste (residual waste)

After skin contact: Clean with water, no special cleaning agents necessary

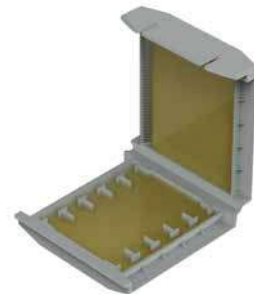
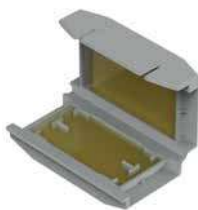

Gelbox; inline connection; for conductors; with gel; 221 Series, max. 4 mm<sup>2</sup> connectors; without splicing connectors; size 1

Color	Item No.	Pack. Unit
○ gray	207-1372	28 (4)

Gelbox; inline connection; for conductors; with gel; 221 Series, max. 4 mm<sup>2</sup> connectors; without splicing connectors; size 2

Color	Item No.	Pack. Unit
○ gray	207-1373	28 (4)

Gelbox; inline connection; for conductors; with gel; 221 Series, max. 4 mm<sup>2</sup> connectors; without splicing connectors; size 3

Color	Item No.	Pack. Unit
○ gray	207-1375	14 (2)

#### Permitted Combinations of Connectors and Gelbox:

Item Number	221-2411	221-2401	221-2431	221-2411
207-1372	2 x	2 x	2 x	2 x
207-1373	3 x	3 x	3 x	3 x
207-1375	5 x	5 x	5 x	5 x

Note: With other combinations, the high degree of protection cannot be guaranteed because the gel displacement is too limited or the Gelboxes can no longer be closed.

## Junction Boxes ▶ for 221 Series Splicing Connectors (4 mm<sup>2</sup>) 207 Series Installation



The junction box is designed for surface screw mounting on the wall/ceiling. The cover can be snapped on and off without screws. The connectors are easily mounted by snapping them in, and the marking strips are mounted by simply pushing them in.



Snap the connector into the holder.



Release the connector from the holder.

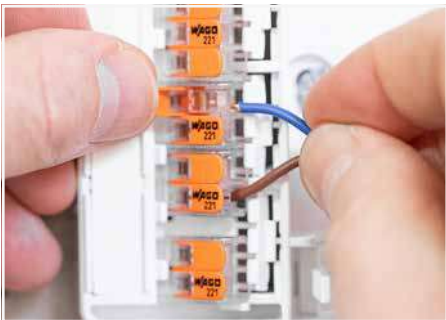

Inserting a conductor



Snap the marking strips into the holder.



Insert the cable into the strain relief. The snap-in strain reliefs are designed for cable diameters from 4 mm to 11 mm.



Break the cable entry lid out of the cover.



Snap on the junction box cover.



Open the junction box cover.

## Junction Box ▶ for 221 Series Splicing Connectors (4 mm<sup>2</sup>) 207 Series

### Technical Data

Dimensions (width x height x depth): 225 x 46 x 145 mm

Protection type: IP20

Current supply: 18 A (max.)

Operating voltage: 450 V (max.)

DEKRA test report per EN and BS 60670-22

Designed for up to 60 connection points



Junction box; for 221 Series splicing connectors – 4 mm<sup>2</sup>  
(221-41x, not included in delivery)

Color	Item No.	Pack. Unit
○ white	207-4301	1

### Accessories; 207 Series

Accessory set; consists of 6 double-deck strain reliefs  
and marking strips



207-9301 1

## Cable repair set 207 Series Installation



Damaged cable.

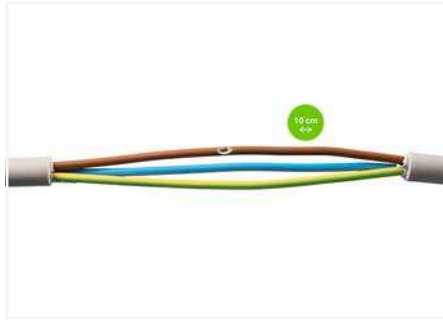

Strip the damaged cable approx. 10 cm uniformly around the damaged area.



Cut out the damaged areas in the copper and disconnect all other conductors. For damaged areas between 1 mm and 30 mm, at least 30 mm of the damaged conductor must be removed. Tip: A connector (approx. 30 mm long) can be used as a length guide.



As an alternative to step 5: Strip 10 mm of conductor according to specification and set the connector (example shows staggered connectors).



Strip 10 mm conductor per specification and insert connector (example shows staggered connectors).

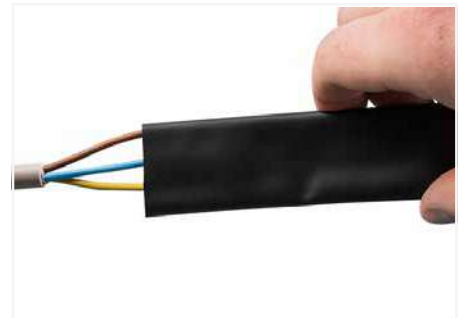

Pull the shrink tube over the cable end.



Heat the shrink tube evenly with a hot air blower between 110°C and 200°C.



The shrinking process is only completed when the shrink tube is tightly connected to the cable and the adhesive has visibly melted (see photo).

## Cable repair set 207 Series



Cable repair set ▶ for multicore cables ▶ Straight-through ▶ with glue ▶ Cable diameter 8 ... 24 mm ▶ with enclosed splicing connectors ▶ medium-walled ▶ black

Item No.	Pack. Unit
207-5485/316-000	18 (1)

### Set contains:

- 10 x Inline splicing connector 2773-2401
- 1 x Shrink tube 160 mm long
- 3 x Conductor H07 V-U 4 mm<sup>2</sup> black 150 mm long
- 1 x Conductor H07 V-U 4 mm<sup>2</sup> blue 150 mm long
- 1 x Conductor H07 V-U 4 mm<sup>2</sup> green/yellow 150 mm long



Drilled cable.



Milled cable.



Connect the cable using the cable repair kit.



Connect the cable using the cable repair kit.



Cable repair set ▶ for multicore cables ▶ Straight-through ▶ with glue ▶ Cable diameter 8 ... 24 mm ▶ with enclosed splicing connectors ▶ medium-walled ▶ black

Item No.	Pack. Unit
207-5465/316-000	18 (1)

### Set contains:

- 10 x Inline splicing connector 2773-2401
- 1 x Shrink tube 160 mm long



Close the damaged area discreetly.



Heat the shrink tube and properly reclose the damaged area.



### Splicing Connectors in Inaccessible Areas:

A change in the DIN VDE 0100-520:2013-06 standard makes it possible. Back in 2013, an exception was added to section 526.3 for connections that must not be accessible. This exception also includes splicing connectors per EN 60998 with maintenance-free spring pressure connection technology. With the matching shrink tube, they meet the requirements for double insulation, and the existing adhesive ensures grip and tightness.



# WAGO Splicing Connectors Sets

# WAGO Splicing Connectors Sets

		Page
	L-BOXX® 102	76
	L-BOXX® MINI	79
	L-BOXX® MICRO	84

## Splicing connector set ▶ L-BOXX® 102 887 Series



Splicing connector set; L-BOXX® 102; 221, 224, 243, 773, 2273 series

Dimensions WxHxD	Item No.	PU
445 x 118 x 358 mm	887-925	1

Splicing connector set; L-BOXX® 102; 221, 2273 series

Dimensions WxHxD	Item No.	PU
445 x 118 x 358 mm	887-926	1

Splicing connector set; L-BOXX® 102; 221series

Dimensions WxHxD	Item No.	PU
445 x 118 x 358 mm	887-927	1

### Content

Splicing connector with levers; 0,2 ... 4 mm<sup>2</sup>; transparent

Picture	Item No.	Number of conductors	Quantity
	221-412	2-conductor	100
	221-413	3-conductor	50
	221-415	5-conductor	25

### Content

Splicing connector with levers; 0,2 ... 4 mm<sup>2</sup>; transparent

Picture	Item No.	Number of conductors	Quantity
	221-412	2-conductor	100
	221-413	3-conductor	100
	221-415	5-conductor	25

### Content

Splicing connector with levers; 0,2 ... 4 mm<sup>2</sup>; transparent

Picture	Item No.	Number of conductors	Quantity
	221-412	2-conductor	100
	221-413	3-conductor	250
	221-415	5-conductor	50

2-conductor lighting connector; 1 ... 2,5 mm<sup>2</sup> „s“; white

	224-112	2-conductor	100
--	---------	-------------	-----

PUSH WIRE® splicing connector; 0,5 ... 2,5 mm<sup>2</sup>

	2273-202	2-conductor	100
	2273-203	3-conductor	100
	2273-204	4-conductor	100
	2273-205	5-conductor	100
	2273-208	8-conductor	50

Mounting carrier; for 2-, 3-, 5-conductor-Splicing connectors (4 mm<sup>2</sup>); orange

	221-500		10
--	---------	--	----

PUSH WIRE® splicing connector; Ø 0,6 ... 0,8 mm

	243-204	4-conductor	100
	243-208	8-conductor	50

PUSH WIRE® splicing connector; 0,5 ... 2,5 mm<sup>2</sup>

	2273-203	3-conductor	100
	2273-205	5-conductor	100
	2273-208	8-conductor	50

Mounting carrier; for 2-, 3-, 5-conductor-Splicing connectors (4 mm<sup>2</sup>); orange

	221-500		2
--	---------	--	---

Mounting carrier; for single- and double-row connectors; orange

	2273-500		2
--	----------	--	---

PUSH WIRE® splicing connector; 2,5 ... 6 mm<sup>2</sup> „s“; red

	773-173	3-conductor	100
--	---------	-------------	-----

Mounting carrier; for 2-, 3-, 5-conductor splicing connectors (4 mm<sup>2</sup>); orange

	221-500		4
--	---------	--	---

4

## Splicing connector set ▶ L-BOXX® 102 887 Series



Splicing connector set; L-BOXX® 102; Serie 221 – 4 mm² und 6 mm²

Dimensions WxHxD	Item No.	PU
445 x 118 x 358 mm	887-928	1

### Content

Splicing connector with levers; 0,2 ... 4 mm²; transparent

Picture	Item No.	Number of conductors	Quantity
	221-412	2-conductor	100
	221-413	3-conductor	250
	221-415	5-conductor	25

Splicing connector with levers; 0,5 ... 6 mm²; transparent

	221-615	5-conductor	30
--	---------	-------------	----

Mounting carrier; for 2-, 3-, 5-conductor splicing connectors (4 mm²); orange

	221-500	10
--	---------	----



Splicing connector set; L-BOXX® 102; 221 series – 4 mm² and 6 mm²

Dimensions WxHxD	Item No.	PU
445 x 118 x 358 mm	887-931	1

### Content

Splicing connector with levers; 0,2 ... 4 mm²; transparent

Picture	Item No.	Number of conductors	Quantity
	221-412	2-conductor	100
	221-413	3-conductor	250
	221-415	5-conductor	50

Splicing connector with levers; 0,5 ... 6 mm²; transparent

	221-612	2-conductor	50
	221-613	3-conductor	30
	221-615	5-conductor	5

Mounting carrier; for 2-, 3-, 5-conductor splicing connectors (4 mm²); orange

	221-500	2
--	---------	---

Mounting carrier; for single- and double-row connectors; orange

	221-510	2
--	---------	---



Splicing connector set; L-BOXX® 102; 221, 2273, 207 series

Dimensions WxHxD	Item No.	PU
445 x 118 x 358 mm	887-932	1

### Content

Splicing connector with levers; 0,2 ... 4 mm²; transparent

Picture	Item No.	Number of conductors	Quantity
	221-412	2-conductor	100
	221-413	3-conductor	50
	221-415	5-conductor	25

PUSH WIRE® splicing connector; 0,5 ... 2,5 mm²

	2273-202	2-conductor	100
	2273-203	3-conductor	100
	2273-205	5-conductor	100

Inline splicing connector with levers; 0,2 ... 4 mm²; transparent

	221-2411	2-conductor	60
--	----------	-------------	----

Mounting carrier; for 2-, 3-, 5-conductor splicing connectors (4 mm²)

	221-500	2
	221-500/000-006	1
	221-500/000-053	1

Jumper; 2-way

	221-941	5
	221-942/000-006	5

Gelbox; 221, 2x73 series; max. 4 mm²; gray

	207-1331	1
	207-1332	1
	207-1333	1

Mounting carrier; for single- and double-row connectors; orange

	2273-500	2
--	----------	---

Mounting carrier with strain relief; grau

	221-2503	2
--	----------	---

## Splicing connector set ► L-BOXX® 102 887 Series



### Splicing connector set; L-BOXX® 102; Serie 221

Dimensions WxHxD	Item No.	PU
445 x 118 x 358 mm	887-934	1

### Splicing connector set; L-BOXX® 102; Serie 221

Dimensions WxHxD	Item No.	PU
445 x 118 x 358 mm	887-1127	1

#### Content

Splicing connector with levers; 0,2 ... 4 mm<sup>2</sup>; transparent

Picture	Item No.	Number of conductors	Quantity
	221-412	2-conductor	100
	221-413	3-conductor	200
	221-415	5-conductor	50

#### Content

Splicing connector with levers; 0,2 ... 4 mm<sup>2</sup>; transparent

Picture	Item No.	Number of conductors	Quantity
	221-422	2-conductor	100
	221-423	3-conductor	250
	221-425	5-conductor	50

Mounting carrier; for 2-, 3-, 5-conductor splicing connectors (4 mm<sup>2</sup>); orange

	221-500	5
--	---------	---

Mounting carrier; for 2-, 3-, 5-conductor splicing connectors (4 mm<sup>2</sup>); orange

	221-500	10
--	---------	----

Inline splicing connector with levers; 0,2 ... 4 mm<sup>2</sup>; transparent

	221-2411	2-conductor	60
--	----------	-------------	----

Mounting carrier with strain relief; gray

	221-2502	100
	221-2503	100

## Splicing connector set ▶ L-BOXX® Mini 887 Series



### Splicing connector set; L-BOXX® Mini; 221 series

Dimensions WxHxD	Item No.	PU
259 x 63 x 155 mm	887-850	1

#### Content

Splicing connector with levers; 0,2 ... 4 mm<sup>2</sup>; transparent

Picture	Item No.	Number of conductors	Quantity
	221-412	2-conductor	100
	221-413	3-conductor	100
	221-415	5-conductor	25

Mounting carrier; for 2-, 3-, 5-conductor splicing connectors (4 mm<sup>2</sup>); orange

	221-500	2
--	---------	---

Inline splicing connector with levers; 0,2 ... 4 mm<sup>2</sup>; transparent

	221-2411	2-conductor	30
--	----------	-------------	----

Mounting carrier with strain relief; grau

	221-2502	1
	221-2503	1

### Splicing connector set; L-BOXX® Mini; 221 series

Dimensions WxHxD	Item No.	PU
259 x 63 x 155 mm	887-851	1

#### Content

Splicing connector with levers; 0,2 ... 4 mm<sup>2</sup>; transparent

Picture	Item No.	Number of conductors	Quantity
	221-412	2-conductor	100
	221-413	3-conductor	100
	221-415	5-conductor	25

Splicing connector with levers; 0,5 ... 6 mm<sup>2</sup>; transparent

	221-613	3-conductor	30
--	---------	-------------	----

Inline splicing connector with levers; 0,2 ... 4 mm<sup>2</sup>; transparent

	221-2411	2-conductor	30
--	----------	-------------	----

### Splicing connector set; L-BOXX® Mini; 221, 2273, 207 series

Dimensions WxHxD	Item No.	PU
259 x 63 x 155 mm	887-853	1

#### Content

Splicing connector with levers; 0,2 ... 4 mm<sup>2</sup>; transparent

Picture	Item No.	Number of conductors	Quantity
	221-413	3-conductor	50

Splicing connector with levers; 0,5 ... 6 mm<sup>2</sup>; transparent

	221-613	3-conductor	30
--	---------	-------------	----

Mounting carrier; for 2-, 3-, 5-conductor splicing connectors (4 mm<sup>2</sup>); orange

	221-500	1
--	---------	---

PUSH WIRE® splicing connector; 0,5 ... 2,5 mm<sup>2</sup>

	2273-203	3-conductor	50
	2273-205	5-conductor	20
	2273-208	8-conductor	12

Mounting carrier; for single- and double-row connectors; orange

	2273-500	1
--	----------	---

## Splicing connector set ▶ L-BOXX® Mini 887 Series



### Splicing connector set; L-BOXX® Mini; 221 series

Dimensions WxHxD	Item No.	PU
259 x 63 x 155 mm	887-952	1

### Splicing connector set; L-BOXX® Mini; 2273 series

Dimensions WxHxD	Item No.	PU
259 x 63 x 155 mm	887-953	1

### Splicing connector set; L-BOXX® Mini; 221, 2273 series

Dimensions WxHxD	Item No.	PU
259 x 63 x 155 mm	887-955	1

#### Content

Splicing connector with levers; 0,2 ... 4 mm<sup>2</sup>; transparent

Picture	Item No.	Number of conductors	Quantity
	221-412	2-conductor	100
	221-413	3-conductor	100
	221-415	5-conductor	25

Mounting carrier; for 2-, 3-, 5-conductor splicing connectors (4 mm<sup>2</sup>); orange

	221-500	4
--	---------	---

#### Content

PUSH WIRE® splicing connector; 0,5 ... 2,5 mm<sup>2</sup>

Picture	Item No.	Number of conductors	Quantity
	2273-202	2-conductor	100
	2273-203	3-conductor	100
	2273-204	4-conductor	100
	2273-205	5-conductor	75
	2273-208	8-conductor	25

Mounting carrier; for single- and double-row connectors; orange

	2273-500	4
--	----------	---

#### Content

Splicing connector with levers; 0,2 ... 4 mm<sup>2</sup>; transparent

Picture	Item No.	Number of conductors	Quantity
	221-412	2-conductor	75
	221-413	3-conductor	50
	221-415	5-conductor	25

PUSH WIRE® splicing connector; 0,5 ... 2,5 mm<sup>2</sup>

	2273-203	3-conductor	100
	2273-205	5-conductor	75
	2273-208	8-conductor	25

Mounting carrier; for 2-, 3-, 5-conductor splicing connectors (4 mm<sup>2</sup>); orange

	221-500	1
--	---------	---

Mounting carrier; for single- and double-row connectors; orange

	2273-500	1
--	----------	---

## Splicing connector set ▶ L-BOXX® Mini 887 Series



Splicing connector set; L-BOXX® Mini; 221 series – 4 mm<sup>2</sup> and 6 mm<sup>2</sup>

Dimensions WxHxD	Item No.	PU
259 x 63 x 155 mm	887-957	1

### Content

Splicing connector with levers; 0,2 ... 4 mm<sup>2</sup>; transparent

Picture	Item No.	Number of conductors	Quantity
	221-412	2-conductor	75
	221-413	3-conductor	50
	221-415	5-conductor	25

Splicing connector with levers; 0,5 ... 6 mm<sup>2</sup>; transparent

	221-612	2-conductor	40
	221-613	3-conductor	30
	221-615	5-conductor	15

Mounting carrier; for 2-, 3-, 5-conductor splicing connectors (4 mm<sup>2</sup>); orange

	221-500	1
--	---------	---

Splicing connector set; L-BOXX® Mini; 221 series – 4 mm<sup>2</sup> and 6 mm<sup>2</sup>

Dimensions WxHxD	Item No.	PU
259 x 63 x 155 mm	887-959	1

### Content

Splicing connector with levers; 0,2 ... 4 mm<sup>2</sup>; transparent

Picture	Item No.	Number of conductors	Quantity
	221-412	2-conductor	100
	221-413	3-conductor	100
	221-415	5-conductor	25

Splicing connector with levers; 0,5 ... 6 mm<sup>2</sup>; transparent

	221-613	3-conductor	30
--	---------	-------------	----

Splicing connector set; L-BOXX® Mini; 221, 224, 2273 series

Dimensions WxHxD	Item No.	PU
259 x 63 x 155 mm	887-960	1

### Content

Splicing connector with levers; 0,2 ... 4 mm<sup>2</sup>; transparent

Picture	Item No.	Number of conductors	Quantity
	221-412	2-conductor	20
	221-413	3-conductor	15
	221-415	5-conductor	10

Splicing connector with levers; 0,5 ... 6 mm<sup>2</sup>; transparent

	221-613	3-conductor	5
--	---------	-------------	---

2-conductor lighting connector; 1 ... 2,5 mm<sup>2</sup> „s“; white

	224-112	2-conductor	15
--	---------	-------------	----

PUSH WIRE® splicing connector; 0,5 ... 2,5 mm<sup>2</sup>

	2273-202	2-conductor	40
	2273-203	3-conductor	30
	2273-204	4-conductor	25
	2273-205	5-conductor	20
	2273-208	8-conductor	15

## Splicing connector set ► L-BOXX® MINI 887 Series



Splicing connector set; L-BOXX® Mini; 221 series; Green Range

Dimensions WxHxD	Item No.	PU
259 x 63 x 155 mm	887-1150	1

Splicing connector set; L-BOXX® Mini; 221 series; Green Range

Dimensions WxHxD	Item No.	PU
259 x 63 x 155 mm	887-1152	1

Splicing connector set; L-BOXX® Mini; 221 series; Green Range

Dimensions WxHxD	Item No.	PU
259 x 63 x 155 mm	887-1159	1

### Content

Splicing connector with levers; 0,2 ... 4 mm<sup>2</sup>; transparent

Picture	Item No.	Number of conductors	Quantity
	221-422	2-conductor	100
	221-423	3-conductor	100
	221-425	5-conductor	25

### Content

Splicing connector with levers; 0,2 ... 4 mm<sup>2</sup>; transparent

Picture	Item No.	Number of conductors	Quantity
	221-422	2-conductor	100
	221-423	3-conductor	100
	221-425	5-conductor	50

### Content

Splicing connector with levers; 0,2 ... 4 mm<sup>2</sup>; transparent

Picture	Item No.	Number of conductors	Quantity
	221-422	2-conductor	100
	221-423	3-conductor	100
	221-425	5-conductor	25

Mounting carrier; for 2-, 3-, 5-conductor splicing connectors (4 mm<sup>2</sup>); orange

	221-500	2
--	---------	---

Inline splicing connector with levers; 0,2 ... 4 mm<sup>2</sup>; transparent

	221-2431	2-conductor	30
--	----------	-------------	----

Mounting carrier with strain relief; gray

	221-2502	1
	221-2503	1

Splicing connector with levers; 0,5 ... 6 mm<sup>2</sup>; transparent

	221-623	3-conductor	30
--	---------	-------------	----



## Splicing connector set ► L-BOXX® MICRO 887 Series



### Splicing connector set; L-BOXX® MICRO; 221, 2273 series

Dimensions WxHxD	Item No.	PU
259 x 42 x 106 mm	887-802	1

#### Content

Splicing connector with levers; 0,2 ... 4 mm<sup>2</sup>; transparent

Picture	Item No.	Number of conductors	Quantity
	221-412	2-conductor	10
	221-413	3-conductor	20
	221-415	5-conductor	8

### PUSH WIRE® splicing connector; 0,5 ... 2,5 mm<sup>2</sup>

	2273-203	3-conductor	50
	2273-205	5-conductor	20
	2273-208	8-conductor	12

### Mounting carrier; for 2-, 3-, 5-conductor splicing connectors (4 mm<sup>2</sup>); orange

	221-500		1
--	---------	--	---

### Mounting carrier; for single- and double-row connectors; orange

	2273-500		1
--	----------	--	---

### Splicing connector set; L-BOXX® MICRO; 221 series

Dimensions WxHxD	Item No.	PU
259 x 42 x 106 mm	887-803	1

#### Content

Splicing connector with levers; 0,2 ... 4 mm<sup>2</sup>; transparent

Picture	Item No.	Number of conductors	Quantity
	221-412	2-conductor	20
	221-413	3-conductor	35
	221-415	5-conductor	8

### Inline splicing connector with levers; 0,2 ... 4 mm<sup>2</sup>; transparent

	221-2411	2-conductor	30
--	----------	-------------	----

### Splicing connector set; L-BOXX® MICRO; 221 series

Dimensions WxHxD	Item No.	PU
259 x 42 x 106 mm	887-804	1

#### Content

Splicing connector with levers; 0,2 ... 4 mm<sup>2</sup>; transparent

Picture	Item No.	Number of conductors	Quantity
	221-412	2-conductor	15
	221-413	3-conductor	20
	221-415	5-conductor	8

### Mounting carrier; for 2-, 3-, 5-conductor splicing connectors (4 mm<sup>2</sup>); orange

	221-500		1
--	---------	--	---

### Splicing connector with levers; 0,5 ... 6 mm<sup>2</sup>; transparent

	221-612	2-conductor	5
	221-613	3-conductor	5

### Inline splicing connector with levers; 0,2 ... 4 mm<sup>2</sup>; transparent

	221-2411	2-conductor	15
--	----------	-------------	----

### Mounting carrier with strain relief; gray

	221-2503		1
--	----------	--	---

## Splicing connector set ► L-BOXX® MICRO 887 Series



Splicing connector set; L-BOXX® MICRO; 221, 2273, 207 series

Dimensions WxHxD	Item No.	PU
259 x 42 x 106 mm	887-805	1

### Content

Splicing connector with levers; 0,2 ... 4 mm<sup>2</sup>; transparent

Picture	Item No.	Number of conductors	Quantity
	221-412	2-conductor	15
	221-413	3-conductor	20
	221-415	5-conductor	8

Mounting carrier; for 2-, 3-, 5-conductor splicing connectors (4 mm<sup>2</sup>); orange

	221-500	1
--	---------	---

PUSH WIRE® splicing connector; 0,5 ... 2,5 mm<sup>2</sup>

	2273-202	2-conductor	15
	2273-203	3-conductor	20
	2273-208	8-conductor	12









Gelbox; 221, 2x73 series; max. 4 mm<sup>2</sup>; gray

	207-1331	15
	207-1332	20



## **WAGO Accessories and WAGO Tools**

## WAGO Accessories and WAGO Tools

		Page
	<b>Mounting adapter ▶ for splicing connectors with levers</b> 221 Series 222 Series	89 99
	<b>Jumper ▶ for splicing connectors with levers</b> 221 Series	91
	<b>Mounting adapter ▶ for single splicing connectors with levers</b> 221 Series	93
	<b>Mounting adapter ▶ for inline splicing connectors with levers</b> 221 Series	97
	<b>Mounting adapter ▶ for PUSH WIRE® splicing connectors</b> 243 Series 773 Series 2273 Series	105 102 100
	<b>Screw driver ▶ VDE tested</b> 206 Series	106
	<b>Cable strippers</b> 206 Series	108
	<b>Wire strippers</b> 206 Series	110
	<b>"Alu-Plus" Contact Paste</b> 249 Series	112

# Mounting Carrier ▶ for Splicing Connectors with Levers ▶ for DIN-35 Rail or Screw Mount 221 Series Installation



Inserting a connector into the mounting carrier.

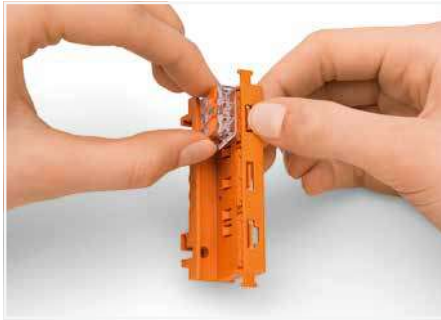

Removing a connector from the mounting carrier.



Removing a conductor.



Testing connectors via test slots on top of the carrier.

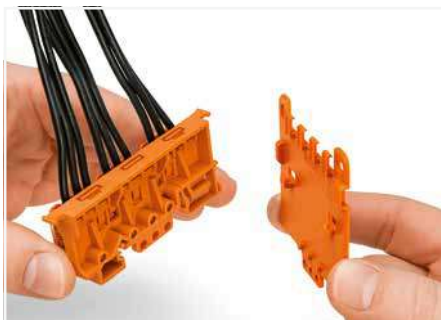

Securing a strain relief plate (222-505) to the mounting carrier.



Snapping the angled DIN-rail adapter (222-510) onto the mounting carrier.



Strain relief via cable ties on the mounting carrier (transverse to the connectors' wiring direction) – clamping units labeled via marking strips (210-334)



Vertical mounting with strain relief plate on DIN-35 rail



Horizontal mounting on DIN-35 rail using an angled DIN-rail adapter



Horizontal screw mounting with strain relief plate on a flat surface



Vertical screw mounting with strain relief plate on a flat surface

5

# Mounting Carrier ▶ for Splicing Connectors with Levers ▶ for DIN-35 Rail or Screw Mount 221 Series

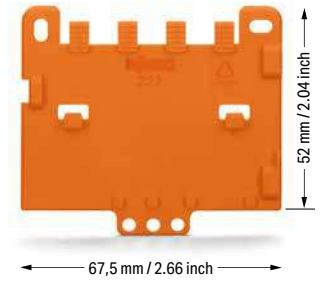
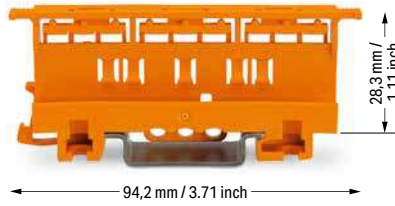

Mounting carrier; for 2-, 3- and 5-wire splicing connectors (4 mm<sup>2</sup>); 17.5 mm wide

Color	Item No.	PU (SPU)
● orange	221-500	50 (10)
● blue	221-500/000-006 ☞	50 (10)
● darkgray-yellow	221-500/000-053	50 (10)
○ light gray	221-501 ☞	50 (10)

Mounting carrier; for 2-, 3- and 5-wire splicing connectors (6 mm<sup>2</sup>); 19.3 mm wide

Color	Item No.	PU (SPU)
● orange	221-510	50 (10)
● blue	221-510/000-006 ☞	50 (10)
● darkgray-yellow	221-510/000-053	50 (10)
○ light gray	221-511 ☞	50 (10)

Strain relief plate; for mounting carrier (221 or 222 Series); snaps on to mounting carrier; 4 mm thick

Color	Item No.	PU (SPU)
● orange	222-505	50 (10)

**Accessories; item-specific**

Marking strip; 5 mm high; 48 self-adhesive strips per card; plain

Color	Item No.	PU (SPU)
white	210-334	100

**Accessories; item-specific**

Marking strip; 5 mm high; 48 self-adhesive strips per card; plain

Color	Item No.	PU (SPU)
white	210-334	100

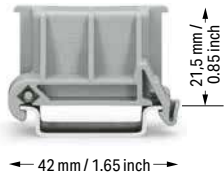

Angled DIN-rail adapter; in combination with mounting carrier (221-500 or 222-500) for DIN-35 rail mounting; 18.5 mm wide

Color	Item No.	PU (SPU)
○ gray	222-510	50 (10)

# Jumpers With and Without Locking Function

## 221 Series

### Installation

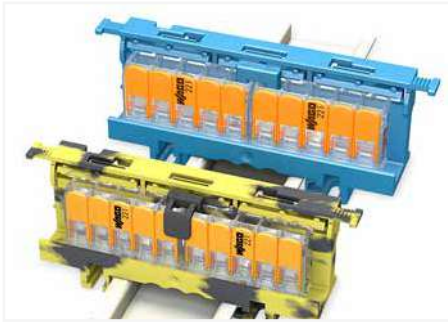

Extending the N and PE (ground) distribution via jumper

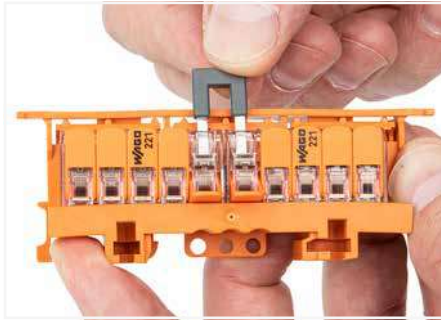

Insert the jumper without a locking function into open clamping units.

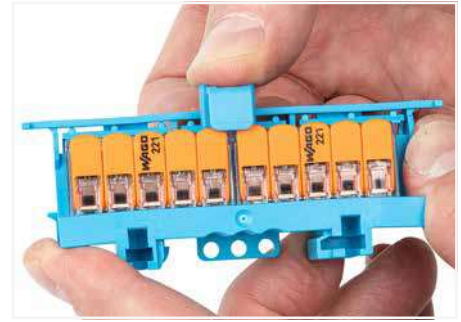

Insert the jumper with a locking function into closed clamping units.



Without locking function:  
The jumper without a locking function is plugged into the splicing connectors.

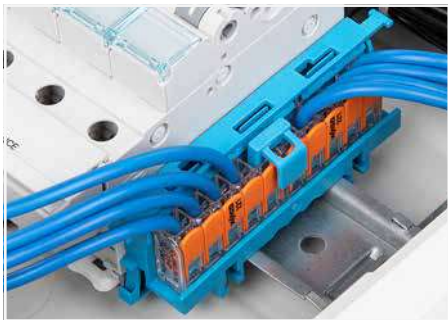

With locking function:  
The jumper with a locking function is plugged into the splicing connectors.

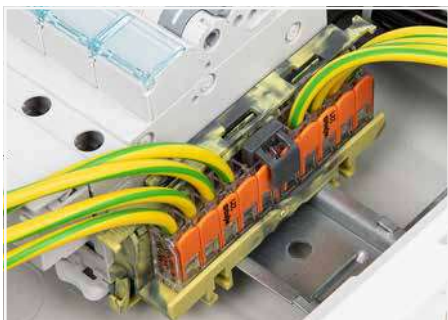

The lockable jumper is plugged into the splicing connectors.

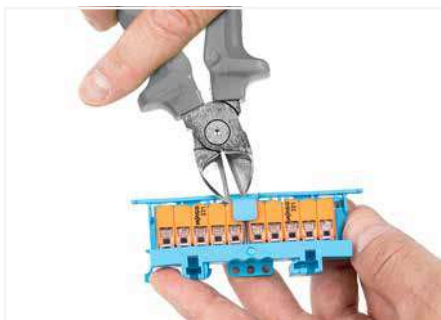

Remove the locking mechanism for intentional jumper removal.



Remove the jumper from open clamping units.

5

## Jumper With and Without Locking Function 221 Series



Jumper; with locking function		
Color	Item No.	PU
● dark gray	221-941	50
● blue	221-941/000-006	50

Jumper; without locking function		
Color	Item No.	PU
● dark gray	221-942	50
● blue	221-942/000-006	50

# Mounting Carrier ▶ for Single Connectors 221 Series Installation



Inserting a connector into the mounting carrier.



Removing a connector from the mounting carrier.



Inserting a conductor.



Use a cable tie to secure the conductors to the strain relief plate.



Labeling the mounting carrier.



Testing a connector mounted on the carrier via test slot.



The strain relief plate can be removed.



Horizontal screw mounting



Vertical screw mounting



Horizontal mounting via snap-in foot



Vertical mounting via snap-in foot



Connecting a light to the mains.

5

# Mounting Carrier ▶ for Single Connectors ▶ 4 mm<sup>2</sup> 221 Series



for 2-wire connectors; for screw mounting  
Dimensions from the surface (mm) W x H x D  
18.1 x 16.9 x 52.8

Color	Item No.	PU (SPU)
○ white	221-502	50 (10)
● black	221-502/000-004	50 (10)

for 3-wire connectors; for screw mounting  
Dimensions from the surface (mm) W x H x D  
18.1 x 16.9 x 52.8

Color	Item No.	PU (SPU)
○ white	221-503	50 (10)
● black	221-503/000-004	50 (10)

for 5-wire connectors; for screw mounting  
Dimensions from the surface (mm) W x H x D  
18.1 x 16.9 x 52.8

Color	Item No.	PU (SPU)
○ white	221-505	50 (10)
● black	221-505/000-004	50 (10)

for 2-wire connectors; with snap-in mounting foot for horizontal mounting  
Dimensions from the surface (mm) W x H x D  
18.1 x 16.9 (+ 4.5 snap-in mounting foot) x 52.8

Color	Item No.	PU (SPU)
○ white	221-512	50 (10)
● black	221-512/000-004	50 (10)

for 3-wire connectors; with snap-in mounting foot for horizontal mounting  
Dimensions from the surface (mm) W x H x D  
18.1 x 16.9 (+ 4.5 snap-in mounting foot) x 52.8

Color	Item No.	PU (SPU)
○ white	221-513	50 (10)
● black	221-513/000-004	50 (10)

for 5-wire connectors; with snap-in mounting foot for horizontal mounting  
Dimensions from the surface (mm) W x H x D  
18.1 x 16.9 (+ 4.5 snap-in mounting foot) x 52.8

Color	Item No.	PU (SPU)
○ white	221-515	50 (10)
● black	221-515/000-004	50 (10)

for 2-wire connectors; with snap-in mounting foot for vertical mounting  
Dimensions from the surface (mm) W x H x D  
18.1 x 52.8 (+ 4.5 snap-in mounting foot) x 16.9

Color	Item No.	PU (SPU)
○ white	221-522	50 (10)
● black	221-522/000-004	50 (10)

for 3-wire connectors; with snap-in mounting foot for vertical mounting  
Dimensions from the surface (mm) W x H x D  
18.1 x 52.8 (+ 4.5 snap-in mounting foot) x 16.9

Color	Item No.	PU (SPU)
○ white	221-523	50 (10)
● black	221-523/000-004	50 (10)

for 5-wire connectors; with snap-in mounting foot for vertical mounting  
Dimensions from the surface (mm) W x H x D  
18.1 x 52.8 (+ 4.5 snap-in mounting foot) x 16.9

Color	Item No.	PU (SPU)
○ white	221-525	50 (10)
● black	221-525/000-004	50 (10)

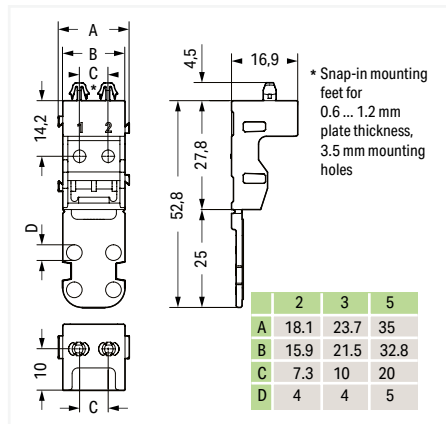
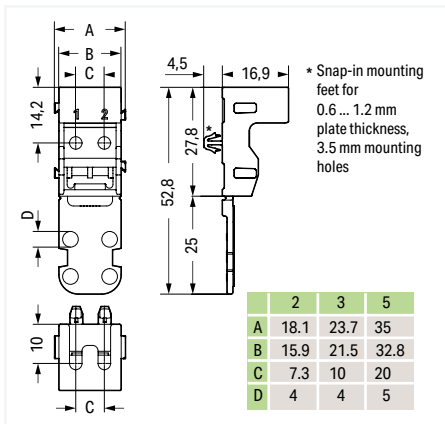
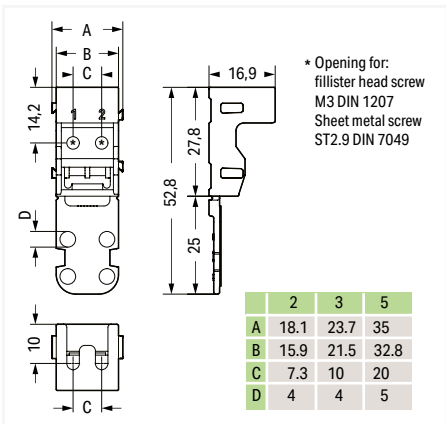

### Accessories; for all products on this page

Marking strip; 5 mm high; 48 self-adhesive strips per card; plain

	white	210-334	100
---	-------	---------	-----

PU = Packaging Unit; SPU = Subpackaging Unit; Dimensions in mm

# Mounting Carrier ▶ for 10-Wire Single Connectors ▶ 4 mm<sup>2</sup> 221 Series



for screw mounting; with strain relief  
Dimensions from the surface (mm) W x H x D  
38.3 x 23.7 x 59.5

Color	Item No.	PU (SPU)
○ white	221-509	50 (10)
● black	221-509/000-004	50 (10)
● red	221-509/000-005	50 (10)
● blue	221-509/000-006	50 (10)
● dark gray/yellow	221-509/000-053	50 (10)

for side screw mounting; with strain relief  
Dimensions from the surface (mm) W x H x D  
39.5 x 23.7 x 55

Color	Item No.	PU (SPU)
○ white	221-519	50 (10)
● blue	221-519/000-006	50 (10)
● dark gray/yellow	221-519/000-053	50 (10)

with snap-in mounting foot; with strain relief  
Dimensions from the surface (mm) W x H x D  
18.1 x 52.8 (+ 4.5 snap-in mounting foot) x 16.9

Color	Item No.	PU (SPU)
○ white	221-529	50 (10)
● blue	221-529/000-006	50 (10)
● dark gray/yellow	221-529/000-053	50 (10)

for screw mounting; without strain relief  
Dimensions from the surface (mm) W x H x D  
18.1 x 16.9 x 52.8

○ white	221-509/002-000	50 (10)
● black	221-509/002-004	50 (10)
● red	221-509/002-005	50 (10)
● blue	221-509/002-006	50 (10)
● dark gray/yellow	221-509/002-053	50 (10)

for side screw mounting; without strain relief  
Dimensions from the surface (mm) W x H x D  
18.1 x 16.9 x 52.8

○ white	221-519/002-000	50 (10)
● blue	221-519/002-006	50 (10)
● dark gray/yellow	221-519/002-053	50 (10)

with snap-in mounting foot; without strain relief  
Dimensions from the surface (mm) W x H x D  
18.1 x 52.8 (+ 4.5 snap-in mounting foot) x 16.9

○ white	221-529/002-000	50 (10)
● blue	221-529/002-006	50 (10)
● dark gray/yellow	221-529/002-053	50 (10)

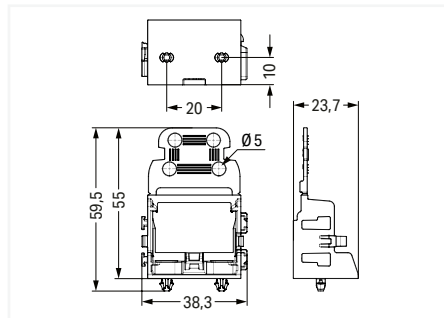
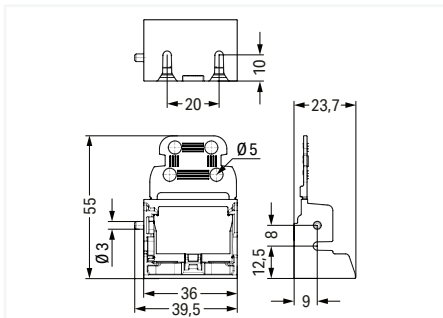
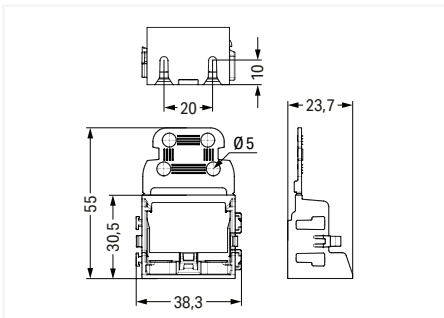

## Accessories; for all products on this page

Marking strip; strip width 5 mm; 48 strips per card; strip length 182 mm; plain; self-adhesive

white	210-334	100
-------	---------	-----

PU = Packaging Unit; SPU = Subpackaging Unit; Dimensions in mm

# Mounting Carrier ▶ for 10-Wire Single Connectors ▶ 4 mm<sup>2</sup> 221 Series



for DIN-15 rail; with strain relief  
Dimensions from the surface (mm) W x H x D  
18.1 x 16.9 x 52.8

Color	Item No.	PU (SPU)
○ white	221-539	50 (10)
● black	221-539/000-004	50 (10)
● red	221-539/000-005	50 (10)
● blue	221-539/000-006	50 (10)
● dark gray/yellow	221-539/000-053	50 (10)
○ light gray	221-539/1000-000	50 (10)

for DIN-35 rail; with strain relief  
Dimensions from the surface (mm) W x H x D  
18.1 x 16.9 x 52.8

Color	Item No.	PU (SPU)
○ white	221-549	50 (10)
● black	221-549/000-004	50 (10)
● red	221-549/000-005	50 (10)
● blue	221-549/000-006	50 (10)
● dark gray/yellow	221-549/000-053	50 (10)
○ light gray	221-549/1000-000	50 (10)

for DIN-15 rail; without strain relief  
Dimensions from the surface (mm) W x H x D  
18.1 x 16.9 x 52.8

○ white	221-539/002-000	50 (10)
● black	221-539/002-004	50 (10)
● red	221-539/002-005	50 (10)
● blue	221-539/002-006	50 (10)
● dark gray/yellow	221-539/002-053	50 (10)
○ light gray	221-539/1002-000	50 (10)

for DIN-35 rail; without strain relief  
Dimensions from the surface (mm) W x H x D  
18.1 x 16.9 x 52.8

○ white	221-549/002-000	50 (10)
● black	221-549/002-004	50 (10)
● red	221-549/002-005	50 (10)
● blue	221-549/002-006	50 (10)
● dark gray/yellow	221-549/002-053	50 (10)
○ light gray	221-549/1002-000	50 (10)

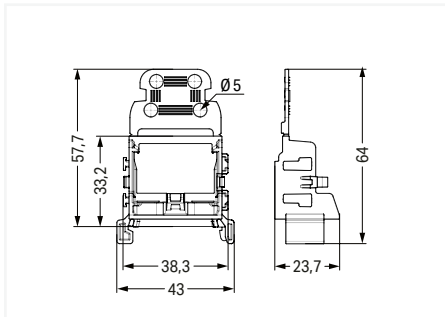
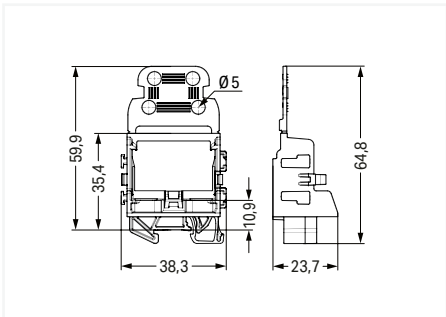

**Accessories; for all products on this page**

Marking strip; strip width 5 mm; 48 strips per card; strip length 182 mm; plain; self-adhesive

	white	210-334	100
---	-------	---------	-----

PU = Packaging Unit; SPU = Subpackaging Unit; Dimensions in mm

# Mounting Carrier ▶ for Inline Splicing Connectors ▶ for DIN-35 Rail or Screw Mount 221 Series Installation



Place the inline splicing connector on the carrier in front of the mounting position.



Push the connector to the center position until it snaps into place.



Conductor wiring can also be performed in fixed position.



Various combinations of 1- to 5-connector mounting carriers are possible via side-by-side latching mechanism.

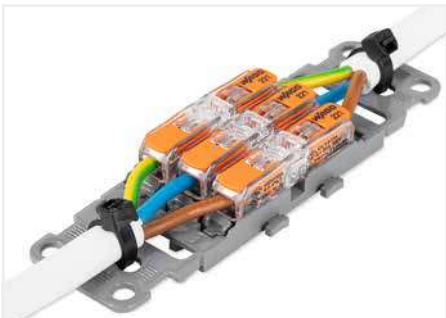

3-pole mounting carrier with strain relief



Mounting carrier without strain relief – snapped onto DIN-rail

5

# Mounting Carrier ▶ for Inline Splicing Connectors ▶ for DIN-35 Rail or Screw Mount 221 Series



for screw mounting; with strain relief; gray

Design	Item No.	PU (SPU)
○ 1x	221-2501	25 (5)
○ 2x	221-2502	25 (5)
○ 3x	221-2503	25 (5)
○ 4x	221-2504	25 (5)
○ 5x	221-2505	25 (5)

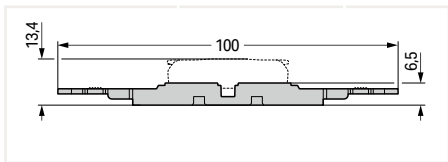

for screw mounting; gray

Design	Item No.	PU (SPU)
○ 1x	221-2521	25 (5)
○ 2x	221-2522	25 (5)
○ 3x	221-2523	25 (5)
○ 4x	221-2524	25 (5)
○ 5x	221-2525	25 (5)

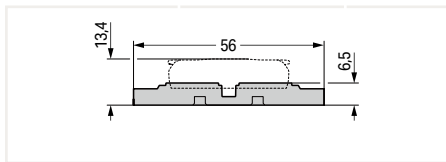

with snap-in mounting foot; with strain relief; gray

Design	Item No.	PU (SPU)
○ 1x	221-2511	25 (5)
○ 2x	221-2512	25 (5)
○ 3x	221-2513	25 (5)
○ 4x	221-2514	25 (5)
○ 5x	221-2515	25 (5)

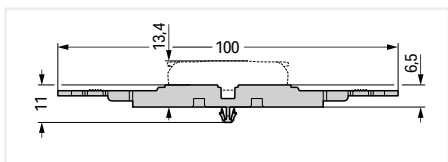

with snap-in mounting foot; gray

Design	Item No.	PU (SPU)
○ 1x	221-2531	25 (5)
○ 2x	221-2532	25 (5)
○ 3x	221-2533	25 (5)
○ 4x	221-2534	25 (5)
○ 5x	221-2535	25 (5)

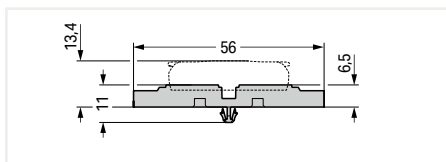

## Accessories; for all products on this page

Mounting foot; snaps onto terminal blocks with snap-in mounting foot; for DIN-35 rail; 6.4 mm wide

gray	209-120	25
------	---------	----



Mounting foot with screw; can be screwed on terminal blocks with mounting flange; for DIN-35 rail; 6.4 mm wide

gray	209-123	25
------	---------	----



Mounting foot; can be screwed on terminal blocks with mounting flange; for DIN-15 rail; 6.4 mm wide

gray	209-1116	25
------	----------	----



Mounting screw; for mounting foot (209-120)

	209-119	500 (50)
--	---------	----------



Mounting foot; snaps onto terminal blocks with snap-in mounting foot; for DIN-15 rail; 6.4 mm wide

gray	209-1115	25
------	----------	----



Marking strips; on reel; 5 mm wide; plain; self-adhesive; white

white	210-834	100
-------	---------	-----



PU = Packaging Unit; SPU = Subpackaging Unit; Dimensions in mm

# Mounting Carrier ▶ for Splicing Connectors with Levers ▶ for DIN-35 Rail or Screw Mount 222 Series Installation



Horizontal mounting on DIN-35 rail using an angled DIN-rail adapter



Horizontal mounting with strain relief plate on DIN-35 rail using an angled DIN-rail adapter

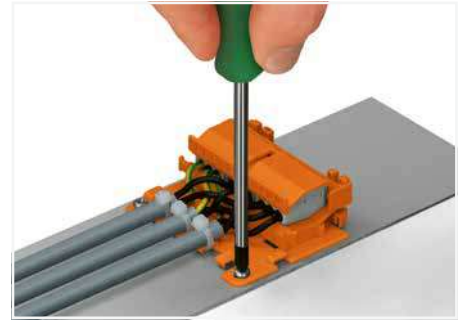

Horizontal screw mounting with strain relief plate on a flat surface



Vertical mounting with strain relief plate on DIN-35 rail; Marking clamping units via marking strips.



Strain relief via cable ties on the mounting carrier (transverse to the connectors' wiring direction); Molded marking clamping units

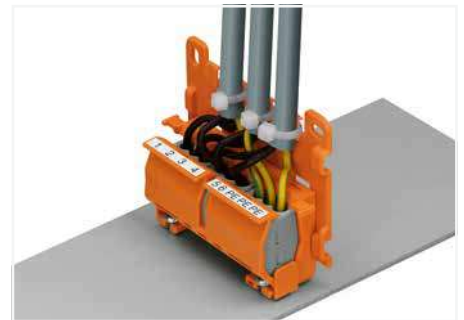

Mounting carrier with strain relief plate mounted vertically on a plate; Round cable secured via strain relief lug.



Snapping the lateral connector safety lock onto the mounting carrier.



Securing a strain relief plate to the mounting carrier.

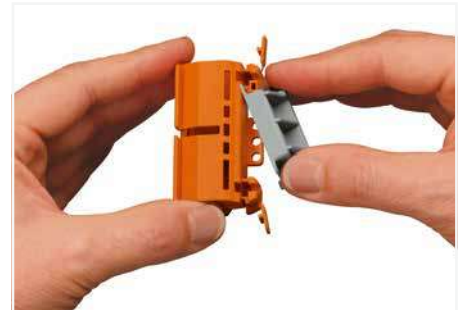

Snapping the angled DIN-rail adapter onto the mounting carrier.

5

# Mounting Carrier ▶ for Splicing Connectors with Levers ▶ for DIN-35 Rail or Screw Mount 222 Series



Mounting carrier; for 2-, 3- and 5-wire splicing connectors; 22 mm wide

Color	Item No.	PU (SPU)
orange	222-500	50 (10)

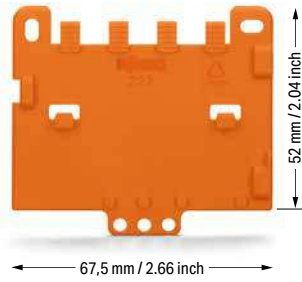

Strain relief plate; for mounting carrier (221 or 222 Series); snaps on to mounting carrier; 4 mm thick

Color	Item No.	PU (SPU)
orange	222-505	50 (10)

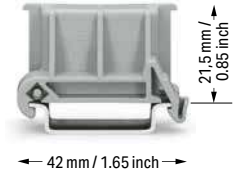

Angled DIN-rail adapter; in combination with mounting carrier (221-500 or 222-500) for DIN-35 rail mounting; 18.5 mm wide

Color	Item No.	PU (SPU)
gray	222-510	50 (10)

### Accessories; item-specific

Marking strip; 5 mm high; 48 self-adhesive strips per card; plain

	white	210-334	100
---	-------	---------	-----

## Mounting Carrier ▶ for PUSH WIRE® Splicing Connectors ▶ for DIN-35 Rail or Screw Mount 2273 Series



Mounting carrier; for single- and double-row connectors

Color	Item No.	PU (SPU)
orange	2273-500	50 (10)

Accessories; item-specific

Marking strips; on reel; 5 mm wide; plain; self-adhesive; white

white	210-334	100
-------	---------	-----

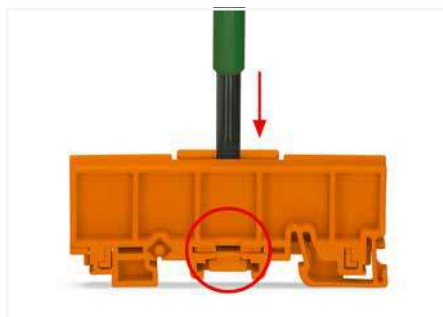

To adjust the mounting carrier, unlock the latch via operating tool (5.5 mm blade) and move the clamping slide to the required width by rotating the tool.

The mounting carrier is suitable for both connector widths.

One single carrier can hold up to 24 clamping units in a very narrow space. Previously, this was only possible using rail-mount terminal blocks.

Advantages:

- Mount carrier onto DIN-35 rail or via screws – easily and quickly
- Accommodate three 2.5 mm<sup>2</sup> (12 AWG) 2273 Series Connectors in a single carrier
- Easily exchange connectors
- Large marking area for self-adhesive marking strips or for direct marking with permanent felt-tip pen

**PUSH WIRE® Connectors in Distribution Boxes**

During distribution box retrofits or expansions, conductors often require extensions or additional clamping points. Individual PUSH WIRE® connectors (e.g., 2773 Series) are approved as interconnect components for building wiring applications per EN 60998. Application standards for building installation (e.g., Parts 510 and 520 from DIN VDE 0100) also place the following requirements on junction box connectors:

- They must be arranged so that operation, inspection, maintenance and access to the removable connectors is simplified.
- It must be possible to test them.
- Conductors connected from outside must be clearly and permanently assigned to their associated circuits.

These requirements cannot be met with PUSH WIRE® connectors alone. In combination with mounting carriers, the PUSH WIRE® connectors clearly meet these requirements, making them comparable to rail-mount terminal blocks. Using PUSH WIRE® connectors with mounting carriers in distribution boxes is accepted by testing authorities.



# Mounting Carrier ▶ for PUSH WIRE® Junction Box Connectors ▶ for DIN-35 Rail or Screw Mount 773 Series

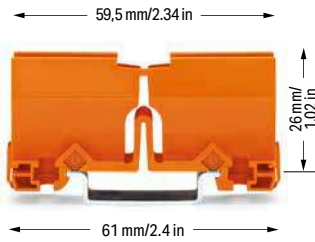

Mounting carrier; for all 773 Series PUSH WIRE® Connectors for Junction Boxes

Color	Item No.	PU (SPU)
orange	773-332	50 (10)

Accessories; item-specific

Marking strips; on reel; 5 mm wide; plain; self-adhesive; white

white	210-834	1
-------	---------	---



Use the cover as an end plate.



Snap the mounting carrier onto the DIN-rail.

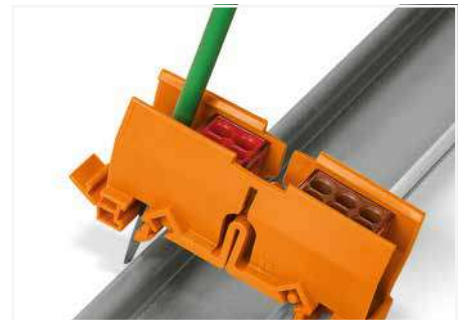

Remove the mounting carrier from the DIN-rail.



A mounting carrier (see accessories) suits applications where the connectors must be marked and secured in position. The DIN-35 rail-mount carrier fits up to six connectors and can also be mounted on a flat surface using two screws.

Using this PUSH WIRE® connector, a large range of wiring applications can be achieved in distribution or junction boxes. To mention just a few: potential multiplication and changing from or to 6 mm<sup>2</sup> (10 AWG) conductor size.

# Mounting Carrier ▶ for Ex PUSH WIRE® Junction Box Connectors ▶ for DIN-35 Rail or Screw Mount 773 Series

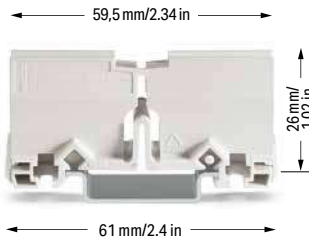

Wiring example in an Ex junction box

Mounting carrier; for Ex PUSH WIRE® junction box connectors

Color	Item No.	PU (SPU)
○ light gray ☺	773-331	50 (10)

#### Accessories; item-specific

Marking strips; on reel; 5 mm wide; plain; self-adhesive; white

white	210-834	1
-------	---------	---



Insert the connectors into the carrier.

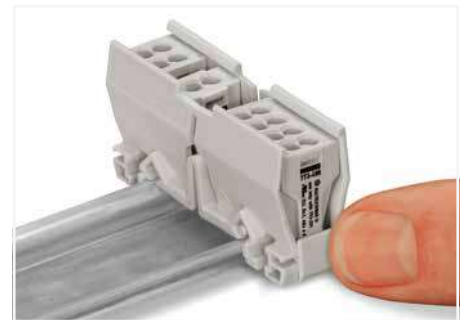

Use the cover as an end plate.



Snap the mounting carrier onto the DIN-rail.



Remove the mounting carrier from the DIN-rail.

Ex PUSH WIRE® connectors are ideal for distribution and junction boxes, as well as control and operating systems. When used in hazardous areas, they offer the following advantages over traditional connectors:

- Time- and cost-saving PUSH WIRE® connection
- Vibration-proof, maintenance-free connections
- 100% touch-proof protection
- Connectors can be secured in position via mounting carriers
- One single carrier equipped with 2-, 4-, 6- and 8-wire connectors holds up to 16 clamping units according to user requirements, saving materials and related costs
- Available as OEM products for manufacturers and suppliers of enclosures and distribution boxes used in hazardous areas

## Mounting Carrier ▶ for PUSH WIRE® Splicing connectors ▶ for DIN-35 Rail or Screw Mount

### 243 Series

#### Description and Installation

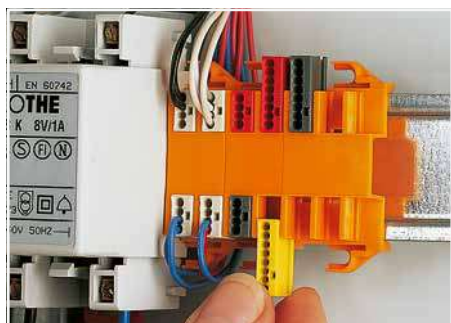

Inserting a MICRO junction box connector into the mounting carrier.

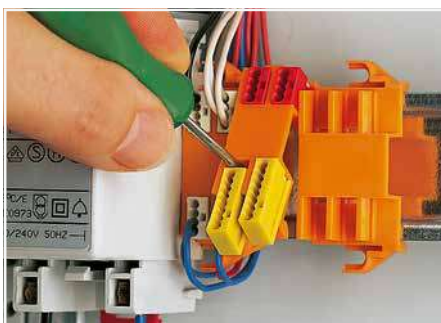

Removing a mounting carrier from the assembly.



Example of a residential door bell application – carriers mounted on a DIN-35 rail

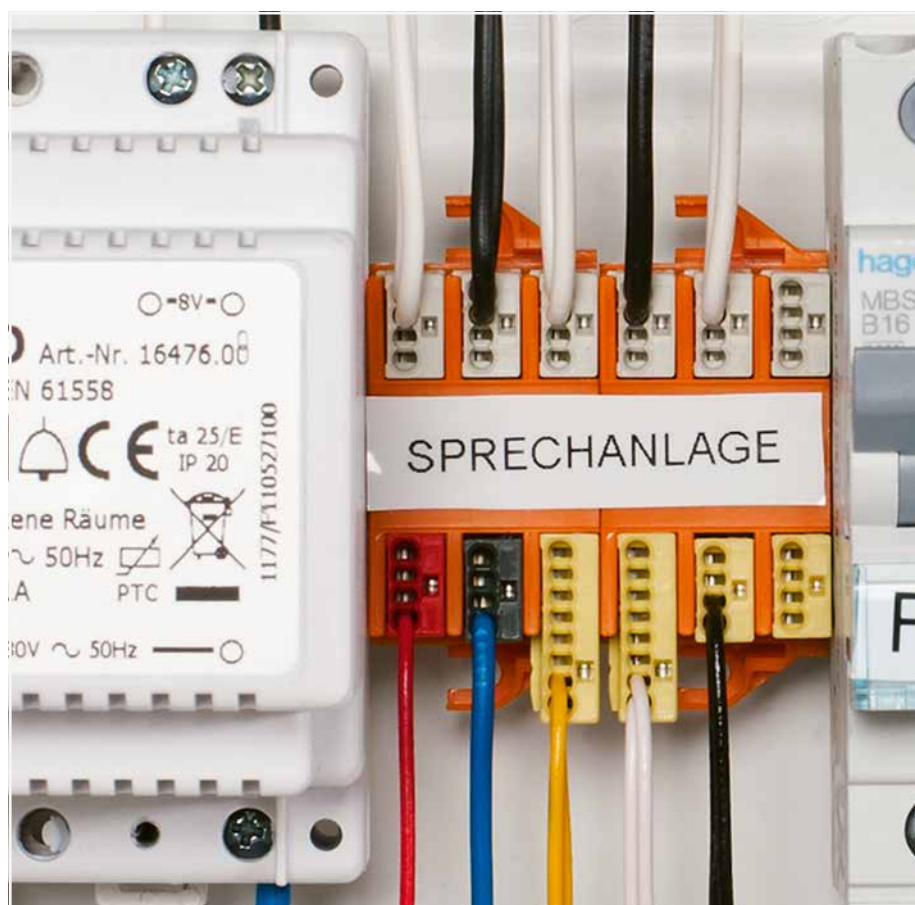

Example of a residential intercom application

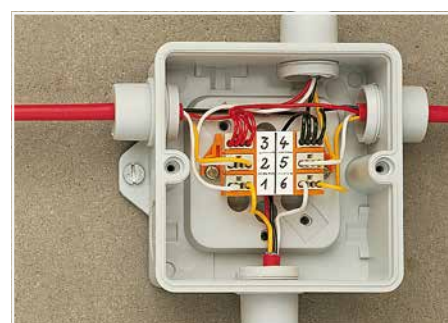

Typical application in a terminal box for burglar alarm – screw-mounted carrier

#### Quick Fix Mounting

Realizing MICRO PUSH WIRE® connectors for junction boxes are ideal for DIN-rail-mount panel applications, electrical installers have requested the ability to use them in distribution panels. These connectors provide easy connections for smaller conductors used in low-current applications. They are well-suited to terminating telephone-style conductors for connecting alarms, bells, door sensors, communication systems, etc.

The mounting carrier is WAGO's professional solution. It is available with mounting slots for 4 or 6 connectors.

Depending on the number of conductors, each mounting slot can accommodate a 4- or 8-conductor MICRO PUSH WIRE® junction box connector. The connectors simply snap into the mounting slots and are removable, allowing conductors to be exchanged during changeover.

The carrier is designed for easy mounting directly to the DIN-35 rail, or to a panel, via the screw-mount flanges provided on both sides. A large marking area for direct marking with a permanent felt-tip pen or for pre-printed self-adhesive marking strips is provided for clear circuit identification.

## Mounting Carrier ▶ for PUSH WIRE® Splicing connectors ▶ for DIN-35 Rail or Screw Mount 243 Series

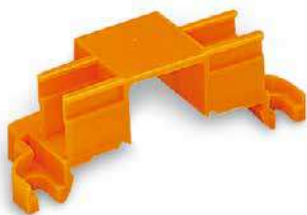

❶ When using conductors of the same diameter, 0.5 mm (24 AWG) or 1 mm (18 AWG) diameters are also possible.

❷ 100 V = rated voltage  
1.5 kV = rated impulse voltage  
2 = pollution degree  
(see Section 14)

Approvals and corresponding ratings, visit [www.wago.com](http://www.wago.com)

### Quick Fix Mounting

Realizing MICRO PUSH WIRE® connectors for junction boxes are ideal for DIN-rail-mount panel applications, electrical installers have requested the ability to use them in distribution panels. These connectors provide easy connections for smaller conductors used in low-current applications. They are well-suited for terminating telephone-style conductors for connecting alarms, bells, door sensors, communication systems, etc.

The mounting carrier is WAGO's professional solution. It is available with mounting slots for 4 or 6 connectors.

Depending on the number of conductors, each mounting slot can accommodate a 4- or 8-conductor MICRO PUSH WIRE® junction box connector. The connectors simply snap into the mounting slots and are removable, allowing conductors to be exchanged during changeover.

The carrier is designed for easy mounting directly to the DIN-35 rail, or to a panel, via the screw-mount flanges provided on both sides. A large marking area for direct marking with a permanent felt-tip pen or for pre-printed self-adhesive marking strips is provided for clear circuit identification.

#### for 4 connectors

Color	Item No.	PU (SPU)
orange	243-112	50 (10)

#### for 6 connectors

orange	243-113	50 (10)
--------	---------	---------

#### Accessories; item-specific

Marking strip; 7 mm high; 6 self-adhesive strips per card; plain

	white	243-110	100
---	-------	---------	-----

The 243 Series can be used in both communication and alarm systems according to the VdS (German Association of Property Insurers) guidelines.

No general approval is given to PUSH WIRE® connectors by the VdS association. The connectors must be tested together with the different parts of the system.

The requirements for connectors are specified in the VdS guidelines for junction boxes (VdS 2116) in section 9.8: "The junction box connectors must be designed to guarantee a reliable and stable connection."

The verification of the fulfillment of these requirements is documented in the VDE test report No. 2574-1440-4031 for the insulated 243 Series PUSH WIRE® Connectors.

## Screwdriver ▶ VDE tested ▶ 1000 V ▶ insulated 206 Series



Slot screwdriver ▶ (2,5 x 0,4) mm ▶ 75 mm long		
Color	Item No.	PU
green/gray	206-2111	1

Crosshead screwdriver ▶ PH0 ▶ 60 mm long		
Color	Item No.	PU
green/gray	206-2120	1

Crosshead screwdriver ▶ PZ0 ▶ 60 mm long		
Color	Item No.	PU
green/gray	206-2130	1

Slot screwdriver ▶ (3,0 x 0,5) mm ▶ 100 mm long		
Color	Item No.	PU
green/gray	206-2112	1

Crosshead screwdriver ▶ PH1 ▶ 80 mm long		
Color	Item No.	PU
green/gray	206-2121	1

Crosshead screwdriver ▶ PZ1 ▶ 80 mm long		
Color	Item No.	PU
green/gray	206-2131	1

Slot screwdriver ▶ (3,5 x 0,6) mm ▶ 100 mm long		
Color	Item No.	PU
green/gray	206-2113	1

Crosshead screwdriver ▶ PH2 ▶ 100 mm long		
Color	Item No.	PU
green/gray	206-2122	1

Crosshead screwdriver ▶ PZ2 ▶ 100 mm long		
Color	Item No.	PU
green/gray	206-2132	1

Slot screwdriver ▶ (4,0 x 0,8) mm ▶ 100 mm long		
Color	Item No.	PU
green/gray	206-2114	1

Crosshead screwdriver ▶ PH3 ▶ 150 mm long		
Color	Item No.	PU
green/gray	206-2123	1

Crosshead screwdriver ▶ PZ3 ▶ 150 mm long		
Color	Item No.	PU
green/gray	206-2133	1

Slot screwdriver ▶ (5,5 x 1,0) mm ▶ 125 mm long		
Color	Item No.	PU
green/gray	206-2115	1

Slot screwdriver ▶ (6,5 x 1,2) mm ▶ 150 mm long		
Color	Item No.	PU
green/gray	206-2116	1

Slot screwdriver ▶ (8,0 x 1,2) mm ▶ 175 mm long		
Color	Item No.	PU
green/gray	206-2117	1

# Screwdriver ▶ VDE tested ▶ 1000 V ▶ insulated 206 Series



Torx® screwdriver ▶ T8 ▶ 180 mm long		
Color	Item No.	PU
green/gray	206-2163	1

Torx® screwdriver ▶ T10 ▶ 180 mm long		
Color	Item No.	PU
green/gray	206-2164	1

Torx® screwdriver ▶ T15 ▶ 190 mm long		
Color	Item No.	PU
green/gray	206-2165	1

Torx® screwdriver ▶ T20 ▶ 190 mm long		
Color	Item No.	PU
green/gray	206-2166	1

Torx® screwdriver ▶ T25 ▶ 190 mm long		
Color	Item No.	PU
green/gray	206-2167	1

Torx® screwdriver ▶ T30 ▶ 215 mm long		
Color	Item No.	PU
green/gray	206-2169	1



Combination screwdriver ▶ Cross and slot ▶ +/- PH1/S ▶ 190 mm long		
Color	Item No.	PU
green/gray	206-2141	1

Combination screwdriver ▶ Cross and slot ▶ +/- PH2/S ▶ 215 mm long		
Color	Item No.	PU
green/gray	206-2142	1



Combination screwdriver ▶ Cross and slot ▶ +/- PZ1/S ▶ 190 mm long		
Color	Item No.	PU
green/gray	206-2151	1

Combination screwdriver ▶ Cross and slot ▶ +/- PZ2/S ▶ 215 mm long		
Color	Item No.	PU
green/gray	206-2152	1



Screwdriver set ▶ PH1; PH2; PZ1; 2,5 x 0,4; 3,5 x 0,6; 5,5 x 0,8		
Color	Item No.	PU
green/gray	206-2101	1



Torx® screwdriver set ▶ T8; T10; T15; T20; T25; T30		
Color	Item No.	PU
green/gray	206-2102	1

PU = Packaging Unit; SPU = Subpackaging Unit

# Cable Knife 206 Series



Never use this tool on or near live electrical circuits!

Cable knife ▶ for Ø 8 ... 28 mm / 0.31 ... 1.10 inch ▶ with a unique, changeable cable bracket system ▶ including cable bracket

Color	Item No.	PU
green/black	206-1403	1

Cable knife set ▶ for Ø 4 ... 70 mm / 0.16 ... 2.75 inch ▶ including all cable brackets in a Sortimo® Box

Item No.	PU
206-1400	1



To replace the cable bracket, use the new bracket as an operating tool and pull it upwards.

### Item-Specific Accessories

Cable bracket; for Ø 4 ... 16 mm / 0.16 ... 0.63 inch

	206-1411	1
--	----------	---

Cable bracket; for Ø 8 ... 28 mm / 0.31 ... 1.10 inch

	206-1412	1
--	----------	---

Cable bracket; for Ø 27 ... 35 mm / 1.06 ... 1.38 inch

	206-1413	1
--	----------	---

Cable bracket; for Ø 35 ... 50 mm / 1.38 ... 1.97 inch

	206-1414	1
--	----------	---

Cable bracket; for Ø 50 ... 70 mm / 1.97 ... 2.75 inch

	206-1415	1
--	----------	---

### Accessories

Spare inside blade

	206-1418	1
--	----------	---

Spare hook blade

	206-1419	1
---	----------	---



The cutting depth of the hook blade can be adjusted with the slider.



The cutting depth of the inner knife can be adjusted with the screw.

5

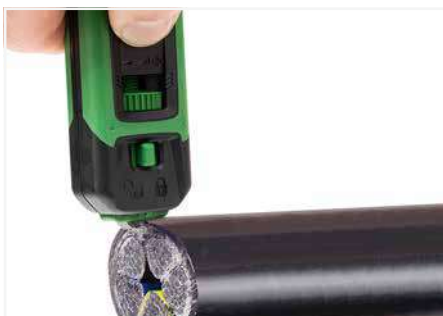

Strip large cross sections with the hook blade.



Release the fuse before using the hook blade.

PU = packaging unit; SPU = subpackaging unit

## Cable Stripper 206 Series



In-socket cable stripper ▶  
for Ø 8 ... 13 mm / 5/16 ... 1/2 inch

Color	Item No.	PU
green/black	206-1441	1

Universal cable stripper ▶  
for Ø 8 ... 13 mm / 5/16 ... 1/2 inch

Color	Item No.	PU
green/black	206-1442	1

Data cable stripper ▶  
for Ø 4.5 ... 10 mm / 3/16 ... 3/8 inch

Color	Item No.	PU
green/black	206-1451	1



Product features:

- Extra long design and improved force transmission simplifies stripping in deep device connection sockets
- Special four-blade design for an even more precise round cut
- No cutting depth adjustment required
- TiN-coated blades, TÜV/GS tested
- Ø 8 ... 13 mm / 5/16 ... 1/2 inch
- Strips all standard round cables, including NYM 3 x 1.5 mm<sup>2</sup>/16 AWG ... 5 x 2.5 mm<sup>2</sup>/14 AWG



Sheath stripping: longitudinal cut

Product features:

- Secure grip achieved with soft padding for non-slip grips
- Technically improved functionality
- New locking mechanism prevents the unwanted opening of the tool
- Absolutely straightforward, quick and easy longitudinal cuts – with innovative internal cable duct
- Redesigned blade layout and intake to stop cable waste from jamming the tool
- Durable and ergonomically designed pocket clip
- Ø 8 ... 13 mm / 5/16 ... 1/2 inch



Product features:

- Strip outer insulation and foil sheathing with one tool
- Ideal for stripping PVC-insulated data cables with thin insulation (e.g., Cat. 5, Cat. 6, Cat. 7, twisted pair cable)
- TiN-coated blades
- Ø 4.5 ... 10 mm / 3/16 ... 3/8 inch



Built-in handy knife



Stripping a conductor insulation.



## Wire Stripper 206 Series



Wire stripper "Quickstrip Vario" ▶  
0.03 ... 16 mm<sup>2</sup> / 34 ... 6 AWG ▶ with wire cutter

Color	Item No.	PU
green/black	206-1125	1

### Accessories

Blade set; Standard; 0.03 ... 16 mm<sup>2</sup> / 34 ... 6 AWG

	206-1126	1
---	----------	---

Blade set; V-blade; 0.14 ... 4 mm<sup>2</sup> / 24 ... 12 AWG

	206-1127	1
---	----------	---

Blade set; Oval blade; 10 ... 16 mm<sup>2</sup> / 8 ... 6 AWG

	206-1128	1
--	----------	---

Spare stripping stop

	206-1129	1
---	----------	---

Spare cut protector

	206-1131	1
---	----------	---

Spare clamping jaws

	206-1132	1
---	----------	---



Cutting a conductor.

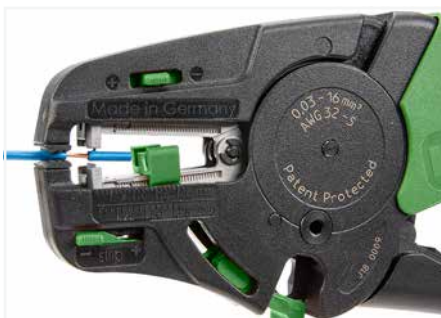

Partially stripping a conductor.

### Wire Stripper:

- Automatically adjust to conductor size
- Stripping blades cause no damage to conductor strands
- Gripping pressure of jaws adjusts automatically to conductor insulation diameter
- Clamping jaws and stripping blades automatically open once the stripping process is completed – no splaying of the conductor strands
- Exact strip length may be set by sliding black setting stop
- Stripping blades can be replaced
- Self-sharpening, fully protected cutter (replaceable)
- Entire body made of glass-fiber-reinforced polyamide
- Cutting capacity of the wire cutter of fine-stranded conductors up to 16 mm<sup>2</sup> (6 AWG)

## Wire Stripper 206 Series



Wire stripper ▶ for PVC insulation ▶ 0,2 ... 6 mm<sup>2</sup>;  
with wire cutter; 2-component grip

Color	Item No.	PU
green/black	206-1141	1



Adjustable length stop: 6 ... 15 mm. Insert stranded wire or conductor. The pliers automatically adjust to the conductor cross-section. Squeeze pliers – open – done!



Three wire cutters up to 2.5 mm<sup>2</sup>: Insert conductor to be cut and done!

### Automatic Wire Stripper

Automatically adjusts to the conductor cross-section; no damage to the conductor possible. Suitable for all conductor types with cross sections of 0,2 mm<sup>2</sup> up to 6,0 mm<sup>2</sup> (stripping tool). With integrated wire cutter for conductors with max. cross section of 2.5 mm<sup>2</sup> (cutting tool). **Warning: Never use this tool on or near live electrical circuits!**

## "Alu-Plus" Contact Paste ▶ Terminating Aluminum Conductors 249 Series



Syringe; contains 20 ml "Alu-Plus" Contact Paste

Item No.	PU (SPU)
249-130	20 (5)



### WAGO Lighting Connectors

Push nozzle of the "Alu-Plus" syringe first into the circular entry and then into the square conductor entry hole of the WAGO Lighting Connector.



Press plunger down until the "Alu-Plus" has filled both entry holes.

**Note:** Not suitable for higher temperature applications!

### Terminating Aluminum Conductors

WAGO spring clamp terminal blocks are suitable for solid aluminum conductors ① up to 4 mm<sup>2</sup>/12 AWG if WAGO "Alu-Plus" Contact Paste is used for termination.

#### "Alu-Plus" Contact Paste Advantages:

- Automatically destroys the oxide film during clamping.
- Prevents fresh oxidation at the clamping point.
- Prevents electrolytic corrosion between aluminum and copper conductors (in the same terminal block).
- Provides long-term protection against corrosion.



### WAGO Rail-Mount Terminal Blocks (up to 4 mm<sup>2</sup>/12 AWG)

For each conductor entry: Insert nozzle of the "Alu-Plus" syringe in every open conductor entry hole (one after the other).



Press plunger down until "Alu-Plus" has filled all conductor entry holes.

For spring clamp connections with PUSH WIRE® connection technology, WAGO recommends that the aluminum conductor first be cleaned and then immediately inserted into the clamping unit filled with "Alu-Plus" contact paste

WAGO "Alu-Plus" in the syringe offers a higher degree of reliability and cleanliness when terminating solid aluminum conductors. Filling is quickly performed on selected WAGO connectors and terminal blocks (see pictures).

① Aluminum conductors per IEC 61545 standard, Class B, "Alloy 1370" with 90 ... 180 N/mm<sup>2</sup> tensile strength and 1 ... 4% elongation  
Standard values: 90 ... 180 MPa tensile strength, 1 ... 4% elongation (per EN 615.4.1)

Using terminal blocks with CAGE CLAMP® Spring Pressure Connection Technology, aluminum conductors must first be cleaned with a blade and then immediately be inserted into the clamping units filled with "Alu-Plus" Contact Paste.

It is also possible to apply WAGO "Alu-Plus" additionally on the whole surface of the aluminum conductor before termination.

Please note that the nominal currents must be adapted to the reduced conductivity of the aluminum conductors:

$$2.5 \text{ mm}^2 \text{ (14 AWG)} = 16 \text{ A}$$









$$4 \text{ mm}^2 \text{ (12 AWG)} = 22 \text{ A}$$

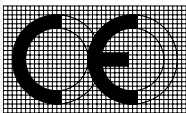

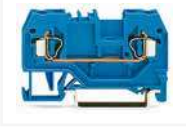

# Technical Section

## Technical Section

	Page
	116
	118
<b>Tests and testing procedures</b> Mechanical, Electrical, Material and Environmental Tests	120
<b>UL Specifications – Underwriters Laboratories, USA</b> Tests and Testing Procedures per UL Standards	140
	145
<b>Material Specifications</b> Insulation Materials, Contact Plating, Contact Materials and Clamping Spring Material	146
	149
<b>Technical Information on Electrical Equipment</b> Used in Hazardous Areas Ⓢ	149
	
All terminal blocks used in hazardous areas "Ex e II" have their item numbers marked with the Ex symbol.	
	
All terminal blocks used in intrinsically safe current circuits "Ex i" have their item numbers marked with a blue circle.	
	160
<b>Electrical Engineering Laboratory</b> Product Safety for Our Customers	160
	162
<b>WAGO Seminars</b> Learn Today – Benefit Tomorrow Benefit from First-Hand Knowledge and Expertise – Training Straight from the Source!	162
	164
<b>Environmental protection at WAGO</b>	164

## Operating WAGO Connection Technologies

Please follow the applicable product-specific termination instructions.

### PUSH-IN CAGE CLAMP®



Push-in CAGE CLAMP® terminates the following copper conductors: solid



stranded



fine-stranded, also with tinned single strands



fine-stranded, tip-bonded



fine-stranded, with ferrule (gastight crimped)



fine-stranded, with pin terminal (gastight crimped)

The universal connection with an additional advantage:

Push-in connection

Terminate solid and stranded (Class B 7 strands or less), as well as ferruled conductors, by simply pushing them in – no tools required.

Termination for all conductor types:

- Open clamping unit.
- Insert the conductor.
- Release clamp – done!

### CAGE CLAMP®



CAGE CLAMP® terminates the following copper conductors: solid



stranded



fine-stranded, also with tinned single strands



fine-stranded, tip-bonded



fine-stranded, with ferrule (gastight crimped)



fine-stranded, with pin terminal (gastight crimped)

6

The universal connection for solid, stranded and fine-stranded conductors

Termination:

- Open clamping unit.
- Insert the conductor.
- Release clamp – done!

## Operating WAGO Connection Technologies

Please follow the applicable product-specific termination instructions.

### POWER CAGE CLAMP®



POWER CAGE CLAMP terminates the following copper conductors:  
solid



stranded



fine-stranded,  
also with tinned  
single strands



fine-stranded,  
with ferrule  
(gastight crimped)

The universal connection for conductors larger than 35 mm<sup>2</sup> (2 AWG)

Termination:

- Open clamp by turning a T-wrench counter-clockwise.
- Press the integrated latch to open clamping unit for hands-free wiring.
- Insert the conductor.
- A small counter-clockwise rotation closes the clamp, securing conductor.

### PUSH WIRE®

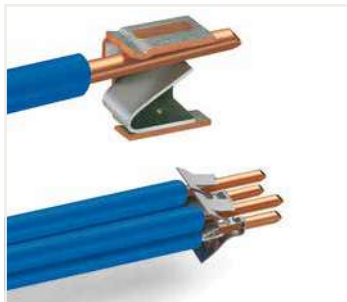

PUSH WIRE® terminates the following copper conductors:  
solid

PUSH WIRE® connection for solid and stranded conductors (depending on the model used)

Termination:

Tool-free, twist-free terminations for solid and rigid stranded conductors – simply push into the unit.

## CE Marking and EC Directives

### CE Conformity Marking

The CE conformity marking consists of the characters "CE" with the following script:

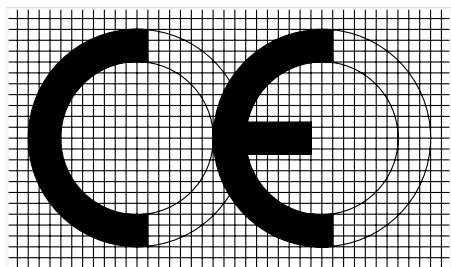

Communauté Européenne  
(European Community)

WAGO GmbH & Co. KG products are developed, tested and marked in accordance with legally valid international standards and laws.

The CE mark is applied to products intended for the European domestic market; with it, manufacturers declare that the marked electrical equipment conforms with the applicable requirements set out in the Community harmonization legislation (EU Directives), which allows such equipment to carry this mark.

The original intention of this mark was to support the authorities in the EU member states in their market supervision, with the mark acting as a symbol of free movement of products within the EU. According to EC Directive 765/2008, a product can only be given the CE mark if the product requirements are defined in at least one appropriate EU directive. Examples of such directives are the Low Voltage Directive, the EMC Directive, the ATEX Directive, the Building Products Directive and the Machinery Directive. If more than one directive applies to a product, the product must comply with all applicable directives.

Only the basic requirements for achieving the defined aim of the directive are laid out in each respective directive. The individual technical details are specified according to the New Approach using lists with cross references to applicable standards (so-called harmonized standards).

#### 1. Low Voltage Directive (LVD)

The safety of electrical equipment is guaranteed by the Low Voltage Directive (LVD). The LVD covers all electrical equipment operating with a voltage between 50 VAC and 1000 VAC and between 75 VDC and 1500 VDC.

Products falling within the scope of the Low Voltage Directive that are designed in such a way that they can be used in other electrical devices, and whose safety, for the most part, is dependant on how these components were built into the end product and what features the end product has, are defined as basic components in accordance with the Low Voltage Directive.

The LVD doesn't apply to basic components.

The RoHS Directive also applies to electrical equipment covered by the Low Voltage Directive. This directive regulates the use of hazardous substances

in electrical devices and components, with the aim of reducing the quantity of problematic components in electrical waste. Details about the materials used by WAGO are available in our catalogs, on our product packaging and on our Web page.

#### 2. EMC Directive

The EMC Directive stipulates that a product must meet the limits on radiated electromagnetic disturbance and also requires that a product must be immune to electromagnetic interference.

Electromagnetic passive components or components with no direct function, such as terminal blocks, resistors, diodes, capacitors, switching relays or cables (in the form of passive printed circuit boards) are not considered as apparatus within the meaning of the EMC Directive.

#### 3. ATEX Directive on Explosion Protection

The ATEX Directive defines the rules for products (devices and protective systems) intended for use in hazardous locations. A number of products from WAGO are designed for use in hazardous areas.

Based on potential hazards, the ATEX Directive makes a distinction between three different equipment groups, of which Group II and III are subdivided into further zones. Suitability of WAGO products for the different groups and zones is outlined in the specific product documents (catalogs, Internet site, data sheets and product inserts).

These may be either devices that can be used as equipment in these types of areas, or components that are required for safe operation, but which do not fulfill a dedicated function. Such components include rail-mount terminal blocks for use in hazardous areas.

Products in both groups must comply with the ATEX Directive.

#### 4. Radio Communications Directive

The Radio Communications Directive applies to all devices that properly transmit or receive radio waves for wireless communications and/or radio orientation. The basic safety requirements apply to the protection of health for humans and animals and to electrical safety in line with the Low Voltage Directive, but without the application of the voltage limit. In addition, the EMC protection goals of the EMC Directive must also be fulfilled and efficient use of radio frequencies ensured. WAGO products covered by the Radio Communications Directive indicate, in compliance with applicable laws, only the Radio Communication Directive in their EU Declaration of Conformity, as fulfillment of the Low Voltage Directive and of the EMC Directive is implicit in this declaration.

#### 5. Construction Products Regulation

The Construction Products Regulation demands that structures be designed and constructed such that the safety of humans, property and animals is not endangered and that all applicable environmental protection requirements be considered. Here, building products are defined as products or construction sets which are produced to be built permanently into structures and which make a significant contribution to fulfilling the basic requirements for the structure.

nificant contribution to fulfilling the basic requirements for the structure.

In the unanimous opinion expressed by the German electrical industry, including WAGO GmbH & Co. KG, products used in general installation technology are not included among these types of building products and are therefore not covered by this directive.

#### 6. Machinery Directive

The Machinery Directive applies to machines (complete or incomplete) which perform their functions by means other than direct human or animal work, or safety components for these types of machines.

Therefore, this directive usually does not apply to WAGO products.

The manufacturers of machines or systems are required by this directive to use safe products and components in their machines and systems. Directive-compliant production and safe operation is facilitated by the use of WAGO products, with their standard-compliant, up-to-date design.

#### Significance of CE Mark for WAGO Products

One, several or none of the EU Directives may apply to the various WAGO products. If none of the directives apply, the CE marking will not be affixed to the product, in line with applicable laws. Furthermore, a declaration of conformity must not be issued. All other products are provided with the CE mark – either directly on the product, on its packaging or in the documents included with the product – and a declaration of conformity is issued, or made accessible to the customer.

The data sheets of the technically sound products that, according to the regulations, are not CE marked will refer to the standards used in the development and type and manufacturing testing wherever possible.

## IEC/EN specifications

The following standards apply to the design and application of the terminal blocks and connectors contained in this catalog:

IEC 60364-1 HD 60364-1 VDE 0100-100 / Erection of power installations with nominal voltages up to 1000 V – Part 1: Fundamental principles, assessment of general characteristics, definitions	EN 50628 VDE 0118-10 / Installation of electrical equipment in mines	IEC 60999-2 EN 60999-2 VDE 0609-101 /– Part 2: General requirements and particular requirements for clamping units for conductors from 35 mm <sup>2</sup> up to 300 mm <sup>2</sup> (included)
IEC 60364-7-710 HD 60364-7-710 VDE 0100-710 /– Part 7-718: Requirements for special installations or locations – Medical areas	IEC 60038 EN 60038 VDE 0175-1 / IEC CENELEC standard voltages	IEC 60998-1 EN 60998-1 VDE 0613-1 / Connecting devices for low-voltage circuits for household and similar purposes – Part 1: General requirements
IEC 60364-7-718 HC 60364-7-718 VDE 0100-718 /– Part 7-718: Requirements for special installations or locations – Communal facilities and workplaces	VDE 0298-4 / Use of cables and insulated conductors in power installations – Part 4: Recommended values for current carrying capacities of cables for fixed installation and for flexible cables	IEC 60998-2-1 EN 60998-2-1 VDE 0613-2-1 /– Part 2-1: Particular requirements for connecting devices as separate entities with screw-type clamping units
EN 50110-1 VDE 0105-1 / Operation of electrical installations – Part 1: General requirements	IEC 60112 EN 60112 VDE 0303-11 / Method for determining the comparative and the proof tracking indices of solid insulation materials	IEC 60998-2-2 EN 60998-2-2 VDE 0613-2-2 /– Part 2-2: Particular requirements for connecting devices as separate entities with screwless-type clamping units
IEC 60664-1 EN 60664-1 VDE 0110-1 / Insulation coordination for equipment within low-voltage systems – Part 1: Principles, requirements and tests	IEC 60529 EN 60529 VDE 0470-1 / Degrees of protection provided by enclosures (IP Code) – Testing equipment and testing method	IEC 60998-2-3 EN 60998-2-3 VDE 0613-2-3 /– Part 2-3: Particular requirements for connecting devices as separate entities with insulation-piercing clamping units
IEC 60204-1 EN 60204-1 VDE 0113-1 / Safety of machinery – Electrical equipment of machines – Part 1: General requirements	IEC 61439-1 EN 61439-1 VDE 0660-600-1 / Low-voltage switchgear and control-gear assemblies – Part 1: General rules	IEC 60947-1 EN 60947-1 VDE 0660-100 / Low-voltage switchgear and controlgear – Part 1: General rules
IEC 61140 EN 61140 VDE 0140-1 / Protection against electric shock – Common aspects for installation and equipment	IEC 61439-3 EN 61439-3 VDE 0660-600-3 /– Low-voltage switchgear and control-gear assemblies – Part 3: Distribution boards intended to be operated by ordinary persons (DBO)	IEC 60947-7-1 EN 60947-7-1 VDE 0611-1 /– Part 7-1: Ancillary equipment – Terminal blocks for copper conductors
IEC 60079-0 EN 60079-0 VDE 0170-1 / Hazardous areas – Part 0: Equipment – General requirements	IEC 61643-11 EN 61643-11 VDE 0675-6-11 / Low-voltage surge protective devices – Part 11: Surge protective devices connected to low-voltage power systems – Requirements and test methods	IEC 60947-7-2 EN 60947-7-2 VDE 0611-3 /– Part 7-2: Ancillary equipment – Ground conductor terminal blocks for copper conductors
IEC 60079-7 EN 60079-7 VDE 0170-6 / Explosive atmospheres – Part 7: Equipment protection by increased safety “e”	IEC 60335-1 EN 60335-1 VDE 0700-1 / Safety of household and similar electrical appliances – Part 1: General requirements	IEC 60947-7-3 EN 60947-7-3 VDE 0611-6 /– Part 7-3: Ancillary equipment – Safety requirements for fuse terminal blocks
IEC 60079-11 EN 60079-11 VDE 0170-7 / Hazardous areas – Part 11: Equipment protection by intrinsic safety “i”	IEC 60598-1 EN 60598-1 VDE 0711-1 / Lighting fixtures – Part 1: General requirements and tests	VDE 0611-4 / Rail-mount terminal blocks for connection of copper conductors; – Multi-level distribution rail-mount terminal blocks up to 6 mm <sup>2</sup>
IEC 60079-14 EN 60079-14 VDE 0165-1 / Hazardous areas – Part 14: Electrical installations design, selection and erection	IEC 60715 EN 60715 /– Standardized mounting on rails for mechanical support of electrical devices in switchgear and control-gear installations	IEC 61984 EN 61984 VDE 0627 / Connectors – Safety requirements and tests
IEC 60079-15 EN 60079-15 VDE 0170-16 / Explosive atmospheres – Part 15: Equipment protection by type of protection “n”	IEC 60999-1 EN 60999-1 VDE 0609-1 / Connecting devices – Electrical copper conductors – Safety requirements for screw-type and screwless-type clamping units – Part 1: General requirements and particular requirements for clamping units for conductors from 0.2 mm <sup>2</sup> up to 35 mm <sup>2</sup>	

## Tests and Testing Procedures per IEC/EN Standards

Products such as connecting devices, rail-mount terminal blocks and connectors, etc., have their own product-specific test specifications. The following sections describe the most important tests and are limited to a description of the test procedures and an explanation of the test purpose. The data shown (e.g., voltages, temperatures, forces) only serve as illustration and may differ depending on the test.

### Mechanical Tests

All WAGO products meet requirements for the following mechanical tests:

#### • Termination Requirements

##### Conductor Termination

Two WAGO connection systems are proven in the field of Spring Pressure Connection Technology:

The **PUSH WIRE®** connection for applications requiring solid conductors (e.g., for lighting and building wiring, telecommunications, house communication or alarm systems).

Conductor range:

0.2 ... 4 mm<sup>2</sup> / 24 ... 12 AWG

The **universal CAGE CLAMP®** spring pressure connection system for solid, stranded and fine-stranded conductors, designed for a variety of industrial, electrical and electronic applications (e.g., fine-stranded conductors in the elevator industry, in power stations, in the chemical and automotive industry, and aboard ships).

Conductor range:

0.08 ... 35 mm<sup>2</sup> (28 ... 2 AWG)

The **Push-in CAGE CLAMP®** connection takes universal CAGE CLAMP® connections further by allowing the termination of 0.2 ... 16 mm<sup>2</sup> (24 ... 6 AWG) solid, stranded and fine-stranded conductors (25 mm<sup>2</sup>/4 AWG only "f-st") and offering all the benefits and safety of the original CAGE CLAMP®. Furthermore, the Push-in CAGE CLAMP® connection technology allows solid, stranded and fine-stranded conductors with ferrules from 0.5 to 16 mm<sup>2</sup> (20 ... 6 AWG) to be terminated by simply pushing them in.

The conductor entry hole is perfectly suited for the insulation diameter of the rated conductor cross section, thus providing good conductor guidance.

This is particularly important for vibration-prone applications.

Fine-stranded conductors of a small or very small size are highly flexible, and deform when pushed against the conductor stop in terminal blocks. As a result, the conductor insulation – not the copper conductor – may be clamped, causing intermittent contact or no contact at all.

In order to prevent conductor insulation from being inserted into the clamp, insulation stops are available for WAGO rail-mount terminal blocks up to 4 mm<sup>2</sup> (12 AWG), even providing protection for 0.08 mm<sup>2</sup> (28 AWG) conductors.

### Rated Cross Sections and Connectable Conductors

I. Per IEC 60999-1 / EN 60999-1 / VDE 0609-1, Table 1:

Rated Cross Section	Theoretical Largest Conductor Diameter							Connectable Conductor	
	Metric			AWG				Rigid	Flexible
	Rigid		Flexible	Rigid		Flexible			
	Solid	Stranded			<sup>b)</sup> Solid	<sup>b)</sup> Class B Stranded	<sup>c)</sup> Class I, K, M Stranded		
mm <sup>2</sup>	mm	mm	mm	Conductor Size	mm	mm	mm		
0.2	0.51	0.53	0.61	24	0.54	0.61	0.64	To be defined in the corresponding product standard	
0.34	0.63	0.66	0.8	22	0.68	0.71	0.8		
0.5	0.9	1.1	1.1	20	0.85	0.97	1.02		
0.75	1	1.2	1.3	18	1.07	1.23	1.28		
1	1.2	1.4	1.5	–	–	–	–		
1.5	1.5	1.7	1.8	16	1.35	1.55	1.6		
2.5	1.9	2.2	2.3 <sup>a)</sup>	14	1.71	1.95	2.08		
4	2.4	2.7	2.9 <sup>a)</sup>	12	2.15	2.45	2.7		
6	2.9	3.3	3.9 <sup>a)</sup>	10	2.72	3.09	3.36		
10	3.7	4.2	5.1	8	3.34	3.89	4.32		
16	4.6	5.3	6.3	6	4.32	4.91	5.73		
25	–	6.6	7.8	4	5.45	6.18	7.26		
35	–	7.9	9.2	2	6.87	7.78	9.02		

NOTE: The diameters of the largest rigid and flexible conductors are based on Table 1 of IEC 60228 A/IEC 60344 and on ASTM B172-71 [4], IEC Publication S-19-81 [5], IEC Publication S-66-524 [6], as well as IEC Publication S-66-516 [7] for AWG conductors.

<sup>a)</sup> Dimensions for Class 5 flexible conductors only (IEC 60228 A)

<sup>b)</sup> Nominal diameter +5%

<sup>c)</sup> Largest diameter for conductors of classes I, K, M + 5%

In practical use, the conductor cross sections are approximately 5% below the values stated in the table!

The IEC 60999-1/EN 60999-1/VDE 0609-1 Specification (Section 7.1) requires that:

**Clamping units must be able to connect unprepared conductors.**

Under normal operating conditions, direct clamping (i.e., directly connecting a conductor to the terminal block's current bar) provides optimal contact quality, because all risk factors arising from anti-splaying methods are prevented.

Occasionally, conductor anti-splaying protection may be required, including various methods (see illustrations below).

Special requirements apply only in special application areas exposed to extremely corrosive atmospheres.

In this case, we recommend using either solid copper conductors or fine-stranded copper conductors with properly crimped, tin-coated copper ferrules or copper pin terminals.

As with solid copper conductors, the fine strands are crimped into a dense inner core. Crimping prevents ingress of aggressive atmospheres (depending on the ppm concentration), which can diffuse into the conductor bundle along the individual strands and deposit between individual strands and the clamping point.

#### One Conductor per Clamping Unit

A number of DIN VDE, EN, IEC directives mandate or recommend that only one conductor must be connected per clamping unit.

In accordance with DIN VDE 0611, Part 4, 02.91, Section 3.1.9, multi-level distribution rail-mount terminal blocks must be dimensioned so that a single (solid, stranded or fine-stranded) conductor of the nominal cross section can be connected at each terminal point.

Other VDE, EN and IEC specifications also recommend the connection of only one conductor per clamping unit, unless the clamping unit is specifically tested and approved for the connection of several conductors, for example:

VDE 0609, Part 1, 12.00 / EN 60999-1:2000/ IEC 60999-1:1999, Section 7.1  
VDE 0660, Part 600, 06.12 / EN 61439-1:2011 / IEC 61439-1, Section 8.6.3  
VDE 0113, Part 1, 06.07 / EN 60204-1:2006 / IEC 60204-1:2016, Section 13.1.1.

One conductor per clamping unit is therefore recommended to meet the safety requirements of these relevant specifications. This WAGO principle is the basis for a number of other technical and economic advantages:

- Each conductor may be terminated or removed without affecting previously connected conductors.
- Where re-wiring is required, only the conductor to be changed is removed from the clamping point, all other conductors remain safely clamped.
- Each conductor is clamped independently.
- Any conductor size combination can be connected.

WAGO rail-mount terminal blocks offer different solutions to increase the number of clamping points.

The most common way is by branching one conductor into two or three conductors. WAGO offers 3- and 4-conductor terminal blocks, making additional jumpers unnecessary.

## II. Per IEC 60999-2, Table 1:

Rated Cross-Section	Theoretical Largest Conductor Diameter					Connectable Conductor	
	Metric		AWG/kcmil				
	Rigid Stranded	Fine-Stranded <sup>a)</sup>	Gauge	Rigid Stranded	Fine-Stranded	Rigid	Flexible
mm <sup>2</sup>	mm	mm		mm	mm		
50	9.1	11	1/0	9.64	12.08	To be defined in the corresponding product standard	
70	11	13.1	2/0	11.17	13.54		
95	12.9	15.1	3/0	12.54	15.33		
–	–	–	4/0	14.08	17.22		
120	14.5	17	250	15.34	19.01		
150	16.2	19	300	16.8	20.48		
185	18	21	350	18.16	22.05		
–	–	–	400	19.42	24.05		
240	20.6	24	500	21.68	26.57		
300	23.1	27	600	23.82	30.03		

Dimensions for Class 5 flexible conductors only (IEC 60228 A)

NOTE: The diameters of the largest rigid and flexible conductors are based on Table 1 and Table 3 of IEC 3 A/IEC 60228 and on ASTM B172-71 [1], IEC Publication S-19-81 [2], IEC Publication S-66-524 [3], as well as IEC Publication S-66-516 [7] for AWG conductors.



Tip-bonded conductor



Tin-plated copper ferrule (gas-tight crimped)



Ultrasonically bonded conductor



Crimped pin terminal (gas-tight), preferably made of copper with a tin-plated surface

Anti-splaying methods require a terminal block one size larger than the nominal cross section of the conductor to be terminated. Ferruled conductor cross sections specified for individual products are based on WAGO's Variocrimp square crimping technology. Gas-tight, crimped twin ferrules may be used, provided the ferrule is inserted all the way into the clamping unit and that there is a sufficient clearance and creepage distance between adjacent potentials.

## Tests and Testing Procedures per IEC/EN Standards (continued)

### Mechanical Tests (continued)

#### • Pull-Out Test per IEC/EN 60947-7-1, IEC/EN 60998-2-2, IEC/EN 60999-1

The pull-out test simulates the mechanical stress on the clamping unit when, for example, the installer pushes the conductor aside to better access/operate the adjacent clamping unit, or verifies if the conductor is connected properly by briefly pulling on it.

During the test, a pulling force is applied without jerking, for one minute, to the connected conductor. The pulling force is selected according to the cross-sectional area. The larger the cross section of the conductor, the higher the pull-out force that is selected. For example, the pulling force is 40 N for a conductor having a cross section of 1.5 mm<sup>2</sup> (16 AWG) and 100 N for a conductor with a cross section of 16 mm<sup>2</sup> (6 AWG). The values specified by these standards are the same for both screw clamp and spring clamp terminal blocks. During the test, the conductor must neither slip out of the clamping unit, nor break near the clamping unit.

#### Conductor Pull-Out Forces

The clamping units of screwless terminal blocks must withstand the pull-out forces as follows:

IEC 60947-1/EN 60947-1/VDE 0660-100, Table 5:

Low-voltage switchgear and controlgear, General rules

IEC 60947-7-1/EN 60947-7-1/

VDE 0611-1, Rail-mount terminal blocks for copper conductors

IEC 60998-2-1/EN 60998-2-1/

VDE 0613-2-1, Table 104:

IEC 60998-2-2/ EN 60998-2-2

VDE 0613-2-2, Table 103:

Connecting devices for low-voltage circuits for household and similar purposes

Particular requirements for connecting devices as separate entities with screw-clamp or screwless terminal blocks.

IEC 60999-1/EN 60999-1/VDE 0609-1, Table 3:

IEC 60999-2/EN 60999-2/VDE 0609-101, Table 2:

Safety requirements for screw-clamp and screwless clamping units for electrical copper conductors

Rated Cross-Section		Pull-Out Forces per IEC/EN		
mm <sup>2</sup>	AWG/kcmil	60947-7-1	60998-2-2	60999-1/-2
		N	N	N
0.2	24	10	10	10
0.34	22	15	15	15
0.5	20	20	20	20
0.75	18	30	30	30
1	–	35	35	35
1.5	16	40	40	40
2.5	14	50	50	50
4	12	60	60	60
6	10	80	80	80
10	8	90	90	90
16	6	100	100	100
25	4	135	135	135
–	3	156		
35	2	190	190	190
–	1	236		
50	1/0	236		236
70	2/0	285		285
95	3/0	351		351
–	4/0	427		427
120	250	427		427
150	300	427		427
185	350	503		503
–	400	503		503
240	500	578		578
300	600	578		578

• Shock Test per IEC/EN 60068-2-27; IEC/EN 61373 (Railway Applications)

The shock test is similar to the vibration test except that, instead of continuous vibrations, single shocks are applied to the specimen. Shock tests are usually performed with an acceleration of 20g, for example, over a period of 11 ms. Tests for special requirements often call for much higher values.

Like the vibration tests, shock tests are primarily used to test the voltage drop variation or contact breaks, etc.

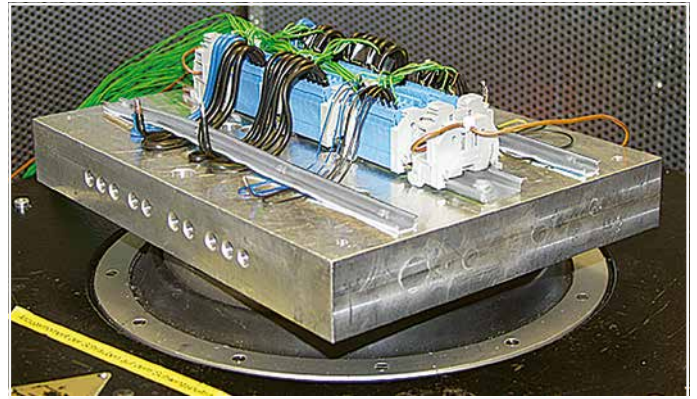
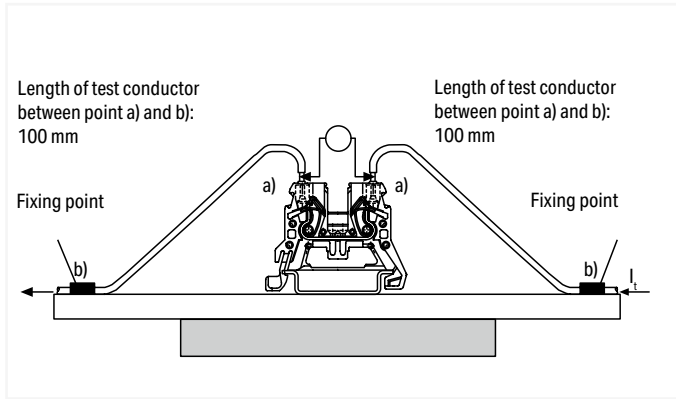

**Example: Shock requirement**  
 per IEC/EN 60068-2-27 (half-sine shock)  
 100g acceleration, 6 ms duration  
 Shock direction: 3 axes (3 shocks each in positive and negative direction)

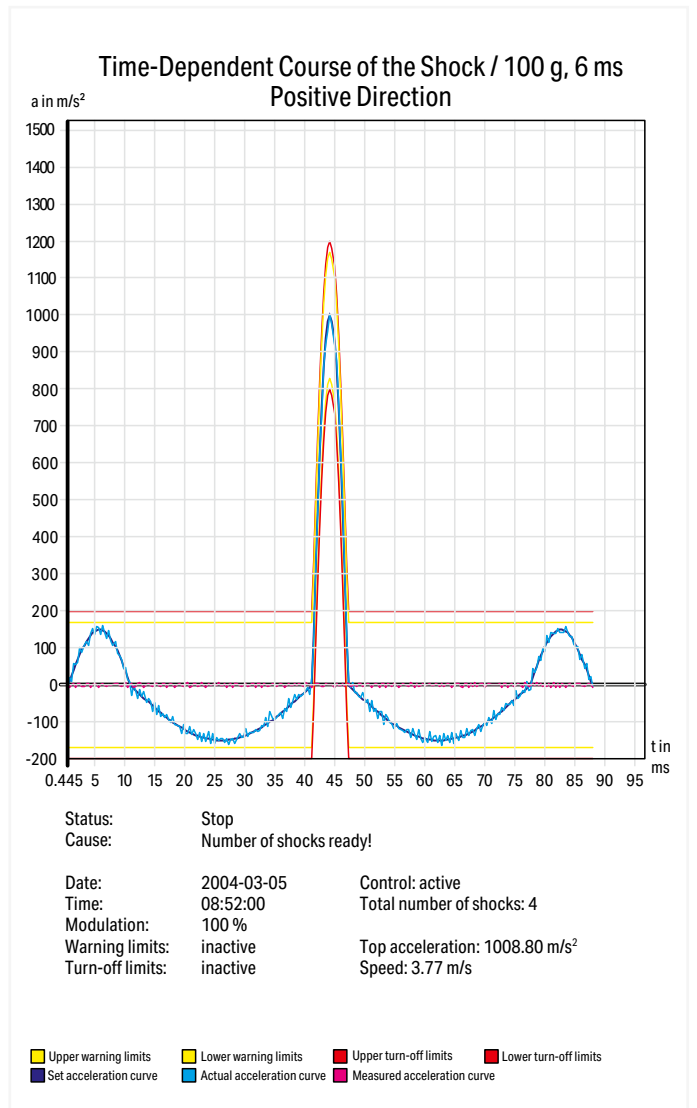
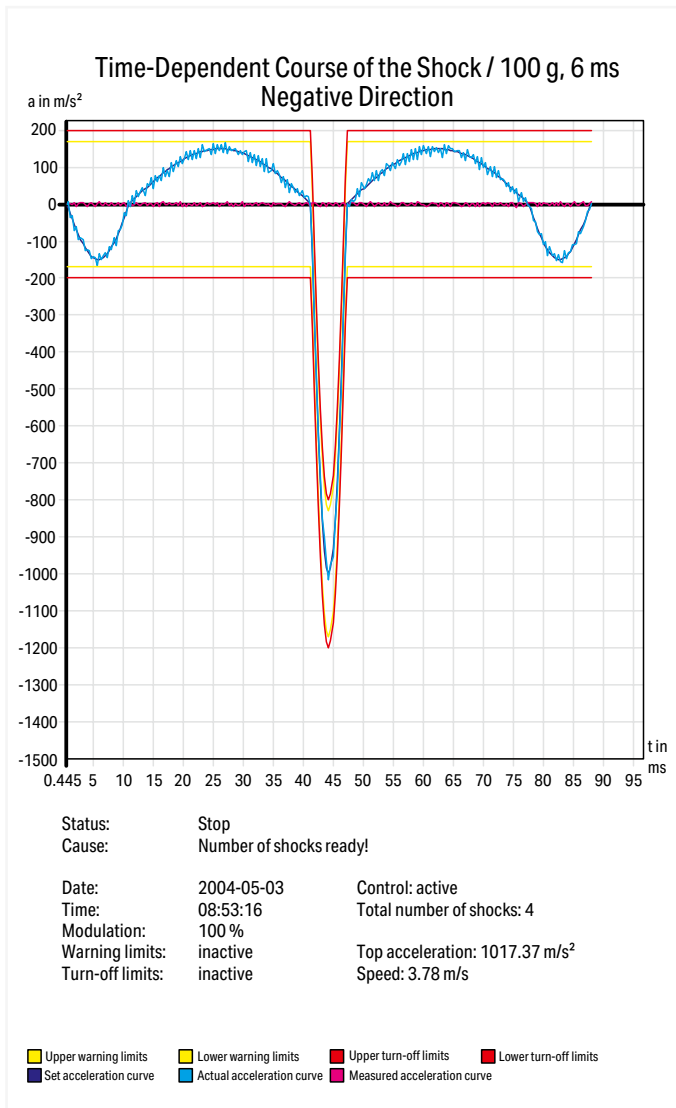

## Tests and Testing Procedures per IEC/EN Standards (continued)

### Mechanical Tests

- Vibration Test per IEC/EN 60068-2-6; DNV GL, LR (Marine Applications); EN 61373 (Railway Applications)

The vibration test determines whether vibrations, such as those produced in the vicinity of machines or in vehicles, will permanently affect the electrical connection, or if contact breaks will occur during vibrations. Using a vibration table, the test specimen is subjected to vibration in each of the X, Y and Z axes (see pictures).

The amplitude, acceleration and, in particular, the frequency of the vibration must vary during the test.

In a common test procedure, for example, a wide frequency band is continuously run up to 2000 Hz, at different accelerations up to 20g and different amplitudes up to 20 mm. Test duration is 90 minutes per axis.



Other test types are performed using a single fixed frequency. The exact test procedure may vary considerably, depending on how the product will be used. Some test specifications require the determination of possible resonant frequencies, i.e., determining if resonance occurs within the frequency spectrum to be passed through. Analyzing the specimen behavior under the influence of resonant frequencies is performed using a special testing procedure.

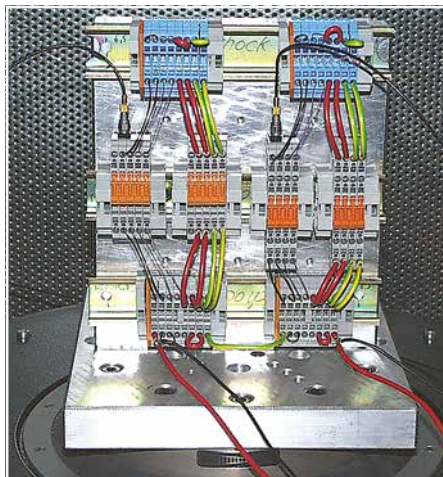

Beyond these standard procedures, each market segment performs additional testing. Examples include railway authorities testing rolling electrical equipment, or the testing performed multiple marine agencies (e.g., DNV GL Group, Lloyd's Register of Shipping). Though the requirements of such testing procedures are particularly demanding, test arrangements are identical for all of them. During vibrations, possible contact breaks are monitored on an oscilloscope. Voltage drop is measured before and after the test to detect permanent failures, i.e., checking if electrical resistance at the clamping unit has not increased beyond the permissible limit. The smaller this value is, the smaller the contact resistance of the clamping unit.

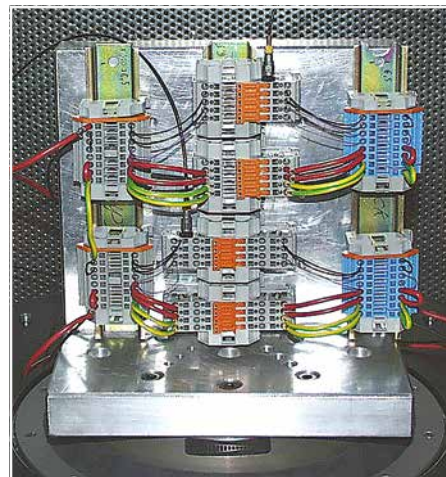

The test is passed if:

- the conductor has neither slipped out of the terminal block nor been damaged
- the maximum permissible voltage drop has not been exceeded
- and neither contact breaks have occurred nor a defined break time has been exceeded.

The test specimen must not be damaged in any way that might affect future use.

Since their inception, both CAGE CLAMP® and Push-in CAGE CLAMP® connections have been routinely tested for their resistance to vibration in connection with approval tests.

Additionally, WAGO conducts special self-resonance behavior tests on clamping systems, using different terminal block and conductor arrangements. In these tests, a wide frequency band is continuously run up to 2000 Hz, at different accelerations up to 20g and different amplitudes up to 20 mm. The figure provides an example of a self-resonance vibration test configuration.

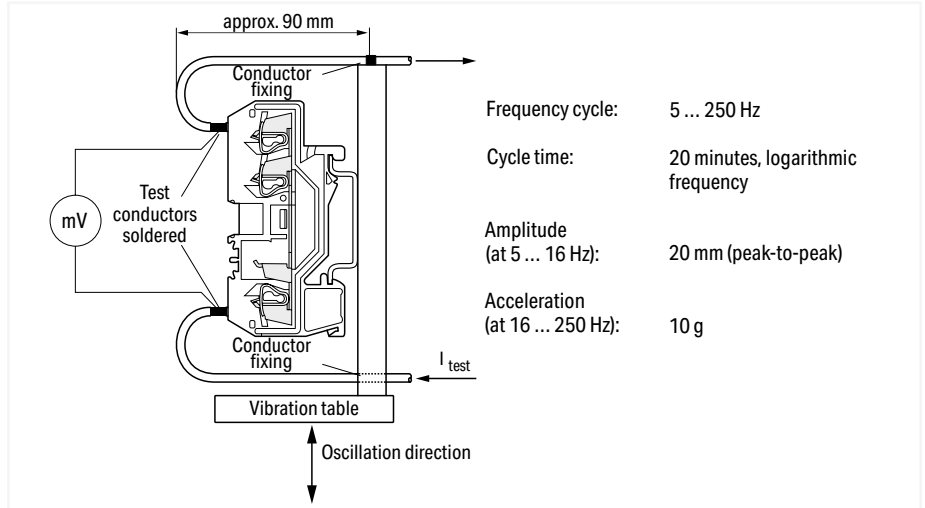

Frequency cycle: 5 ... 250 Hz  
 Cycle time: 20 minutes, logarithmic frequency  
 Amplitude (at 5 ... 16 Hz): 20 mm (peak-to-peak)  
 Acceleration (at 16 ... 250 Hz): 10 g

Self-resonance vibration test set-up

All WAGO spring clamp connections meet these test requirements.

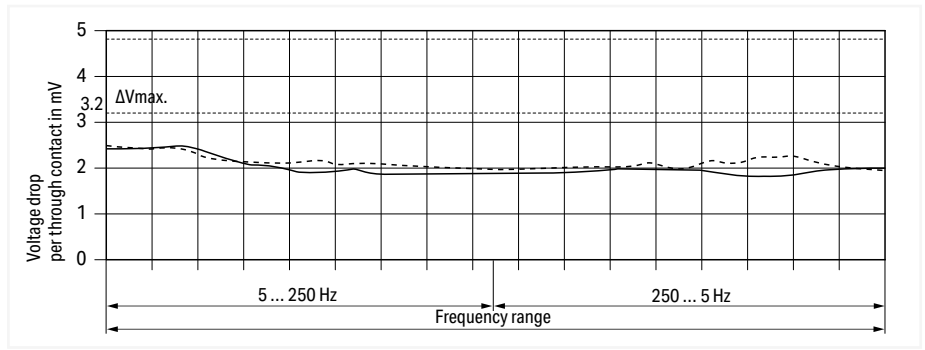

Frequency cycle  
 Rail-mount terminal block: Item no. 280-681  
 Test current: 1/10 I<sub>N</sub> = 2,4 A  
 ----- Test specimen no. 1  
 - - - - - Test specimen no. 2

## Tests and Testing Procedures per IEC/EN Standards (continued)

### Electrical Tests

All WAGO products meet requirements for the following electrical tests:

- Temperature-Rise Test per IEC/EN 60947-7-1

The temperature-rise test examines the clamping unit – including the surrounding insulation – at rated current, over-current and short-circuit current levels.

Unless otherwise specified in the related equipment specification, e.g., by specifying the nominal currents of the equipment, terminal blocks and connectors are tested with current loads as specified in the respective construction specification.

For rail-mount terminal blocks complying with IEC 60947-7-1/EN 60947-7-1/VDE 0611-1, or terminal blocks complying with IEC 60998-1/EN 60998-1/ VDE 0613-1, the temperature rise must not exceed 45 Kelvin.

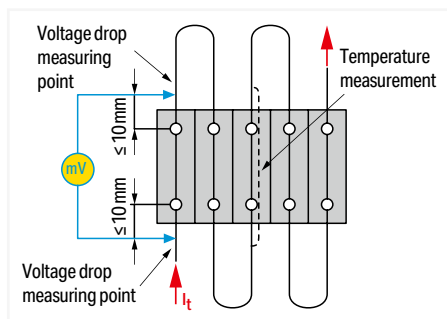

Test arrangement: "Temperature-Rise Test"

Rated Cross-Section	Test Current per IEC/EN		Conductor Size	Test Current per IEC/EN
	60947-7-1 Table 4	60998-1 Table 2		
mm <sup>2</sup>	A	A	AWG/kcmil	A
0.2	4	4	24	4
0.34	5	5	22	6
0.5	6	6	20	8
0.75	9	9	18	10
1	13.5	13.5	-	16
1.5	17.5	17.5	16	16
2.5	24	24	14	22
4	32	32	12	29
6	41	41	10	38
10	57	57	8	50
16	76	76	6	67
25	101	101	4	90
35	125	125	2	121
-			1	139
50	150		1/0	162
70	192		2/0	185
95	232		3/0	217
-			4/0	242
120	269		250 kcmil	271
150	309		300 kcmil	309
185	353		350 kcmil	353
240	415		500 kcmil	415
300	520		600 kcmil	520

#### • Current-Carrying Capacity Curve per IEC/EN 60512-5-2

Both the design requirements and the current-carrying capacity of a connector must be checked by the user when selecting connectors. This data depends on the following factors: connected conductor cross section, surrounding air temperature, number of simultaneously loaded poles, connector's internal resistance, as well as PCB layout and connector materials if required. In accordance with IEC/EN 60512-5-2, the relationship between current, surrounding air temperature and temperature rise up to the connector's upper temperature limit is illustrated via current-carrying capacity curve. The connector must only be operated up to this temperature limit (sum of the self-generated heat and the surrounding air temperature) without being damaged or destroyed during operation.

Functioning of a current-carrying capacity curve per EN 60512-5-2 is shown by an application using a current-carrying capacity curve for the X-COM®-SYSTEM:

This application requires each pole of a 4-pole connector be subjected to a load of 32 A. Based on the basic curve determined for this pole number with a conductor cross section of 4 mm<sup>2</sup>, it has been determined the maximum surrounding air temperature is 42°C (107.6°F). The current must be reduced at higher surrounding air temperatures, e.g., to 19 A at an surrounding air temperature of 80°C (176°F).

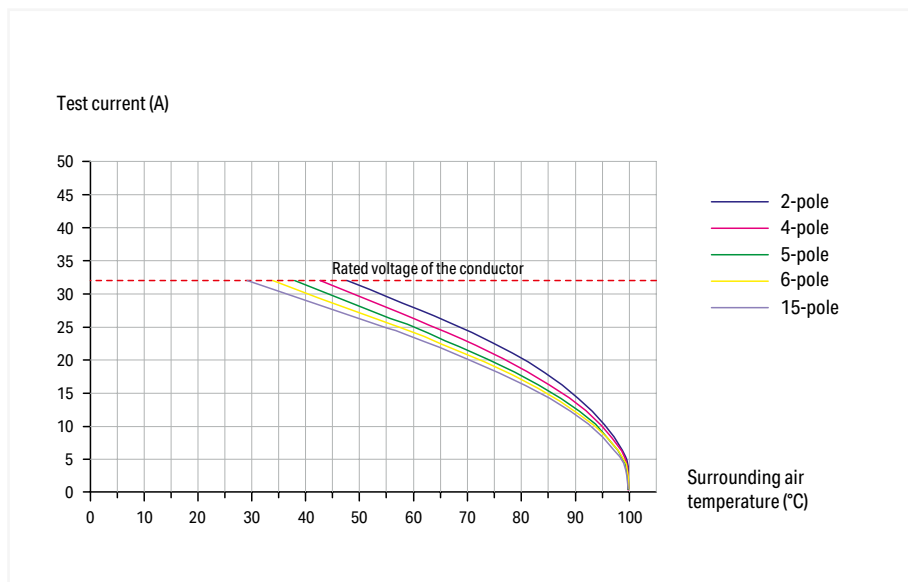

1-conductor/1-pin carrier terminal block (769-176)  
Conductor cross section: 4 mm<sup>2</sup> (12 AWG)

1-conductor female plugs (769-102 to 769-115)  
Conductor cross section: 4 mm<sup>2</sup> (12 AWG)  
Conductor loop length: 1 m

## Tests and Testing Procedures per IEC/EN Standards (continued)

### Electrical Tests (continued)

#### • Voltage Drop Test per IEC/EN 60947-7-1

The voltage drop test evaluates clamping point quality under stress such as vibration, temperature change, industrial climate and salt spray, in order to verify that the contact point is gas-tight.

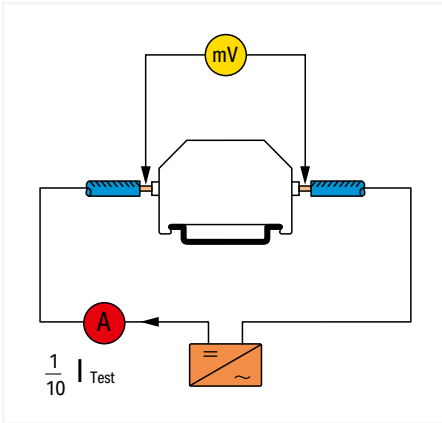

The CAGE CLAMP® and Push-in CAGE CLAMP® connections enclose and contain fine-stranded conductors. Therefore, a variation of the voltage drop with solid and fine-stranded conductors is so small that its influence may be negligible for the practical application of the terminal blocks.

Test arrangement: "Voltage Drop Test"

Typical voltage drop variations for solid and fine-stranded conductors of 280 to 285 Series CAGE CLAMP® Rail-Mount terminal Blocks:

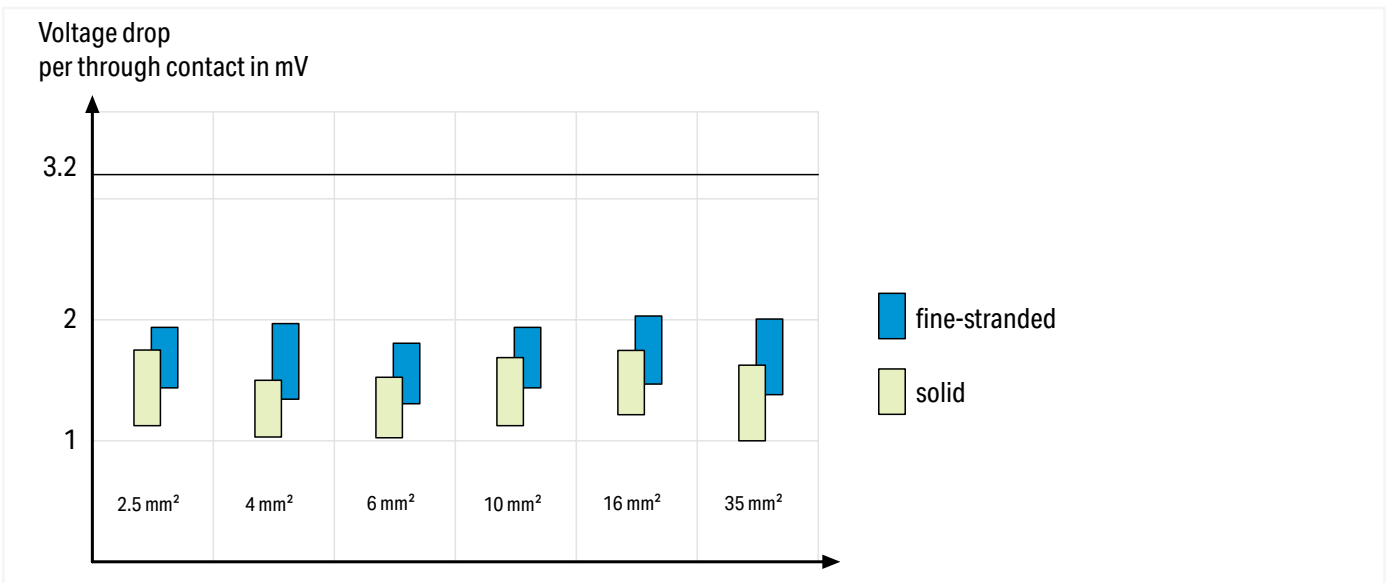

Example: Current load cycling test result for rail-mount terminal blocks (item no. 285-195) using 95 mm² (4/0 AWG) fine-stranded copper conductors:

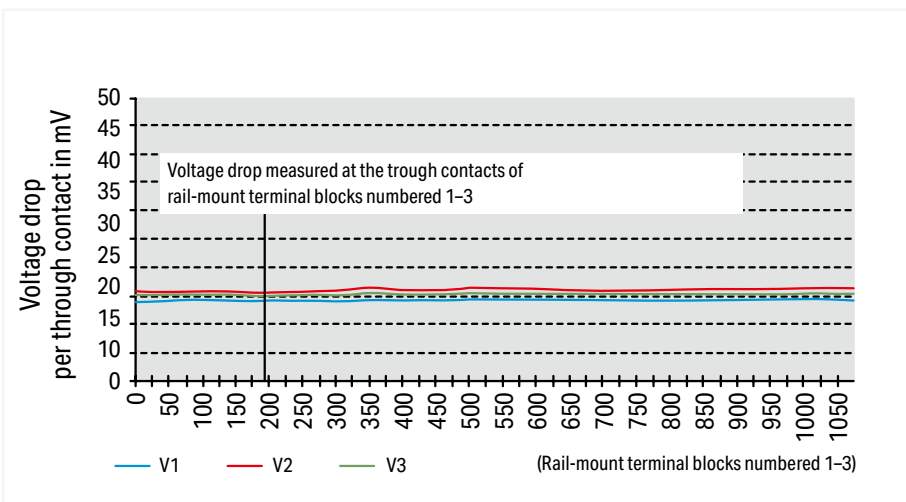

Voltage drop variation over longer periods under current load cycling conditions is shown for WAGO 285-195 (95 mm²/4/0 AWG) Rail-Mount Terminal Blocks using solid copper conductors. The diagram shows that the voltage drop is constant, far beyond the 192 cycles required in IEC 60947-7-1.

(The voltage drop was determined at the rated current.)

- Short-Time Withstand Current Test (Short-Circuit Withstand Capacity) per IEC/EN 60947-7-1

Apart from the rated current that can be constantly applied to an electrical device, operation-related short peak currents consistently occur in electrical installations, e.g., when motors are started. Also, in the event of a short circuit, a high current can flow for a short time until the fuse element melts. Terminal blocks and connecting devices must be able to withstand such conditions. For example, in the short-time withstand current test per IEC/EN 60947-7-1, a through rail-mount terminal blocks must be capable of withstanding for one second the rated short-time withstand current which corresponds to  $120 \text{ A/mm}^2$  of its nominal cross section.

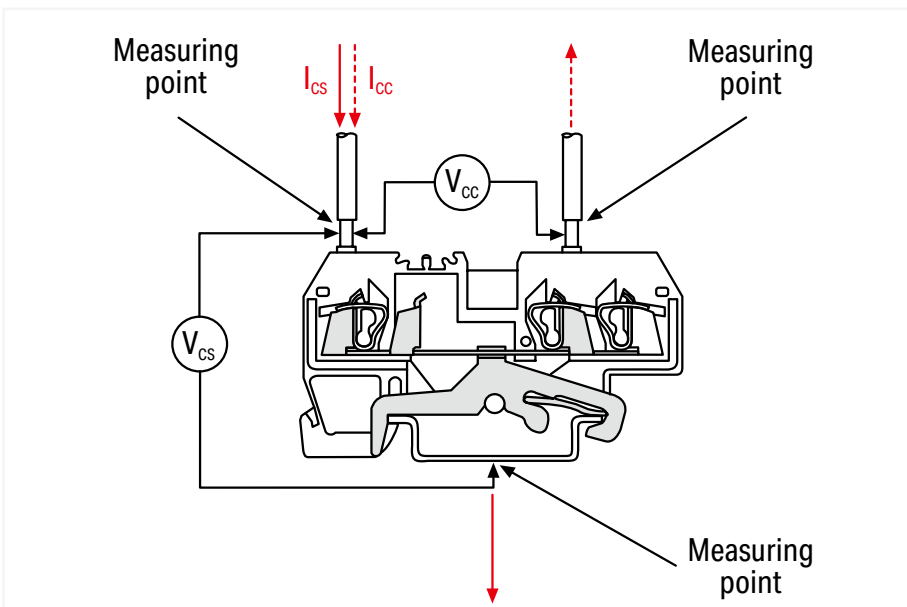
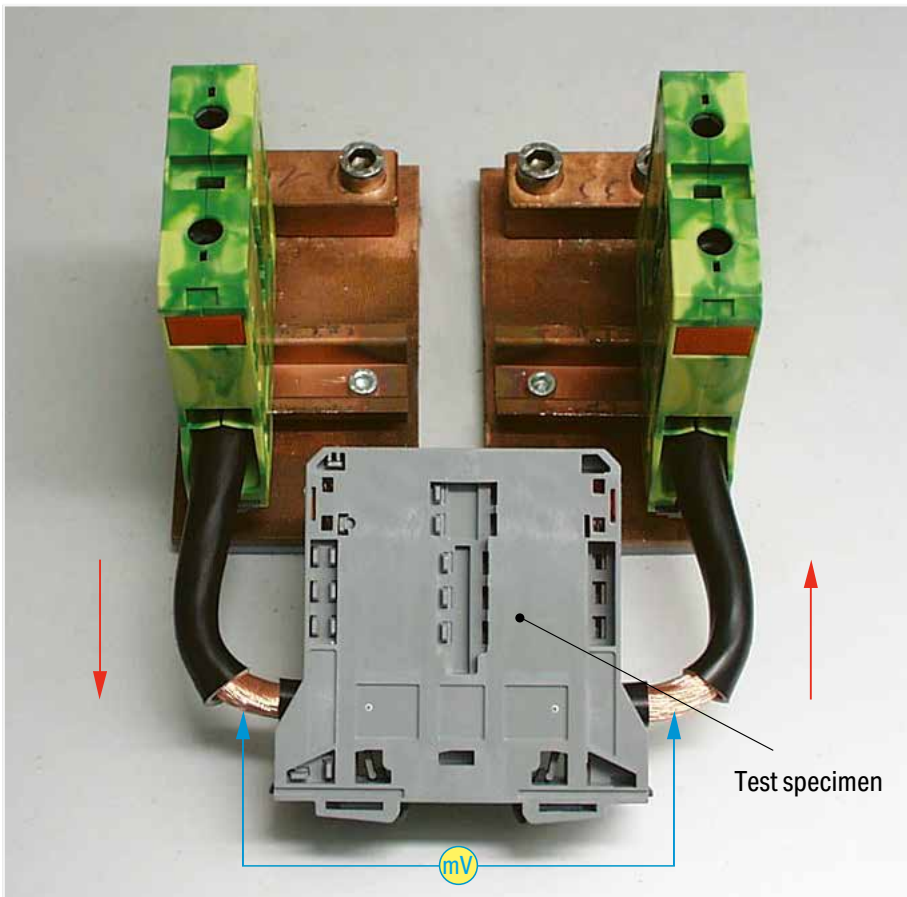

During the short-time withstand current test, the ground conductor rail-mount terminal blocks are subjected three times for one second each to a current load of  $120 \text{ A/mm}^2$ . The pass criterion for the test is the voltage drop (limiting value and constant measured values).

## Tests and Testing Procedures per IEC/EN Standards (continued)

### Electrical Tests (continued)

#### • Insulation Parameters per IEC/EN 60664-1

##### Clearances and Creepage Distances

The following generally applies:

The equipment specification contains data for the measurement of clearances and creepage distances, or refers to the data contained in the new revised edition of the basic standard DIN EN 60664-1/VDE 0110-1. This standard contains new clearances and creepage distances in compliance with insulation coordination requirements. That is, the insulation parameters of equipment are assigned to:

- the anticipated surge voltages
- the parameters of the protection device against impulse voltage
- the anticipated environmental conditions and the protection measures against pollution.

This standard is based on IEC 60604-1.

##### Overvoltage Categories for Electrical Equipment:

A specific overvoltage category must be defined on the basis of the following, general description:

- Equipment in **overvoltage category I** is intended to be connected to the fixed electrical installations of buildings. Protective means are taken outside the equipment – either in the fixed installation or between the fixed installation and the equipment – to limit transient overvoltages to the specific level.
- Equipment in **overvoltage category II** is to be connected to the fixed electrical installations of buildings.  
**Note:** Examples of such equipment are household appliances, portable tools and similar loads.
- Equipment in **overvoltage category III** is part of the fixed electrical installations and other equipment where a higher degree of availability is expected.  
**Note:** Examples of such equipment are distribution boards, circuit breakers, wiring systems (IEV 826-16-08, including cables, bus bars, junction boxes, switches, socket outlets) in the fixed installation and equipment for industrial use and other equipment, e.g., stationary motors with permanent connection to the fixed installation.
- Equipment in **overvoltage category IV** is for use in or near the feed-in of electrical building installations upstream of the main distribution board in the direction of the network.  
**Note:** Examples include electricity meters, primary overcurrent protection devices and ripple control units.

#### Clearances, Rated Surge Voltages, Overvoltage Categories, Pollution Degrees

Surge voltages (Table 1) are a decisive factor in determining clearances.

The basis forms the **overvoltage category**, i.e., the allocation of the equipment to the expected overvoltage, and the **conductor-ground voltage** derived from the nominal mains voltage in installations with a grounded Y (star) point.

In ungrounded installations, or installations where the conductor is not grounded, the voltage between conductors is applicable in the same way as conductor voltage to ground.

The rated surge voltage must be selected from Table F.1 corresponding to the overvoltage category specified and to the rated voltage of the equipment.

Table F.1 – Rated Surge Voltage for Equipment Energized Directly from the Low-Voltage Mains (DIN EN 60664-1/VDE 0110-1)

Voltage Curve: 1.2/50  $\mu$ s per IEC 60060-1/VDE 0432-1

Nominal voltage of the power supply system <sup>1)</sup> (mains) per IEC 60038 <sup>2)</sup>		Conductor-to-neutral voltage, derived from the nominal AC or DC voltage up to and including: V	Rated surge voltage <sup>2)</sup>			
Three-phase V	Single-phase V		Overvoltage category <sup>4)</sup>			
			I V	II V	III V	IV V
		50	330	500	800	1500
		100	500	800	1500	2500
	120 ... 240	150 <sup>5)</sup>	800	1500	2500	4000
230 / 400 277 / 480		300	1500	2500	4000	6000
400 690		600	2500	4000	6000	8000
1000		1000	4000	6000	8000	12000

<sup>1)</sup> See Annex B for application to existing different low-voltage mains and their nominal voltages.

<sup>2)</sup> Equipment with these rated impulse voltage levels can be used in installations complying with IEC 60364-4-443.

<sup>3)</sup> The / mark indicates a 3-phase, 4-conductor system. The lower value is the conductor-to-neutral voltage, while the higher value is the conductor-to-conductor voltage. Where only one value is indicated, it refers to 3-phase, 3-conductor systems and specifies the conductor-to-conductor voltage.

<sup>4)</sup> See 4.3.3.2.2 for an explanation of the overvoltage categories.

<sup>5)</sup> The nominal voltages for single-phase systems in Japan are 100 V or 100 ... 200 V. The value for the rated impulse voltage is, however, derived from the voltage gaps conductor-to-neutral for a voltage level of 150 V (see Annex B).

The nominal supply voltage and the corresponding rated impulse voltage values apply for grounded and ungrounded circuits.

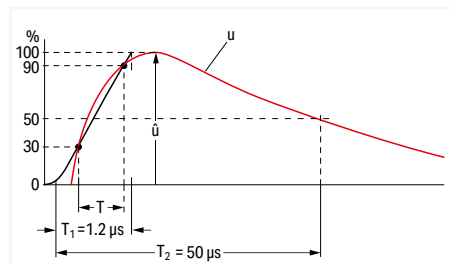

Voltage pulse: 1.2/50  $\mu$ s per EN 60060-1/VDE 0432-1

## Pollution Degrees

Pollution factors are all solid, liquid or gaseous foreign matter which may reduce the dielectric strength or the specific surface resistance. Factors are divided into four classes based on expected environmental conditions:

		Examples of pollution degrees for assigned areas:
Pollution degree 1:	No pollution, or only dry, non-conductive pollution occurs. Pollution has no influence.	Open, unprotected insulated equipment in air-conditioned or clean, dry rooms
Pollution degree 2:	Only non-conductive pollution occurs. Occasional, temporary conductivity caused by condensation can also be expected.	Open, unprotected insulated equipment in occupied areas, shops, laboratories, mechanical workshops and medical rooms.
Pollution degree 3:	Conductive pollution occurs, or dry, non-conductive pollution occurs which will become conductive due to condensation.	Open, unprotected insulated equipment in industrial, business and farming areas (e.g., unheated rooms, workshops and boiler rooms)
Pollution degree 4:	The pollution generates persistent conductivity caused by conductive dust, rain or wet conditions.	Open, unprotected insulated equipment for outdoor use

## Dimensioning Clearances

(DIN EN 60664-1/VDE 0110-1, Table F.2)

Select the minimum clearances in accordance with the rated surge voltages and pollution degrees. To maximize the operating life of the equipment, do not go below these minimum clearances.

Table F.2 contains a list of information for Case A, the inhomogeneous field and for Case B, the homogeneous field.

This involves an electric field with essentially constant (Case B) or non-constant (Case A) voltage gradients between the electrodes.

**Equipment with a clearance that is dimensioned per Case A, in other words rated for the most unfavorable case, requires no verification by the impulse voltage test.**

Equipment with a clearance that is dimensioned per Case B, or between A and B, requires verification by the impulse voltage test.

The clearances shown in Table F.2 are applicable for an installation height of up to 2000 m above sea level.

Values for clearances above 2000 m must be multiplied by a high correction factor in accordance with Table A.2.

**Table F.2 – Clearances to Withstand Transient Overvoltages**  
DIN EN 60664-1/VDE 0110-1

Required Impulse Withstand Voltage <sup>1)5)</sup>	Minimum Clearances in Air up to 2000 m Above Sea Level					
	Case A Inhomogeneous Field (see 3.15)			Case B Homogeneous Field (see 3.14)		
	Pollution Degree <sup>6)</sup>			Pollution Degree <sup>6)</sup>		
kV	1 mm	2 mm	3 mm	1 mm	2 mm	3 mm
0.33 <sup>2)</sup>	0.01	0.2 <sup>3)4)</sup>	0.8 <sup>4)</sup>	0.01	0.2 <sup>3)4)</sup>	0.8 <sup>4)</sup>
0.4	0.02			0.02		
0.5 <sup>2)</sup>	0.04			0.04		
0.6	0.06			0.06		
0.8 <sup>2)</sup>	0.10			0.10		
1	0.15			0.15		
1.2	0.25	0.25	0.2	0.3	0.3	
1.5 <sup>2)</sup>	0.5	0.5	0.45	0.45		
2	1	1	1	0.6	0.6	
2.5 <sup>2)</sup>	1.5	1.5	1.5	0.8	0.8	
3	2	2	2	1.2	1.2	1.2
4 <sup>2)</sup>	3	3	3	1.5	1.5	1.5
5	4	4	4	2	2	2
6 <sup>2)</sup>	5.5	5.5	5.5	3	3	3
8 <sup>2)</sup>	8	8	8	3.5	3.5	3.5
10	11	11	11	4.5	4.5	4.5
12 <sup>2)</sup>	14	14	14	5.5	5.5	5.5
15	18	18	18	8	8	8
20	25	25	25	10	10	10
25	33	33	33	12.5	12.5	12.5
30	40	40	40	17	17	17
40	60	60	60	22	22	22
50	75	75	75	27	27	27
60	90	90	90	35	35	35
80	130	130	130	45	45	45
100	170	170	170			

<sup>1)</sup> This voltage is for:

- Functional insulation: the maximum impulse voltage expected to occur across the clearance (see 5.1.5)
- Basic insulation directly exposed to or significantly influenced by transient overvoltages from the low-voltage mains (see 4.3.3.3, 4.3.3.4.1 and 5.1.6): the rated impulse voltage for the equipment;
- Other basic insulation (see 4.3.3.4.2): the highest impulse voltage that can occur in the circuit

For reinforced insulation, see 5.1.6.

<sup>2)</sup> Preferred values specified in 4.2.3

<sup>3)</sup> For printed wiring material, the values for pollution degree 1 apply, except that the value must not be less than 0.04 mm, as specified in Table F.4.

<sup>4)</sup> The minimum clearances given for pollution degree 2 and 3 are based on the reduced withstand characteristics of the associated creepage distance under humidity conditions (see IEC 60664-5).

<sup>5)</sup> For parts or circuit within equipment subject to surge voltages based on 4.3.3.4.2, interpolation of values is allowed. However, standardization is achieved by using the preferred series of impulse voltage values based on 4.2.3.

<sup>6)</sup> The dimensions for pollution degree 4 are as specified for pollution degree 3, except that the minimum clearance is 1.6 mm.

## Tests and Testing Procedures per IEC/EN Standards (continued)

### Electrical Tests (continued)

#### • Insulation Parameters per IEC/EN 60664-1 (continued)



#### Creepage Distances, Rated Voltages, Material Groups

Criteria for dimensioning creepage distances are the rated voltages, pollution degrees and material groups.

The pollution degrees specified for the clearances, and its quoted allocation to locations, is also applicable for creepage distances.

Tables F.3 a and F.3 b of DIN EN 60664-1/ VDE 0110-1 contain the rated voltages that have to be considered for dimensioning the minimum creepage distances.

Table F.3a – Single-Phase, 3- or 2-Conductor, AC or DC Systems

Nominal Voltage of the Power Supply System (Mains)*	Voltages for Table F.4	
	For insulation conductor-to-conductor <sup>1)</sup>	For insulation conductor-to-ground <sup>1)</sup>
	All systems 	Three-conductor systems, center-point grounded 
V	V	V
12.5	12.5	
24 25	25	
30	32	
42 48 50**	50	
60	63	
30 to 60	63	32
100**	100	
110 120	125	
150**	160	
200	200	
110 to 200	200	100
220	250	
110 to 220 120 to 240	250	
300**	320	
220 to 440	500	250
600**	630	
480 to 960	1000	500
1000**	1000	

<sup>1)</sup> Conductor-to-ground insulation level for non-grounded or impedance-grounded systems equals that for conductor-to-conductor, as the operating voltage to ground of any conductor can, in practice, approach full conductor-to-conductor voltage. This is because the actual voltage to ground is determined by the insulation resistance and capacitive reactance of each conductor to ground; thus, low (but acceptable) insulation resistance of one conductor can in effect ground it and raise the other two to full conductor-to-conductor voltage to ground.

\*For the relationship to rated voltage, see 4.3.2.

\*\*These values correspond to the values given in Table F.1.

Altitude m	Standard Air Pressure (in kPa)	Multiplier for Clearances
2000	80	1
3000	70	1.14
4000	62	1.29
5000	54	1.48
6000	47	1.7
7000	41	1.95
8000	35.5	2.25
9000	30.5	2.62
10000	26.5	3.02
15000	12	6.67
20000	5.5	14.5

Table F.3b – Single-Phase, 4- or 3-Conductor AC Systems

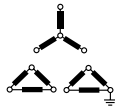
Nominal Voltage of the Power Supply System (Mains)*	Voltages for Table F.4		
	For insulation conductor-to-conductor <sup>1)</sup>	For insulation conductor-to-ground <sup>1)</sup>	
	All systems	Three-phase, 4-conductor systems with grounded neutral conductor <sup>2)</sup>	Three-phase, 3-conductor systems, non-grounded <sup>1)</sup> or grounded conductor
V	V		
V	V	V	V
60	63	32	63
110 120 127	125	80	125
150**	160		160
200	200		200
208	200	125	200
220 230 240	250	160	250
300**	320		320
380 400 415	400	250	400
440	500	250	500
480 500	500	320	500
575	630	400	630
600**	630		630
660 690	630	400	630
720 830	800	500	800
960	1000	630	1000
1000**	1000		1000

<sup>1)</sup> Conductor-to-ground insulation level for non-grounded or impedance-grounded systems equals that for conductor-to-conductor, as the operating voltage to ground of any conductor can, in practice, approach full conductor-to-conductor voltage. This is because the actual voltage to ground is determined by the insulation resistance and capacitive reactance of each conductor to ground; thus, low (but acceptable) insulation resistance of one conductor can in effect ground it and raise the other two to full conductor-to-conductor voltage to ground.

<sup>2)</sup> For equipment used on both three-phase, 4-conductor and three-phase, 3-conductor systems, grounded and non-grounded, use only the values for 3-conductor systems.

\*For the relationship to rated voltage, see 4.3.2.

\*\*These values correspond to the values given in Table F.1.

**Material Groups**

Insulation materials are classified into four groups according to their Comparative Tracking Index (CTI) as follows:

Material Group I:  $600 \leq \text{CTI}$

Material Group II:  $400 \leq \text{CTI} < 600$

Material Group IIIa:  $175 \leq \text{CTI} < 400$

Material Group IIIb:  $100 \leq \text{CTI} < 175$

The CTI values above refer to values obtained in accordance with DIN EN 60664-1/VDE 0110-1 on samples specially made for this purpose and tested with Solution A.

## Tests and Testing Procedures per IEC/EN Standards (continued)

### Electrical Tests (continued)

- Insulation Parameters per IEC/EN 60664-1 (continued)

**Table F.4 – Creepage Distances to Avoid Failure due to Tracking**  
DIN EN 60664-1/VEDE 0110-1

Voltage <sup>1)</sup> (RMS)	Minimum Creepage Distances								
	Printed Circuits		Pollution Degree						
	Pollution Degree		Pollution Degree						
	1 All Material Groups mm	2 All Material Groups except IIIb mm	1 All Material Groups mm	2 Material Group I mm	2 Material Group II mm	2 Material Group III mm	3 Material Group I mm	3 Material Group II mm	3 Material Group III <sup>2)</sup> mm
V									
10	0.025	0.04	0.08	0.4	0.4	0.4	1	1	1
12.5	0.025	0.04	0.09	0.42	0.42	0.42	1.05	1.05	1.05
16	0.025	0.04	0.1	0.45	0.45	0.45	1.1	1.1	1.1
20	0.025	0.04	0.11	0.48	0.48	0.48	1.2	1.2	1.2
25	0.025	0.04	0.125	0.50	0.5	0.5	1.25	1.25	1.25
32	0.025	0.04	0.14	0.53	0.53	0.53	1.3	1.3	1.3
40	0.025	0.04	0.16	0.56	0.8	1.1	1.4	1.6	1.8
50	0.025	0.04	0.18	0.6	0.85	1.2	1.5	1.7	1.9
63	0.04	0.063	0.2	0.63	0.9	1.25	1.6	1.8	2
80	0.063	0.1	0.22	0.67	0.95	1.3	1.7	1.9	2.1
100	0.1	0.16	0.25	0.71	1	1.4	1.8	2	2.2
125	0.16	0.25	0.28	0.75	1.05	1.5	1.9	2.1	2.4
160	0.25	0.4	0.32	0.8	1.1	1.6	2	2.2	2.5
200	0.4	0.63	0.42	1	1.4	2	2.5	2.8	3.2
250	0.56	1	0.56	1.25	1.8	2.5	3.2	3.6	4
320	0.75	1.6	0.75	1.6	2.2	3.2	4	4.5	5
400	1	2	1	2	2.8	4	5	5.6	6.3
500	1.3	2.5	1.3	2.5	3.6	5	6.3	7.1	8 (7.9) <sup>4)</sup>
630	1.8	3.2	1.8	3.2	4.5	6.3	8 (7.9) <sup>4)</sup>	9 (8.4) <sup>4)</sup>	10 (9) <sup>4)</sup>
800	2.4	4	2.4	4	5.6	8	10 (9) <sup>4)</sup>	11 (9.6) <sup>4)</sup>	12.5 (10.2) <sup>4)</sup>
1000	3.2	5	3.2	5	7.1	10	12.5 (10.2) <sup>4)</sup>	14 (11.2) <sup>4)</sup>	16 (12.8) <sup>4)</sup>
1250			4.2	6.3	9	12.5	16 (12.8) <sup>4)</sup>	18 (14.4) <sup>4)</sup>	20 (16) <sup>4)</sup>
1600			5.6	8	11	16	20 (16) <sup>4)</sup>	22 (17.6) <sup>4)</sup>	25 (20) <sup>4)</sup>
2000			7.5	10	14	20	25 (20) <sup>4)</sup>	28 (22.4) <sup>4)</sup>	32 (25.6) <sup>4)</sup>
2500			10	12.5	18	25	32 (25.6) <sup>4)</sup>	36 (28.8) <sup>4)</sup>	40 (32) <sup>4)</sup>
3200			12.5	16	22	32	40 (32) <sup>4)</sup>	45 (36) <sup>4)</sup>	50 (40) <sup>4)</sup>
4000			16	20	28	40	50 (40) <sup>4)</sup>	56 (44.8) <sup>4)</sup>	63 (50.4) <sup>4)</sup>
5000			20	25	36	50	63 (50.4) <sup>4)</sup>	71 (56.8) <sup>4)</sup>	80 (64) <sup>4)</sup>
6300			25	32	45	63	80 (64) <sup>4)</sup>	90 (72) <sup>4)</sup>	100 (80) <sup>4)</sup>
8000			32	40	56	80	100 (80) <sup>4)</sup>	110 (88) <sup>4)</sup>	125 (100) <sup>4)</sup>
10000			40	50	71	100	125 (100) <sup>4)</sup>	140 (112) <sup>4)</sup>	160 (128) <sup>4)</sup>
12500			50 <sup>3)</sup>	63 <sup>3)</sup>	90 <sup>3)</sup>	125 <sup>3)</sup>			
16000			63 <sup>3)</sup>	80 <sup>3)</sup>	110 <sup>3)</sup>	160 <sup>3)</sup>			
20000			80 <sup>3)</sup>	100 <sup>3)</sup>	140 <sup>3)</sup>	200 <sup>3)</sup>			
25000			100 <sup>3)</sup>	125 <sup>3)</sup>	180 <sup>3)</sup>	250 <sup>3)</sup>			
32000			125 <sup>3)</sup>	160 <sup>3)</sup>	220 <sup>3)</sup>	320 <sup>3)</sup>			
40000			160 <sup>3)</sup>	200 <sup>3)</sup>	280 <sup>3)</sup>	400 <sup>3)</sup>			
50000			200 <sup>3)</sup>	250 <sup>3)</sup>	360 <sup>3)</sup>	500 <sup>3)</sup>			
63000			250 <sup>3)</sup>	320 <sup>3)</sup>	450 <sup>3)</sup>	600 <sup>3)</sup>			

<sup>1)</sup> This voltage is for:

- Functional insulation; the working voltage
- Basic and supplementary insulation of the circuit energized directly from the mains (see 4.3.2.2.1): for the voltage rationalized through Table F.3a or F.3b, based on the rated voltage of the equipment, or the rated insulation voltage
- Basic and supplementary insulation of systems, equipment and internal circuits not energized directly from the mains (see 4.3.2.2.2): the highest rms voltage which can occur in the system, equipment or internal circuit when supplied at rated voltage and under the most taxing combination of operation conditions within equipment rating

<sup>2)</sup> Material group IIIb is not recommended for applications in pollution degree 3 above 630 V.

<sup>3)</sup> Provisional data based on extrapolation. Technical committees who have other information based on experience may use their dimensions.

<sup>4)</sup> The values in brackets must only be applied for reducing creepage distances if a rib is used (see 5.2.5).

The high degree of accuracy of the creepage distances given in the table does not imply that the measuring accuracy must be of the same quality.

Depending on the intended use, WAGO's terminal blocks, splicing and pluggable connectors are suitable for pollution degrees 2 or 3 and for overvoltage categories II or III.

Example:

**WAGO Rail-Mount Through Terminal Blocks**

per IEC 60947-7-1/

EN 60947-7-1/VDE 0611-1, these blocks have the following ratings:

800 V / 8 kV / 3

Rated voltage: 800 V

Rated surge voltage 8 kV

Pollution Degree 3

Overvoltage category III

WAGO's connectors for household and similar mounted installations are rated per IEC 60998-1 / EN 60998-1 / VDE 0613-1, Table 3.

Example:

**WAGO PUSH WIRE® Connectors for Junction Boxes**

According to this standard, these connectors are rated for:

\*400 V / 4 kV / 2

\*grounded circuits

Rated voltage: 400 V

Rated surge voltage 4 kV

Pollution Degree 2

Overvoltage category II

**Table 3 – Clearances and Creepage Distances**  
(IEC/EN 60998-1)

Rated Insulation Voltage V	Clearances/Creepage Distances mm
≤ 130	1.5
> 130 and ≤ 250	3
> 250 and ≤ 450	4
> 450 and ≤ 750	6
> 750	8

## Tests and Testing Procedures per IEC/EN Standards (continued)

### Electrical Tests (continued)

- Power-Frequency Withstand Voltage Test per IEC/EN 60947-7-1, IEC/EN 60947-1

This testing procedure verifies creepage distances. Creepage distances, i.e., the distances of creeping currents, are caused by conductive impurities on the surface of the insulation housing. Apart from the amount of impurities to which a terminal block is subjected, for example, the plastic material and housing design are also involved in generating creeping currents. The insulation material of the housing may be carbonized by a creeping current, which further increases conductivity.

The specimen is tested using a power-frequency withstand voltage for a short time. For example, a rail-mount terminal block designed to operate at 800 V nominal voltage is usually tested using 2000 V alternating voltage for one minute. The test is passed if no flashovers or breakdowns have occurred.

- Rated Impulse Withstand Voltage Test per IEC/EN 60947-7-1, IEC/EN 60947-1

This test verifies the clearances of a product. In simplified terms, clearance is the distance between two poles of a terminal block. If this distance is too small, voltage peaks may cause flashovers or breakdowns. The arrangement of the rated impulse withstand voltage test is identical to that of the power frequency withstand voltage test; the test voltages, however, are comparatively higher and the testing times shorter, e.g., 9.8 kV over 50  $\mu$ s (see figure).

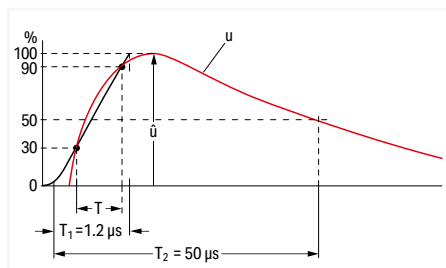

Voltage pulse: 1.2/50  $\mu$ s per EN 60060-1/VDE 0432-1

Voltage pulse: measurement curve (red) and auxiliary curve (black) for calculating the rate of rise of the pulse and the resulting (virtual) peak of the curve.

- T: Time interval for calculating the rate of rise
- T1: Front time (duration between start of impulse and reaching the peak)
- T2: Total pulse duration

The test values are the values at sea level as specified in the relevant test specification. The values indicated in the catalog correspond to an altitude of 2000 m. The test is passed if no flashovers or breakdowns have occurred.

- IP Ratings for Electrical Equipment per IEC/EN 60529

Alphanumeric Nomenclature for Type of Protection			IP vs. NEMA		
Code letters IP	Protection against accidental contact and against the penetration of foreign objects or water	IP (Ingress Protection) = International degree of protection		IP Code	NEMA
First code number 0 to 6	Indicates the degree of protection against accidental contact and the penetration of foreign objects.	If indicating the degree of protection requires only one digit, the other (second) digit must be substituted for with an X.		10	1
Second code number 0 to 8	Indicates the degree of protection against water penetration.			11	2
First code number:		54	3	14	3R
IP0X	No protection against accidental contact or the penetration of foreign objects	54	3S	54	3S
IP1X	Protection against foreign objects > 50 mm	55	4&4X	55	4&4X
IP2X	Protection against foreign objects > 12 mm (e.g., finger)	52	5	67	6&6P
IP3X	Protection against foreign objects > 2.5 mm	52	5	52	12&12K
IP4X	Protection against foreign objects > 1 mm	54	13	54	13
IP5X	Protection against damaging dust deposits	IPX0	No protection against water		
IP6X	Protection against dust penetration	IPX1	Protection against vertically falling water		
		IPX2	Protection against diagonally dripping water (15° angle)		
		IPX3	Protection against water spray		
		IPX4	Protection against water spray		
		IPX5	Protection against water jet, e.g., from a nozzle		
		IPX6	Protection against flooding		
		IPX7	Protection against temporary immersion		
		IPX8	Protection against continuous immersion		
		IPX9	Protection against high-pressure and high-temperature water jets		

## Tests and Testing Procedures per IEC/EN Standards (continued)

### Material Tests

All WAGO products meet requirements for the following material tests:

- Needle Flame Test per IEC/EN 60947-7-1, IEC/EN 60695-11-5

This test simulates flames that may arise under certain conditions (e.g. fault current over a creepage distance, overloading of parts or components). Nearby parts can also be affected by such flames.

Not only the ignition of the test specimen resulting from an intrinsic defect is tested, but also its behavior when other parts ignite.

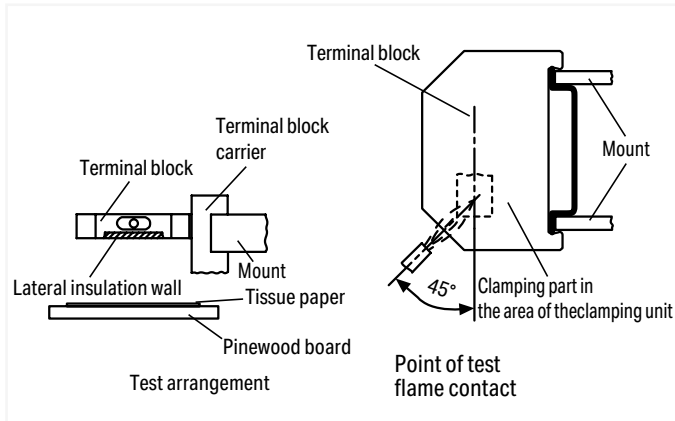

Flames must not be fuelled by the insulation materials used, thus creating a larger fire. The test specimen is exposed to a standard gas flame during a defined time period (e.g., ten seconds).

After the test flame has been removed, the specimen must self-extinguish within 30 seconds. Furthermore, a layer of tissue paper located beneath the specimen must not be ignited by glowing particles falling from the specimen.

- Glow-Wire Test per IEC/EN 60998-1, IEC/EN 60695-2-11

In the event of failure, a high current may cause a conductor to glow.

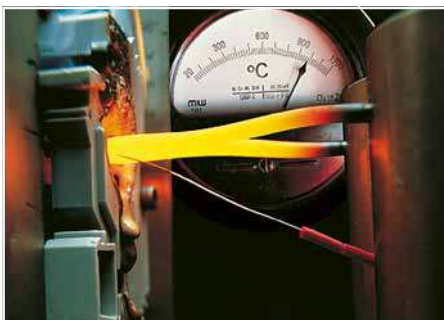

However, the glowing conductor shall not cause ignition of the product involved (e.g., a rail-mount terminal block). For the glow-wire test, the tip of the glow-wire is pressed against a surface of the test specimen (see picture).

The position of the test specimen, surface to be tested, test duration and glow-wire temperature (e.g., 960°C/1760°F over 30 seconds, or 850°C/1562°F over 5 seconds) are specified in the standards.

The specimen must be positioned such that the tip of the glow-wire acts on the surface section of the specimen (vertical surface of the specimen) that is most likely to be exposed to thermal loading during normal use.

As the highest temperature in the event of a fault is anticipated at the contact insert/wire connection, the tip of the glow-wire must act upon the section of the insulation housing that is the closest to this contact point.

The test is passed if there are no visible flames or permanent glowing, or if flames or glowing extinguish within 30 seconds after removal of the glow-wire. Furthermore, a layer of tissue paper located beneath the specimen must not be ignited by glowing particles falling from the specimen.

## Tests and Testing Procedures per IEC/EN Standards (continued)

### Environmental Tests

The following tests show how a product reacts when exposed to an aggressive environment. Climatic chambers simulate standard atmospheres that could impact the long-term consistency of clamping units.

All WAGO products meet the requirements of the following environmental tests:

- Temperature Cycling Test per IEC/EN 60947-7-1, IEC/EN 60998-2-2

This test shows the change of voltage drop over longer periods under temperature cycling conditions. The test procedure usually consists of 192 temperature cycles, for example, each cycle having a duration of 60 minutes (see diagram).

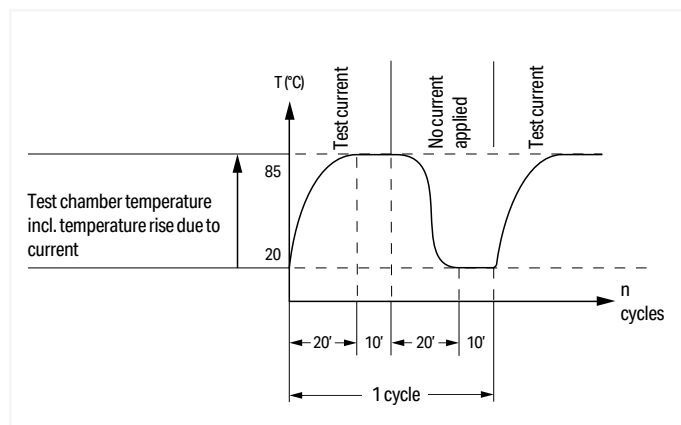

The rated current is applied to the test specimen during temperature rise and when the temperature has reached its maximum value; during the second half of the cycle, the current is zero. Voltage drop is measured every 24 cycles and must not exceed a maximum value or vary greatly. The voltage drop measured at the end of the 192nd cycle must not exceed 1.5 times the value measured after the 24th cycle. After the test, an inspection must show no changes that would impair further use of the product.

- Industrial Atmospheres per EN ISO 6988, IEC/EN 60068-2-42, IEC/EN 60068-2-60

Sulphur and its combustion products are particularly aggressive pollutants commonly found in industrial environments. A test procedure simulating such corrosive conditions consists of exposing a test specimen to water condensation in variable atmospheres containing sulphur dioxide.



A saturated atmosphere is first created in a climatic chamber by heating an aqueous sulphur dioxide solution. After less than half an hour, the test specimen is fully saturated by the condensing vapors and exposed to this atmosphere for eight hours.

After exposure to a humid atmosphere, the test specimen is subjected to dry and cooler conditions at room temperature for 16 hours. Depending on the test severity, the specimen is exposed to both these conditions several times. The gas-tightness of the clamping unit is verified by a voltage drop test.

In other test procedures, products are exposed to a dry corrosive gas atmosphere containing sulfide, nitrogen and sulfur oxides or chloride gas. These tests can be performed over a period of four to 21 days.

• Salt Spray Test per IEC/EN 60068-2-11; DNV GL, LR (Marine Applications)

This test is similar to the test performed in atmospheres with varying water condensation, except that instead of industrial atmospheres, salt mist conditions will be simulated in a heated test chamber (see picture).

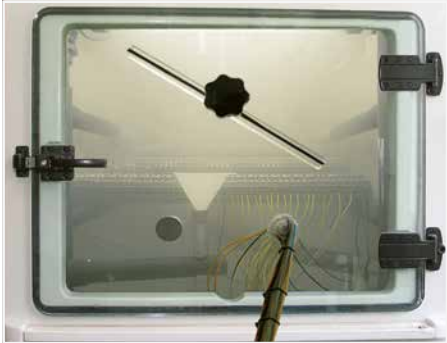

Depending on the test procedure being used, the test specimen is sprayed with salt mist for 16 hours up to 672 hours (4 weeks). Salt spray tests are widely used, especially for marine approvals. However, this test is performed differently than the test procedures described previously for general applications: During a typical test, the test specimen is sprayed with a salt solution for two hours and is then stored for seven days in an atmosphere with a relative humidity between 90 and 95%. This procedure is repeated four times. Voltage drop measurements are used as an evaluation criterion.

• Quick Change of Temperature per IEC/EN 60068-2-14

Without air-conditioning, distribution panels and terminal boxes are exposed to seasonal (and ever-changing) temperature extremes – especially on the open field side. In process technology, for example, a terminal block is exposed to even quicker changes in temperature.

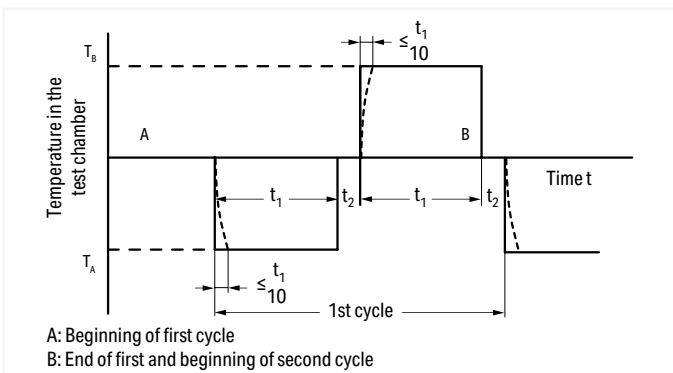

To simulate such conditions, the test specimen is exposed to repeated temperature changes, for example, between  $T_A - 40^{\circ}\text{C}$  ( $-104^{\circ}\text{F}$ ) and  $T_B + 70^{\circ}\text{C}$  ( $+158^{\circ}\text{F}$ ). The dwell time  $t_1$  depends on the thermal capacity of the test specimen and should be between maximum of 3 h and minimum of 10 min and the transition time  $t_2 \dots 3 \text{ min}, 20 \dots 30 \text{ s}$  or less than 10 s. The mechanical and electrical properties of the product are checked at the end of the test.

• Damp Heat, Cyclic (12 + 12 Hour Cycle) per IEC/EN 60068-2-30, DNV GL, LR (Marine Applications)

This test determines the suitability of electrical equipment for use and storage under conditions of high relative humidity when combined with cyclic temperature changes and, in general, producing condensation on the surface of the specimen.

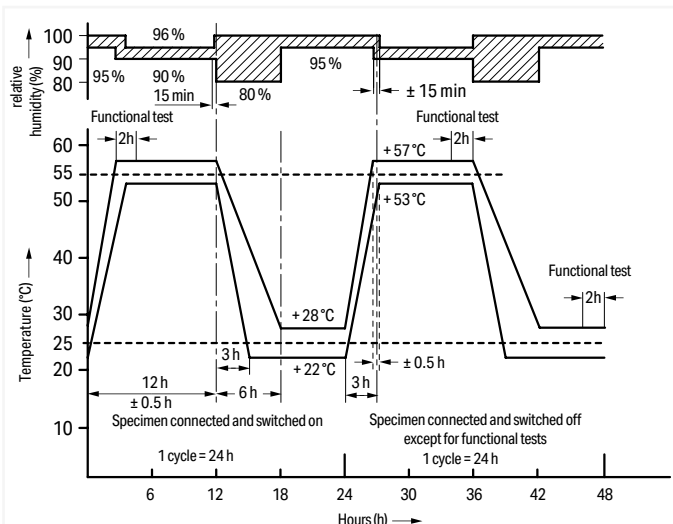

In addition to the salt spray tests, the damp heat test is also used for marine approvals. For this test, the specimens are subjected to temperatures varying cyclically between  $+25^{\circ}\text{C}$  ( $+77^{\circ}\text{F}$ ) and  $+55^{\circ}\text{C}$  ( $+131^{\circ}\text{F}$ ) with a relative humidity of 95% (for tolerances see figure). Functional tests are performed at defined times during the storage period. The mechanical and electrical properties of the product are checked at the end of the test.

## UL Specifications – Underwriters Laboratories, USA

WAGO's terminal blocks and connectors are tested by Underwriters Laboratories Inc. according to one or more of the relevant following UL standards:

- |   |                    |   |
|---|--------------------|---|
| <ul style="list-style-type: none"> <li>• The 273 Series PUSH WIRE® Connectors for Junction Boxes or the 224 Series Lighting Connectors are splicing wire connectors and are certified per UL 486C. These stand-alone devices carry the <b>UL Listing Mark</b> ®.</li> </ul>   | UL 486C            | Splicing wire connectors  |
| <ul style="list-style-type: none"> <li>• Rail-mount terminal blocks or modular terminal blocks (e.g., 280 Series, TOPJOB® S or 260 to 262 Series terminal blocks) are approved as non-stand-alone components per UL 1059 in connection with UL 486E.</li> </ul>   | UL 1059<br>UL 486E | Standard for terminal blocks<br>Equipment wiring terminals for use with aluminum and/or copper conductors |
| <ul style="list-style-type: none"> <li>• The X-COM®-SYSTEM is approved as terminal blocks per UL 1059 standard in connection with UL 486E. It is therefore defined for field and factory wiring with at 300 V.</li> </ul>   |                    |   |
| <ul style="list-style-type: none"> <li>• It is also approved as connectors for use in data, signal, control and power applications per UL 1977 for factory wiring at 600 V (i.e., the clamping unit must be wired under controlled manufacturing conditions).</li> </ul>  | UL 1977            | Component connectors for use in data, signal, control and power applications                              |
| <ul style="list-style-type: none"> <li>• Ex e II terminal blocks are approved to UL 60079-7.</li> </ul>   | UL 60079-7         | Electrical apparatus for explosive gas atmospheres – Part 7: Increased safety                             |
| <ul style="list-style-type: none"> <li>• Ground terminal blocks are tested for grounding and bonding applications per UL 467. Components bearing the <b>UR Recognition Mark</b>  are recognized product. Additionally, after being mounted in their special applications, these components are submitted to an end-product test according to the relevant device or equipment standard.</li> </ul> | UL 467             | Grounding and bonding equipment   |
| <ul style="list-style-type: none"> <li>• Insulation materials are tested for flammability and performance per UL 94.</li> </ul>   | UL 94              | Tests for flammability of plastic materials for parts in devices and appliances                           |

**Tests and Testing Procedures per UL Standards**

All WAGO products meet requirements for the following tests:

- Pull-Out Test per UL 1059, UL 486E (Rail-Mount Terminal Blocks), UL 486C (Splicing Wire Connectors)

In this test, the connected conductors are subjected to the appropriate pull-out forces specified in the following table without jerking for a period of one minute. Different test arrangements are specified for rail-mount terminal blocks and splicing wire connectors.

Conductor Size AWG or kcmil		Pull-Out Force, Pounds (N)					
		UL 486E, Table 22				UL 486C, Table 20	
		Copper		Aluminum		Copper	
	(mm <sup>2</sup> )						
30	(0.05)	0.5	(2.2)	-	-	1.5	(6.7)
28	(0.08)	1	(4.5)	-	-	2	(8.9)
26	(0.13)	2	(8.9)	-	-	3	(13.4)
24	(0.2)	3	(13.4)	-	-	5	(22.3)
22	(0.32)	4.5	(20)	-	-	8	(35.6)
20	(0.52)	6.75	(30)	-	-	10	(44.5)
18	(0.82)	6.75	(30)	-	-	10	(44.5)
16	(1.3)	9	(40)	-	-	15	(66.7)
14	(2.1)	11.5	(50)	-	-	25	(111)
12	(3.3)	13.5	(60)	10	(44)	35	(155)
10	(5.3)	18	(80)	10	(44)	40	(178)
8	(8.4)	20.5	(90)	10	(44)	45	(200)
6	(13.3)	21	(94)	28	(124)	50	(222)
4	(21.2)	30	(133)	36	(160)		
3	(26.7)	35	(156)	42	(187)		
2	(33.6)	42	(186)	50	(222)		
1	(42.4)	53	(236)	61	(271)		
1/0	(53.5)	64	(285)	72	(320)		
2/0	(67.4)	64	(285)	78	(347)		
3/0	(85.0)	79	(351)	97	(432)		
4/0	(107)	96	(427)	116	(516)		
250	(127)	96	(427)	116	(516)		
300	(156)	99	(441)	116	(516)		

Test Arrangement per UL 1059, UL 486E:

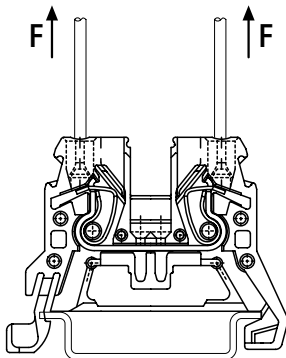

Test Arrangement per UL 486C:

During the test, the conductors must neither slip out of the clamping unit, nor break near the clamping unit.

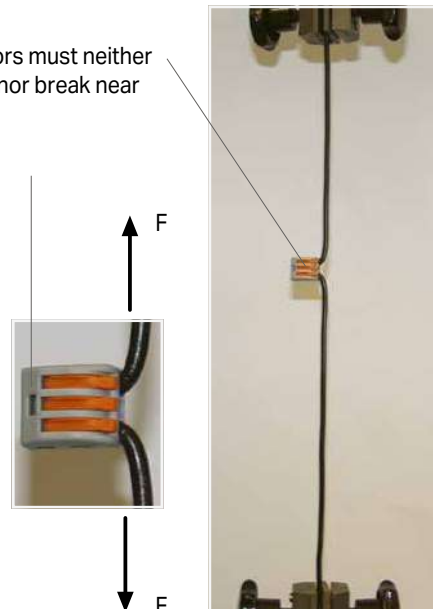

## UL Specifications – Underwriters Laboratories, USA (continued)

### Tests and Testing Procedures per UL Standards (continued)

#### • Heat Cycling Test per UL 1059, UL 486E

Test performed per:

**UL 1059**

Test performed with maximum rated cross section

Test current: 150% of maximum rated current

84 cycles of: 3 1/2 h ON / 1/2 h OFF

The temperature rise is measured after the first and the 84th cycle.

The temperature rise must not exceed 5°C (41°F) after the 84th cycle, compared to the temperature measured after the first cycle.

**UL 486C** (Splicing wire connectors)

**UL 486E** (Equipment wiring terminals)

Test performed with maximum rated cross section

Test current: Increased test current per  
UL 486C, Table 6  
UL 486E, Table 4

500 cycles of: 1 h ON / 1 h OFF  
1 1/2 h ON / 1 1/2 h OFF  
(from 4/0 AWG up to 400 kcmil per UL 486E)

The temperature rises at the terminal blocks and control conductors are measured and recorded after: 1, 25, 50, 75, 100, 125, 175, 225, 275, 350, 425 and 500 cycles.

The temperature rise must not exceed 125°C (257°F) and the stability factor "S" must not exceed ±10.

Conductor Size		Test Current for Copper Conductors in A								
		UL 486E, Table 4						UL 486C, Table 6		
AWG or kcmil	(mm <sup>2</sup> )	Assigned Maximum Ampere Rating <sup>b</sup>	Static Heating <sup>a,c,g</sup>	Heat Cycling Temperature Rating <sup>a</sup>				Static Heating	Heat Cycling	
				75°C (167°F) <sup>d,g</sup>		90°C (194°F) <sup>e,g</sup>				
30	(0.05)	-	3		3.5		4	3	3.5	
28	(0.08)	-	3.5		4		5	3.5	4	
26	(0.13)	-	5.5		6		8	5.5	6	
24	(0.2)	-	7		8		10	7	8	
22	(0.32)	-	9		12		13	9	12	
20	(0.52)	-	12		16		17	12	16	
18	(0.82)	-	17		19		24	17	19	
16	(1.3)	-	18		20		31	18	20	
14	(2.1)	15	[20]	30	[22]	33	[27]	40	30	33
12	(3.3)	20	[25]	35	[28]	39	[40]	54	35	38
10	(5.3)	30	[40]	50	[45]	56	[60]	75	50	56
8	(8.4)	50		70		80		100	70	80
6	(13.3)	65		95		105		131	95	105
4	(21.2)	85		125		140		175		
3	(26.7)	100		145		165		205		
2	(33.6)	115		170		190		240		
1	(42.4)	130		195		220		275		
1/0	(53.5)	150		230		255		320		
2/0	(67.4)	175		265		300		370		
3/0	(85.0)	200		310		345		435		
4/0	(107)	230		360		405		505		
250	(127)	255		405		445		565		
300	(152)	285		445		500		625		

<sup>a</sup> See Section 7.2, 8.2 and 9.2 (UL 486E)

<sup>b</sup> Values are for 75°C (167°F), not more than 3 conductors in raceway or cable ampacities, National Electric Code, ANSI/NFPA 70.

<sup>c</sup> Values are for 75°C (167°F) single conductors in free air ampacities, National Electric Code, ANSI/NFPA 70.

<sup>d</sup> Values are approximately 112% of the static heating test currents.

<sup>e</sup> Values for 8 AWG and larger conductors are approximately 140% of the static heating test currents.

<sup>f</sup> See Section 9.2.4

<sup>g</sup> Values in parentheses apply to connectors with assigned ampere ratings.

• Conditioning – Temperature-Rise Rest per UL 1059, UL 486C

Test performed per:

**UL 1059** (Rail-mount terminal blocks)

**UL 486C**

(Splicing wire connectors)

**Conditioning:**

The clamping units are **pre-wired/pre-inserted nine times** using a conductor with maximum rated cross section. At the tenth time, a new conductor is connected.

After this, a static heating test is performed.

**Static Heating Test:**

Test current: Terminal block rated current

Test current: Increased test current (see Table 6)

Test duration: 30 days

Test duration: 30 days

Max. permissible temperature rise: 30°C (86°F)

Max. permissible temperature rise: 50°C (122°F)

• Grounding and Bonding Equipment per UL 467

When used in grounding and bonding equipment, e.g., terminal blocks, must withstand a short circuit test using the test currents and test durations as specified in Table 5.

In the following example, a 2 AWG (35 mm<sup>2</sup>) ground conductor terminal block (285-635) is tested for 6 seconds at 3900 A.

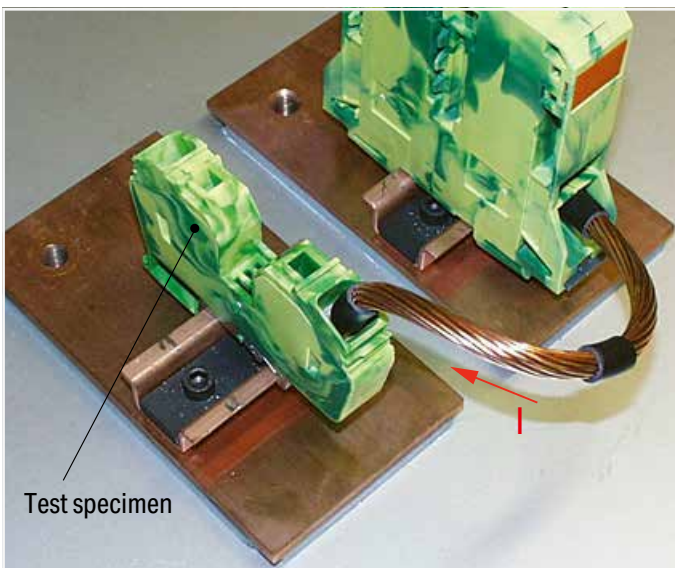

Table 5

Conductor Size Copper		Test Duration	Test Current
AWG	mm <sup>2</sup>	s	A
14	(2.1)	4	300
12	(3.3)	4	470
10	(5.3)	4	750
8	(8.4)	4	1180
6	(13.3)	6	1530
4	(21.2)	6	2450
3	(26.7)	6	3100
2	(33.6)	6	3900
1	(42.4)	6	4900
1/0	(53.5)	9	5050
2/0	(67.4)	9	6400
3/0	(85.0)	9	8030
4/0	(107)	9	10100
250 kcmil	(127)	9	12000

After the test, the specimen must neither show evidence of cracking, breaking or melting, nor any changes in electrical properties.

## UL Specifications – Underwriters Laboratories, USA (continued)

### Tests and Testing Procedures per UL Standards (continued)

#### • Insulation Parameters per UL 1059

The table below shows the potential involved and the corresponding clearances and creepage distances required in different applications.

Table 8.1 – Minimum Acceptable Spacing for Terminal Blocks per UL 1059 Standard

Application:	Potential Involved in Volts	Spacing in inches (mm) between un-insulated live parts of opposite polarity, un-insulated live parts and un-insulated grounded parts other than the enclosure			
		Through Air		Over Surfaces	
A. Dead-front switchboards, panelboards, service equipment and similar applications	51 ... 150 151 ... 300 301 ... 600	1/2 (12.7) 3/4 (19.1) 1 (25.4)	3/4 (19.1) 1-1/4 (31.8) 2 (50.8)		
B. Commercial appliances, including business equipment, electronic data processing equipment and similar applications	51 ... 150 151 ... 300 301 ... 600	1/16 <sup>a</sup> (1.6) <sup>a</sup> 3/32 <sup>a</sup> (2.4) <sup>a</sup> 3/8 (9.5)	1/16 <sup>a</sup> (1.6) <sup>a</sup> 3/32 <sup>a</sup> (2.4) <sup>a</sup> 1/2 (12.7)		
C. Industrial, general	51 ... 150 151 ... 300 301 ... 600	1/8 <sup>a</sup> (3.2) <sup>a</sup> 1/4 (6.4) 3/8 (9.5)	1/4 (6.4) 3/8 (9.5) 1/2 (12.7)		
D. Industrial, devices having limited ratings <sup>b</sup>	51 ... 300 301 ... 600	1/16 <sup>a</sup> (1.6) <sup>a</sup> 3/16 <sup>a</sup> (4.8) <sup>a</sup>	1/8 <sup>a</sup> (3.2) <sup>a</sup> 3/8 (9.5)		
E. Terminal blocks rated 601 ... 1500 V <sup>c</sup>	601 ... 1000 1001 ... 1500	0.55 (14.0) 0.70 (17.8)	0.85 (21.6) 1.20 (30.5)		

#### Notes:

1 A slot, groove, or similar, 0.013 inch (0.33 mm) wide or less in the contour of the insulating material is to be disregarded.

2 Air space of 0.33 mm or less between a live part and an insulating surface is to be disregarded for the purpose of measuring over surface spacing.

<sup>a</sup> The spacing between terminal blocks of opposite polarity and the spacing between a terminal block and a grounded dead metal part shall not be less than 1/4 inch (6.4 mm) if short-circuiting or grounding of such terminal blocks may result from protruding wire strands.

<sup>b</sup> See Section 8.5 (UL 1059)

The spacing values indicated in sub-paragraph D in Table 8.1 are applicable to a terminal block for use only in or with industrial control equipment where the load on any single circuit of the terminal block does not exceed 15 A at 51 ... 150 V, 10 A at 151 ... 300 V, 5 A at 301 ... 600 V or the maximum ampere rating, whichever is less.

<sup>c</sup> Applies only to terminal blocks investigated to Part II of this standard. See Section 22.1 (UL 1059).

#### • Flammability Test per UL 94

This test provides an indication of the material's ability to extinguish a flame, once ignited.

Several ratings can be applied, based on the rated of burning, time to extinguish, ability to resist dripping, and afterglow extinguishing time. Each material tested may receive several ratings, depending on the wall thickness.

UL 94 Rating Categories:

#### V2

- Specimen mounted vertically
- Burning stops within 30 seconds after the flame is removed
- Flaming drips allowed
- Afterglow extinguishes within max. 60 s

#### V1

- Specimen mounted vertically
- Burning stops within 30 seconds after the flame is removed
- No flaming drips allowed
- Afterglow extinguishes within max. 60 s

#### V0

- Specimen mounted vertically
- Burning stops within 10 seconds after the flame is removed
- No flaming drips allowed
- Afterglow extinguishes within max. 30 s

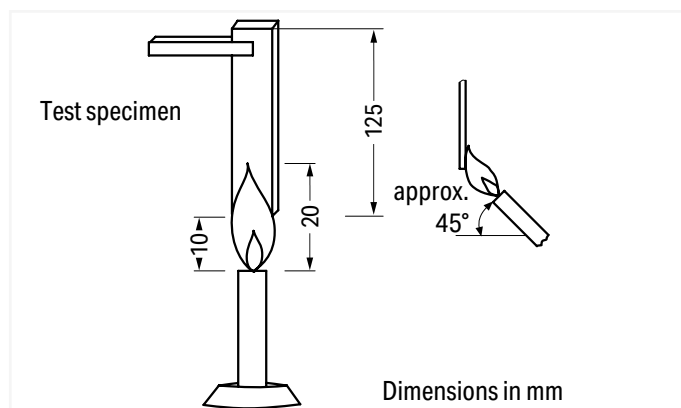

During the test, a 3/4 inch (20 ± 1 mm) flame is applied for two 10-second intervals to the specified bar specimen held vertically.

## "Alu-Plus" Contact Paste

### Terminating aluminum conductors

#### Terminating Aluminum Conductors

WAGO spring clamp terminal blocks are suitable for solid aluminum conductors ① up to 4 mm<sup>2</sup>/12 AWG if WAGO "Alu-Plus" Contact Paste is used for termination.

#### "Alu-Plus" Contact Paste Advantages:

- Automatically destroys the oxide film during clamping.
- Prevents fresh oxidation at the clamping point.
- Prevents electrolytic corrosion between aluminum and copper conductors (in the same terminal block).
- Provides long-term protection against corrosion.

For spring clamp connections with PUSH WIRE® connection technology, WAGO recommends that the aluminum conductor first be cleaned and then immediately inserted into the clamping unit filled with "Alu-Plus" contact paste

Using terminal blocks with CAGE CLAMP® Spring Pressure Connection Technology, aluminum conductors must first be cleaned with a blade and then immediately be inserted into the clamping units filled with "Alu-Plus" Contact Paste.

It is also possible to apply WAGO "Alu-Plus" additionally on the whole surface of the aluminum conductor before termination.

Please note that the nominal currents must be adapted to the reduced conductivity of the aluminum conductors:

2.5 mm<sup>2</sup> (14 AWG) = 16 A  
4 mm<sup>2</sup> (12 AWG) = 22 A

WAGO "Alu-Plus" in the syringe offers a higher degree of reliability and cleanliness when terminating solid aluminum conductors. Filling is quickly performed on selected WAGO connectors and terminal blocks (see pictures).

① Aluminum conductors per IEC 61545 standard, Class B, "Alloy 1370" with 90 ... 180 N/mm<sup>2</sup> tensile strength and 1 ... 4% elongation  
Standard values: 90 ... 180 MPa tensile strength, 1 ... 4% elongation (per EN 615.4.1)



#### WAGO Lighting Connectors

Push nozzle of the "Alu-Plus" syringe first into the circular entry and then into the square conductor entry hole of the WAGO Lighting Connector.



Press plunger down until the "Alu-Plus" has filled both entry holes.

Note: Not suitable for higher temperature applications!



#### WAGO Rail-Mount Terminal Blocks (up to 4 mm<sup>2</sup>/12 AWG)

For each conductor entry: Insert nozzle of the "Alu-Plus" syringe in every open conductor entry hole (one after the other).



Press plunger down until "Alu-Plus" has filled all conductor entry holes.

## Material Specifications

### Insulation materials

WAGO primarily uses polyamide (PA 66 and PA 46) for housing current-conducting parts, as well as polyphthalamide (PPA) and polycarbonate (PC) for insulation material (see table). For more than 50 years, these materials have proven themselves in WAGO products and all are approved by certified, third-party agencies. All listed halogen-free and flame-retardant polymer materials do not contain any heavy metals, silicone, asbestos, or formaldehyde as formulation components.

Table: Standard Insulation Materials

Material	PA 66	PA 66 GF	PPA GF	PA 46	PC	PC
Flammability UL 94 flammability test ratings	V0	V0	V0	V2	V2	V0
Oxygen Index (OI) per EN ISO 4589-2	> 32 %	> 33 %	> 37 %	> 27 %	> 26 %	> 35 %
Glow-wire test per IEC 60695-2-12 GWFI* IEC 60695-2-13 GWIT*	850°C 775°C	850°C 775°C	850°C 775°C	750°C 725°C	800°C 850°C	960°C 850°C
Comparative Tracking Index (CTI) per IEC 60112	600 V	600 V	600 V	375 V	225 V	225 V
Temperature of the ball indentation hardness test per IEC 60695-10-2	≥ 125 °C	≥ 175 °C	≥ 225 °C	n.s.**	≥ 125 °C	≥ 125 °C
RTI impact per UL 746B	105°C	100°C	115°C	115°C	125°C	120°C
Heat deflection temperature (HDT/B) per ISO 75 (bending stress A*: 1.8 MPa; B: 0.45 MPa)	215°C	235°C	285°C	280°C	130°C (1.8 MPa)	130°C (1.8 MPa)
Surface resistivity per IEC 60093	10 <sup>12</sup> Ω	10 <sup>12</sup> Ω	10 <sup>15</sup> Ω	10 <sup>13</sup> Ω	10 <sup>15</sup> Ω	10 <sup>15</sup> Ω
Specific contact resistance per IEC 60093	10 <sup>15</sup> Ω/cm	10 <sup>15</sup> Ω/cm	10 <sup>13</sup> Ω/cm	10 <sup>13</sup> Ω/cm	10 <sup>11</sup> Ω/cm	10 <sup>13</sup> Ω/cm
Dielectric strength per IEC 60243-1	30 kV/mm	40 kV/mm	25 kV/mm	25 kV/mm	25 kV/mm	29 kV/mm

\*Value depends on wall thickness, EN 60335 compliance upon request; \*\*n. s. = not specified

### General Environmental Requirements for WAGO Electrical Interconnection Products

WAGO Electrical Interconnection Products are designed for worldwide applications.

To properly commission products, the following environmental requirements must be observed during storage, transportation and operation.

Table 1: General Environmental Requirements for Storage, Transportation and Operation\*

Environmental requirements during	Value range
Operation	-35 °C ... +60 °C
Storage and transportation	-40 °C ... +60 °C
Relative humidity (storage and transportation)	20 % ... 95 % (non-condensing, no dew)

\*These requirements apply to open and packaged products unless otherwise specified on the product at [www.wago.com](http://www.wago.com) or on the catalog page.

**Polyamide (PA 66)**

WAGO uses modified, halogen-free, flame-retardant polyamides.

These materials do not corrode, are difficult to ignite and feature self-extinguishing properties (V0 rating per UL 94).

Adhering to UL 746C, the polyamides used at WAGO have a continuous operating temperature of 105°C (221°F) based on the relative temperature index with impact load (RTIimp). This ensures that the necessary electrical and mechanical insulating properties are maintained at a sufficiently guaranteed level over a long period of time.

The short-term upper temperature limit is 200°C (392°F).

In lower temperature ranges, it has been determined that no damage to the insulation material occurs during usage down to -35°C (-31°F). After installation and wiring, WAGO products can even be used at temperatures down to -60°C (-76°F).

Environmental humidity (up to 2.5% in a standard atmosphere) is absorbed, providing the polyamides with optimum elasticity, strength and durability.

In practical use, basic stabilization of WAGO's polyamides has been proven over many years to be sufficient to prevent damage caused by ozone or UV radiation exposure in intended applications.

Polyamides have excellent resilience against the most demanding climates and have proven themselves in tropical applications worldwide. Insulation parts made of polyamide are resistant to insects. The material does not provide oxygen or other biogenic elements to microorganisms.

The presence of anaerobic earth bacteria, mold, fungus and enzymes does not degrade the material.

Polyamides are resistant to most fuels, greases, and oils, as well as the most commonly used cleaners, such as alcohol, Freon, Frigen, and carbon tetrachloride. Acid resistance depends on the acid type and concentration, as well as the exposure time.

The use of insulation materials during in-house production at WAGO only occurs after acceptance of factory test certificates and specified material tests.

**Glass Fiber-Reinforced Polyamide (PA 66 GF)**

WAGO uses glass-fiber-reinforced polyamides for components with increased mechanical demands, such as levers, push-buttons or housings exposed to high stress, because they have significantly better mechanical characteristic properties than non-reinforced polyamides.

In general, materials are used that have excellent tracking resistance, flammability ratings and high temperature resistance.

More data can be found in the table.

**Polyphthalamide (PPA GF)**

Glass-fiber-reinforced, high-performance polyamides are ideal for high-temperature applications, due to the material's high level of thermal dimensional stability, its low dependence on ambient conditions and its excellent strength properties. The material's outstanding tracking resistance permits short creepage distances to be incorporated into miniature components. Fire protection equipment enables classification in flammability class V0 per UL 94 – even for extremely thin walls. PPA GF absorbs minute amounts of moisture from the atmosphere making it ideal for reflow soldering applications and for thin-walled, dimensionally stable components.

More data can be found in the table.

**Polyamide (PA 46)**

In comparison with PA 66, PA 46 has substantially higher dimensional stability under heat. The relative temperature index with impact load (RTIimp) is 115°C (239°F) for PA 4.6. The permissible short-term temperature for the type used by WAGO is 280°C (536°F).

More data can be found in the table.

**Polycarbonate (PC)**

Polycarbonate has excellent dimensional stability under heat. The electrical and mechanical properties remain intact at extremely high temperatures up to approximately 120°C (248°F) per UL Yellow Card. Its excellent electrical insulating properties and dimensional stability are virtually independent of environmental conditions, such as humidity and temperature. Highly precise components can be created due to the low shrinkage of the material during injection molding. Polycarbonate has excellent weather resistance and is also highly resistant to high energy radiation.

If the PC is not colored, then the components are glass-clear.

Thanks to its desirable properties (e.g., dimensional stability, heat resistance, non-flammability, durability and transparency), PC is a proven and widely used material in the electrical industry.

Depending on the demands placed on the finished product, WAGO uses polycarbonates that carry flammability classifications V2 and V0 per UL 94.

Medium-viscosity PC is used that features excellent chemical resistance.

## Material Specifications

### Contact Materials

Hard and extra-hard electrolytic copper (ECu), as well as extra-hard copper alloys are the standard materials used for the current-carrying parts of all WAGO products.

These materials combine excellent conductivity and good chemical resistance without the risk of stress-induced cracking.

### Contact Materials

The special tin layer, which is the standard layer for all current-carrying parts in WAGO products, ensures perfect long-term protection against corrosive substances. Furthermore, these layers provide a gas-tight contact that ensures a durable transition resistance.

At the clamping unit, the conductor is embedded into the soft tin layer via high contact pressure. This protects the contact area against corrosion.

The thick tin layer also ensures good solderability of both PCB terminal block and connector solder pins.

### Clamping Spring Material

Every WAGO clamping spring is made of high-quality, accurately tested austenitic chrome nickel steel (CrNi) with high tensile strength, which boasts proven corrosion resistance through long-term usage.

It is resistant to sea spray, city pollutants and industrial emissions (e.g., sulfur dioxide, hydrogen sulfide).

At room temperatures of approximately 20°C (68°F), the material is resistant to salt solutions up to 30% and dilute phosphoric acids up to 30%.

Even after decades of use, no galvanic corrosion between the chrome nickel spring steel (in connection with the contact materials used by WAGO) and the connected copper conductors has been detected.

The relaxation of the material as a function of time and surrounding temperatures up to 105°C (221°F) can be ignored. Samples loaded with 500 N/mm<sup>2</sup> at a temperature of 250°C (482°F) showed a relaxation of only 1.5%.

In certain product lines, the clamping springs are thermally treated at temperatures between 350°C (662°F) and 420°C (788°F) after production.

This treatment reduces internal stress due to the material's mechanical deformation, which may result in a slight brown discoloration of the spring surface.

WAGO only accepts deliveries of chrome nickel spring steel against certificates of conformity and after select material tests have been performed.

## General Technical Information on Electrical Equipment Used in Hazardous Areas

The formation of an explosive atmosphere is required for the existence of a potentially explosive hazard. Such an atmosphere can be produced at any location where flammable gases or liquids are manufactured, processed, transported and/or stored.

Such hazardous areas can be found in a wide range of industries, including chemical plants, refineries, power plants, paint production facilities, painting shops, filling stations, vehicles, sewage treatment plants, airports, grain mills or harbor facilities.

### THE FOLLOWING APPLIES AS A GUIDELINE FOR THE UNDERLYING PRINCIPLE FOR EXPLOSION PROTECTION:

#### General Requirements

The European EN 60079-0 Standard – VDE 0170-1 Classification – contains general requirements for the design and testing of electrical equipment to be used in hazardous areas.

This ensures this equipment does not cause an explosion in the surrounding atmosphere. EN 60079-0 is supplemented or revised by the European standards indicated on the right which refer to the specifically standardized types of protection.

#### Electrical Equipment

Electrical equipment includes all items used in whole or in part with electricity. This includes items for generation, transport, distribution, storage, measurement, control, conversion and consumption of electrical power, as well as telecommunications.

#### Ex Components

Ex components are elements of electrical equipment for hazardous areas that are marked with the "U" letter. These components must not be used on their own in such areas and require an additional certificate when used in such areas when installed in the electrical equipment.

#### Ignition Protection Categories

Only explosion-proof (protected) equipment must be used in areas in which an explosive atmosphere may still be expected despite the implementation of prevention measures. Explosion-protected electrical equipment can have various types of protection in accordance with the EN 60079 standard requirements.

Protection used by the manufacturer essentially depends on the type and function of the apparatus. From a safety point of view, all standardized types of protection should be viewed as equal.

The ignition protection category "n" exclusively describes the use of explosion-protected electrical components in Zone 2. This zone includes areas in which hazardous, potentially explosive atmospheres are likely to occur rarely or short-term. This represents a transition between Zone 1, in which explosion protection is required, and the safe area in which, for example, welding may be performed at any time.

Regulations covering these electrical components are being prepared worldwide. Organizations such as KEMA in the Netherlands, or PTB in Germany certify that the devices meet the requirements of the EN 60079-15 standard.

Ignition protection category "n" also requires that electrical equipment be provided with additional ID markings as follows:

- nA – non-sparking
- nC – enclosed-break, hermetically sealed, non-incendive, sealed
- nR – restricted-breathing

The table on the opposite page shows an overview of the standardized ignition protection categories and describes their basic principle, as well as typical applications.

## General Technical Information on Electrical Equipment Used in Hazardous Areas Continued

Ignition Protection Categories			
Symbol	Standard	Explanation	Application Area
"o"	IEC 60079-6 EN 60079-6	<b>Equipment protection by oil immersion:</b> Electrical equipment or parts of such equipment are immersed in oil.	Zones 1 + 2
"p"	IEC 60079-2 EN 60079-2	<b>Equipment protection by pressurized enclosure:</b> The ingress of the external (explosive) atmosphere into the electrical equipment housing is prevented by maintaining a protective gas internally at a pressure above that of the external atmosphere.	Zones 1 + 2
"q"	IEC 60079-5 EN 60079-5	<b>Equipment protection by sand filling:</b> Filling the electrical equipment housing with fine grain sand prevents the ignition of a surrounding explosive atmosphere by an electric arc generated in the housing.	Zones 1 + 2
"d"	IEC 60079-1 EN 60079-1	<b>Equipment protection by flameproof enclosures:</b> The parts that could ignite an explosive atmosphere are encapsulated in a housing, which will withstand the explosion pressure within the housing.	Zones 1 + 2
"eb" "ec"	IEC 60079-7 EN 60079-7	<b>Equipment protection by increased safety:</b> Additional measures applied to achieve increased security against the possibility of excessive temperatures and the occurrence of arcs or sparks.	Zones 1 + 2
"i"	IEC 60079-11 EN 60079-11	<b>Equipment protection by intrinsic safety:</b> Power circuit in which no sparks or thermal effects can occur and cause the ignition of a certain explosive atmosphere.	Zones 1 + 2 following special testing Zone 0
"nA" "nC" "nR"	IEC 60079-15 EN 60079-15	<b>Equipment protection by type of protection "n":</b> Electrical equipment of group II for use in areas in which an explosive mixture of gas, vapor or mist is unlikely to occur during normal operation and, if it does, will be for a short period.	Zone 2:
"m"	IEC 60079-18 EN 60079-18	<b>Equipment protection by cast encapsulation:</b> Dangerous electrical equipment is embedded in a cast mass. This corresponds approximately to the known special Ex s protection type.	Zones 1 + 2
	IEC 60079-25 EN 60079-25	<b>Intrinsically safe electrical systems "i":</b> Assembly of interconnected electrical equipment in which the circuits intended for use, as a whole or in part, in hazardous environments are intrinsically safe. It is documented accordingly in the system description	Zones 1 + 2 following special testing Zone 0

**Hazardous Areas**

Hazardous areas are zones in which the atmosphere may become explosive. An explosive atmosphere is a mixture of flammable substances in the form of gases, vapors or mixtures with air under atmospheric conditions in critically mixed ratios such that excessive high temperature, arcs or sparks may cause an explosion.

EN 60079-10-1/EN 60079-10-2 and all other well-known standards rank hazardous areas according to the likelihood of the occurrence of an explosive atmosphere into the following zones:

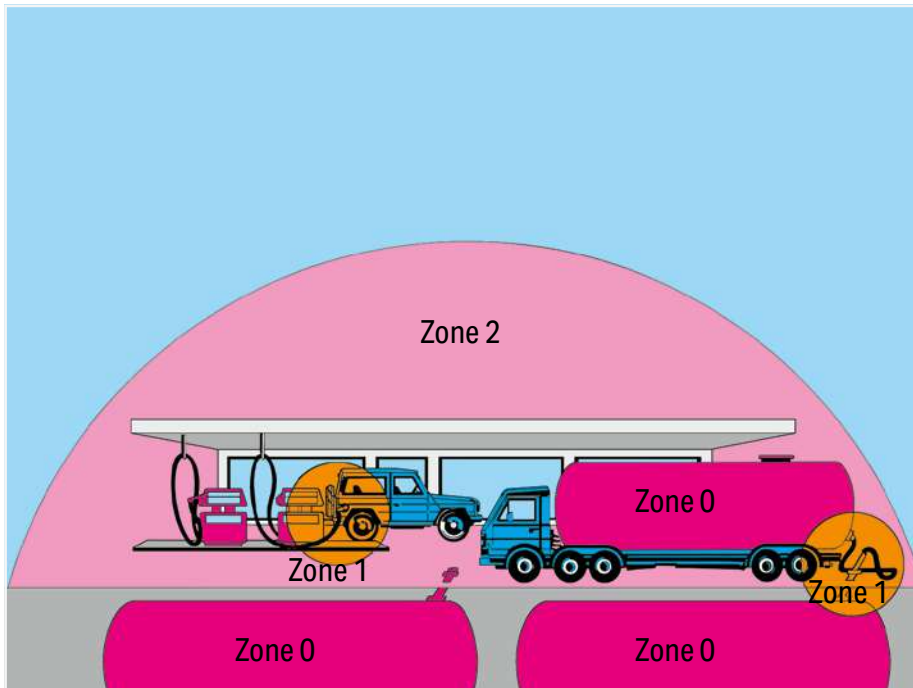

Hazardous areas due to explosive gases, vapors and mists:

**Zone 0**

Area in which an explosive gas atmosphere is present continuously, for long periods or frequently.

**Zone 1**

Area in which an explosive gas atmosphere is likely to occur periodically or occasionally during normal operation.

**Zone 2:**

Area in which an explosive gas atmosphere is unlikely to occur during normal operation; if it does occur, then it is temporarily.

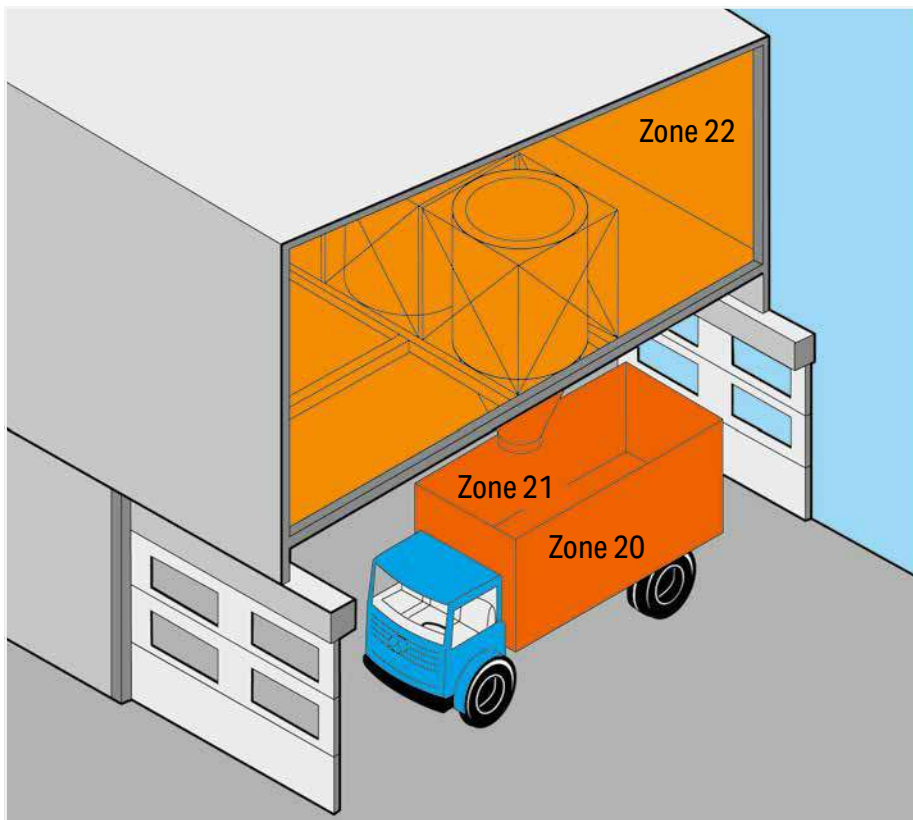

Hazardous areas due to explosive dust/air mixtures:

**Zone 20**

Area in which an explosive dust atmosphere due to dust/air mixtures is present continuously, for long periods or frequently.

**Zone 21**

Area in which an explosive dust atmosphere due to dust/air mixtures is likely to occur occasionally during normal operation.

**Zone 22**

Area in which an explosive dust atmosphere due to flammable dust/air mixtures is unlikely to occur during normal operation; but if it occurs, then only for a short period of time.

## General Technical Information on Electrical Equipment Used in Hazardous Areas

### Continued

EN 60079-0 also classifies electrical equipment for use in hazardous areas into two groups:

#### Group I:

Electrical equipment for mines susceptible to firedamp

#### Group II:

Electrical equipment for hazardous areas, except for mines susceptible to firedamp.

As this broad application range encompasses a large number of potentially flammable gases, Group II is broken down into sub-groups IIA, IIB and IIC.

This breakdown is based on different gases/materials exhibiting differing ignition power levels as parameters. Therefore, representative gases have been allocated to these three sub-groups:

- IIA – Propane
- IIB – Ethylene
- IIC – Hydrogen

WAGO's terminal blocks can be used both in Group I and Group II.

This information is given under Item 12 in the EU Prototype Test Certificates, based on which the terminal blocks have been approved for Group I and Group II.

Temperature Class	Maximum Surface Temperature (°C)
T1	450
T2	300
T3	200
T4	135
T5	100
T6	85

Depending on the maximum surface temperature, electrical equipment in Group II are classified in temperature categories T1 to T6 for all protection types. The surrounding air temperature, which must be accounted for in dimensioning, is defined as 40°C/104°F (deviations are acceptable under some conditions).

Terminal blocks for "e" (increased safety) protection type are generally assigned to temperature category T 6. When rail-mount terminal blocks are used in equipment of temperature categories T1 to T5, ensure that the highest temperature on the insulating parts does not exceed 85°C (185°F). The highest measured surface temperature rise must not exceed 40 K.

Thermal resistance of the insulation material must be at least 20°C (68°F) greater than the highest operating temperature. Low temperature stability is considered to be sufficient when the insulation material can withstand 24-hour storage at a temperature of –60°C (–76°F) without nullifying the type of protection.

#### Special Requirements "Increased Safety Ex e"

The European EN 60079-7 Standard – VDE 0170-6 Classification – or the EN IEC 60079-7 Standard in the UK contain special requirements for the design and testing of electrical equipment with "e" (increased safety) protection type for hazardous areas.

This standard is a supplement to EN 60079-0 or EN IEC 60079-0 and applies to equipment or parts thereof that neither generate sparks or arcing under normal operating conditions, nor exhibit hazardous temperatures.

This standard describes special measures, which have to be observed to obtain a safety degree according to the "e" (increased safety) protection type.

Ex components such as rail-mount terminal blocks are covered by Section 4.2 "Terminal Blocks for External Conductors":

- The connectors must be installed in an enclosure meeting the requirements of a recognized protection type per EN 60079-0 and EN IEC 60079-0, Section 1 or EN 60079-31.
- When installing the terminal blocks in an enclosure of protection type "e" (increased safety) per EN 60079-7 or the EN IEC 60079-7 Standard in the UK, the clearances and creepage distances of Table 2 must be observed. When using accessories, the installation instructions of the manufacturer must be observed.
- The connectors meet the requirements of the Group I Category M2 (I M 2) components.
- Please also observe the "Schedule of Limitations" in the individual certificates.
- The use of this component requires a new assessment by a notified certification agency.
- Please also observe the "Schedule of Limitations" in the individual certificates.

#### Minimum Ignition Power of Typical Gases:

Explosion Group	I	IIA	IIB	IIC
Gas	Methane	Propane	Ethylene	Hydrogen
Ignition Power	280	250	82	16

The following are the most important design requirements for terminal blocks for external supply conductors to electrical equipment: These must:

- be sufficiently large to permit reliable connection of external supply conductors with cross section of at least the size required by the nominal current of the equipment
- be protected against self-loosening and designed such that the supply conductors cannot slip out of their clamping units
- be designed such that adequate contact pressure is ensured without damaging the conductors
- be designed such that their contact pres-

sure does not change with temperature cycling

- be equipped with a spring connecting link for the connection of stranded conductors
- be designed so as to allow secure connection of smaller conductors for terminal blocks up to 4 mm<sup>2</sup> (12 AWG).

Classification of insulation materials according to their tracking resistance is based on their Comparative Tracking Index (CTI) and is defined in Table 1 as follows:

This classification applies to insulating parts without ribs or grooves.

If the insulating parts have ribs or grooves sufficiently large to be considered, the minimum creepage distances must be set according to values for the insulation materials in the next-higher level (e.g., Group I, instead of Group II).

Accounting for the surrounding air temperature of 40°C (104°F) specified for electrical equipment, the current-carrying capacity of rubber-insulated conductors is reduced to 82%, based on DIN VDE 0298-4:2013-06, Table 12 and to 87% for PVC-insulated conductors for the current-carrying capacity defined for 30°C (86°F) in accordance with DIN VDE 0298-4:2013-06, Item 4.3.3.

**Conductor Types and Conductor Preparation**

In accordance with EN 60079-14/DIN VDE 0165-1, the ends of stranded and fine-stranded conductors must be protected against splaying (e.g., via cable lugs or ferrules) or by the type of terminal blocks used. Soldering alone is not sufficient.

According to EN 60069-7/DIN VDE 0170-6, connecting electrical equipment to terminal blocks having an "e" (increased safety) protection type must not lead to a reduction of the clearances and creepage distances.

Based on experience through the application of terminal blocks in aggressive atmospheres in the chemical industry, WAGO recommends gas-tight tinned copper ferrules or tinned copper pin terminals when connecting fine-stranded conductors to terminal blocks

**Table 1– Tracking Resistance for Insulation Materials**

Material Group	Comparative Tracking Index
I	600 ≤ CTI
II	400 ≤ CTI < 600
III a	175 ≤ CTI < 400
III b	100 ≤ CTI < 175

in corrosive atmospheres.

**Table 2– Minimum Creepage Distances/Clearances and Isolations**

Voltage (see <sup>a</sup> and <sup>b</sup> ) RMS Value for AC or DC Voltage V	Minimum Creepage Distance mm								Minimum Clearance and Isolations mm		
	Material Group								Clearance mm	Distance under Coating <sup>c</sup>	
	I		II		III a		III b				
	"eb"	"ec"	"eb"	"ec"	"eb"	"ec"	"eb"	"ec"	"eb"	"ec"	"ec"
≤ 10 (see <sup>c</sup> )	1.6	1	1.6	1	1.6	1	-	1	1.6	0.4	0.3
≤ 12.5	1.6	1.05	1.6	1.05	1.6	1.05	-	1.05	1.6	0.4	0.3
≤ 16	1.6	1.1	1.6	1.1	1.6	1.1	-	1.1	1.6	0.8	0.3
≤ 20	1.6	1.2	1.6	1.2	1.6	1.2	-	1.2	1.6	0.8	0.3
≤ 25	1.7	1.25	1.7	1.25	1.7	1.25	-	1.25	1.7	0.8	0.3
≤ 32	1.8	1.3	1.8	1.3	1.8	1.3	-	1.3	1.8	0.8	0.3
≤ 40	1.9	1.4	2.4	1.6	3	1.8	-	1.8	1.9	0.8	0.6
≤ 50	2.1	1.5	2.6	1.7	3.4	1.9	-	1.9	2.1	0.8	0.6
≤ 63	2.1	1.6	2.6	1.8	3.4	2	-	2	2.1	0.8	0.6
≤ 80	2.2	1.7	2.8	1.9	3.6	2.1	-	2.1	2.2	0.8	0.8
≤ 100	2.4	1.8	3	2	3.8	2.2	-	2.2	2.4	0.8	0.8
≤ 125	2.5	1.9	3.2	2.1	4	2.4	-	2.4	2.5	1	0.8
≤ 160	3.2	2	4	2.2	5	2.5	-	2.5	3.2	1.5	1.1
≤ 200	4	2.5	5	2.8	6.3	3.2	-	3.2	4	2	1.7
≤ 250	5	3.2	6.3	3.6	8	4	-	4	5	2.5	1.7
≤ 320	6.3	4	8	4.5	10	5	-	5	6	3	2.4
≤ 400	8	5	10	5.6	12.5	6.3	-	6.3	6	4	2.4
≤ 500	10	6.3	12.5	7.1	16	8	-	8	8	5	2.4
≤ 630	12	8	16	9	20	10	-	10	10	5.5	2.9
≤ 800	16	10	20	11	25	12.5	-	-	12	7	4
≤ 1000	20	11	25	11	32	13	-	-	14	8	5.8
≤ 1250	22	12	26	12	32	15	-	-	18	10	-
≤ 1600	23	13	27	13	32	17	-	-	20	12	-
≤ 2000	25	14	28	14	32	20	-	-	23	14	-
≤ 2500	32	18	36	18	40	25	-	-	29	18	-
≤ 3200	40	22	45	22	50	32	-	-	36	22	-
≤ 4000	50	28	56	28	63	40	-	-	44	28	-
≤ 5000	63	36	71	36	80	50	-	-	50	36	-
≤ 6300	80	45	90	45	100	63	-	-	60	45	-
≤ 8000	100	56	110	56	125	80	-	-	80	56	-
≤ 10000	125	71	140	71	160	100	-	-	100	70	-
≤ 12500	-	90	-	90	-	125	-	-	-	89	-
≤ 13640	-	98	-	98	-	138	-	-	-	97	-

<sup>a</sup> When determining the required values for creepage distances and clearances, the working voltage may be 1.1 times higher than the value in the table.  
NOTE: The factor of 1.1 takes into account that in many places in a circuit the working voltage is equal to the rated voltage and that a number of rated voltages are used, which are covered by a factor of 1.1.

<sup>b</sup> The specified values for creepage distances and clearances already take into account a 10% tolerance for the highest supply voltage. Therefore, further considerations on the voltage fluctuations are unnecessary for determining which voltage value from the table should be used.

<sup>c</sup> CTI values are not applicable for voltages of 10 V or less. Materials that do not meet the requirements of material group III a can be used.

<sup>d</sup> The specified distances under consideration apply to printed circuit boards in protection level "ec" after 4.5.

It is expressly prohibited to use insulating parts for transferring contact forces. Terminal blocks with sharp edges which could damage supply lines and those types that can be rotated, turned or permanently deformed when fixed in place are not permitted for use. Terminal blocks for internal connections in electrical equipment must not be subjected to excessive mechanical stress. These items must fulfill the requirements for terminal blocks used for external supply conductors.

Clearances between conductive parts having different potentials must be at least 3 mm for external connections, as specified in Table 2.

The value of the creepage distances depends on the working voltage, surface geometry of the insulating parts and tracking resistance of the insulation material.

Grooves on the surface may only be considered if they are at least 2.5 mm deep and wide; ribs on the surface only if their height is at least 2.5 mm and their width corresponds to the mechanical strength of the material, however not smaller than 1 mm.

# General Technical Information on Electrical Equipment Used in Hazardous Areas Continued

## Approvals

Terminal blocks may be used in Zones 1 and 2, provided that the terminal blocks are accommodated in an enclosure that has a minimum IP54 protection and an Ex e certification.

Terminal blocks are considered to be Ex components because they are a part of the equipment. Part certificates provided by Ex Certification Agencies serve as a basis for issuing the complete conformity declaration for the unit.

An EC-type examination certificate is issued in accordance with the 2014/34/EU ATEX Directive.

In addition, an IEXEx Certificate may also be obtained from an appropriate, recognized certification agency in accordance with the IECEx Certification Agreement that is accepted throughout Europe and also in countries such as Canada, China and Australia. These certificates can also be viewed at: [www.iecex.com](http://www.iecex.com).

## Terminal block marking per 2014/34/EU ATEX Directive:

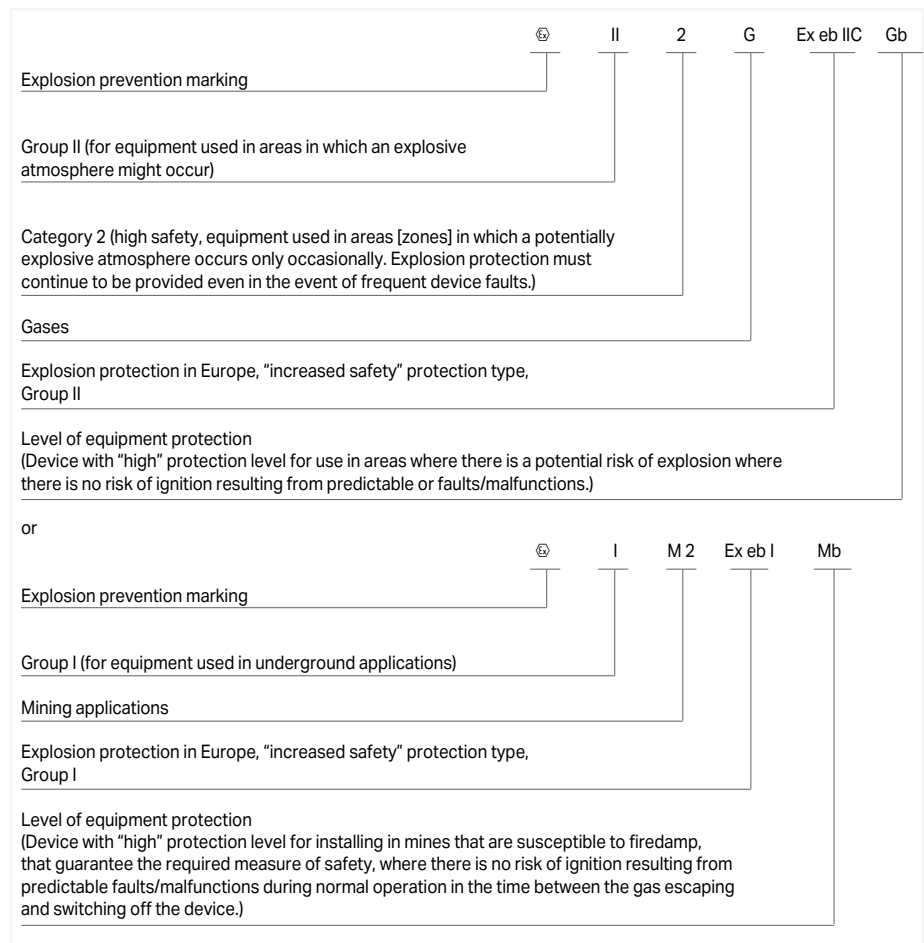

## Example of marking (rear):

### Series

### Manufacturer's name

### Nominal isolation voltage

### Protection type

### Part certification no.

### Nominal cross section

(solid, stranded or fine-stranded conductors)

The embossed details on the terminal blocks show the manufacturer's name, the series number, the approval number, the approval data and the name of the testing authority. The type of protection Ex eb IIC Gb shown on the label or on the smallest packaging unit.

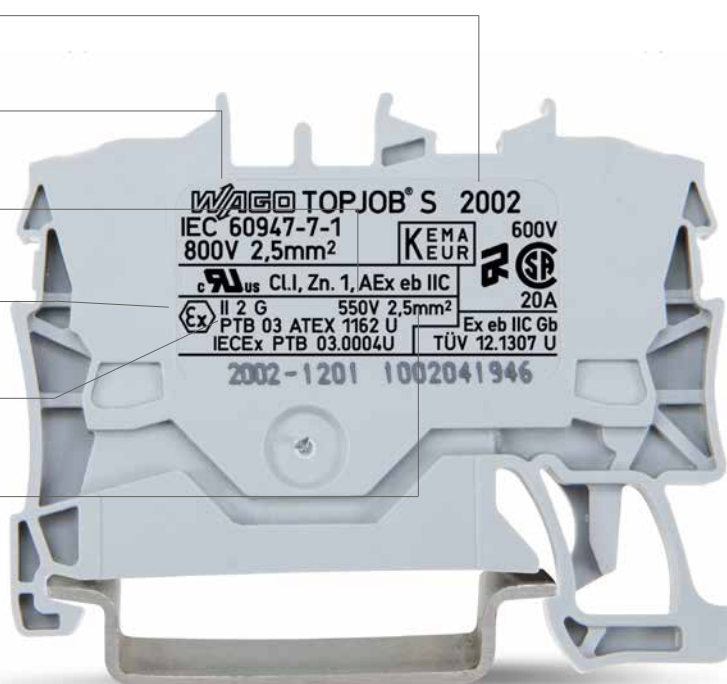

6

Terminal blocks for Class I, Zone 1, Ex eb IIC hazardous locations can be approved for Ex applications per UL 60079-7 standard. As a result of international harmonization efforts, the UL certificate can be issued on the basis of EN 60079-0 or EN 60079-7 standards, provided that the terminal blocks have also been approved per UL 1059 (ordinary location).

If desired by the applicant, terminal blocks can simultaneously be approved in accordance with the Canadian Standards CAN/CSA-C22.2 No. 60079-0 and CAN/CSA C22.2 No. 60079-7 and released for use in Canada. The terminal blocks are marked with  Cl. I, Zn. 1, AEx eb IIC.

EU-type examination certificates have been granted to all WAGO terminal blocks listed in this catalog. WAGO terminal blocks approved for use in Ex eb IIC areas are manufactured of flame-resistant, self-extinguishing Polyamide 66. The same applies to the terminal blocks used in non-hazardous areas. Tracking resistance with a CTI value of 600 as per IEC 60112 and a constant operating temperature of 105°C (22°F) in accordance with IEC 60216-1 and -2 are provided. Factory part quality tests are performed on all CAGE CLAMP® rail-mount terminal blocks with Ex eb IIC approval to monitor and ensure the quality features described above.



**IECEx Certificate of Conformity**

INTERNATIONAL ELECTROTECHNICAL COMMISSION  
IEC Certification Scheme for Explosive Atmospheres  
for rules and details of the IECEx Scheme, visit www.iecex.com

**Ex COMPONENT CERTIFICATE**

Certificate No.:	IECEx PTB 18.0012U	Issue No. 0	Certificate history: Issue No. 0 (2018-08-30)
Status:	Current	Page 1 of 3	
Date of Issue:	2018-08-30		
Applicant:	WAGO Kontakttechnik GmbH & Co. KG Hansastraße 27 32423 Minden Germany		
Ex Component:	WAGO type PE & Through terminal blocks type TOPJOB S 2202-**** and TOPJOB S 2202-****		

This component is NOT intended to be used alone and requires additional consideration when incorporated into other equipment or systems for use in explosive atmospheres (refer to IEC 60079-0).

Type of Protection: **Increased Safety "ib"**  
Marking: Ex eb IIC Gb and Ex eb I Mb

Approved for issue on behalf of the IECEx Certification Body:   
Position: Department "Explosion Protection in Energy Technology"

Signature:   
(for printed version)  
Date: 

1. This certificate and schedule may only be reproduced in full.  
2. This certificate is not transferable and remains the property of the issuing body.  
3. The Status and authenticity of this certificate may be verified by visiting the [Official IECEx Website](http://Official IECEx Website).

Certificate issued by:  
Physikalisch-Technische Bundesanstalt (PTB)  
Bundesallee 100  
38116 Braunschweig  
Germany



**PTB** Physikalisch-Technische Bundesanstalt  
Braunschweig und Berlin  
Nationales Metrologieinstitut





**EU-Baumusterprüfbescheinigung**

(1) Komponente zur bestimmungsgemäßen Verwendung in explosionsgefährdeten Bereichen  
**Richtlinie 2014/34/EU**

(2) EU-Baumusterprüfbescheinigungsnummer  
**PTB 18 ATEX 1005 U** **Ausgabe: 0**

(3) Produkt:  
Durchgangsreihenklemmen Typ TOPJOB S 2202-\*\*\*\*  
Schutzleiterreihenklemmen Typ TOPJOB S 2202-\*\*\*\*

(4) Hersteller:  
WAGO Kontakttechnik GmbH & Co. KG

(5) Anschrift:  
Hansastraße 27, 32423 Minden, Deutschland

(6) Die Bauart dieses Produkts sowie die verschiedenen zulässigen Ausführungen sind in der Anlage und den darin aufgeführten Unterlagen zu dieser Baumusterprüfbescheinigung festgelegt.

(7) Die Physikalisch-Technische Bundesanstalt, notifizierte Stelle Nr. 0102 gemäß Artikel 17 der Richtlinie 2014/34/EU des Europäischen Parlaments und des Rates vom 26. Februar 2014, bescheinigt, dass dieses Produkt die grundlegenden Sicherheits- und Gesundheitsanforderungen für die Konzeption und den Bau von Produkten zur bestimmungsgemäßen Verwendung in explosionsgefährdeten Bereichen gemäß Anhang II der Richtlinie erfüllt.

Die Ergebnisse der Prüfung sind in dem vertraulichen Prüfbericht PTB Ex 18-17171 festgehalten.

(8) Die grundlegenden Sicherheits- und Gesundheitsanforderungen werden erfüllt durch Übereinstimmung mit **IEC 60079-0:2017, EN 60079-7:2015**

(9) Das Zeichen "U" hinter der Zertifikatsnummer gibt an, dass dieses Zertifikat nicht mit einem für ein Gerät oder Schutzsystem vorgesehenen Zertifikat verwechselt werden darf. Diese Komponenten-Bescheinigung darf als Basis für die Bescheinigung eines Gerätes oder Schutzsystems verwendet werden.

(10) Diese EU-Baumusterprüfbescheinigung bezieht sich nur auf Konzeption und Prüfung des festgelegten Produkts gemäß Richtlinie 2014/34/EU. Weitere Anforderungen dieser Richtlinie gelten für die Herstellung und das Bereitstellen auf dem Markt. Diese Anforderungen werden nicht durch diese Bescheinigung abgedeckt.

(11) Die Kennzeichnung des Produkts muss die folgenden Angaben enthalten:  
 **II 2 G Ex eb IIC Gb bzw. I M 2 Ex eb I Mb**

Konformitätsbewertungsstelle, Sektor Explosionsschutz Braunschweig, 30. August 2018  
Im Auftrag   
Dipl.-Phys. U. Völkel

Seite 1/3

EU-Baumusterprüfbescheinigungen ohne Unterschrift und ohne Siegel haben keine Gültigkeit.  
Diese EU-Baumusterprüfbescheinigung darf nur unverändert weitervertrieben werden.  
Ausgabe oder Änderungen bedürfen der Genehmigung der Physikalisch-Technischen Bundesanstalt.  
Physikalisch-Technische Bundesanstalt • Bundesallee 100 • 38116 Braunschweig • DEUTSCHLAND

## General Technical Information on Electrical Equipment Used in Hazardous Areas

### Continued

#### Special Requirements

**Equipment Protection by Intrinsic Safety "i"**  
The European EN 60079-11 Standard – Classification VDE 0170-7 – contains special requirements for the design and testing of electrical equipment with "i" (intrinsic safety) protection type for use in hazardous areas.

A circuit is "intrinsically safe" when, under normal operating conditions and in the event of specific fault conditions, no sparks or thermal effects can occur and cause the ignition of a certain explosive atmosphere.

A distinction is made here between:

- intrinsically safe electrical equipment when all circuits are intrinsically safe
- associated electrical equipment including both intrinsically and non-intrinsically safe circuits, and being designed such that the non-intrinsically safe circuits cannot affect the intrinsically safe ones.

Intrinsically safe electrical equipment and intrinsically safe parts of associated electrical equipment are classified at "ia", "ib" or "ic" protection level.

Electrical equipment classified Ex "ia" must not ignite when current is applied in the following cases:

- During fault-free operation, with those non-discreet faults present that result in the most adverse condition
- During fault-free operation and with a discreet fault, plus those non-discreet faults that result in unfavorable conditions
- During fault-free operation with two discreet faults, plus those non-discreet faults that result in the most adverse conditions.

Electrical equipment classified Ex "ib" must not ignite when current is applied in the following cases:

- During fault-free operation, with those non-discreet faults present that result in the most adverse condition
- During fault-free operation and with a discreet fault, plus those non-discreet faults that result in unfavorable conditions.

At applied voltages, the intrinsically safe circuits in electrical equipment of protection level "ic" shall not be capable of causing ignition during undisturbed operation and under the conditions specified in this standard. No special approval is required for terminal blocks used as simple electrical equipment for "Ex i" protection type, as they do not contain a voltage source and precise information is available concerning electrical data and temperature rise performance.

The terminal blocks must be identifiable, for example by their type designation, and the following design requirements must also be upheld:

Clearances and creepage distances between bare conductive parts of terminal blocks of separate intrinsically safe circuits and grounded or floating conductive parts shall be equal to or greater than the values given in Table 5 (see 672). If separate intrinsically safe circuits are to be considered, the air gap between bare conductive parts of the outer connection parts must meet the following requirements:

- at least 6 mm between the separate intrinsically safe circuits
- at least 3 mm from grounded parts, if a possible connection to ground has not been considered in the safety analysis. Each possible motion of metallic parts that are not rigidly secured must be considered.

**Terminal block marking must be unique and clearly visible. If a color is used for this, the color must be light blue (similar to RAL 5015).**

Note also when using terminal blocks:

Terminal blocks used for intrinsically safe circuits must be isolated from those used in non-intrinsically safe circuits. This is accomplished by several accepted methods. First, intrinsically safe circuits are separated by at least 50 mm of air space from non-intrinsically safe circuits.

Second, intrinsically safe circuits are housed in a separate enclosure. Third, intrinsically safe terminal blocks are separated from non-intrinsically safe terminal blocks by either an insulated partition or grounded metal partition. The partition size must allow for either 1.5 mm or less distance from the sides of the housing or provide at least 50 mm of creepage distance between the intrinsically and non-intrinsically safe circuits in all directions.

The insulation between an intrinsically safe and a non-intrinsically safe circuit has to withstand an effective AC voltage of 2 x nominal value (U) 1000 V or a minimum of 1500 kV, whereby U represents the total of the effective voltages of the intrinsically safe and the non-intrinsically safe circuit.

Short circuit between different intrinsically safe circuits could cause dangerous conditions. The insulation between these circuits should withstand an effective voltage of at least 500 VAC or 2 UAC where U is the total of the effective voltages of the related circuits.

In accordance with EN 60079-14/ DIN VDE 0165-1, in intrinsically safe circuits, the ends of stranded and fine-stranded conductors must be protected against splaying (e.g., via cable lugs or ferrules) or by the type of terminal blocks used. Soldering alone is not sufficient.

WAGO recommends gas-tight tinned copper ferrules or tinned copper pin terminals when connecting fine-stranded conductors to terminal blocks in corrosive atmospheres.

Requirements pertaining to the necessary distances as appropriate for use of the terminal blocks in the area DIN EN 60079-11 (VDE 0170-7) "Explosive atmosphere – Part 11: Device protection by intrinsically safe features "i" (IEC 60079-11)" are defined under Section 6.2 "Connecting point for external circuits," Section 6.2.1 "Terminal blocks." In general, the following can be stated for terminal blocks based on figure 1: "Example of isolated intrinsically safe terminal blocks with partition" in conjunction with figure 2: "Example of isolation of conductive parts," considering Table 5 – "Clearances, Creepage and Isolation Distances."

Outside:

a) Isolated intrinsically safe circuits: at least 6 mm

**All PCB terminal blocks listed on the ordering pages as suitable for Ex "i" applications fulfill these requirements.**

b) Intrinsically safe circuits and normal circuits (non-intrinsically safe):  $\geq 50$  mm

Inside:

a) Ex "i" to Ex "i"

b) Ex "i" to normal circuits

c) Ex "i" to ground

Based on Figure 2 and Table 5 (see next page) in accordance with the selected protection level and the special requirements for isolation distances as described in Sections 6.3.1 to 6.3.13, or in accordance with the alternative procedure for dimensioning of isolation distances given in Annex F.

Terminal blocks with smaller pin spacing may also be used for internal connections, provided they meet the requirements laid out in Table 5 (see below).

The exact clearances and creepage distances as well as separation distances based on Table 5 must be derived from the application items cited above.

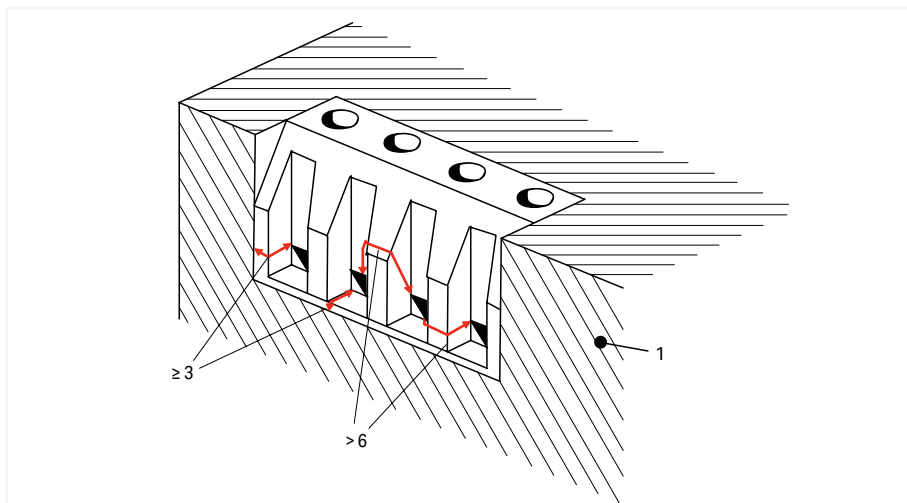
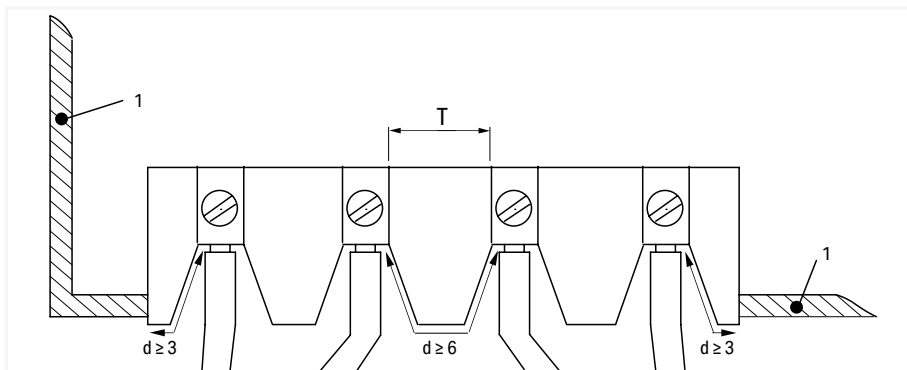

Legend:

- 1 Conductive cover
- T Distances based on Table 5
- d Distance at outer connecting parts of the terminal blocks according to 6.2.1

Note:

The dimensions indicated here represent the clearances and creepage distances around the insulation and not the thickness of the insulation.

Dimensions in mm

Figure 1a: Requirements for clearances and creepage distances for terminal blocks with isolated, intrinsically safe circuits

# General Technical Information on Electrical Equipment Used in Hazardous Areas Continued

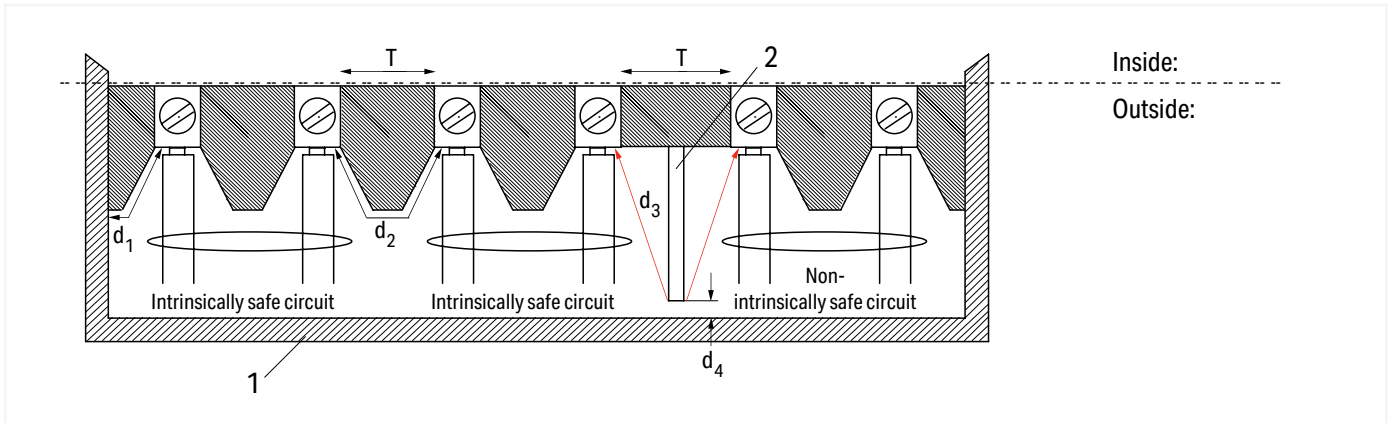

Figure 1b: Example of isolated intrinsically safe and non-intrinsically safe terminal blocks by a partition

**Legend:**

- 1 Cover: non-conductive or conductive and grounded
- 2 Partition based on 6.2.1 b); in this example, the partition must end at the base
- T Distances based on Table 5
- d1 ≥ 3 mm, when the cover is conductive and grounded
- d2 ≥ 6 mm
- d3 ≥ 50 mm or d4 ≤ 1.5 mm

**Note:**

The dimensions indicated here represent the clearances around the insulation and not the thickness of the insulation.

**Table 5 – Clearances, Creepage and Isolation Distances**

1 Voltage (Peak) (V)	2 Clearance (in mm)		3 Separation by Encapsulation (in mm)		4 Separation by Fixed Insulation (in mm)		5 Creepage Distance through Air (in mm)		6 Creepage Distance be- neath Protective Layer (in mm)		7 Comparative Tracking In- dex (CTI)	
	ia, ib	ic	ia, ib	ic	ia, ib	ic	ia, ib	ic	ia, ib	ic	ia	ib, ic
10	1.5	0.4	0.5	0.2	0.5	0.2	1.5	1.0	0.5	0.3	--	
30	2.0	0.8	0.7	0.2	0.5	0.2	2.0	1.3	0.7	0.3	100	100
60	3.0	0.8	1.0	0.3	0.5	0.3	3.0	1.9	1.0	0.6	100	100
90	4.0	0.8	1.3	0.3	0.7	0.3	4.0	2.1	1.3	0.6	100	100
190	5.0	1.5	1.7	0.6	0.8	0.6	8.0	2.5	2.6	1.1	175	175
375	6.0	2.5	2.0	0.6	1.0	0.6	10.0	4.0	3.3	1.7	175	175
550	7.0	4.0	2.4	0.8	1.2	0.8	15.0	6.3	5.0	2.4	275	175
750	8.0	5.0	2.7	0.9	1.4	0.9	18.0	10.0	6.0	2.9	275	175
1000	10.0	7.0	3.3	1.1	1.7	1.1	25.0	12.5	8.3	4.0	275	175
1300	14.0	8.0	4.6	1.7	2.3	1.7	36.0	13.0	12.0	5.8	275	175
1575	16.0	10.0	5.3	*	2.7	*	49.0	15.0	16.3	*	275	175
3.3k	*	18.0	9.0	*	4.5	*	*	32.0	*	*	*	*
4.7k	*	22.0	12.0	*	6.0	*	*	50.0	*	*	*	*
9.5k	*	45.0	20.0	*	10.0	*	*	100.0	*	*	*	*
15.6k	*	70.0	33.0	*	16.5	*	*	150.0	*	*	*	*

Note 1: \*At present, no values have been recommended for these voltages.

Note 2: Proof of fulfillment of the CTI requirements for the insulating materials must be provided by the manufacturer. Defining a CTI is not required for insulation materials for voltage levels up to 10 V.

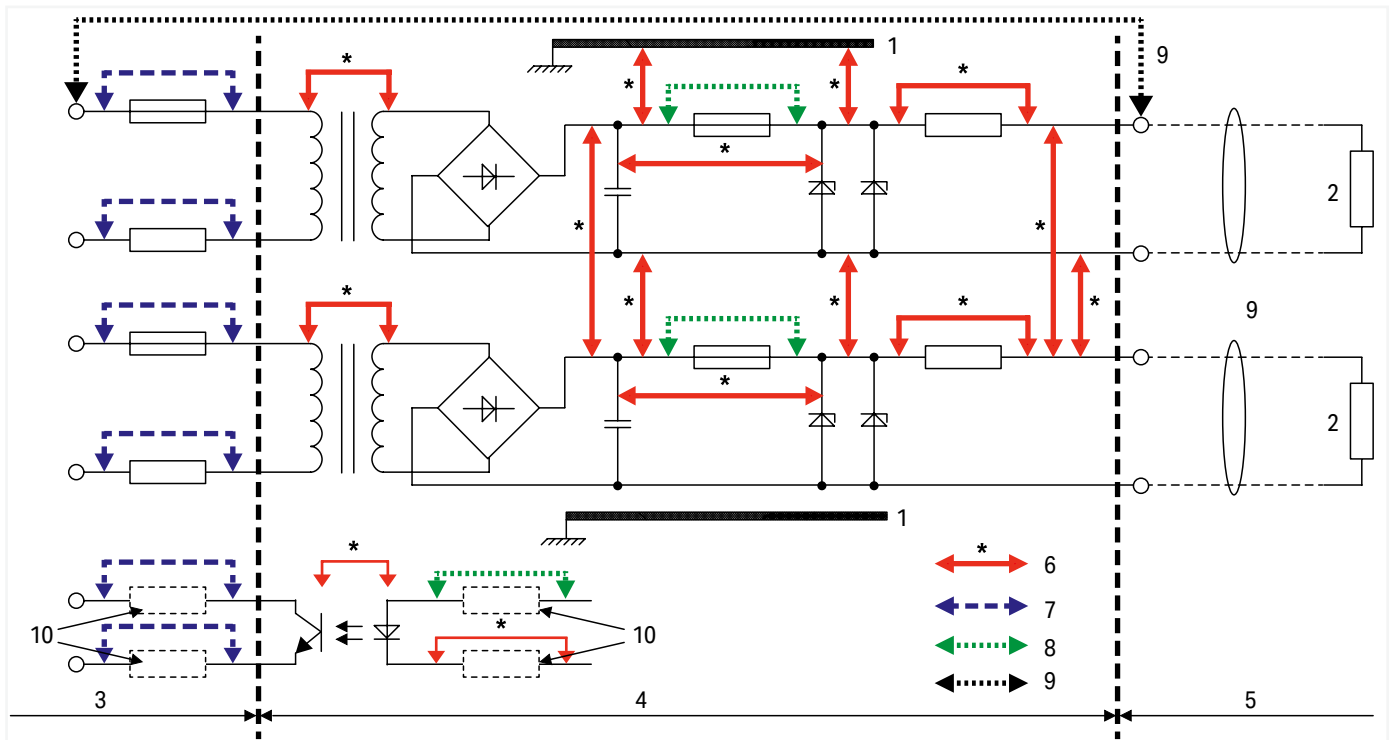

Figure 2: Isolation examples for conductive parts

**Legend:**

- 1 Chassis
- 2 Load
- 3 Non-intrinsically safe circuit defined by  $U_m$
- 4 Portion of intrinsically safe circuit, item is not intrinsically safe
- 5 Intrinsically safe circuit
- 6 Dimensions for which Table 5 applies
- 7 Dimensions for which general industrial standards apply
- 8 Dimensions per 7.3
- 9 Dimensions based on 6.2.1 for output terminal blocks between isolated intrinsically safe circuits ( $d_2 \geq 6 \text{ mm}$ ) and between intrinsically safe circuits and non-intrinsically safe circuits ( $d_3 \geq 50 \text{ mm}$ )
- 10 Where required

In accordance with DIN EN 60079-14 (VDE 0165-1), in intrinsically safe circuits, the ends of stranded and fine-stranded conductors must be protected against splaying (e.g., via cable lugs or ferrules) or by the type of terminal blocks used. Soldering alone is not sufficient.

The conductor entry funnels of WAGO PCB terminal blocks fulfill this requirement.

WAGO recommends gas-tight tinned copper ferrules or tinned copper pin terminals when connecting fine-stranded conductors to terminal blocks in corrosive atmospheres.

## Electrical Engineering Laboratory Product Safety for Our Customers

To use terminal blocks globally, they must satisfy certain standards and obtain test certificates. These requirements apply to every manufacturer. WAGO also conducts its own tests to increase standards and offer greater reliability with its products. Products undergo a full range of mechanical, electrical and climatic testing, and we'll share a few of those processes with you.

### Pull-Out Test (per EN 60947-7-1, EN 60998-2-2)

During the pull-out force test, a conductor is pulled on until it is removed from the clamping unit. The design of the terminals means that extraction only occurs after the standard pull-out force has been exceeded many times over.

### WAGO Test Lab

This means that WAGO's products can be used safely and reliably both in Europe and anywhere globally for a wide variety of applications. We heavily emphasize the importance of global acceptance during development. As a result, we can present documentation that verifies our high levels of product safety and reliability while ensuring the fulfillment and accuracy of technical data, which are the highest priorities for our customers and users worldwide. On December 22, 2009, our test lab was accredited by the German Accreditation Association (Deutsche Gesellschaft für Akkreditierung GmbH) in accordance with DIN EN ISO/IEC 17025.



### Vibration Test (per IEC/EN 60068-2-6)

Depending on the application, such as railway (per EN 61373) or marine (per GL, LR, DNV), there are various testing requirements to determine if the long-term effects of vibrations degrade electrical connections. The test specimen is subjected to different loads on three axes in an electrodynamic vibration system. The amplitude, the acceleration, and particularly the frequency of the vibration vary during the test. The test values are increased many times over the standard values to meet special customer requirements.



### Shock Test (per IEC/EN 60068-2-27)

The shock test is very similar to the vibration test except that, instead of continuous vibrations, single shocks are applied to the test specimen. Shock tests are usually performed, for example, at an acceleration of 20g over a period of 11 ms. Tests for special requirements often call for much higher values and are also conducted in our laboratory.



### Voltage Drop Test under Bending Stress (per WAGO test requirements)

The voltage drop test under bending stress simulates mechanical stress on the clamping unit. In everyday use, this stress can occur during installation, for example, when an electrician shoves connected conductors to the side in order to access a specific component. The quality of the clamping unit when moving a connected conductor can be validated by the constantly stable measured value of the voltage drop.





## Deutsche Akkreditierungsstelle GmbH

Entrusted according to Section 8 subsection 1 AkkStelleG in connection with Section 1 subsection 1 AkkStelleGBV

Signatory to the Multilateral Agreements of EA, ILAC and IAF for Mutual Recognition

# Accreditation



The Deutsche Akkreditierungsstelle GmbH attests that the testing laboratory

**WAGO GmbH & Co. KG**  
**Hansastraße 27, 32423 Minden**

is competent under the terms of DIN EN ISO/IEC 17025:2018 to carry out tests in the following fields:

**Electrical and mechanical testing of terminals and connectors and environmental simulation**

The accreditation certificate shall only apply in connection with the notice of accreditation of 18.05.2022 with the accreditation number D-PL-19704-01. It comprises the cover sheet, the reverse side of the cover sheet and the following annex with a total of 9 pages.

Registration number of the certificate: **D-PL-19704-01-00**

Berlin,  
29.06.2022

Florian Burkart  
Head of Technical Unit

Translation issued:  
29.06.2022

Head of Technical Unit

*The certificate together with the annex reflects the status as indicated by the date of issue.*

*The current status of any given scope of accreditation can be found in the directory of accredited bodies maintained by Deutsche Akkreditierungsstelle GmbH at <https://www.dakks.de/en/accredited-bodies-search.html>.*

This document is a translation. The definitive version is the original German accreditation certificate.

See notes overleaf.

## WAGO-Seminars

### Learn Today – Benefit Tomorrow

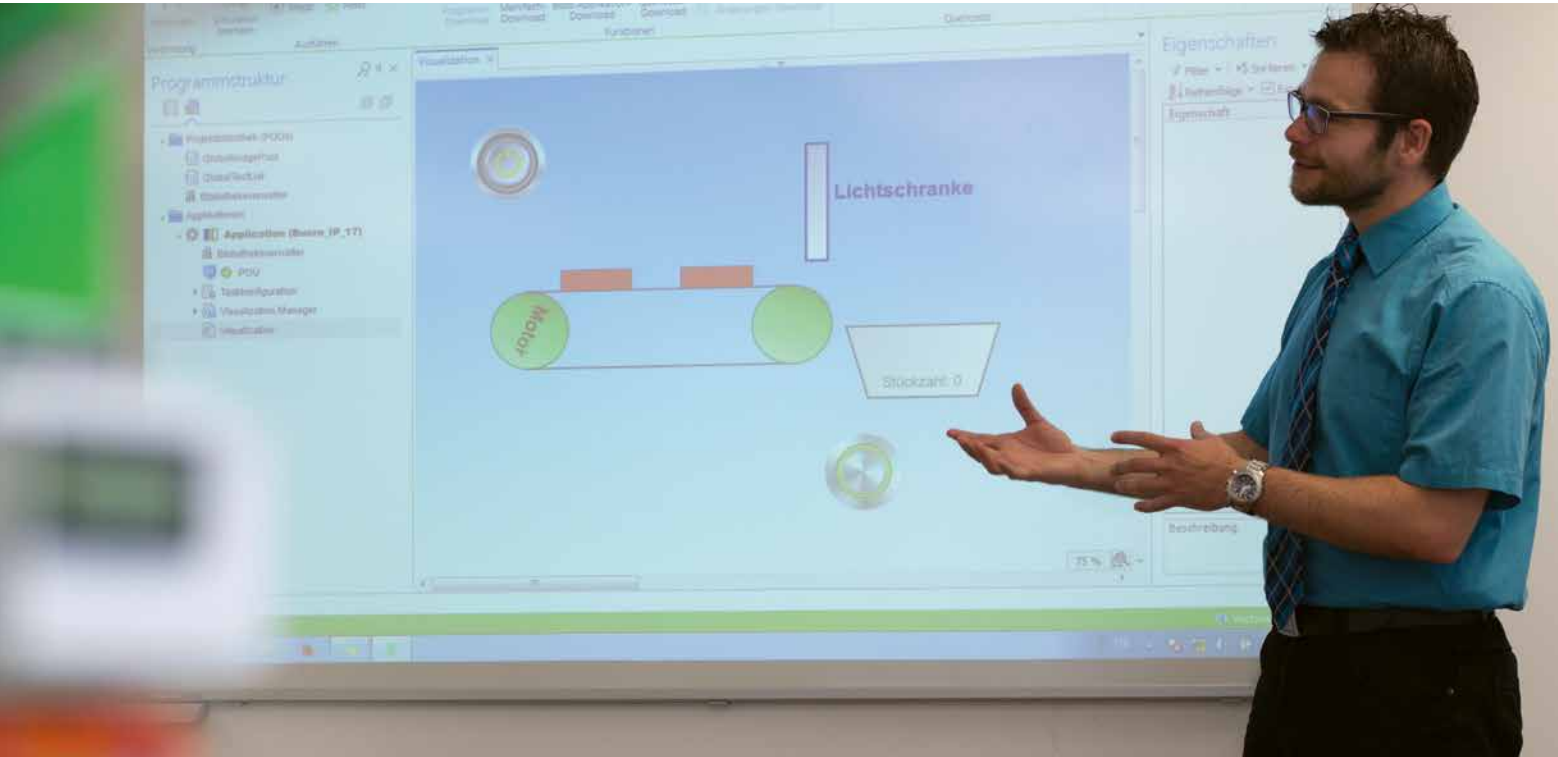

## Setting the Bar with Your Goals

### Product-Related and Customer-Specific Seminars



#### Small Groups

The small class sizes of WAGO training seminars ensures that no question goes unanswered and no one is overlooked.



#### Teamwork

Learning as a group is very effective. Ideas can be discussed and exchanged while experiences can be shared – all for the benefit of the participants.



#### Practical Topics

Experience has shown that practice makes perfect. This is why the focus of every WAGO training seminar is on practical, hands-on learning.

6

## WAGO-Seminars

Experience the Benefits of First-Hand Knowledge and Expertise – Straight from the Source

Our instructors are specialists who know all the ins and outs of WAGO's products. This ensures that the time devoted to each WAGO training seminar is an effective investment in expanding your own expertise.

Request your registration form by email:  
[training@wago.com](mailto:training@wago.com)

Contact your local  
WAGO office.

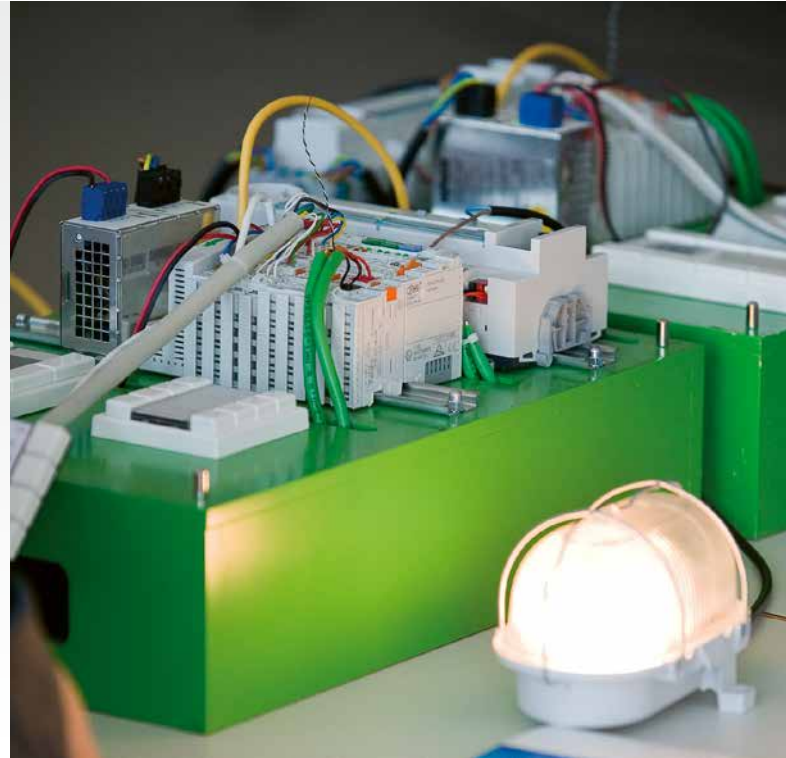

### Product-Related Seminars

We regularly offer product-related seminars on the following topics:

- Building and industrial automation
- Programming of automation components
- Fieldbus systems

Current Seminars at:  
[www.wago.com](http://www.wago.com)

### Customer-Specific Training Seminars

In addition to these "open" seminars, we also offer seminars specially tailored to your organization and its particular needs.

Upon request, we can also conduct these courses at your location.

Special  
Corporate Seminars

6

## Success for Generations: Environmental Protection at WAGO



At WAGO, we see environmental protection not only as compliance with environmental protection requirements.

As a growing company, our commitment to the environment drives our efforts to deliver new ideas, new concepts and new technologies along the product lifecycle. Here our employees and business partners support us.

### Corporate Environmental Protection

Business growth also leads to higher consumption of resources. We have realized that the economic success of a company also depends on the achievement of environmental goals.

As a manufacturing company, we therefore support developments that make a contribution to environmental protection. In doing so, we always pursue individual material flows along the value chain, because we see resources, product design, production and consumption as a whole.

With our environmental management system certified in accordance with DIN EN ISO 14001, we ensure that the required national and international requirements are complied with in all areas of the company and that the concept of environmental protection is practiced in all corporate processes. In addition, WAGO is pursuing further efforts in the field of environmental protection that go far beyond the requirements of ISO.

Some examples include the recycling of plastics, resource savings on product and packaging materials, the use of recycled paper throughout the company, the introduction of e-filling stations and the use of waste heat from production processes.

### Product-Related Environmental Protection

Product-related environmental protection is an important part of sustainable environmental management at WAGO. Ensuring compliance with substance bans / restrictions worldwide, such as: As REACH, RoHS has a high priority.

#### RoHS – Restriction of the Use of Certain Hazardous Substances

It is an EC directive that regulates the use of certain hazardous substances in electrical and electronic equipment. In addition to reducing the harmful effects on humans and the environment, legislation aims to improve recycling possibilities. WAGO closely monitors the development regarding RoHS and reacts promptly to specifications accordingly. For more information about RoHS please contact us via [ehs-product-compliance@wago.com](mailto:ehs-product-compliance@wago.com).

RoHS   
Compliant

## Success for Generations: Environmental Protection at WAGO

### REACH – Registration, Evaluation and Authorisation of Chemicals

On 01.06.2007 the regulation (EC) no. 1907/2006 (REACH regulation) came into force and since then forms a valid legal basis for all EU member states. To protect human health and the environment, this EU Chemicals Regulation aims to classify and identify all chemicals, including their effects.

The REACH Regulation creates specific obligations for each actor in the supply chain. The products manufactured by WAGO are to be designated as products in the sense of the regulation. Since products are not subject to registration, WAGO usually assumes the role of the downstream user in the supply chain. WAGO therefore has an obligation to provide information along the supply chain in accordance with REACH Article 33. WAGO is naturally aware of this obligation.

**BOMcheck**.net

For more information about our reporting requirements according to REACH Article 33 please visit our website "REACH SVHC Declaration" via [www.wago.com/svhc](http://www.wago.com/svhc)

### BOMcheck

European legislation such as REACH or RoHS requires the provision of information on restricted ingredients in products. This information must be shared by manufacturers and suppliers in the supply chain. WAGO meets this challenge in product-related environmental protection successfully and efficiently with BOMcheck.

BOMcheck is a centralized database for the declaration of ingredients. It is a compliance tool specifically designed to enable manufacturers and suppliers to produce their substance declarations under REACH, RoHS, and other restrictions on ingredients in an efficient and structured manner. This Internet database system increases data quality in the area of product-related environmental protection.

Further information on BOMcheck can be found at the following link: <http://www.bomcheck.net>

### WEEE – Waste of Electrical and Electronic Equipment

The WEEE Directive 2012/19/EU regulates the take-back and recycling of electrical and electronic equipment. Manufacturers and importers of electrical and electronic equipment are obliged to register as a 'WEEE producer' and to comply with the reporting and take-back obligations. As a matter of course, we have taken compliance with legal WEEE requirements very seriously all the time - in our own interest as well as in the well-understood interest of our customers.

Only some of our products fall within the scope of the WEEE Directive and the Member State's implementation laws. These products are WEEE-compliant marked by us, as far as such a marking is legally required (which is not required for the B2B area Europe-wide).

For more information about WEEE please contact us via [ehs-product-compliance@wago.com](mailto:ehs-product-compliance@wago.com).

### Less is More: Our Packaging

Recycling is the basis for choosing our packaging materials. All packaging used by WAGO can be recycled in the economic cycle without further pretreatment. In addition to the aspect of recycling, emphasis is placed on resource conservation. For this reason, our cardboard boxes consist of 80% recycled paper and are marked with the Resy symbol. The Resy symbol guarantees compliance with the Packaging Ordinance for transport packaging. The labeling is partly done by perforation. This process enables the colorless printing of WAGO cardboard boxes. This avoids unnecessary environmental pollution.



# Indexes

## Indexes

	Page
Item Number Index	168

## Newly added items in this catalog

207-1375  
207-5465/316-000  
221-509

221-519  
221-529  
221-539

221-549  
887-1127  
887-1150

887-1152  
887-1159

## Items discontinued in this catalog

887-913

## Item Number Index

Item No.	Page	Item No.	Page	Item No.	Page	Item No.	Page
<b>206 Series</b>		<b>221 Series</b>		<b>221 Series</b>		<b>773 Series</b>	
206-1125	110	221-420	15	221-942/000-006	7	773-606	45
206-1126	110	221-422	7	221-2401	19		
206-1127	110	221-423	7	221-2411	19	<b>873 Series</b>	
206-1128	110	221-425	7	221-2421	11	873-902	60
206-1129	110	221-430	7	221-2431	11	873-903	60
206-1131	110	221-482	23	221-2501	11	873-953	61
206-1132	110	221-483	23	221-2502	11		
206-1141	111	221-485	23	221-2503	11	<b>887 Series</b>	
206-1400	108	221-490	23	221-2504	11	887-802	84
206-1403	108	221-500	7	221-2505	11	887-803	84
206-1411	108	221-500/000-006	7	221-2511	11	887-804	84
206-1412	108	221-500/000-053	7	221-2512	11	887-805	85
206-1413	108	221-501	23	221-2513	11	887-850	79
206-1414	108	221-502	93	221-2514	11	887-851	79
206-1415	108	221-502/000-004	93	221-2515	11	887-853	79
206-1418	108	221-503	93	221-2521	11	887-925	76
206-1419	108	221-503/000-004	93	221-2522	11	887-926	76
206-1441	109	221-505	93	221-2523	11	887-927	76
206-1442	109	221-505/000-004	93	221-2524	11	887-928	77
206-1451	109	221-509	94	221-2525	11	887-931	77
206-2101	107	221-509/000-006	94	221-2531	11	887-932	77
206-2102	107	221-509/000-053	94	221-2532	11	887-934	78
206-2111	106	221-509/002-000	94	221-2533	11	887-952	80
206-2112	106	221-509/002-006	94	221-2534	11	887-953	80
206-2113	106	221-509/002-053	94	221-2535	11	887-955	80
206-2114	106	221-510	9			887-957	81
206-2115	106	221-510/000-006	9	<b>222 Series</b>		887-959	81
206-2116	106	221-510/000-053	9	222-412	29	887-960	81
206-2117	106	221-511	25	222-413	29	887-1127	78
206-2120	106	221-512	93	222-415	29	887-1150	82
206-2121	106	221-512/000-004	93	222-500	29	887-1152	82
206-2122	106	221-513	93	222-505	89	887-1159	82
206-2123	106	221-513/000-004	93	222-510	89		
206-2130	106	221-515	93			<b>2273 Series</b>	
206-2131	106	221-515/000-004	93	<b>224 Series</b>		2273-202	37
206-2132	106	221-519	94	224-101	31	2273-203	37
206-2133	106	221-519/000-006	94	224-104	31	2273-204	37
206-2141	107	221-519/000-053	94	224-112	31	2273-205	37
206-2142	107	221-519/002-000	94	224-114	31	2273-208	37
206-2142	107	221-519/002-006	94	224-201	31	2273-500	37
206-2151	107	221-519/002-053	94				
206-2152	107	221-522	93	<b>243 Series</b>			
206-2163	107	221-522/000-004	93	243-110	105	<b>2773 Series</b>	
206-2164	107	221-523	93	243-112	57	2773-2401	39
206-2165	107	221-523/000-004	93	243-113	57		
206-2166	107	221-525	93	243-144	57		
206-2167	107	221-525/000-004	93	243-204	59		
206-2169	107	221-529	94	243-208	59		
		221-529/000-006	94	243-304	59		
<b>207 Series</b>		221-529/000-053	94	243-308	59		
207-1331	65	221-529/002-000	94	243-504	59		
207-1332	65	221-529/002-006	94	243-508	59		
207-1333	65	221-529/002-053	94	243-804	59		
207-1372	69	221-539	95	243-808	59		
207-1373	69	221-539/000-006	95				
207-1375	69	221-539/000-053	95	<b>249 Series</b>			
207-1431	66	221-539/002-000	95	249-130	112		
207-1432	66	221-539/002-006	95				
207-1433	66	221-539/002-053	95	<b>773 Series</b>			
207-4301	71	221-539/1000-000	95	773-102	43		
207-5465/316-000	73	221-539/1002-000	95	773-104	43		
207-5485/316-000	73	221-549	95	773-106	43		
207-9301	71	221-549/000-006	95	773-108	43		
		221-549/000-053	95	773-112	43		
<b>209 Series</b>		221-549/002-000	95	773-116	43		
209-119	97	221-549/002-053	95	773-118	43		
209-120	97	221-549/1000-000	95	773-124	43		
209-123	97	221-549/1002-000	95	773-173	47		
209-1115	97	221-612	17	773-331	51		
209-1116	97	221-613	17	773-332	43		
		221-615	17	773-492	51		
<b>210 Series</b>		221-622	9	773-493	53		
210-334	89	221-623	9	773-493	53		
		221-625	9	773-494	51		
<b>221 Series</b>		221-682	25	773-496	51		
221-412	15	221-683	25	773-498	51		
221-413	15	221-685	25	773-514	49		
221-415	15	221-941	7	773-602	45		
		221-941/000-006	7	773-604	45		
		221-942	7				

**WAGO GmbH & Co. KG**

Postfach 2880 · D · 32385 Minden  
Hansastraße 27 · D · 32423 Minden

[info@wago.com](mailto:info@wago.com)

[www.wago.com](http://www.wago.com)

Headquarters +49 571 887 - 0  
Sales +49 571 887 - 44222  
Order Service +49 571 887 - 44333

Current addresses at [www.wago.com](http://www.wago.com)

**WAGO is a registered trademark of WAGO Verwaltungsgesellschaft mbH.**

"Copyright – WAGO GmbH & Co. KG – All rights reserved.

The content and structure of the WAGO websites, catalogs, videos and other WAGO media are subject to copyright. Distribution or modification to the contents of these pages and videos is prohibited. Furthermore, the content may neither be copied nor made available to third parties for commercial purposes. Also subject to copyright are the images and videos that were made available to WAGO GmbH & Co. KG by third parties."